



Friends™



41123





LEGO.com/friends

 **WARNING: CHOKING HAZARD.**
Small parts. Not for children under 3 years.

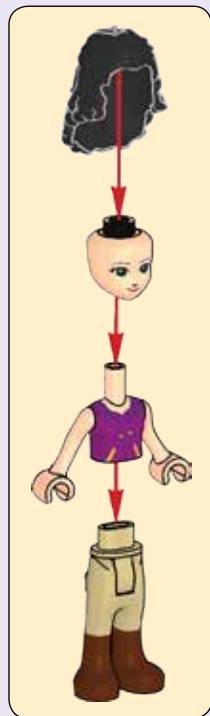

1



AVERTISSEMENT :
RISQUE D'ÉTOUFFEMENT.
Contient des petites pièces.
Ne convient pas aux enfants
de moins de 3 ans.



ADVERTENCIA:
PELIGRO DE ASFIXIA.
No recomendado para
niños menores de 3 años.
Contiene piezas pequeñas.

2



1x

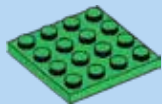

1x

1



1x

2

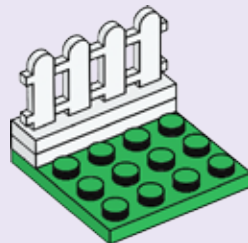



3

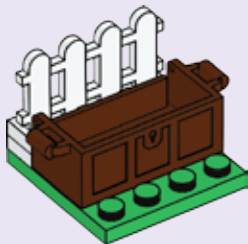

4



4

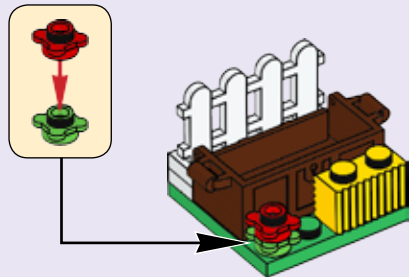



5

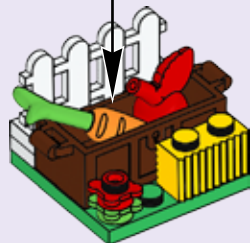
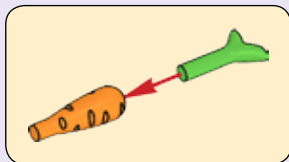



1x

6



6



4x

7

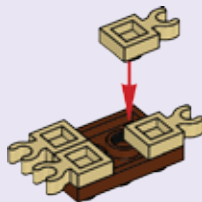



2x

8



9

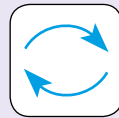
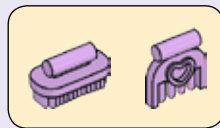



10

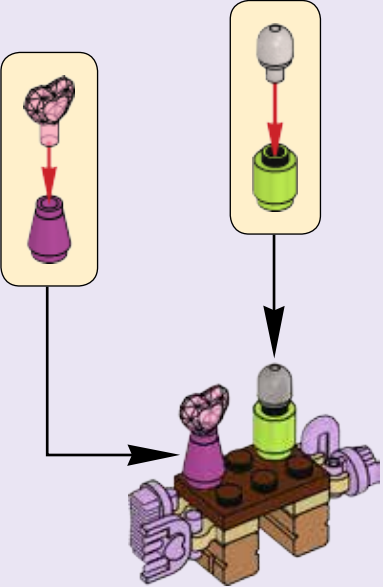

11

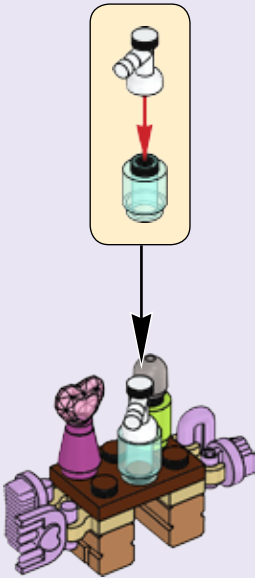



1

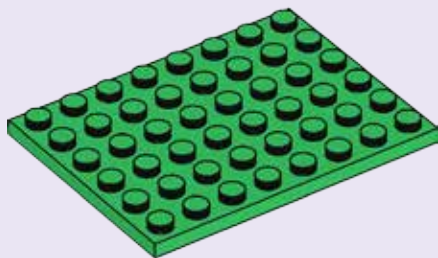



2x

2

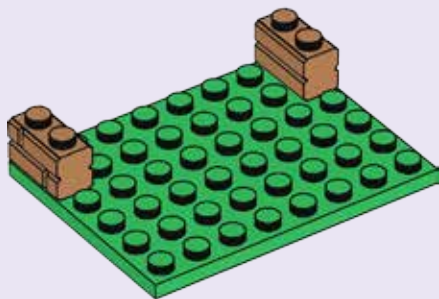

2x

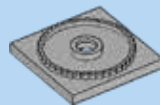

1x

3

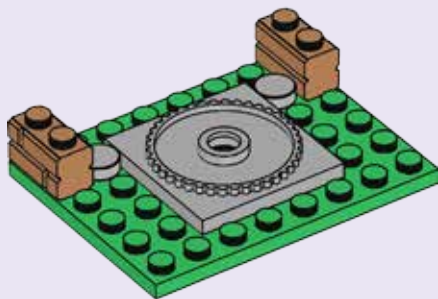



4

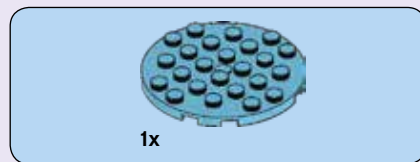
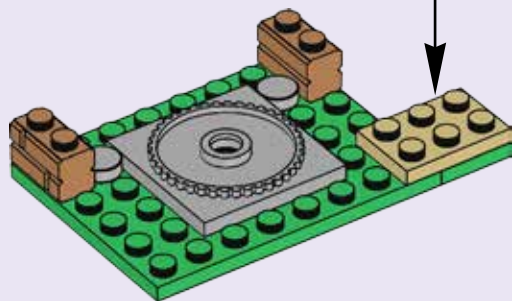

5

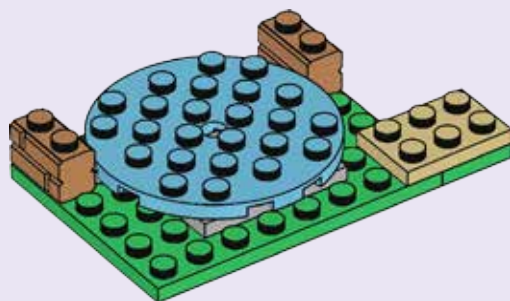



2x

6

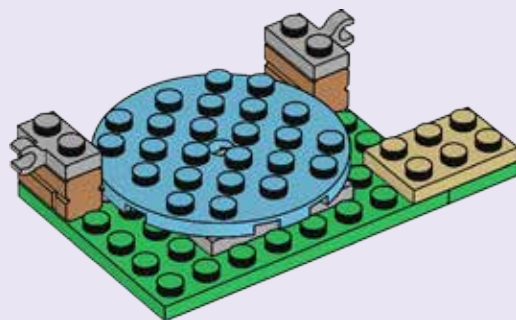



7

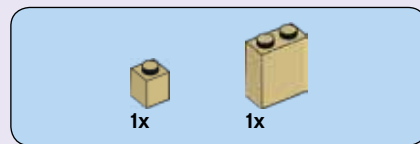
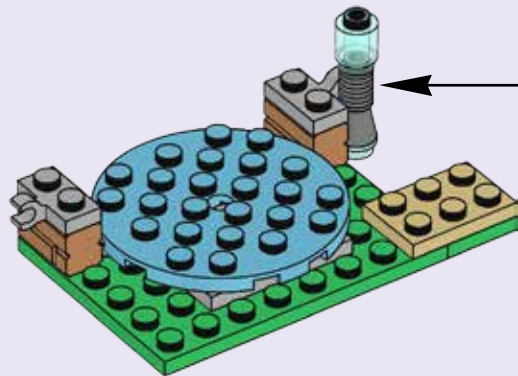
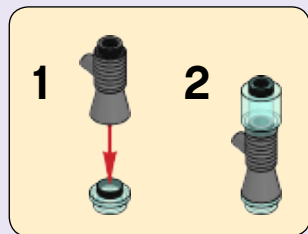

8

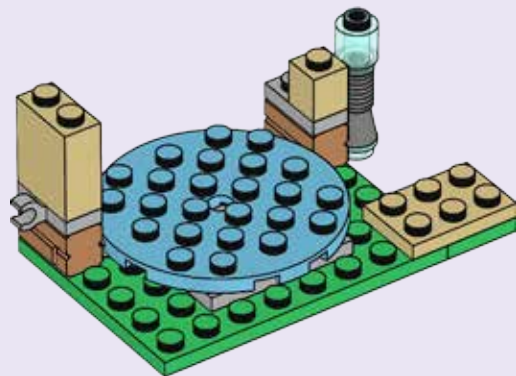



9

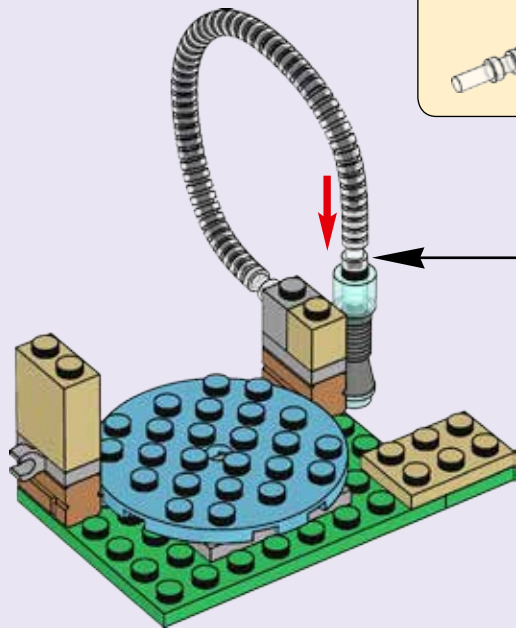
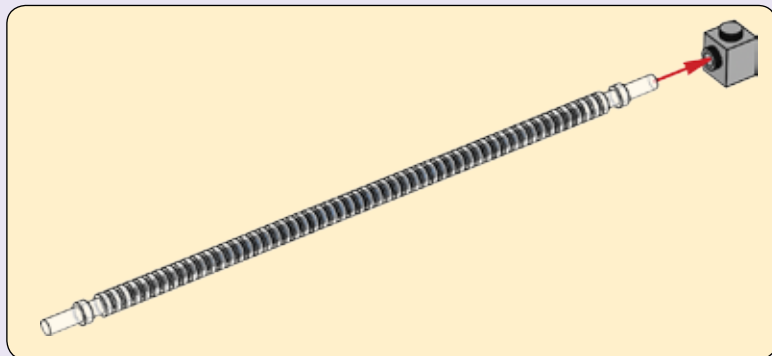

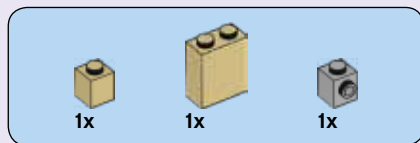

10

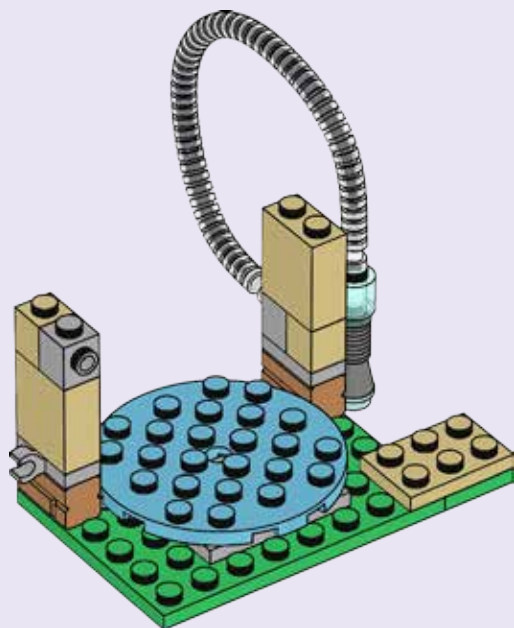

11

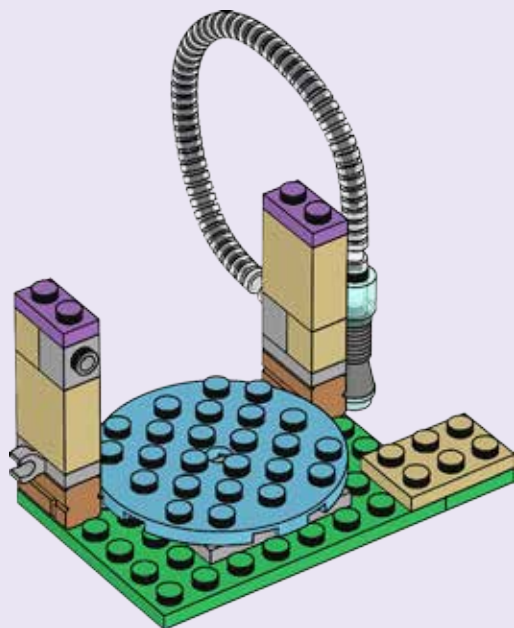

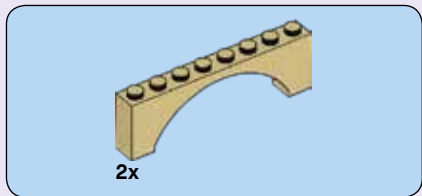

12

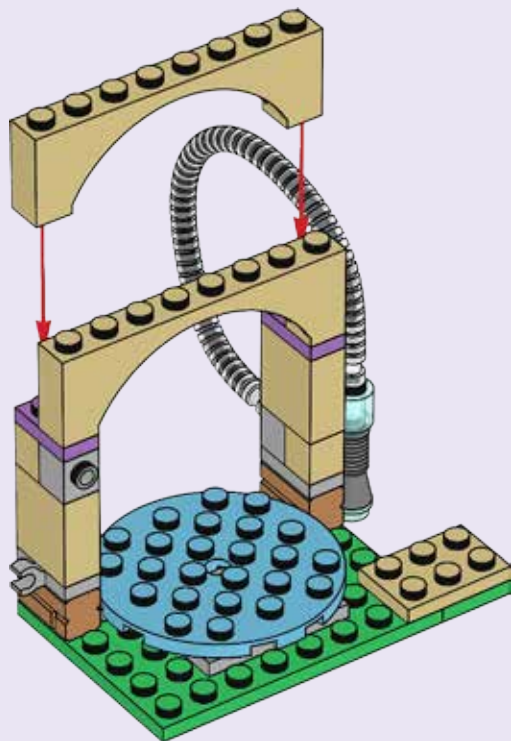



13

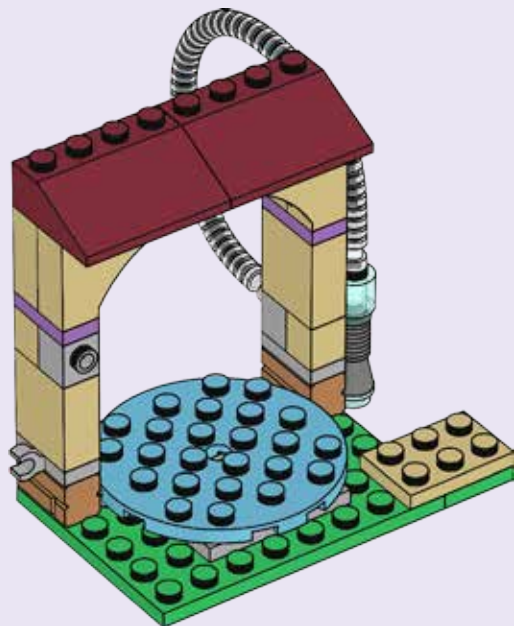

14

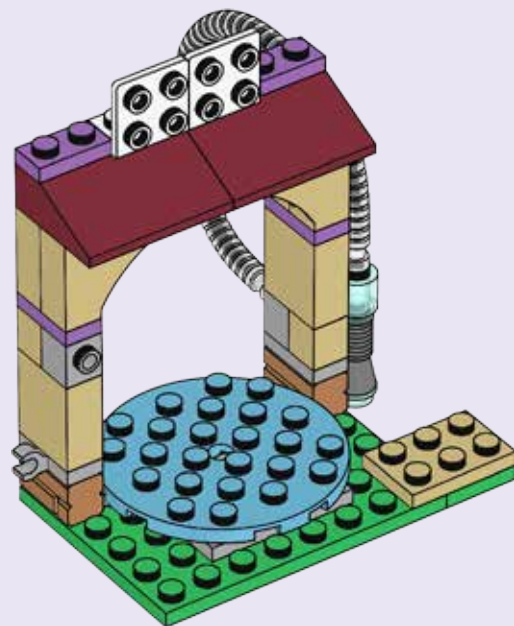

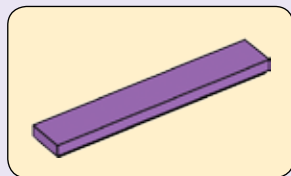
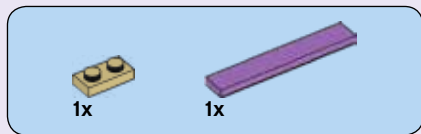

15

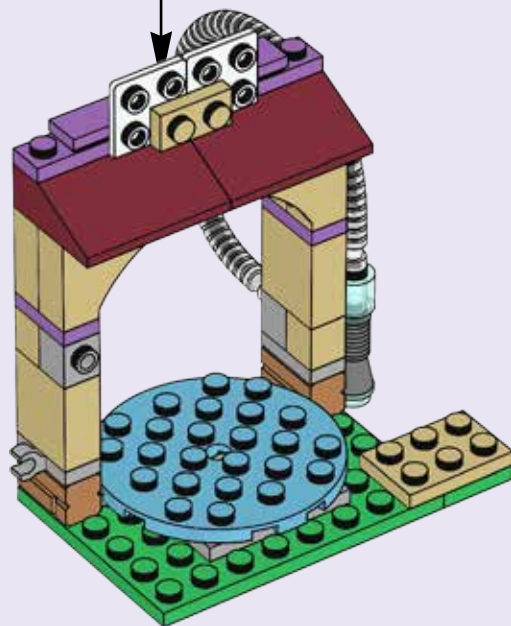

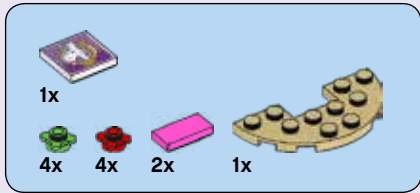

16

1

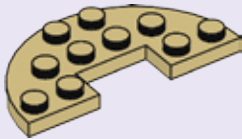

2



3

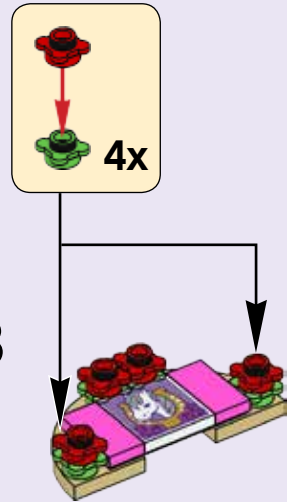

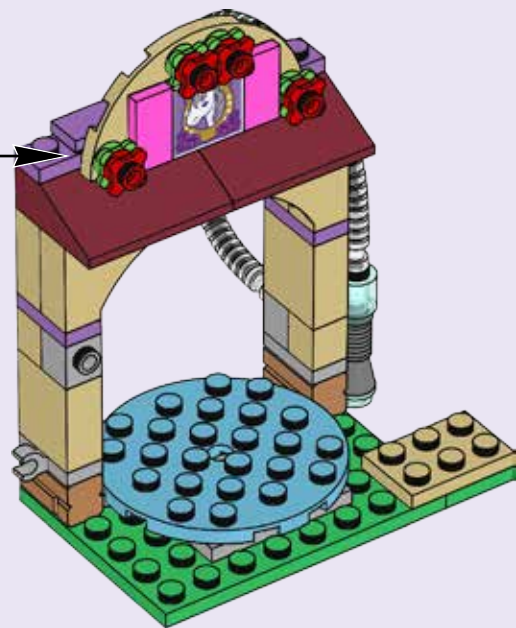



1x



1x



1x

17

1

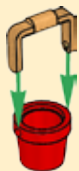

2

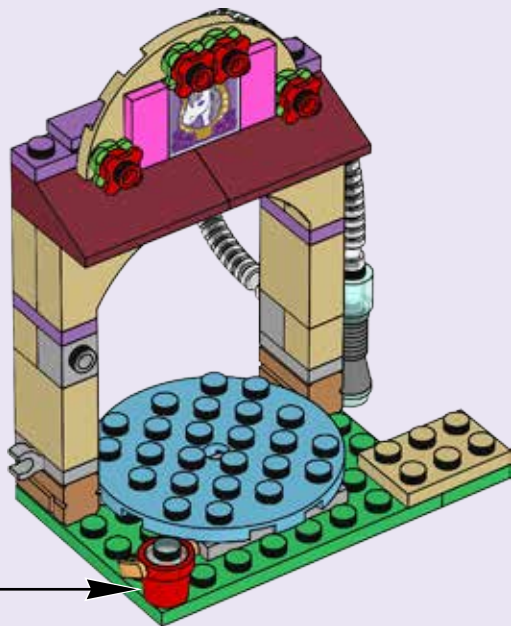

18

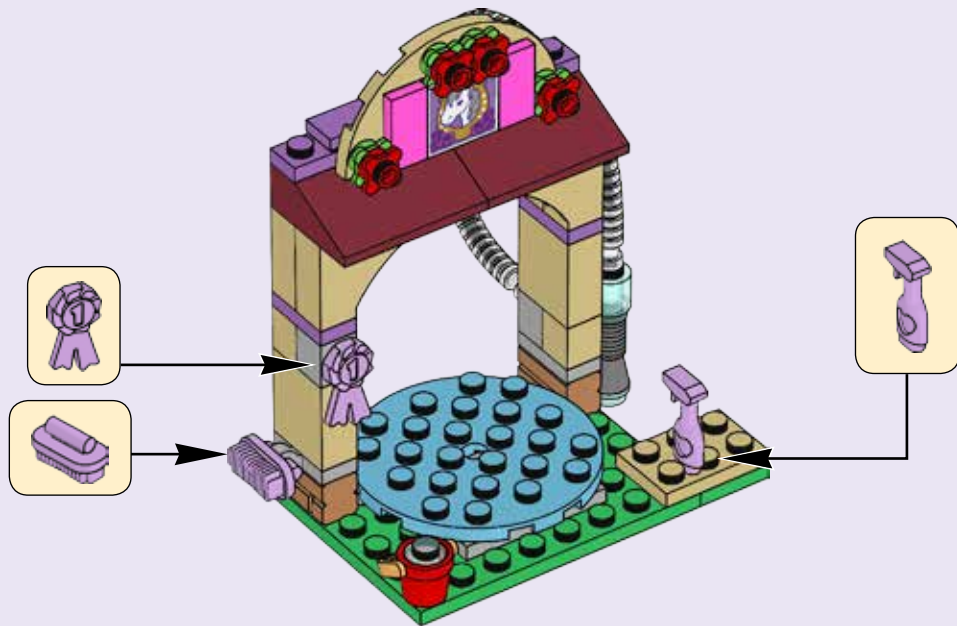

19





Friends™



41123



41125



41126



41124



41118



41119



Customer Service

**Kundenservice
Service Consommateurs
Servicio Al Consumidor**

LEGO.com/service or dial



: 00800 5346 5555

: 1-800-422-5346





Friends™



LEGO.com/friends



Google Play is a trademark of Google Inc. Google Play est une marque de commerce de Google Inc. Google Play es una marca comercial de Google Inc. Apple, the Apple logo and iPad are trademarks of Apple Inc. Apple, le logo Apple et iPad sont des marques de commerce d'Apple Inc. Apple, el logotipo de Apple e iPad son marcas comerciales de Apple Inc.

WIN

GO TO WWW.LEGO.COM/PRODUCTFEEDBACK AND
GIVE US YOUR SHORT **FEEDBACK** ABOUT THIS
LEGO® SET FOR A CHANCE TO WIN
A COOL LEGO PRIZE.

Terms & Conditions apply



LEGO.com/productfeedback

GEWINNE



Erzähle uns auf
www.LEGO.com/productfeedback

etwas über die Erfahrungen, die du mit
diesem LEGO® Set gemacht hast, und
sichere dir die Chance auf einen coolen
LEGO Preis!

Es gelten die Teilnahmebedingungen

GAGNE



Rends-toi sur
www.LEGO.com/productfeedback

et donne-nous quelques commentaires sur
ce produit LEGO® pour avoir une chance
de gagner un prix LEGO !

Voir Conditions Générales

GANAN



Visita
www.LEGO.com/productfeedback

y envíanos tu opinión acerca de este set
LEGO®. ¡Participarás en el sorteo de un
premio LEGO!

Términos y Condiciones aplicables

获取奖品



登录
www.LEGO.com/productfeedback

给出关于此乐高®套装的简短反馈，
就有机会获得炫酷乐高奖品

《条款及条件》适用

LEGO, the LEGO logo and the FRIENDS logo are trademarks of the/son des marques de commerce du/son marcas registradas de LEGO Group.
©2016 The LEGO Group. All rights reserved/Tous droits réservés/Todos los derechos reservados.

6174140