



# BIONICLE

71310







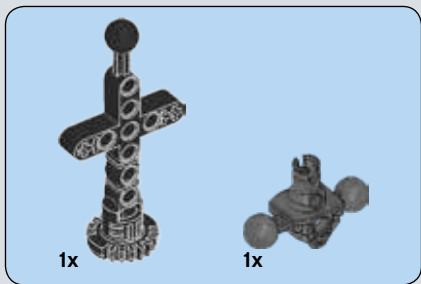

1

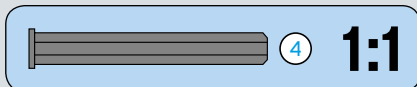
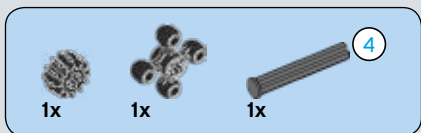
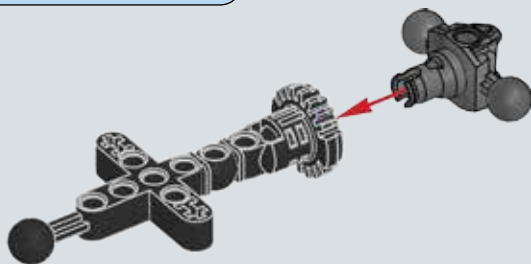

2

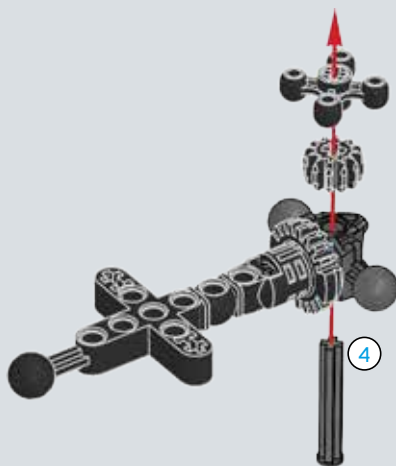

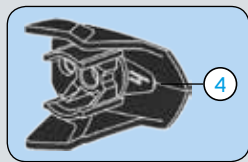
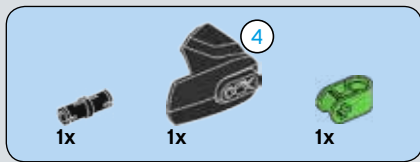

3

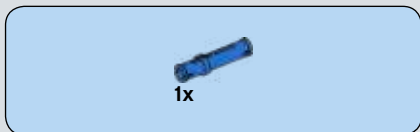
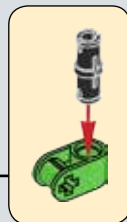
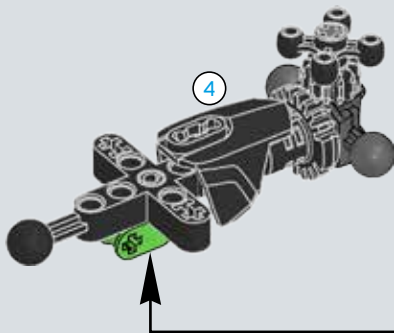

4

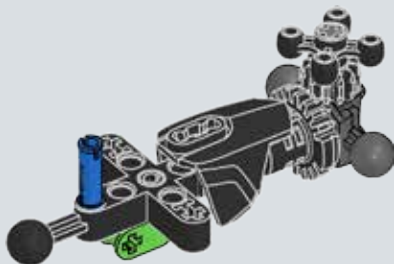

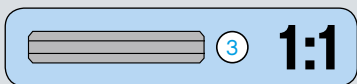
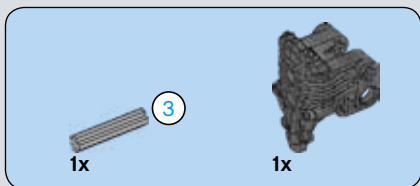

5

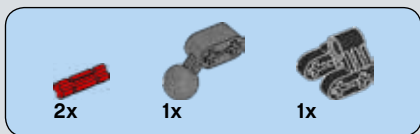
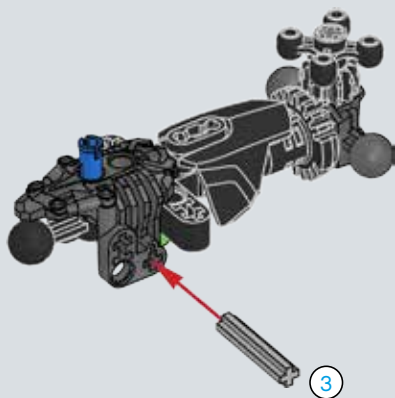

6

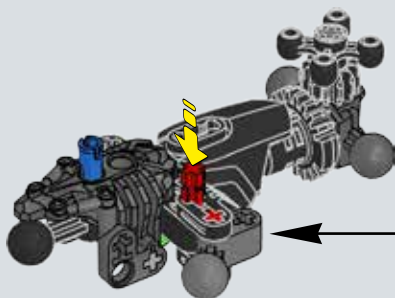

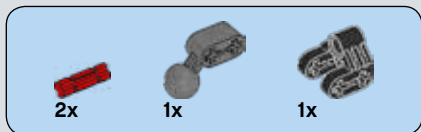

7

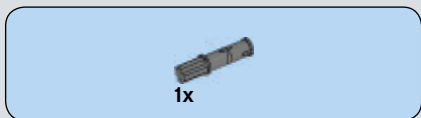
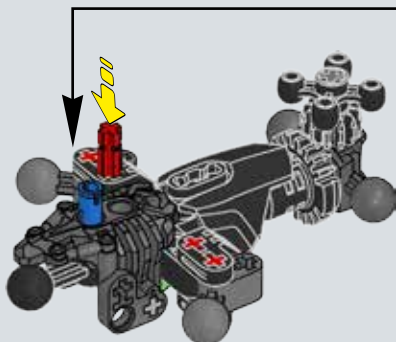

8

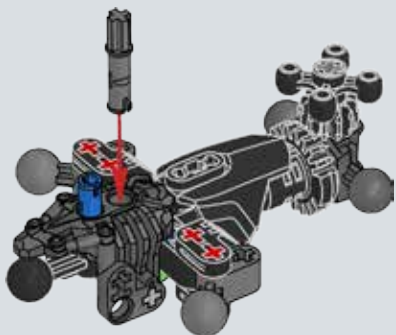

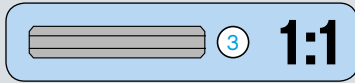
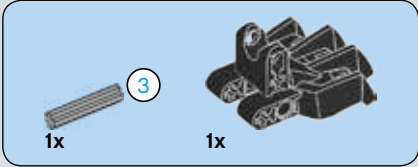

9

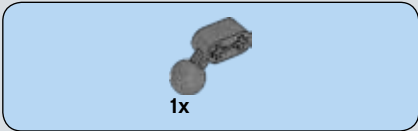
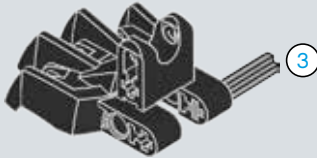

10

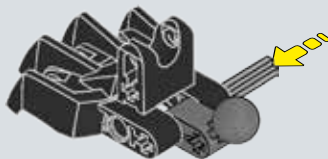





# 11

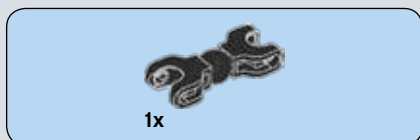
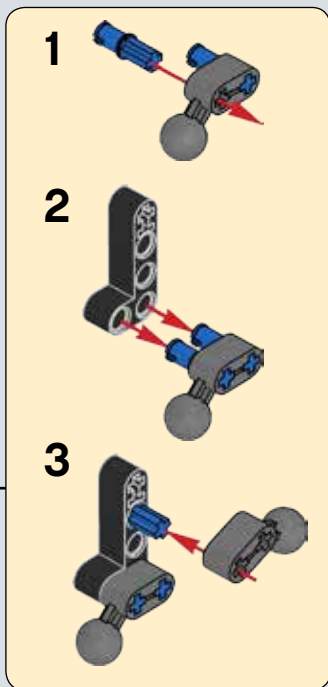
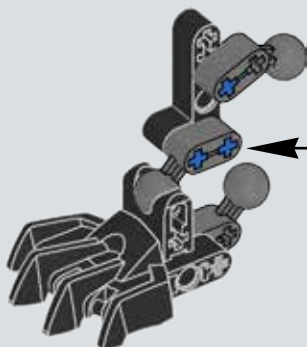

# 12

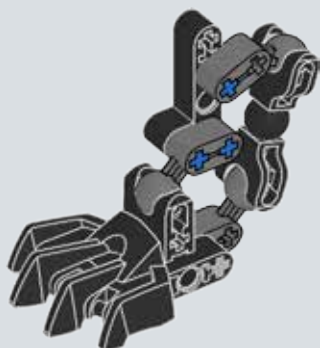

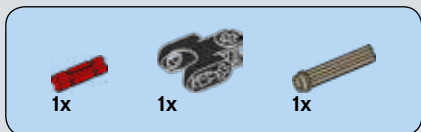

13

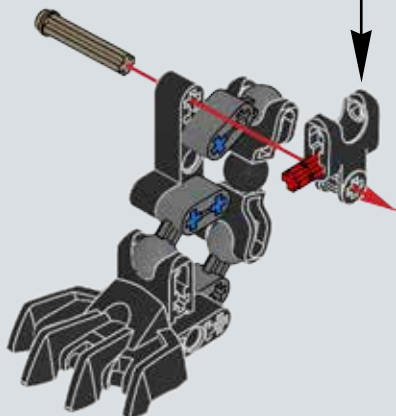
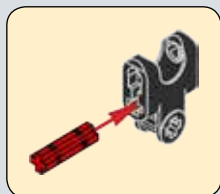

14

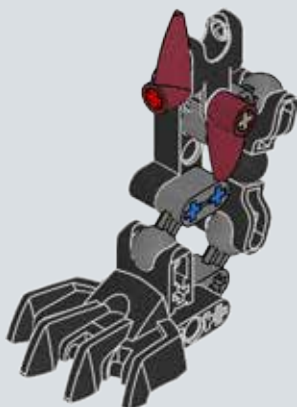

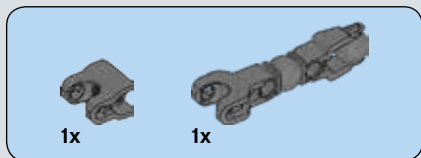

15

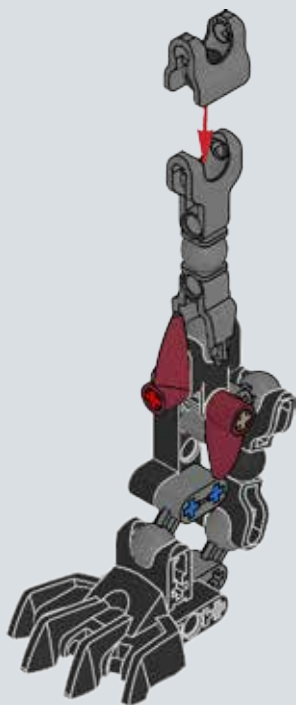

16

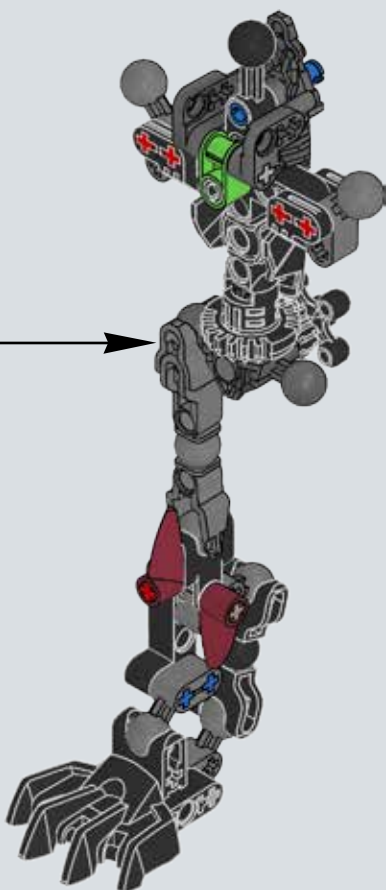

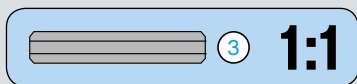
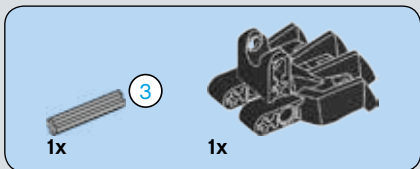

17

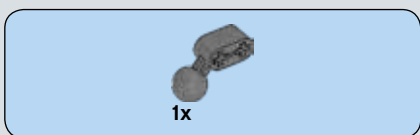
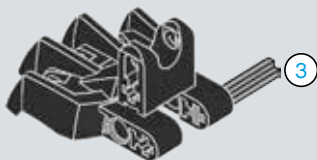

18

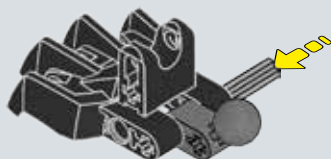



# 19

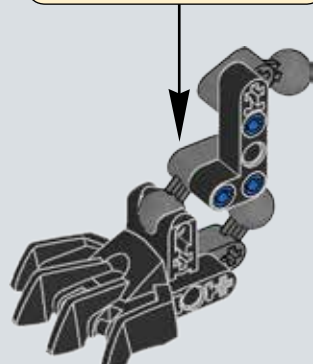
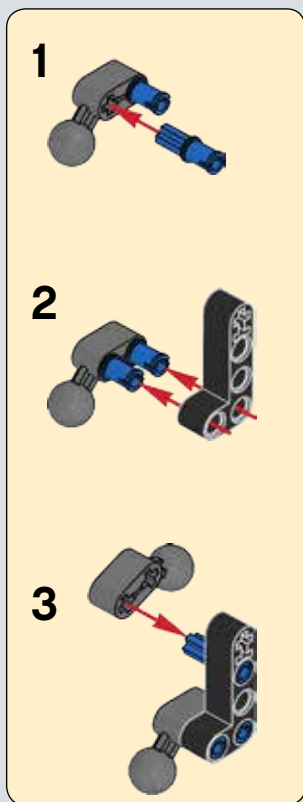



1x

# 20

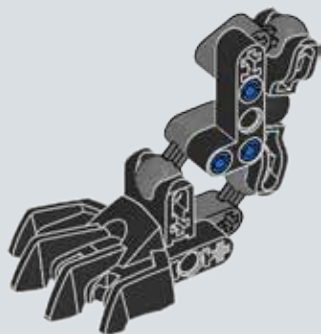

1x



1x



1x

# 21

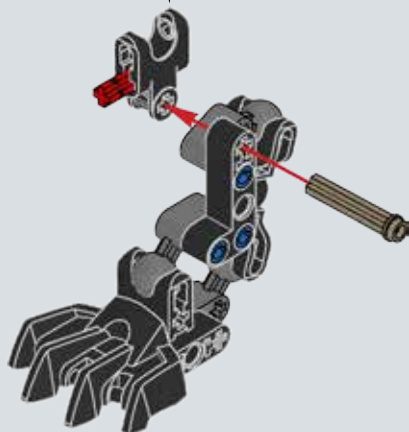
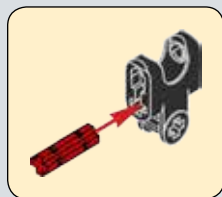



2x

# 22

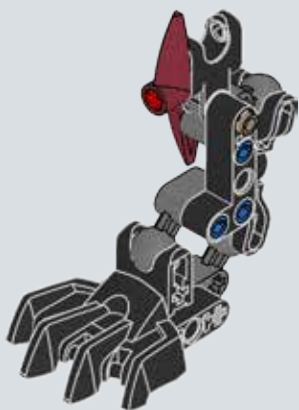

1x

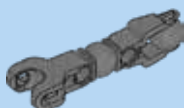

1x

# 23

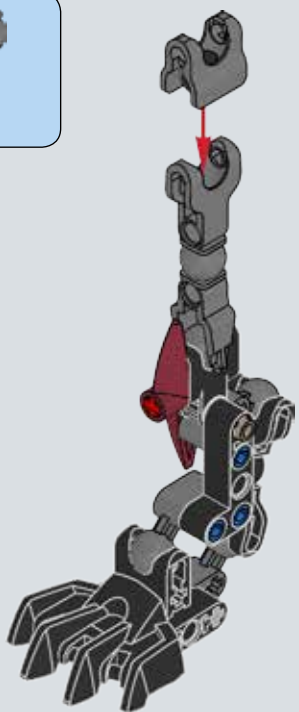

24

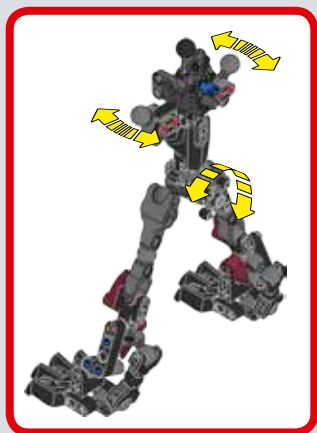
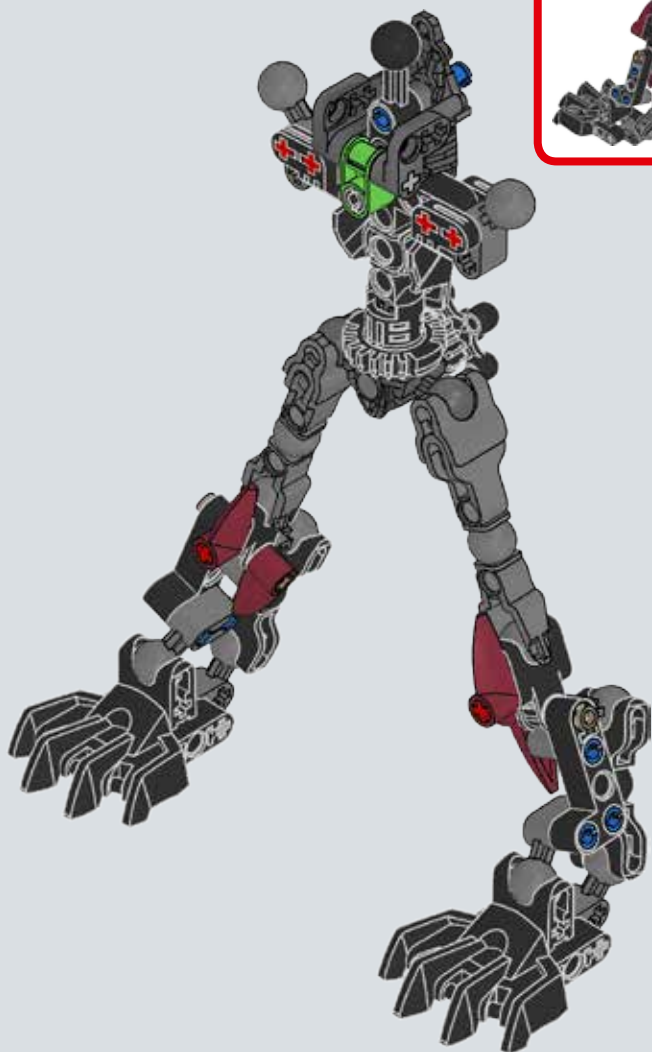



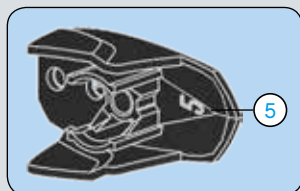

# 25

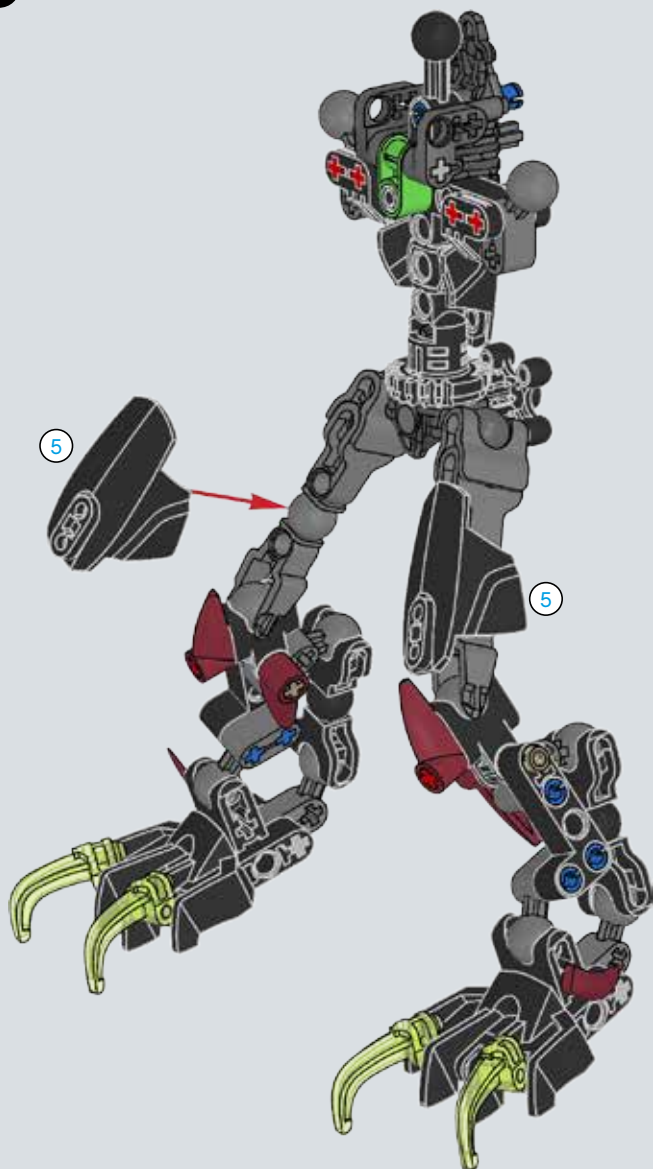

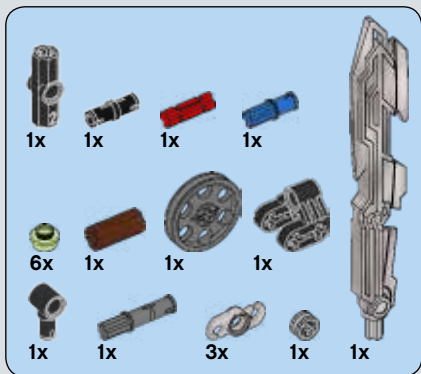

**26**

**1**



**2**

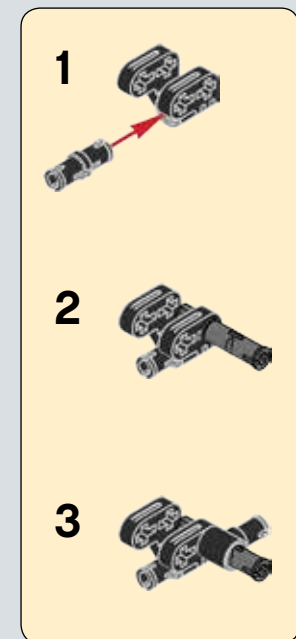

**3**

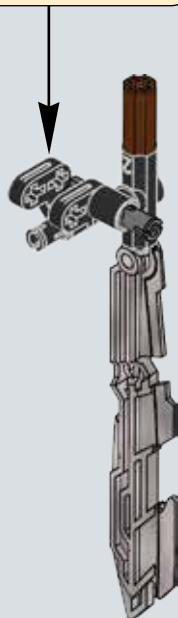

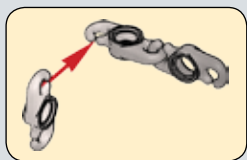

**4**

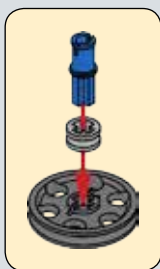
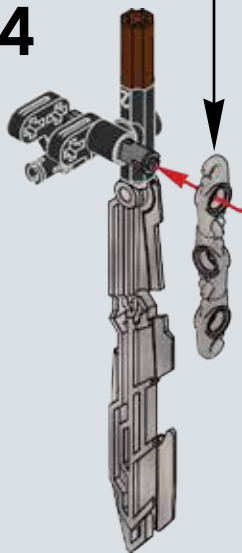

**5**

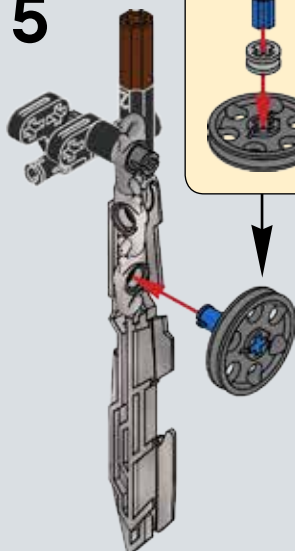

**6**

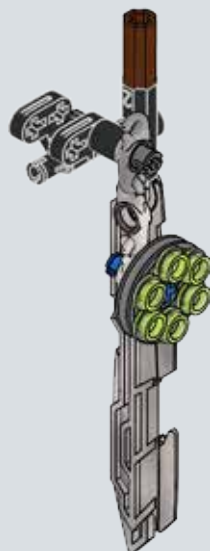

27

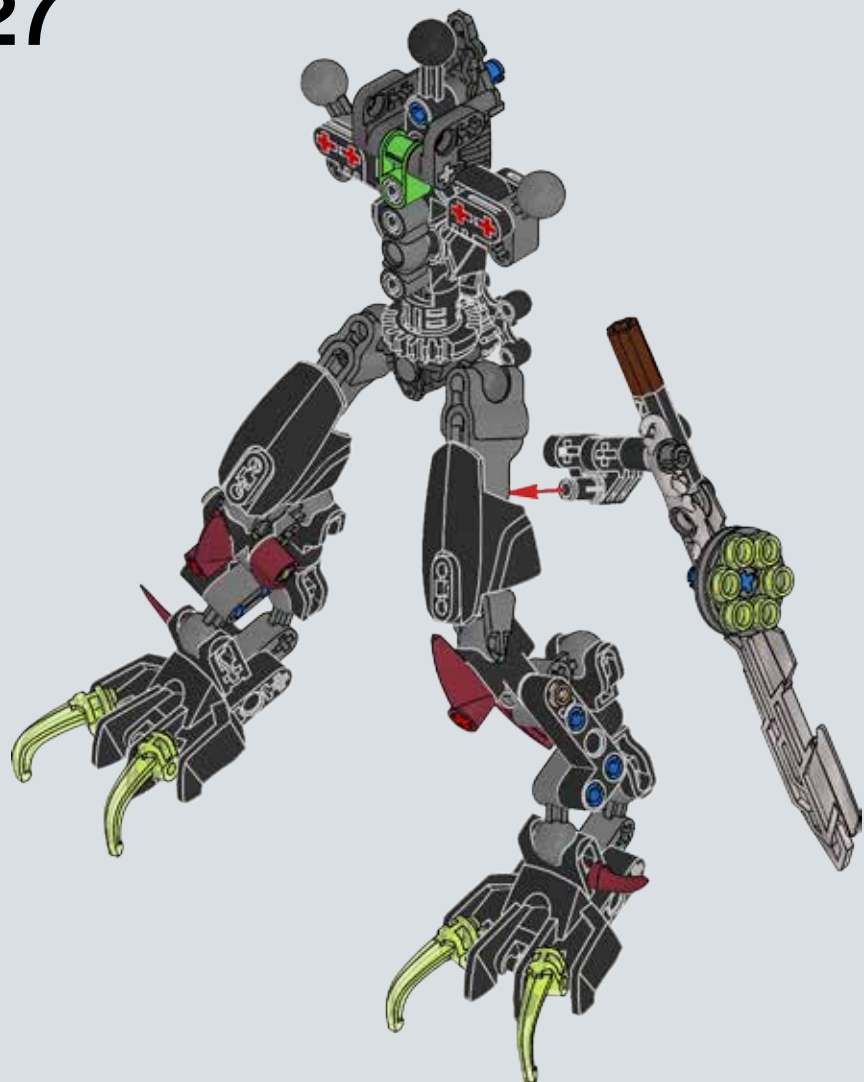



2x



1x

# 28

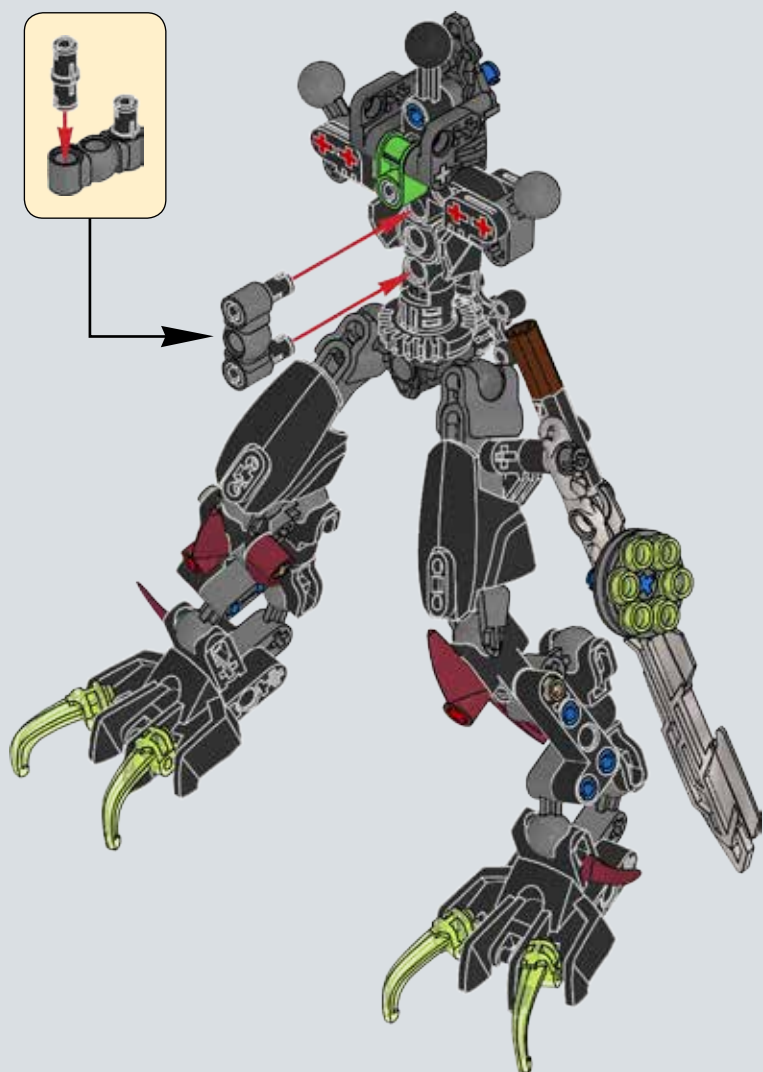



29

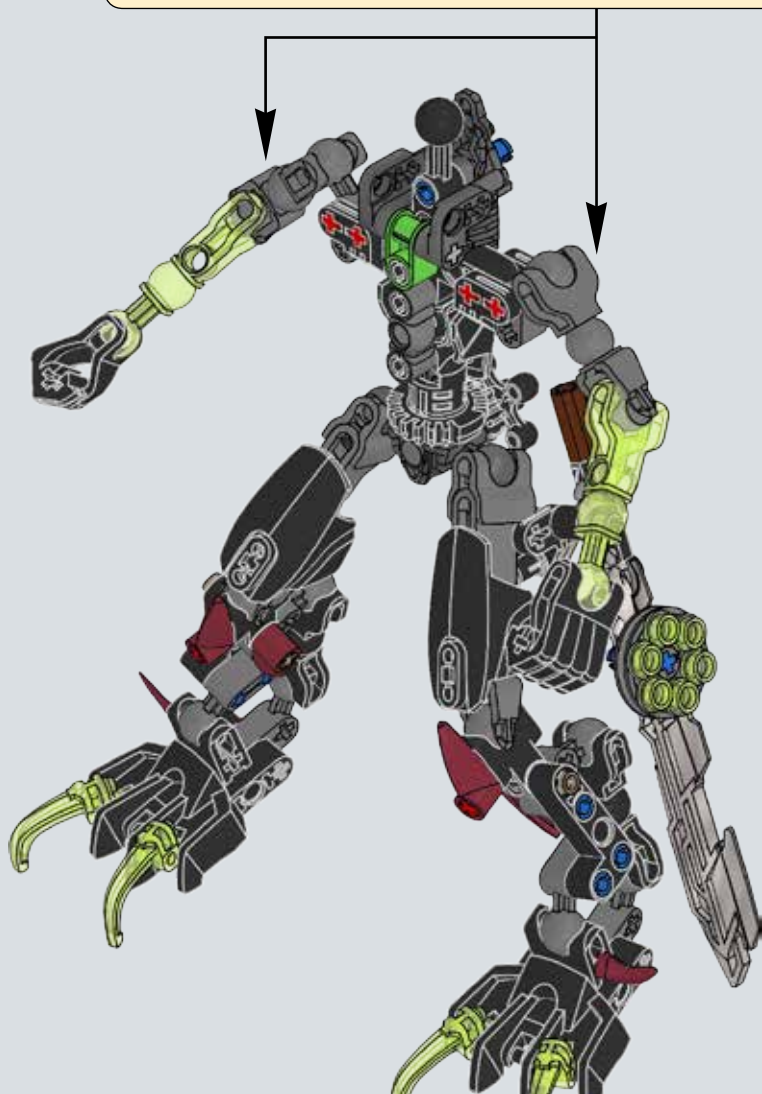
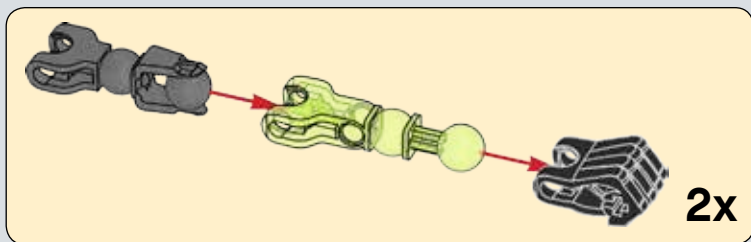

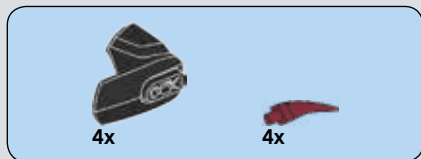

30

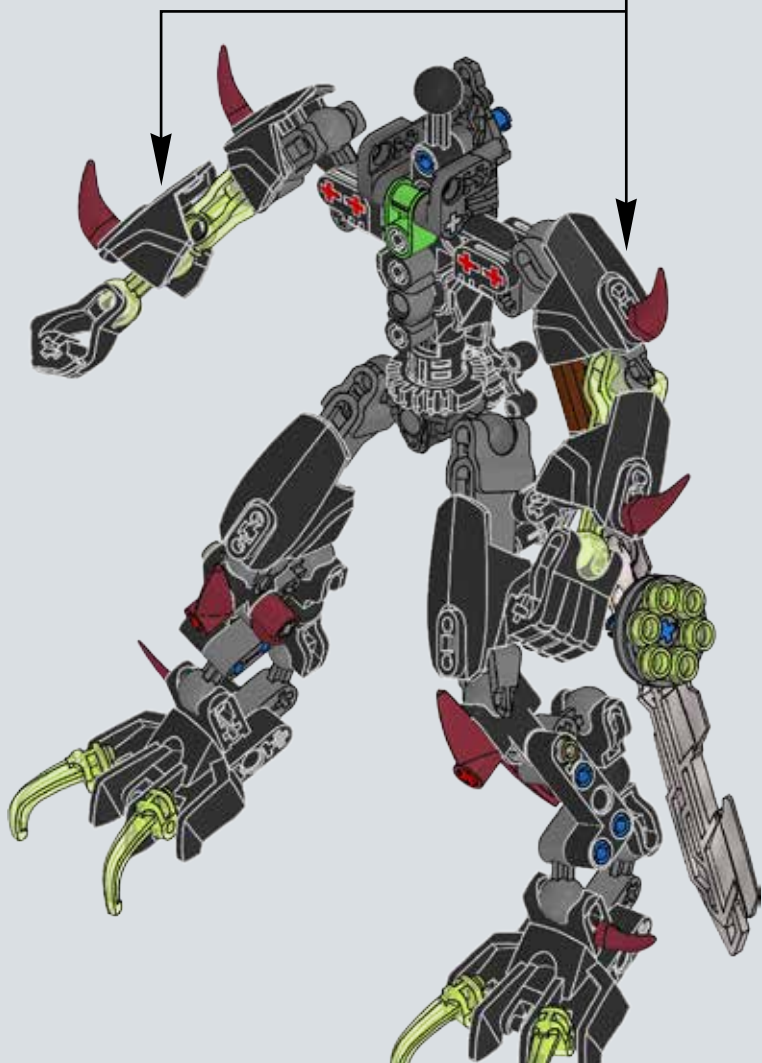



2x

# 31





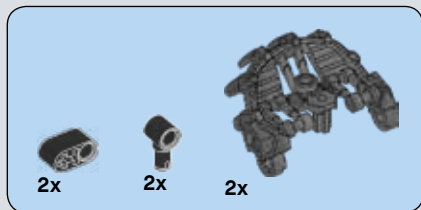

# 32

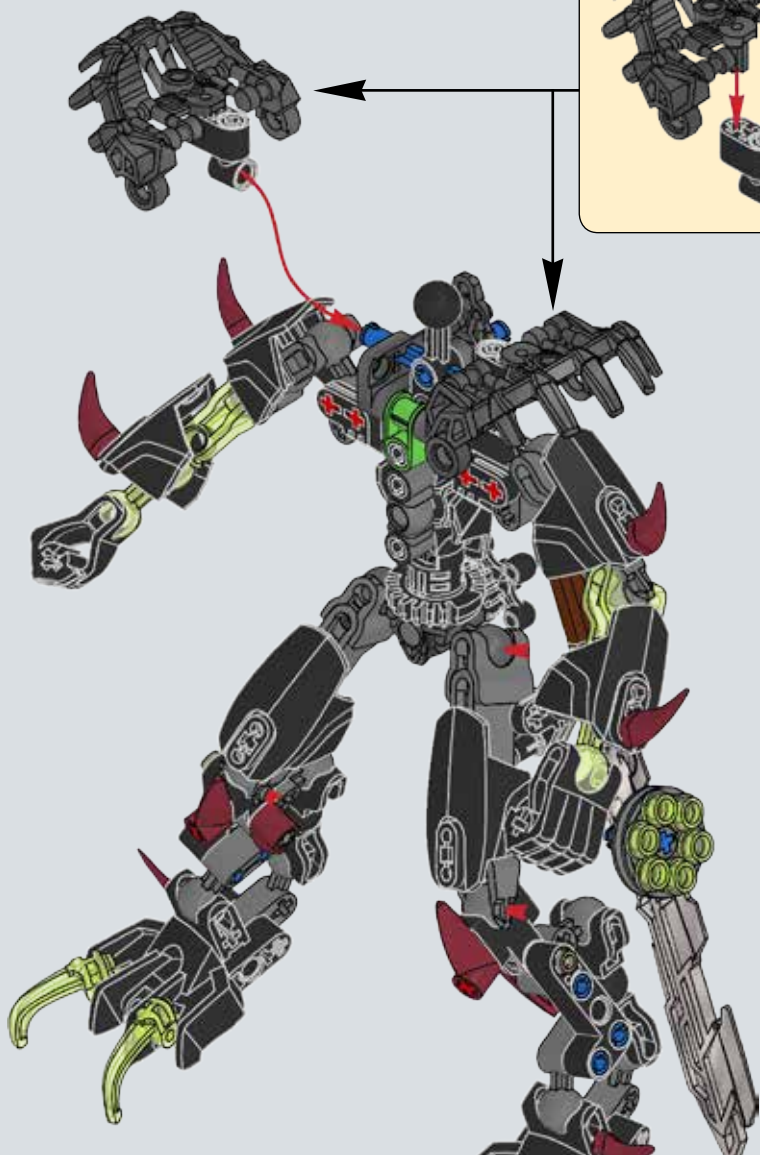
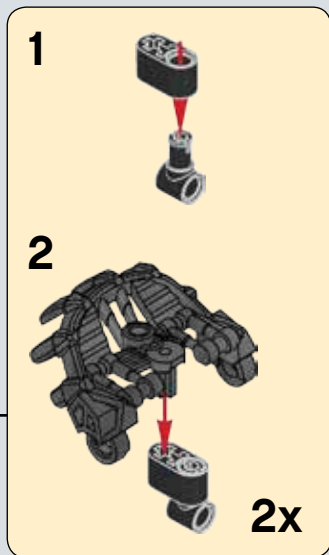



4x



1x

# 33

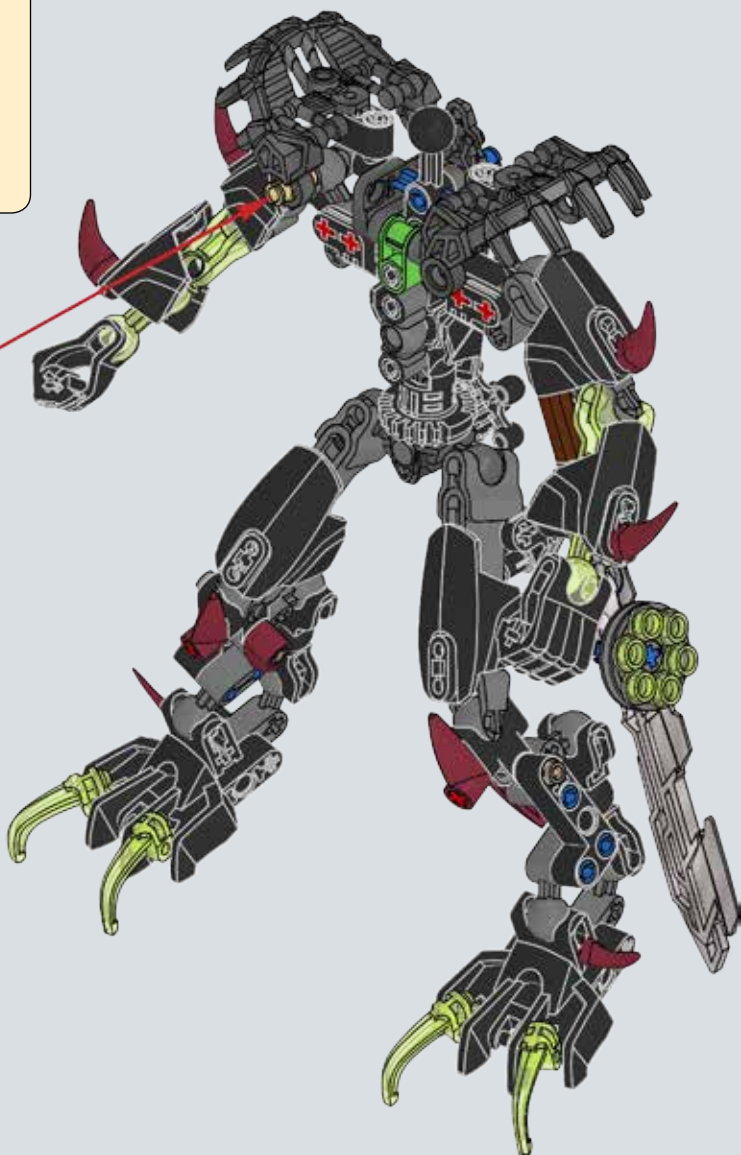
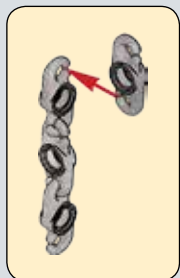

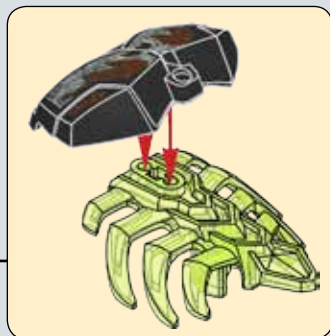
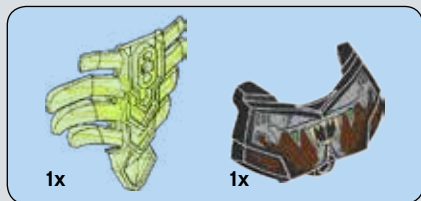

34





# 35

1



2

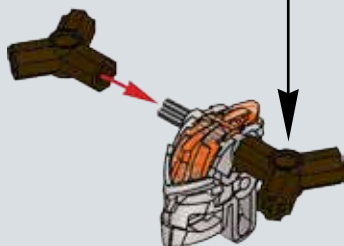
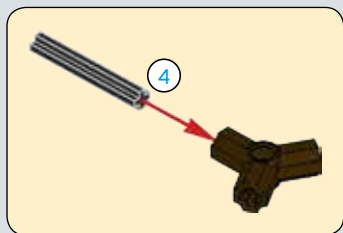

3

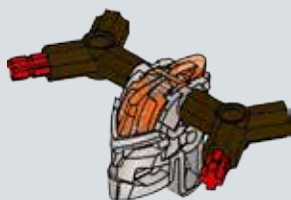

4

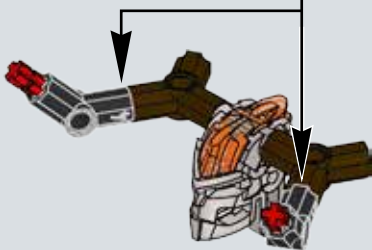
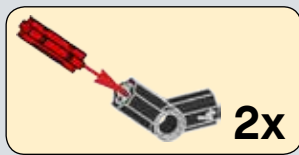

5

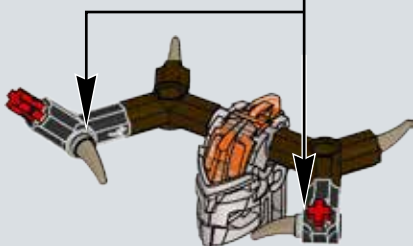
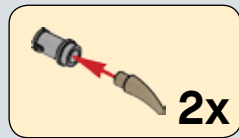

6

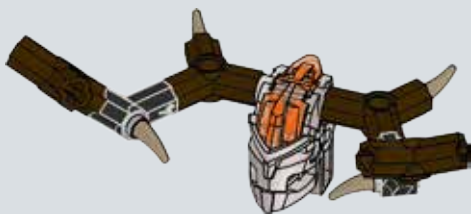

7

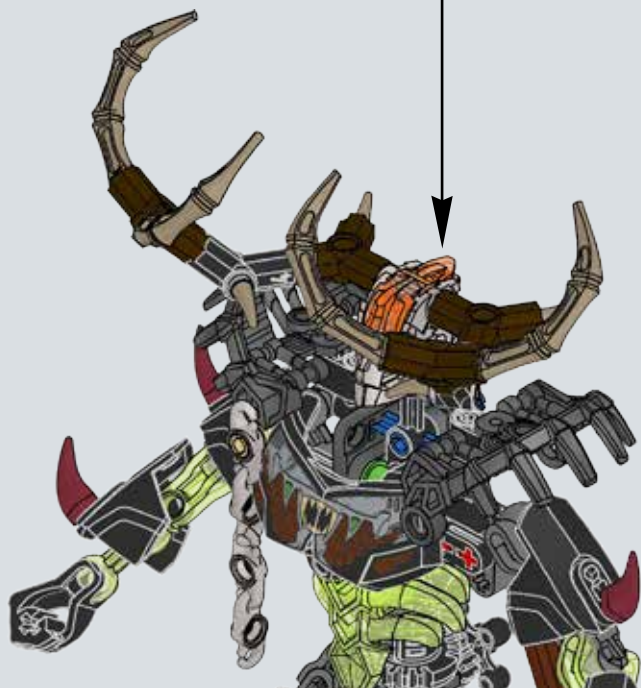
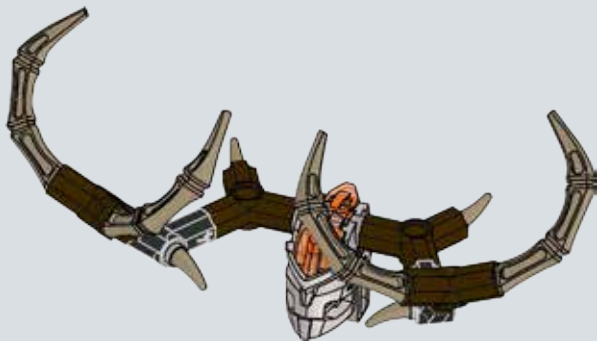

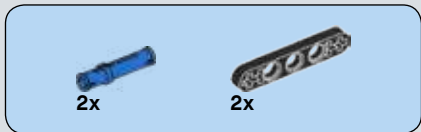

1

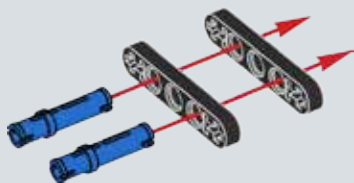

2

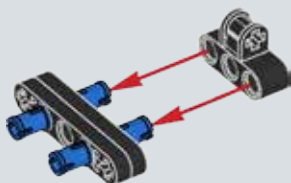

3

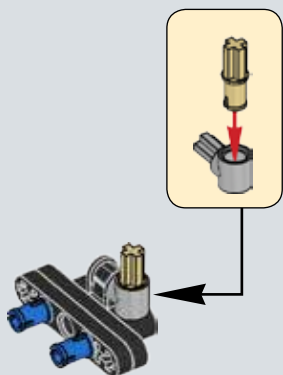

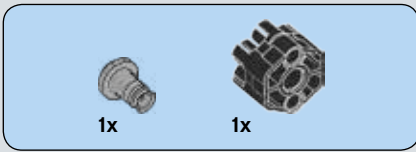

4

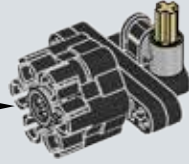
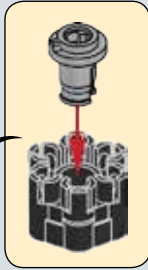

**CLICK**

**咔嗒**

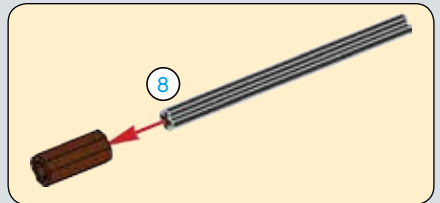
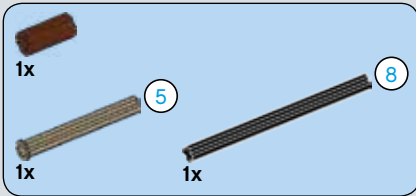

5

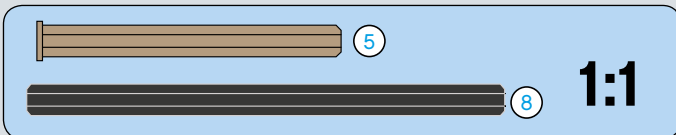
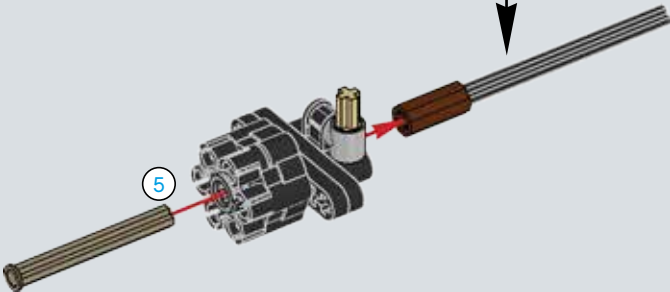



1x



1x

# 6

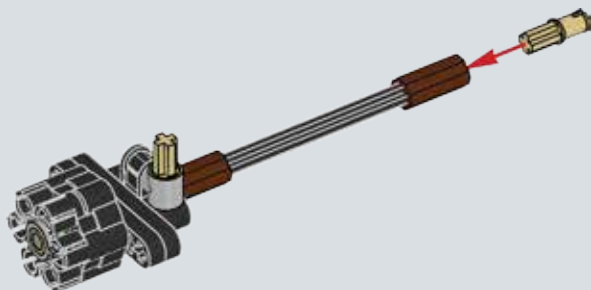

1x



1x

# 7





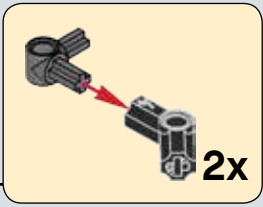
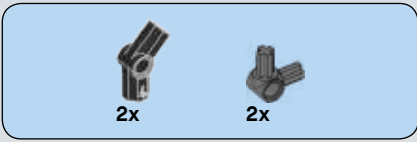

8

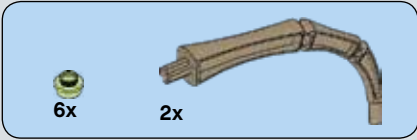
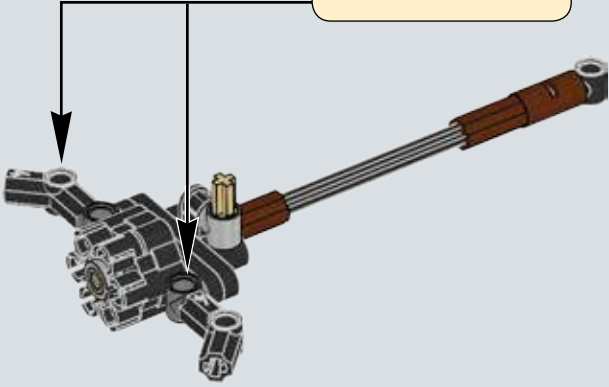

9

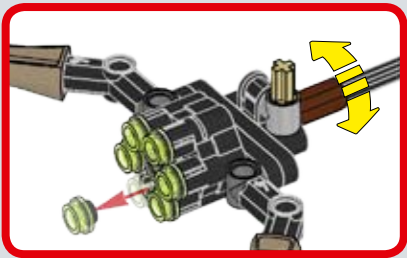
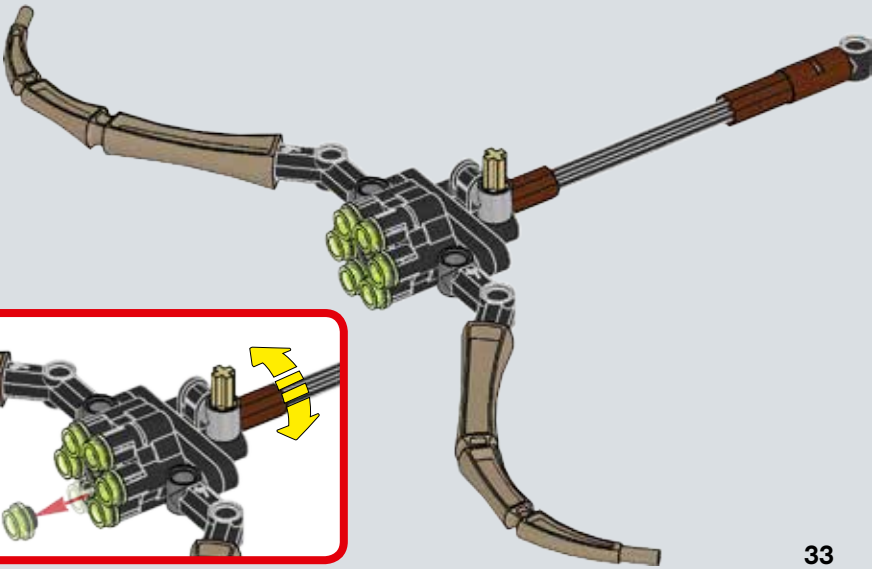



1x

# 36





# 37

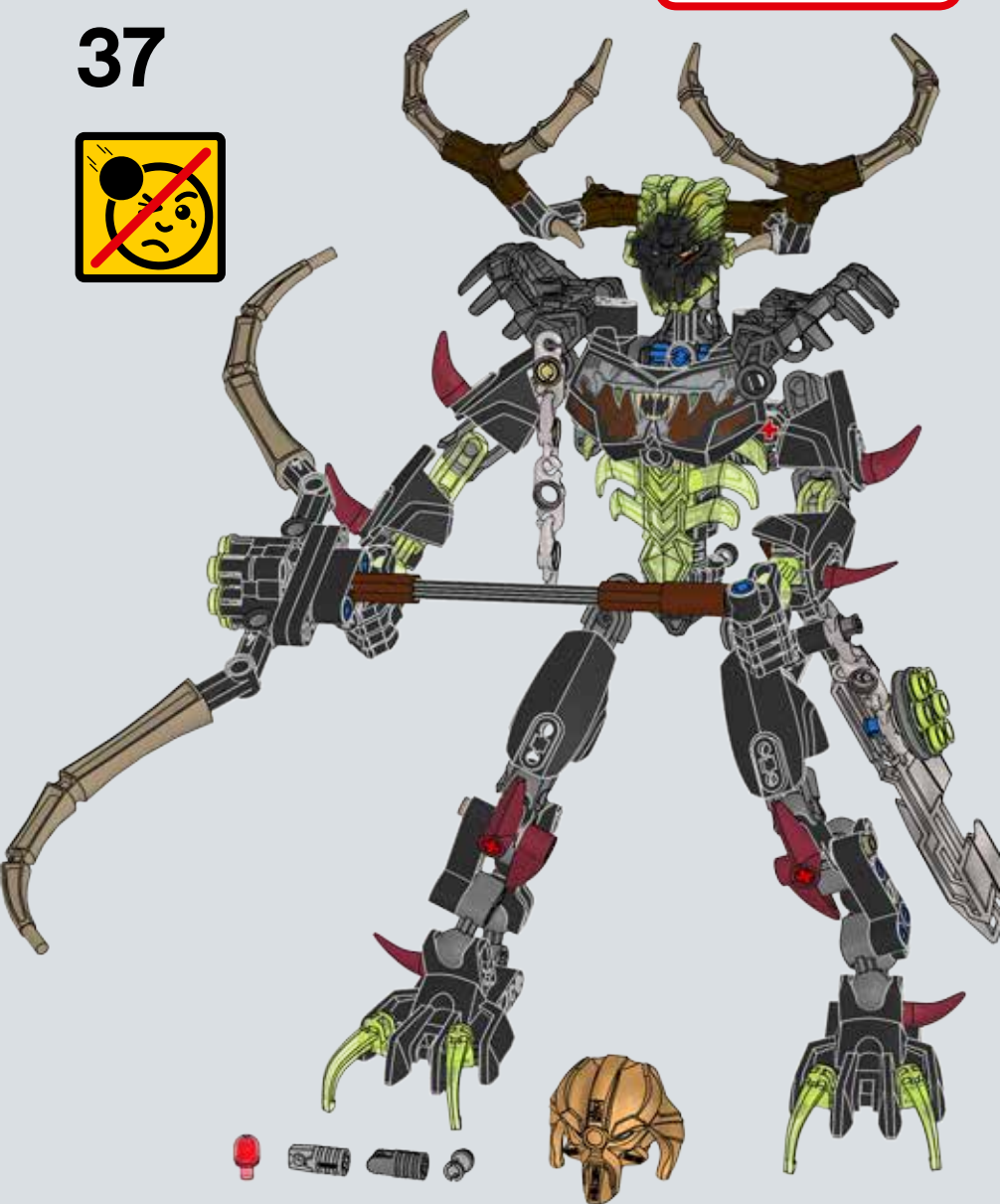

38





1

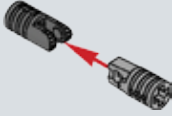

2

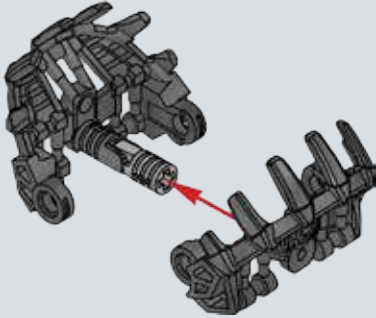

3

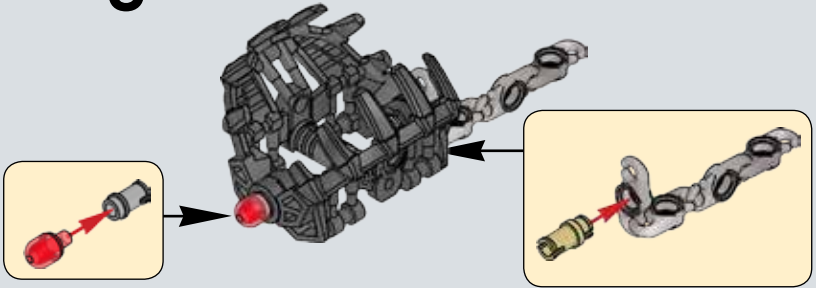

4

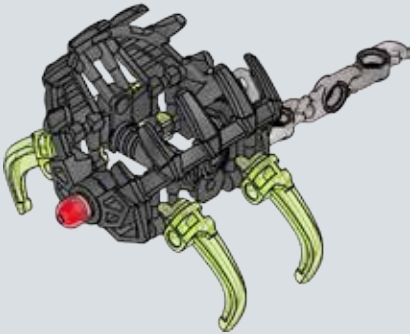

1x  
6013938

2x  
4666579

11x  
4142865

10x  
4206482

3x  
4514553

4x  
6073231

1x  
4107783

1x  
4177431

4x  
4121610

4x  
4121715

2x  
6006140

1x  
4248204

3x  
4610371

1x  
6007966

5x  
6044720

1x  
370526

2x  
4612482

2x  
4120017

2x  
4632637

2x  
6030286

1x  
6135125

2x  
4593567

2x  
6056379

1x  
6135166

2x  
4610948

1x  
6100104

1x  
6097399

1x  
4497943

1x  
6135215

4x  
6022717

2x  
6031821

4x  
6133123

1x  
6055631

4x  
6133131

6x  
6133143

3x  
4531751

1x  
6055781

1x  
4211573

3x  
4211483

1x  
4211679

1x  
6097090

1x  
6123815

3x  
4211815

12x  
6057034

1x  
4210695

2x  
6005331

2x  
6106472

1x  
4587275

2x  
6015356

8x  
4289258

1x  
6001085

2x  
6133126

1x  
370726

1x  
6083620

2x  
4622903

2x  
6121358

1x  
6135225

4x  
6005755

4x  
6133534

1x  
6135060

1x  
6114322

2x  
6133155

1x  
6114379

7x  
6124042

1x  
6102606

1x  
6138237

1x  
6139106

2x  
6135124



**Customer Service**

Kundenservice

Service Consommateurs

Servicio Al Consumidor

LEGO.com/service or dial



00800 5346 5555 :



1-800-422-5346 :



LEGO

BIONICLE



# UNITE for battle



71300+71310

VEREINT EUCH für die Schlacht  
UNIS-LES pour le combat  
Sólo podemos luchar UNIDOS  
UNE para combate  
ÉPÍTSD ÖSSZE ŐKET és  
harcolj az irányítás maszkjáért!  
ОБЪЕДИНИ СИЛЫ для борьбы  
POŁĄCZ SIŁY w walce  
团结奋战



[LEGO.com/bionicle](http://LEGO.com/bionicle)

Download App  
下载应用程序



NETFLIX



Download on the  
App Store

Apple, the Apple logo, iPad, iPhone and iPod touch are trademarks of Apple Inc.



Google Play is a trademark of Google Inc.





71311

71302

71301

71311

71307

71306



71303



71300



71304



71308



71305



71309



# WIN

GO TO [WWW.LEGO.COM/PRODUCTFEEDBACK](http://WWW.LEGO.COM/PRODUCTFEEDBACK)  
AND GIVE US YOUR SHORT **FEEDBACK**  
ABOUT THIS LEGO® SET FOR A CHANCE  
TO WIN A COOL LEGO PRIZE.

## LEGO.com/productfeedback

### GEWINNE



Erzähle uns auf  
[www.LEGO.com/productfeedback](http://www.LEGO.com/productfeedback)

etwas über die Erfahrungen, die  
du mit diesem LEGO® Set gemacht  
hast, und sichere dir die Chance  
auf einen coolen LEGO Preis!

### 获取奖品



登录  
[www.LEGO.com/productfeedback](http://www.LEGO.com/productfeedback)

给出关于此乐高®套装的简短反馈,  
就有机会获得炫酷乐高奖品

### GAGNE



Rends-toi sur  
[www.LEGO.com/productfeedback](http://www.LEGO.com/productfeedback)

et donne-nous quelques com-  
mentaires sur ce produit LEGO®  
pour avoir une chance de gagner  
un prix LEGO !

### 경품 당첨 기회



[www.LEGO.com/productfeedback](http://www.LEGO.com/productfeedback)

페이지로 이동하여 이 레고® 세트에  
대한 간단한 피드백을 보내 주시고  
멋진 레고 경품을 탈 수 있는 기회도  
잡으십시오

### GANA



Visita  
[www.LEGO.com/productfeedback](http://www.LEGO.com/productfeedback)

y envíanos tu opinión acerca de  
este set LEGO®. ¡Participarás en el  
sorteo de un premio LEGO!

### ЗАПОЛНИ АНКЕТУ И ПОЛУЧИ ПРИЗ



Перейди по ссылке  
[www.LEGO.com/productfeedback](http://www.LEGO.com/productfeedback)

ответь всего на несколько во-  
просов об этом наборе LEGO®,  
и у тебя появится шанс выиграть  
замечательный приз от компании  
LEGO.