



# Friends



# 3315



**WARNING: CHOKING HAZARD.**  
Toy contains small parts and a small ball.  
Not for children under 3 years.

1

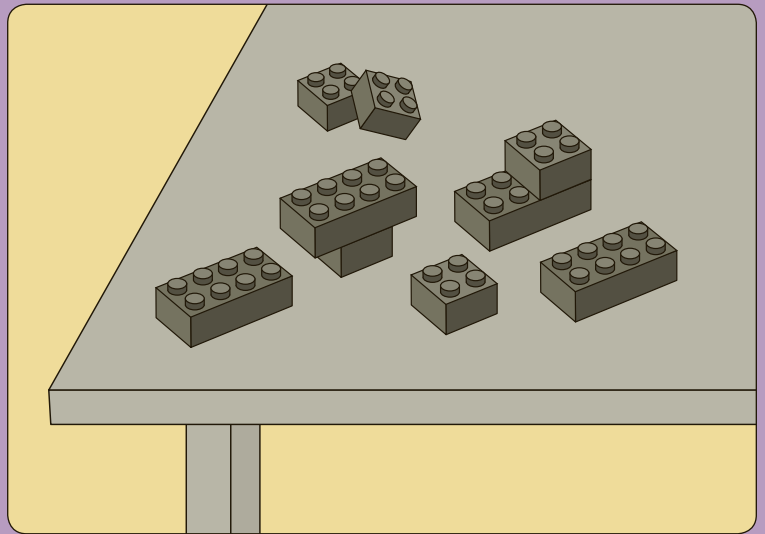
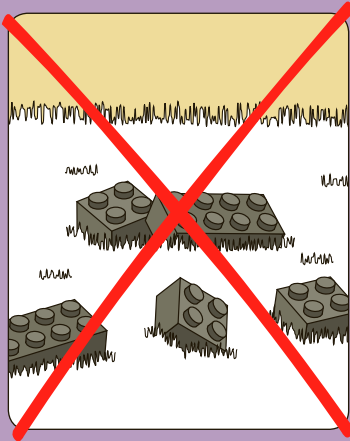

2





+

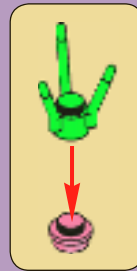
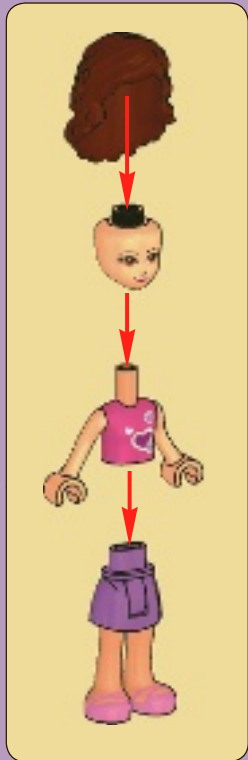

**AVERTISSEMENT : RISQUE D'ÉTOUFFEMENT.**  
Le jouet contient des petites pièces ainsi qu'une petite boule.  
Il ne convient pas aux enfants de moins de 3 ans.



**ADVERTENCIA: PELIGRO DE ASFIXIA.**  
Juguete que contiene partes pequeñas y una pelota pequeña.  
No recomendado para niños menores de 3 años.



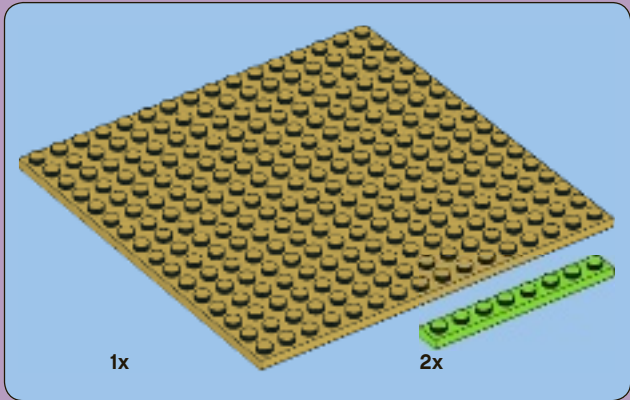

1

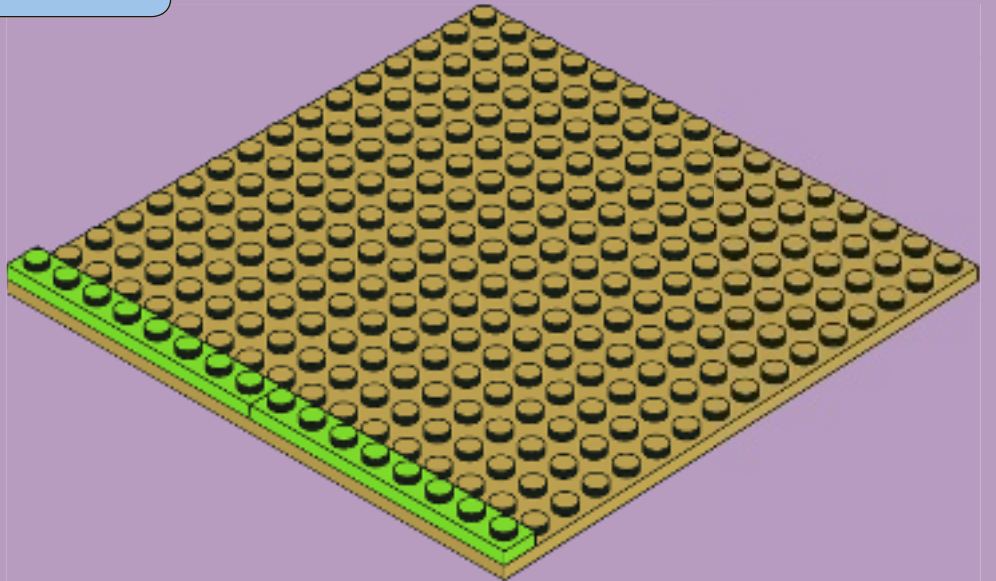



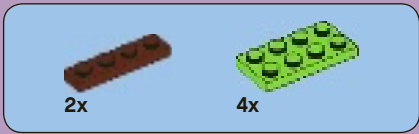

2

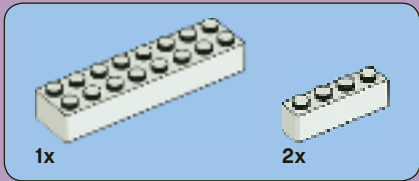
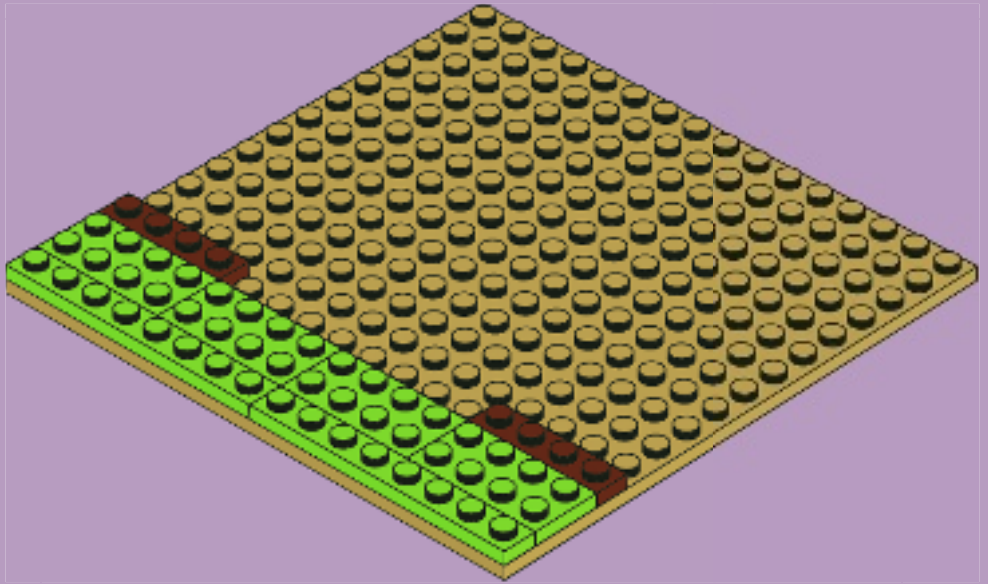

3





2x



4x



2x

4

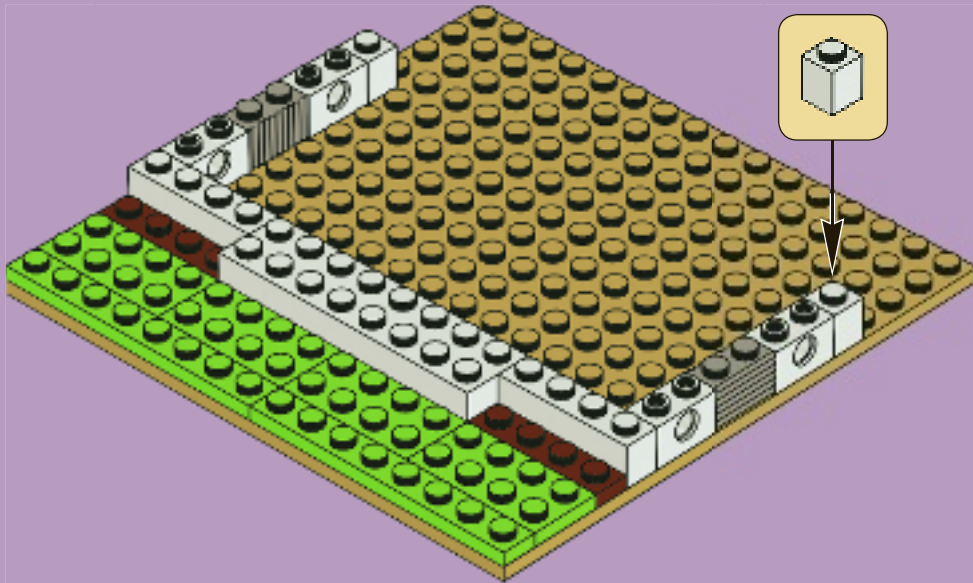

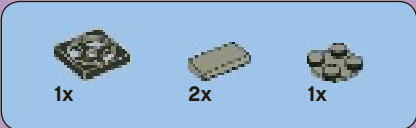

5

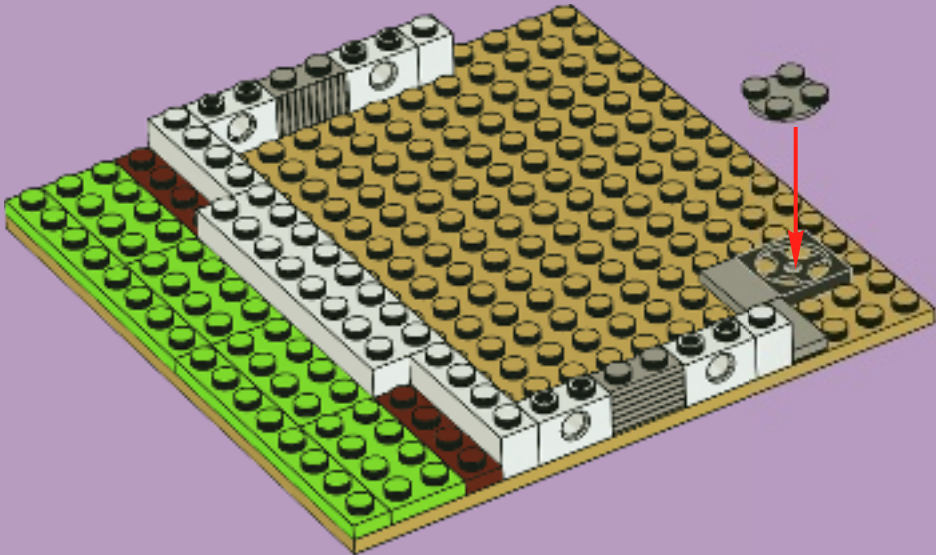



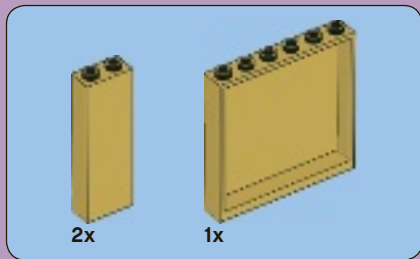

6

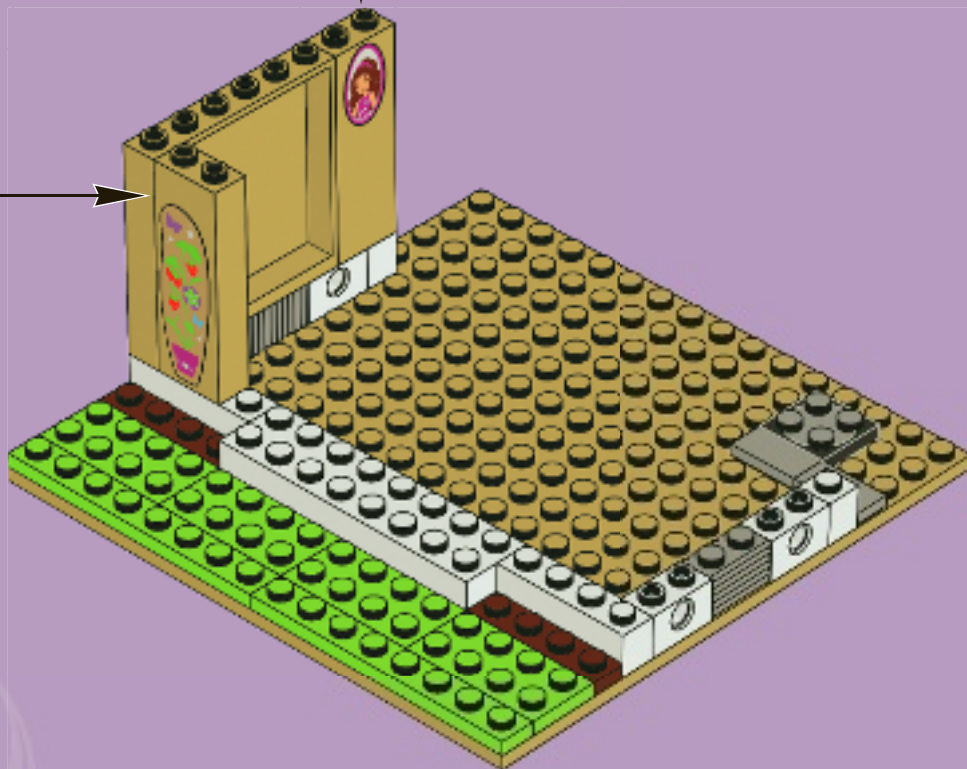
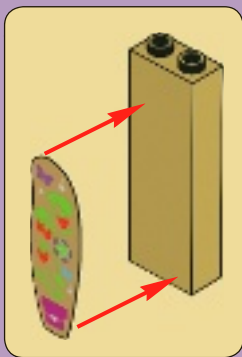

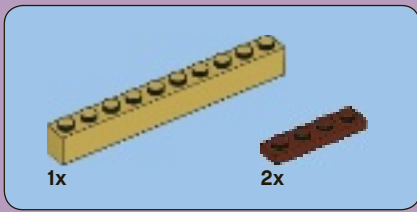

7





4x



2x

8

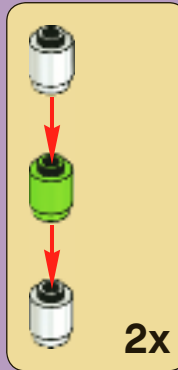



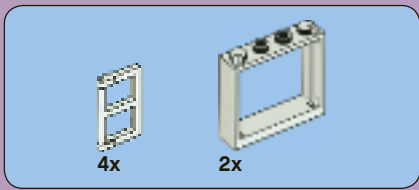

9

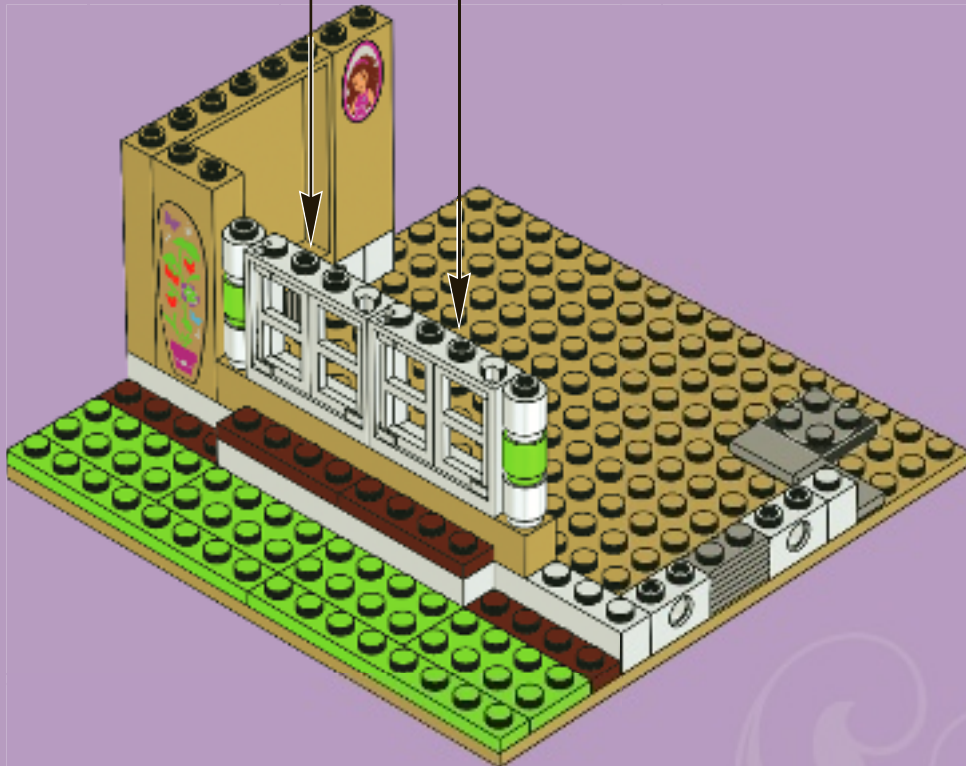
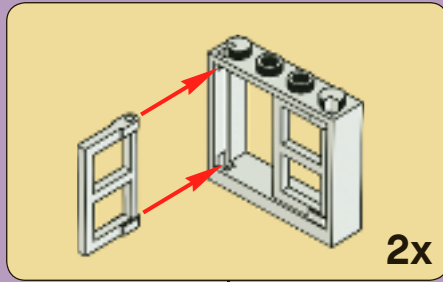



2x

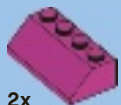

2x

# 10



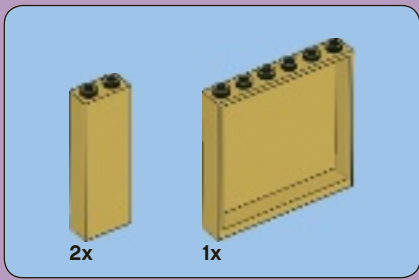

11

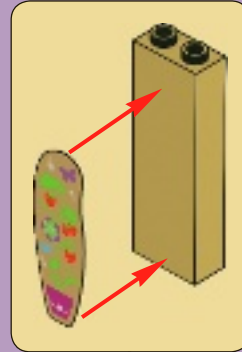



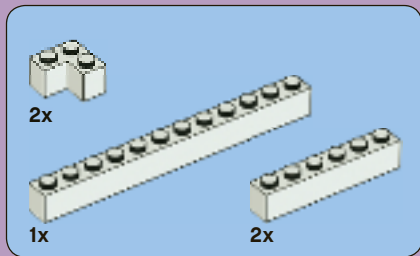

12

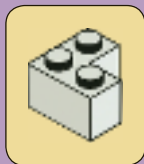



# 13





5x



2x



3x

# 14

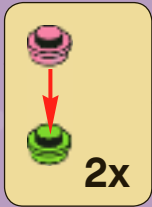



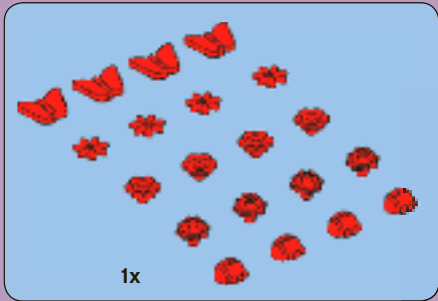
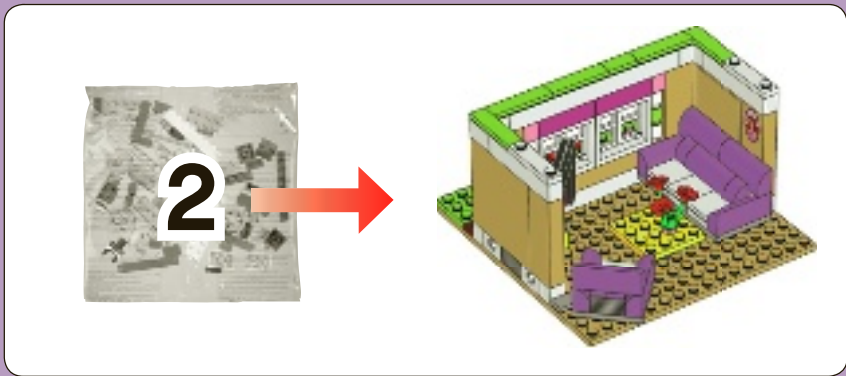

15



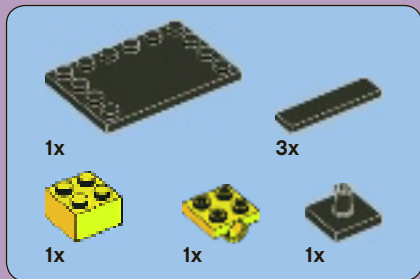

# 16

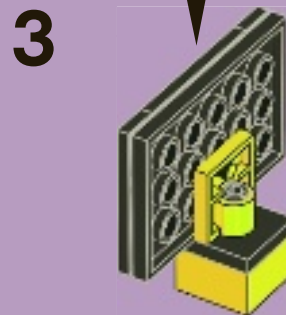
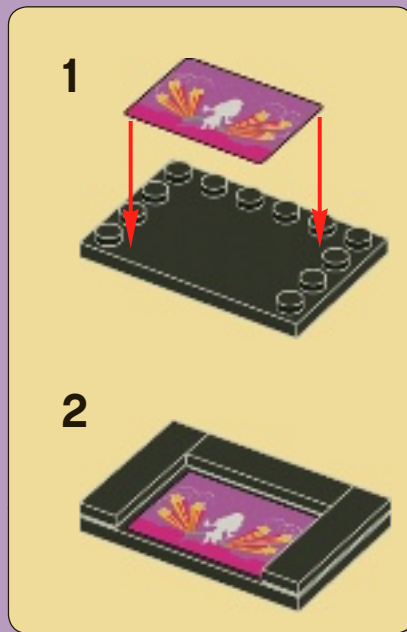

4

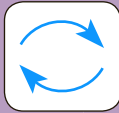

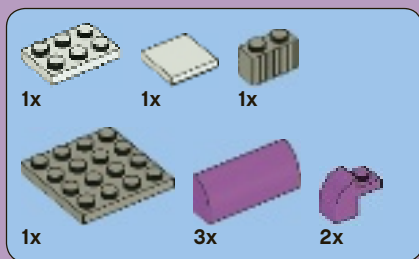

# 17

1



2



3



4



5

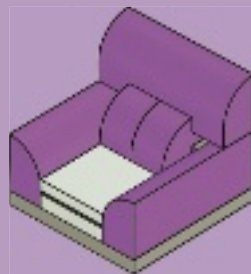





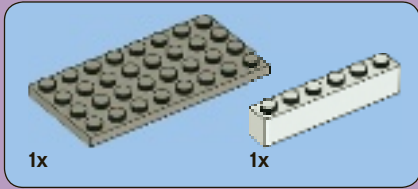
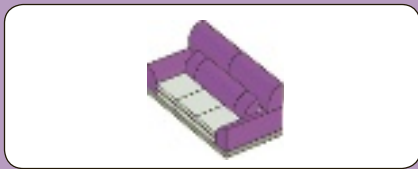

1

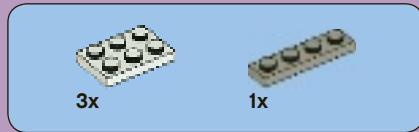
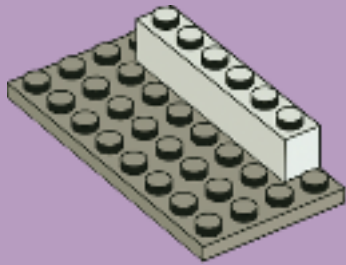

2

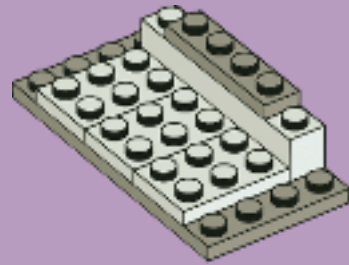



2x

3

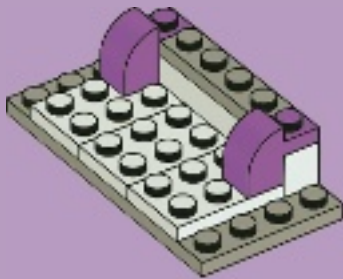

3x



3x

4

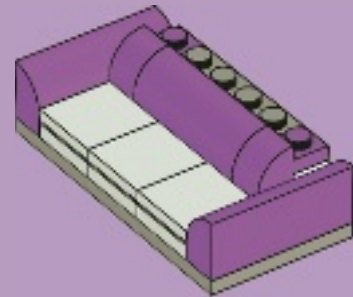

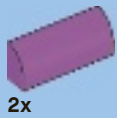

2x

5

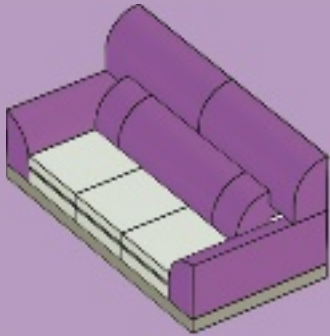

2x

6

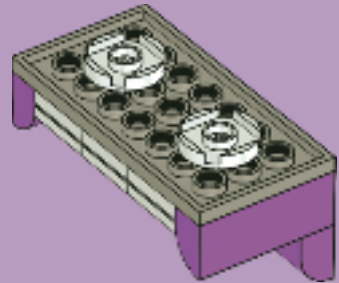
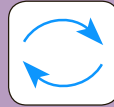

18



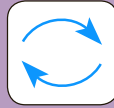

# 19

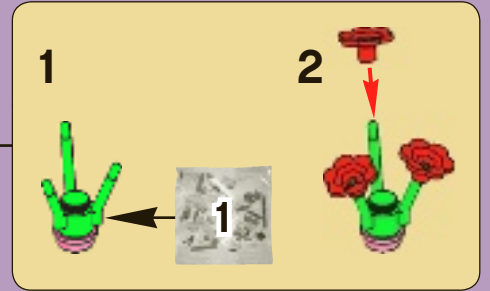
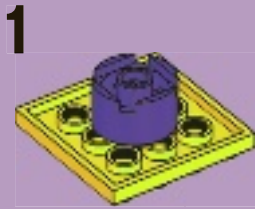

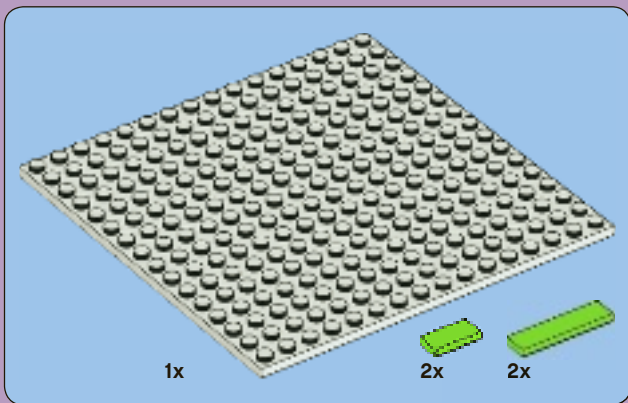
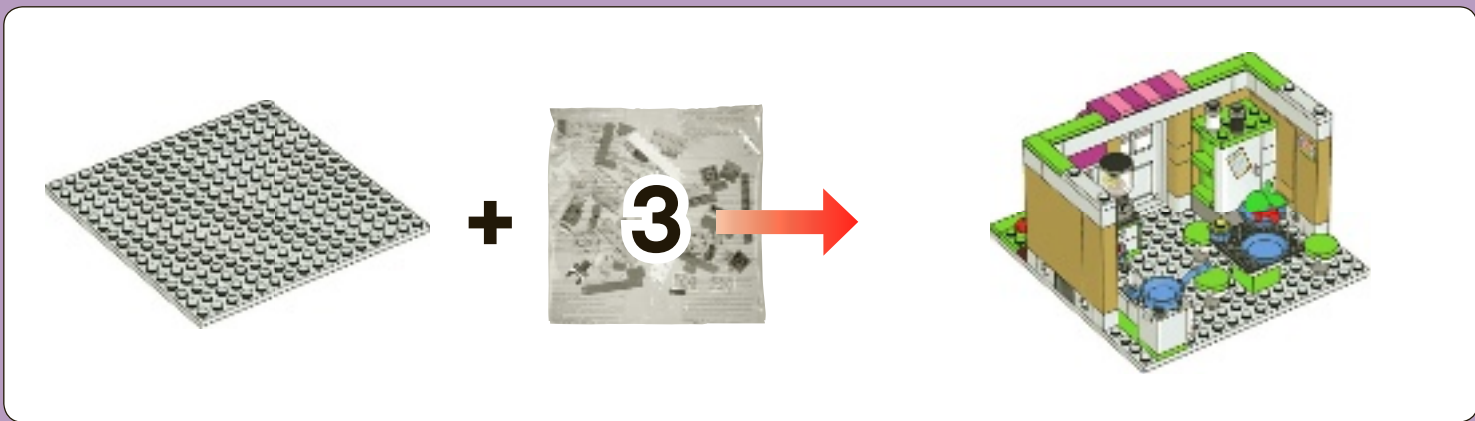

**1**

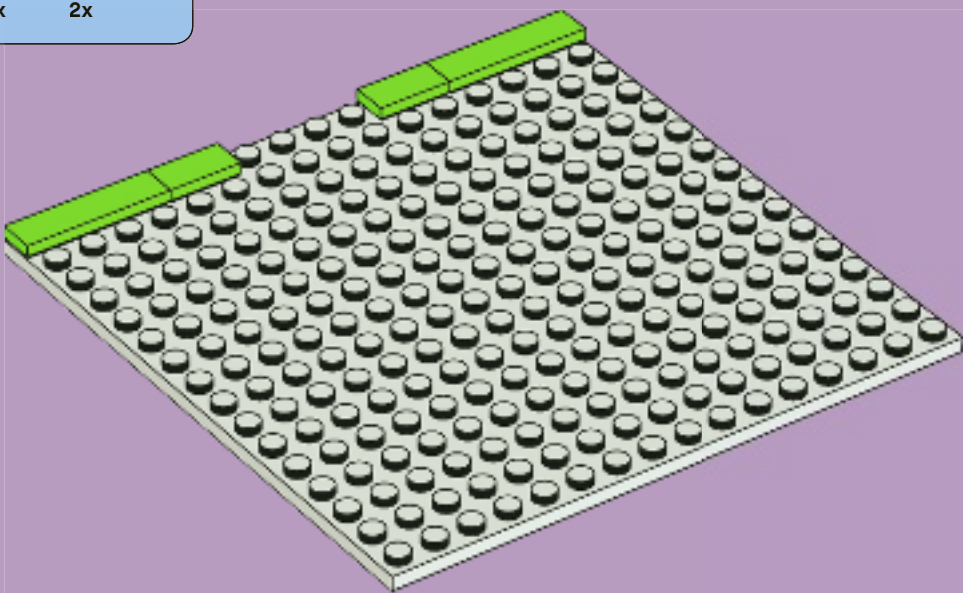



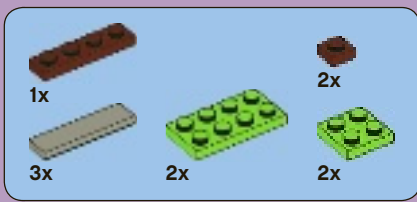

2

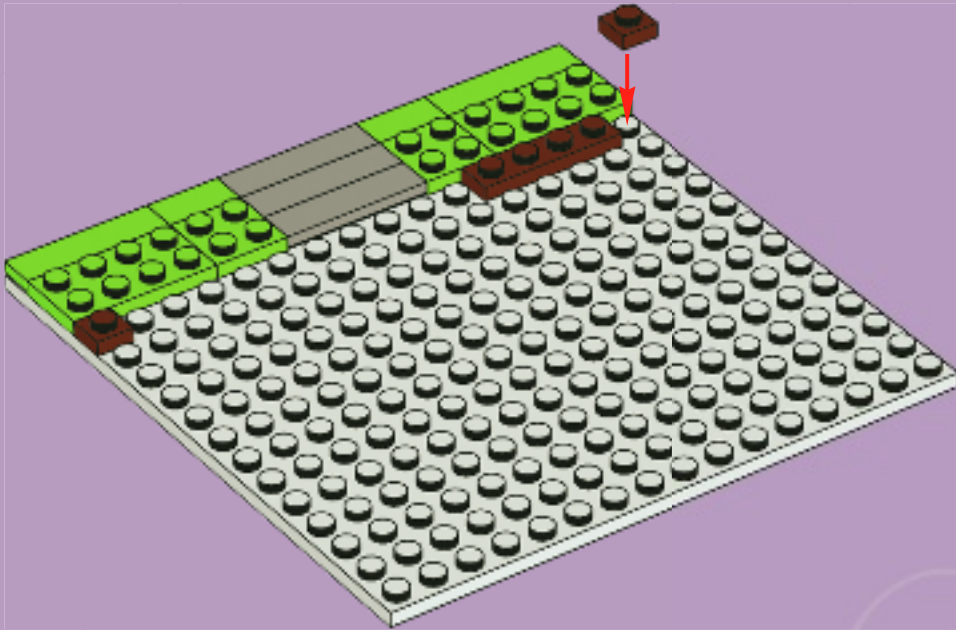



3

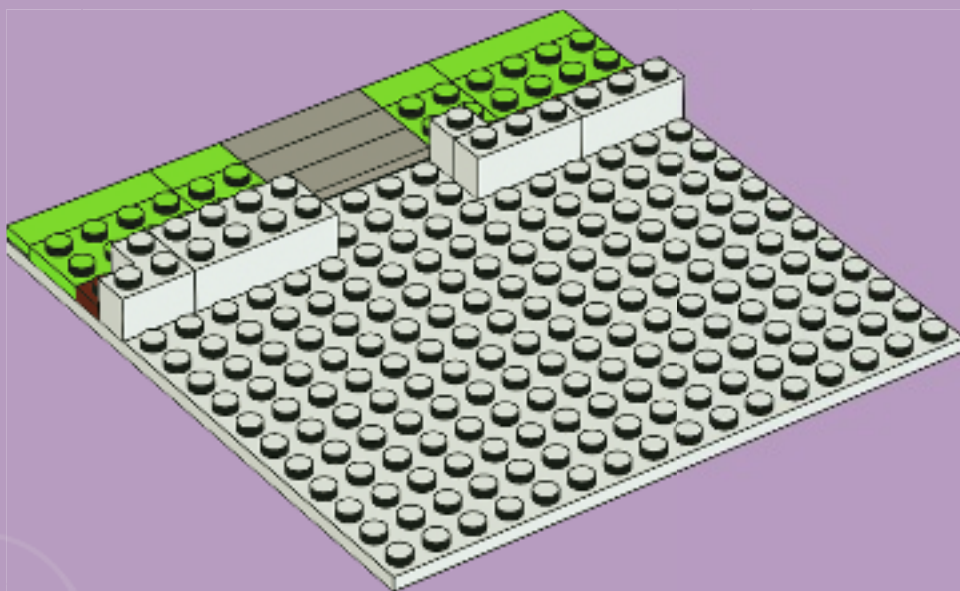



2x



4x



2x

4

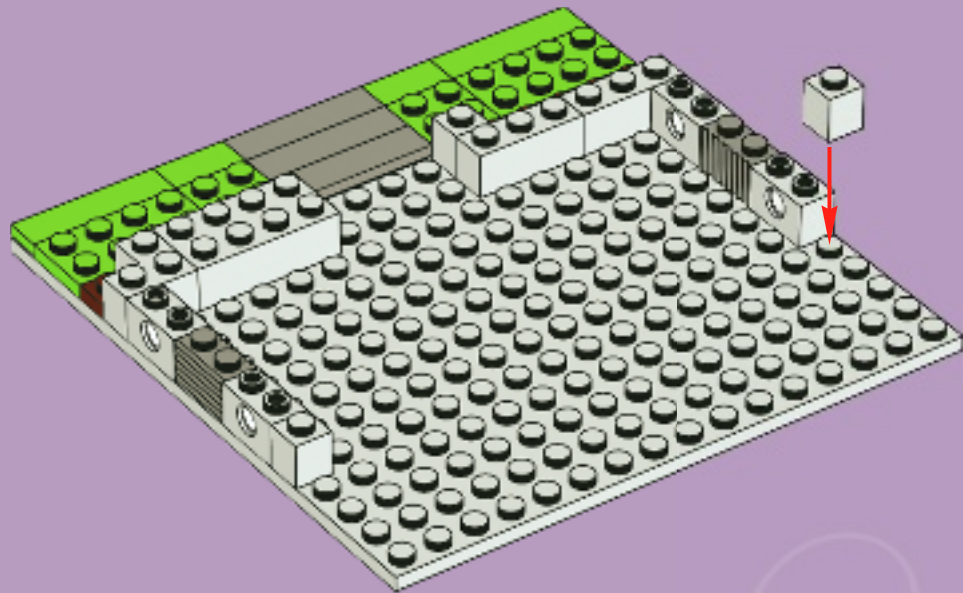

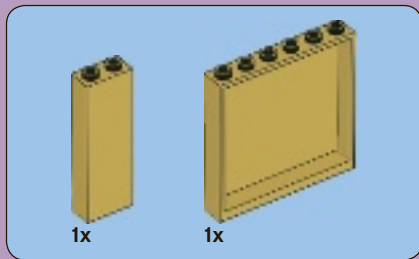

5

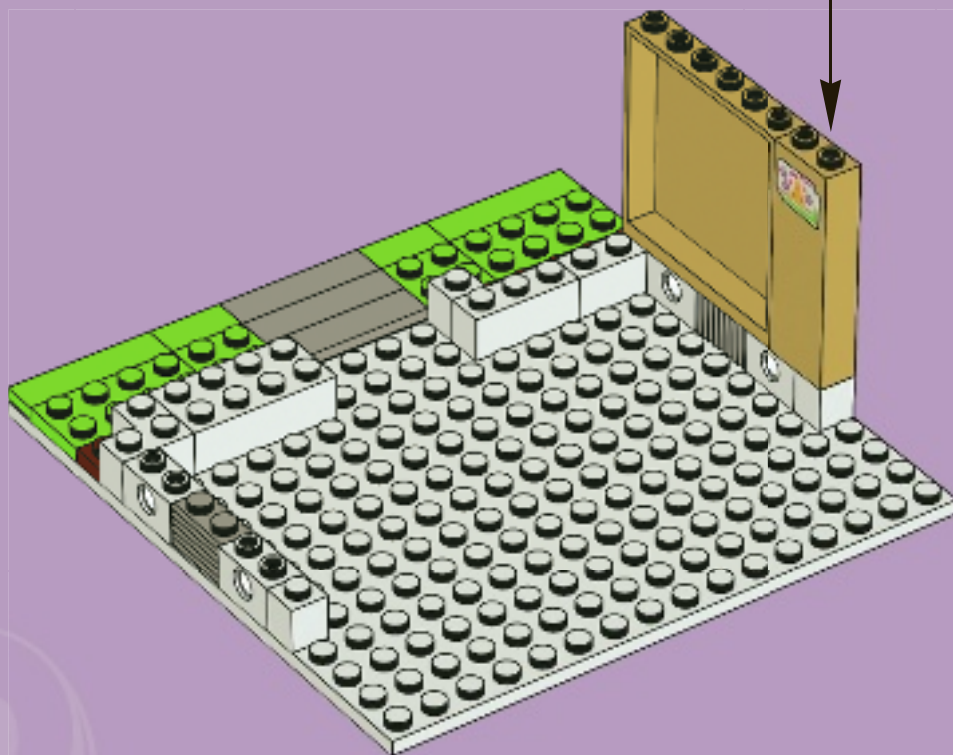
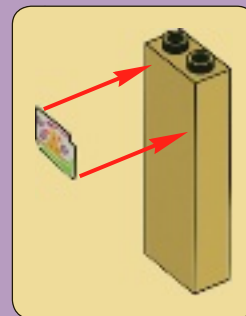

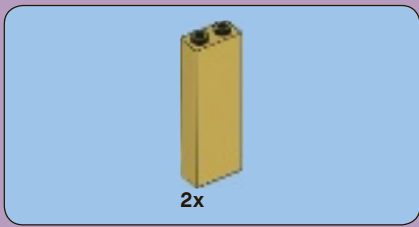

6

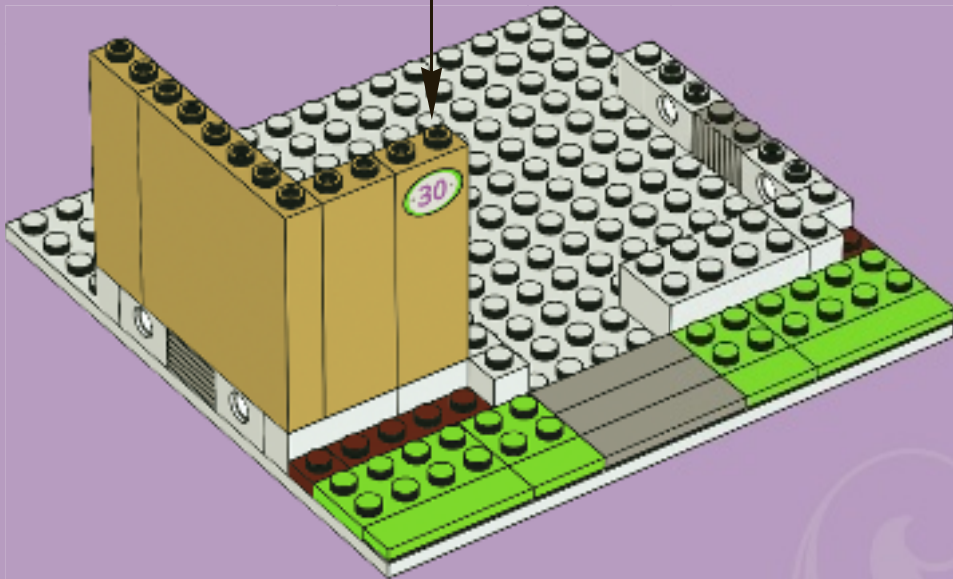



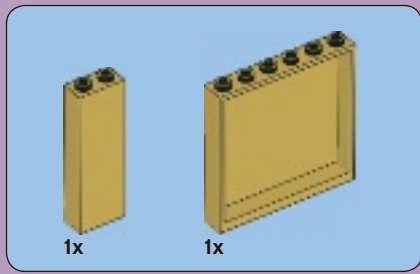

7

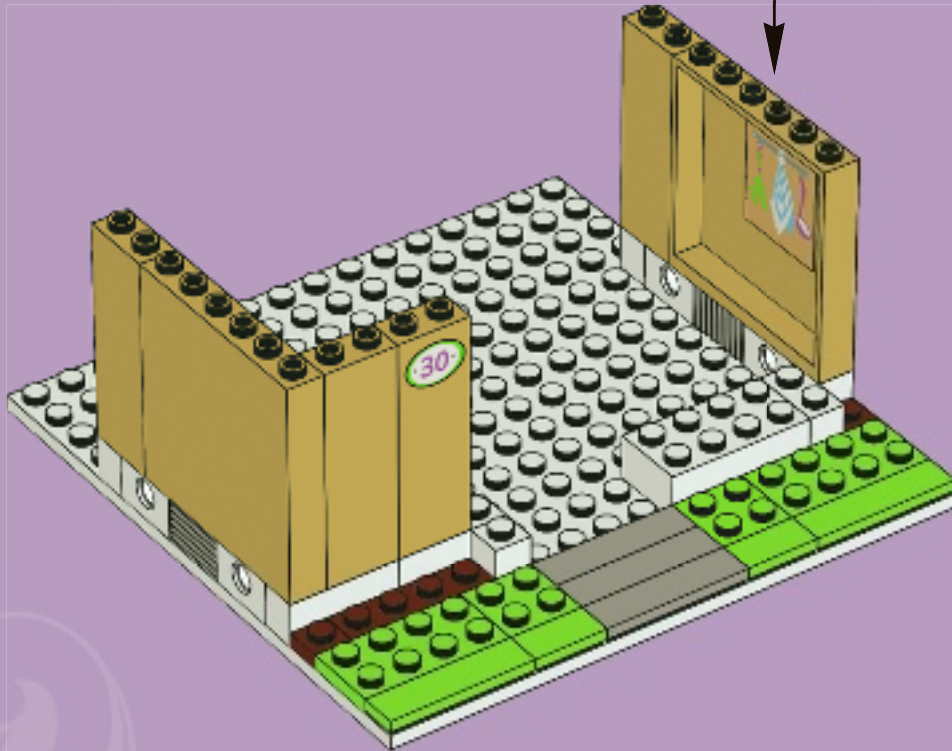
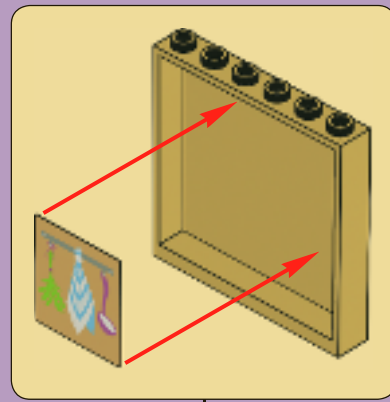

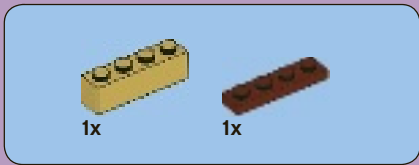

8

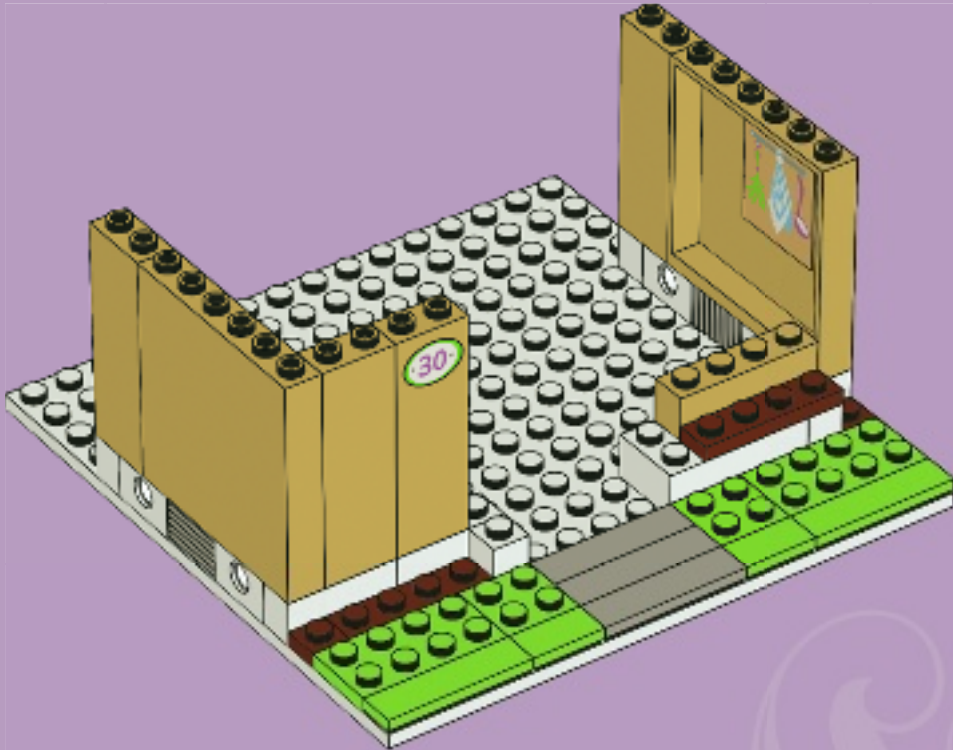

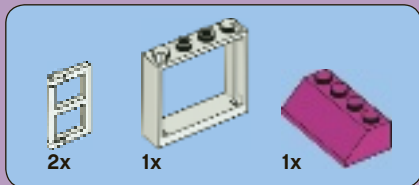

9

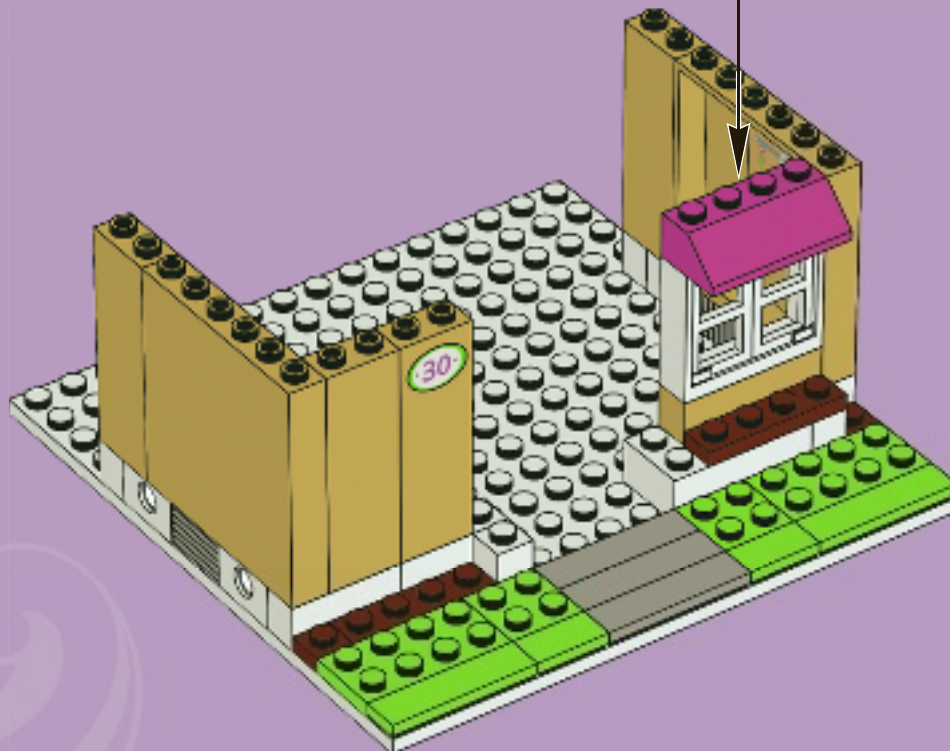
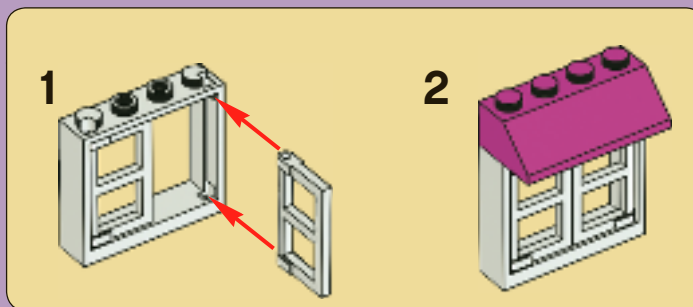



# 10

1



2



3



4



2x

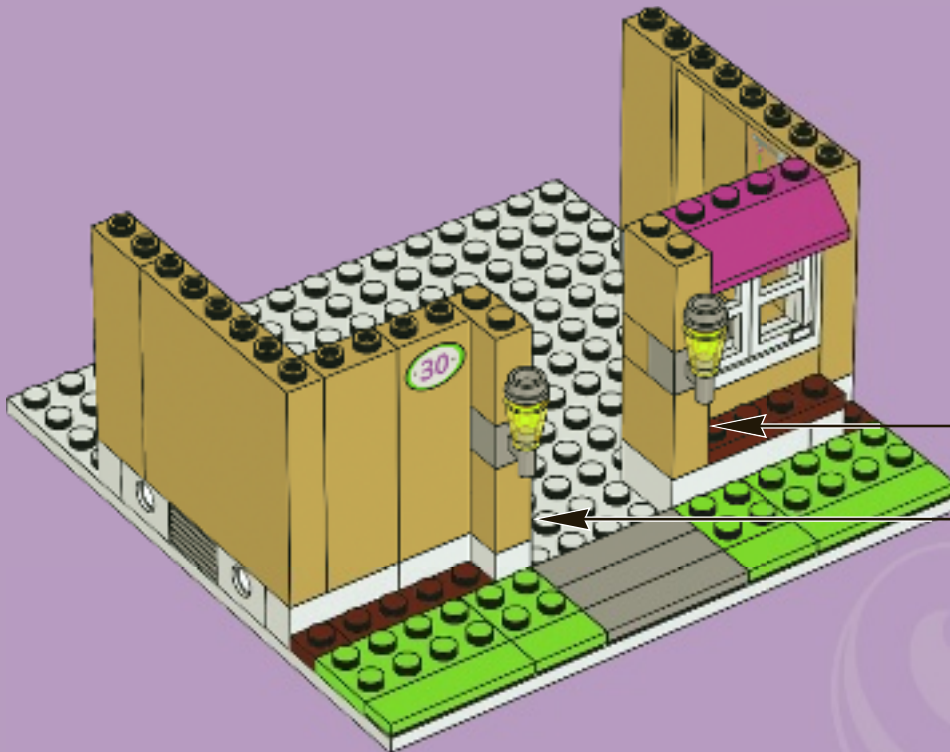

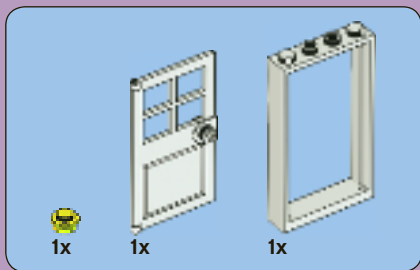

11

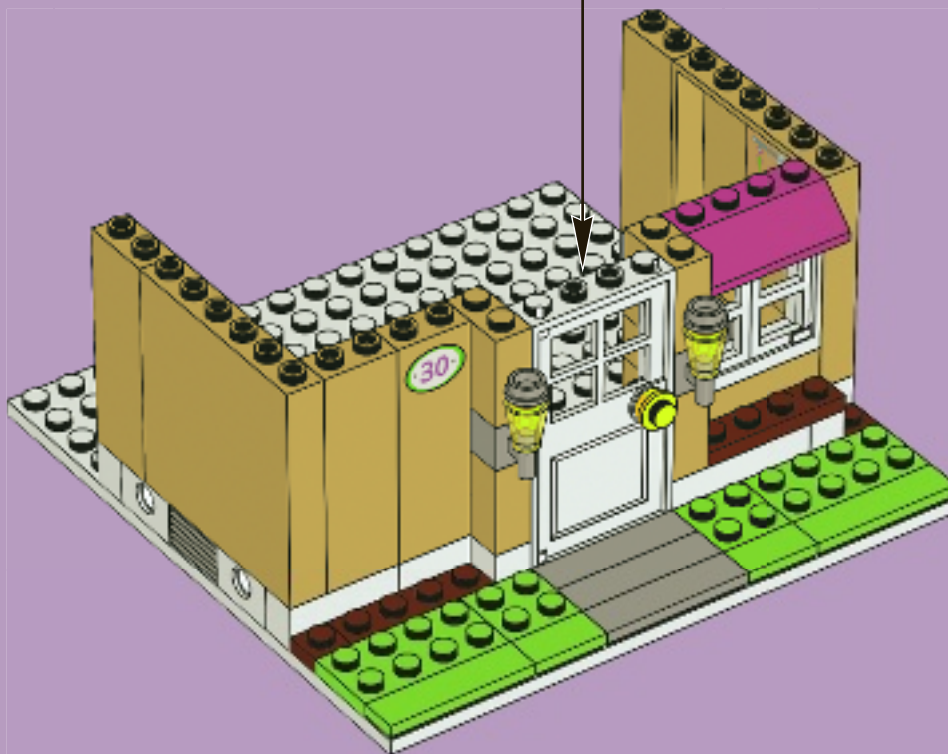
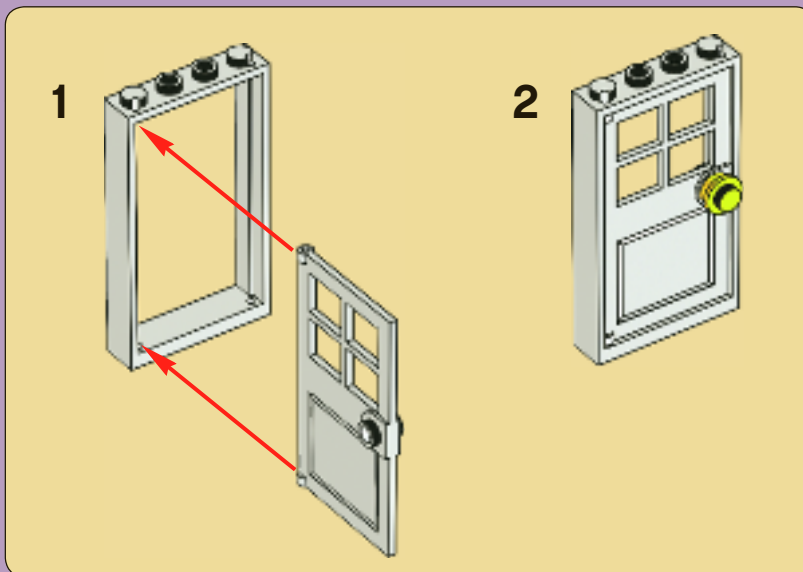



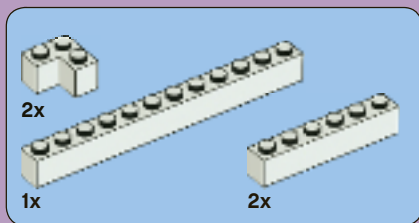

# 12

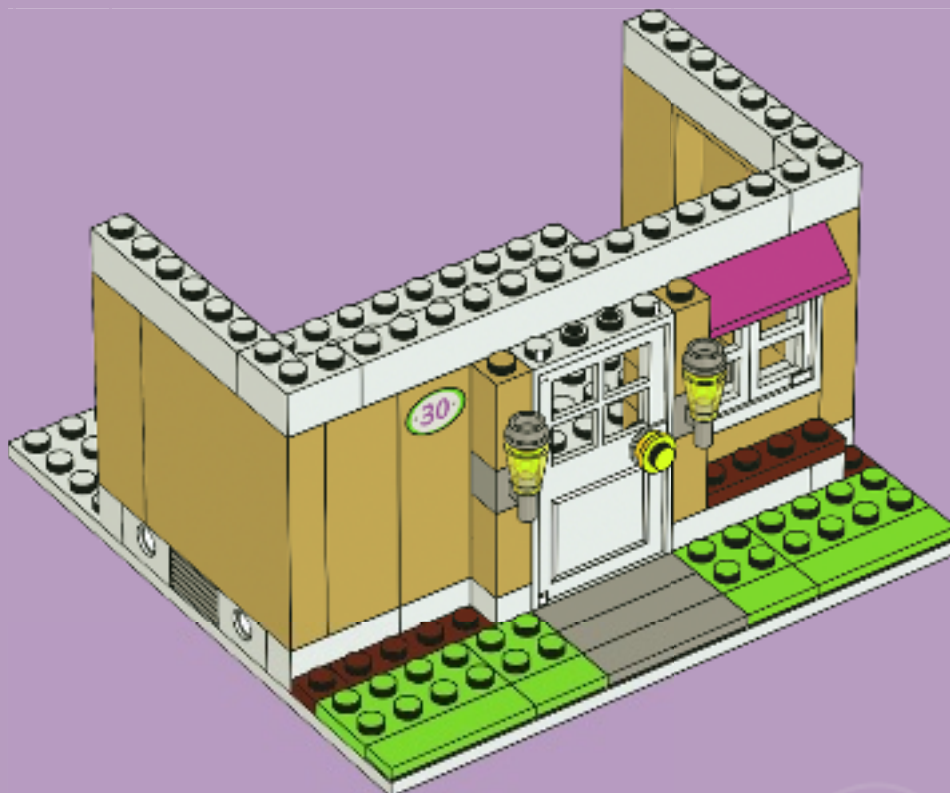



3x



3x

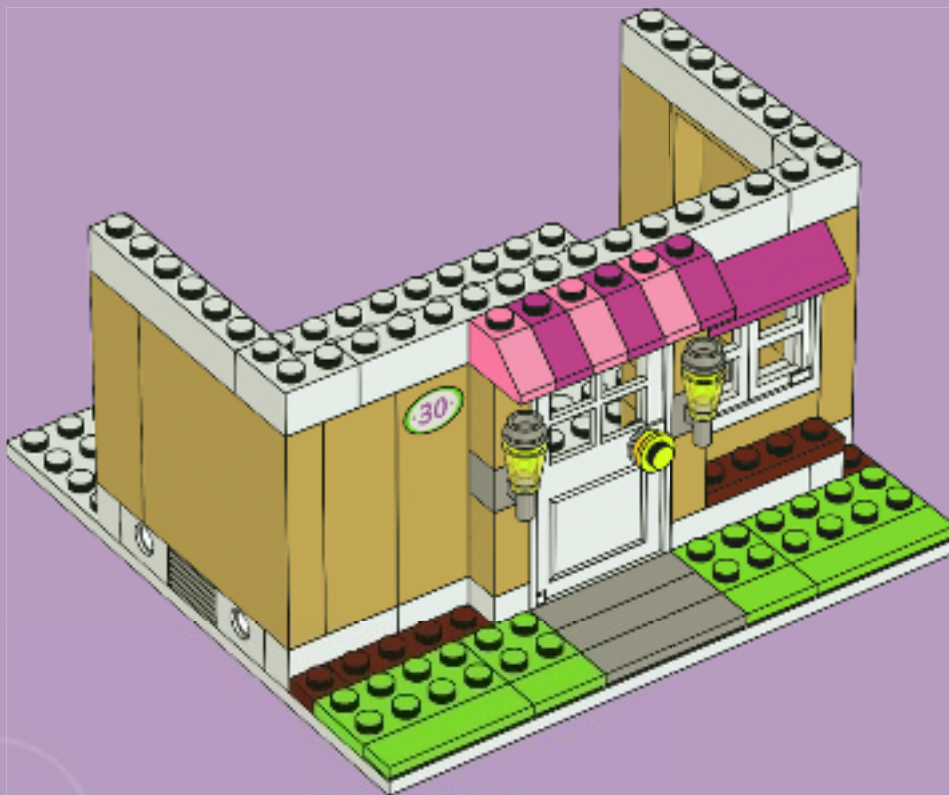

# 13





# 14



2x  2x  1x 

# 15

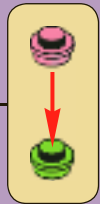
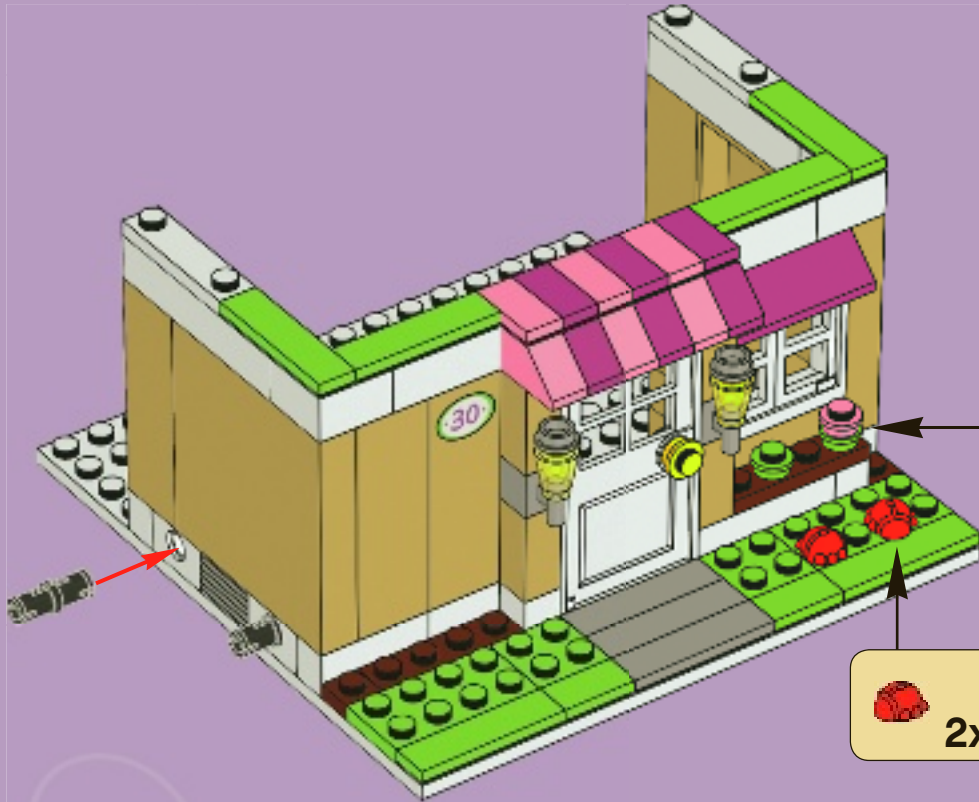



16

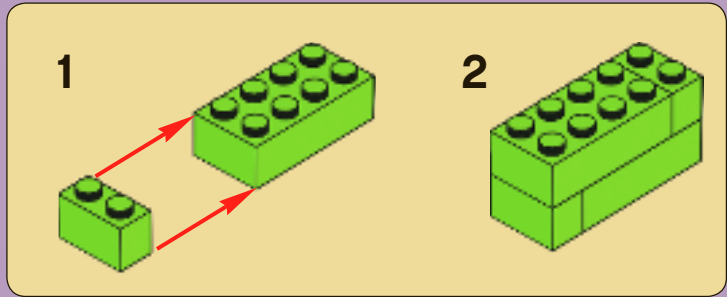

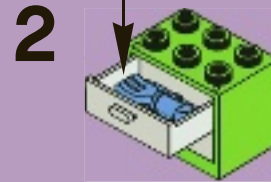
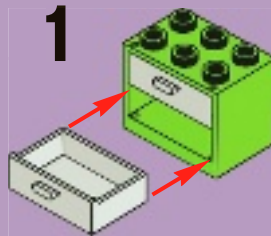
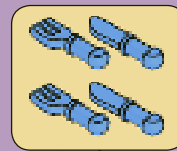
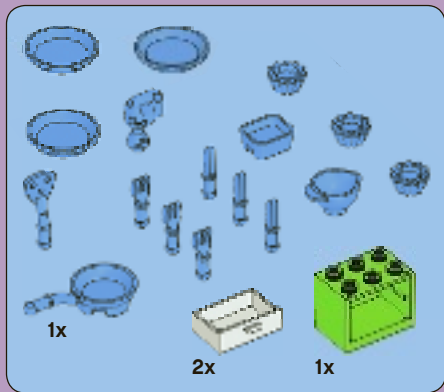

17







18

1

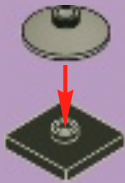

2



3



4



5





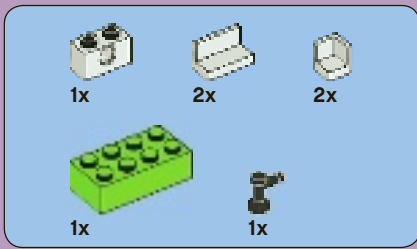

19

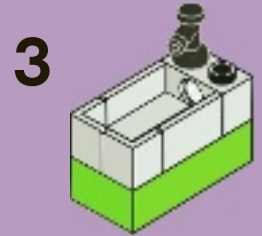
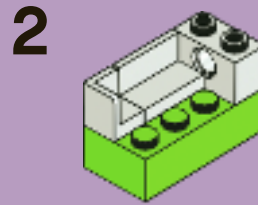
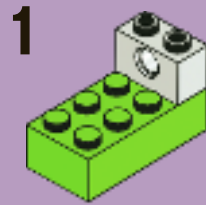

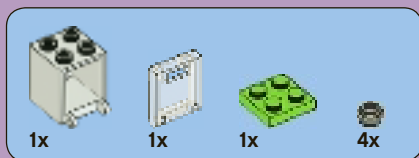

20

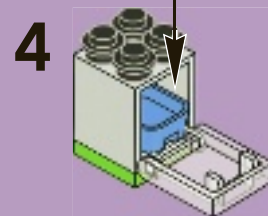
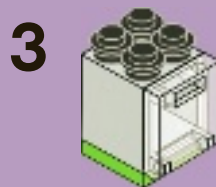
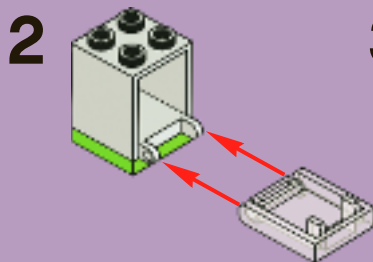
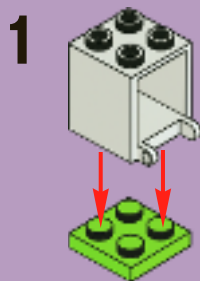



1x

# 21

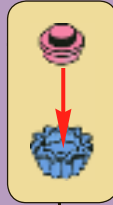



1

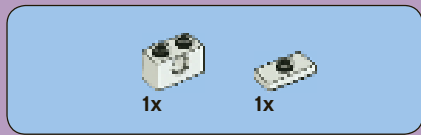
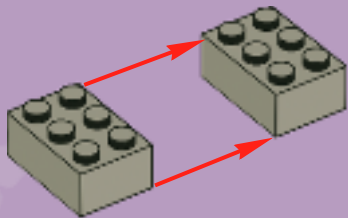

2

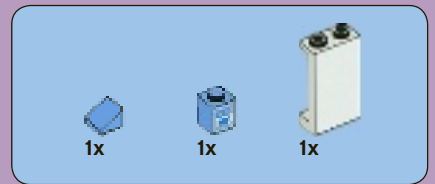
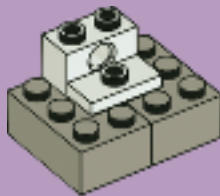

3

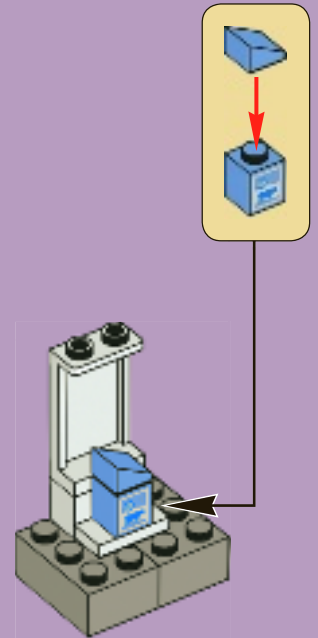





4x

4

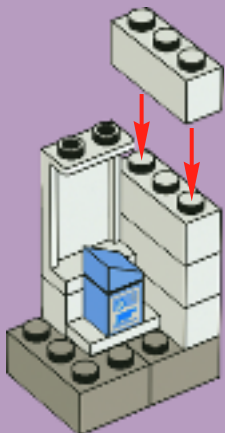

2x

5

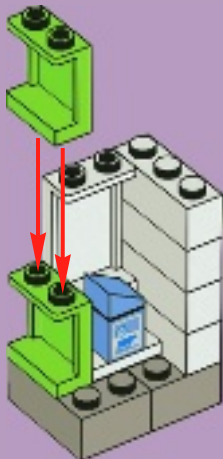

1x



1x

6

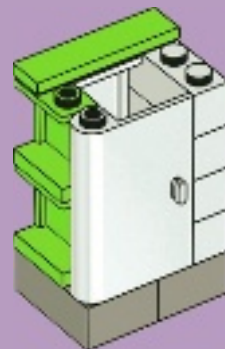



1x

7

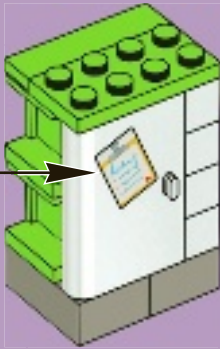
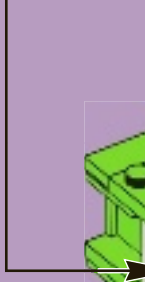

2x



1x



1x

8

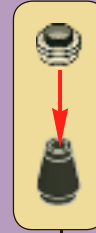
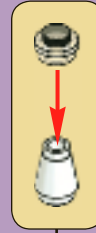

22





23

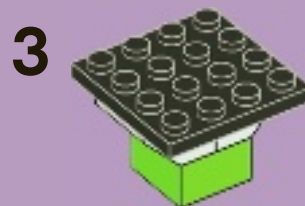
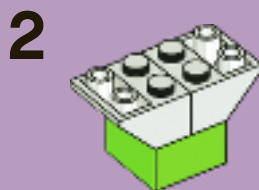
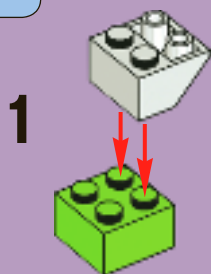



3x



3x



3x

# 24

1

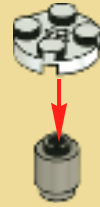

2



3x



1x  1x  1x 

# 25

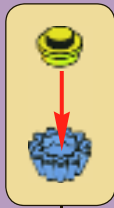



# 26

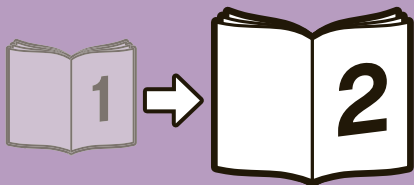
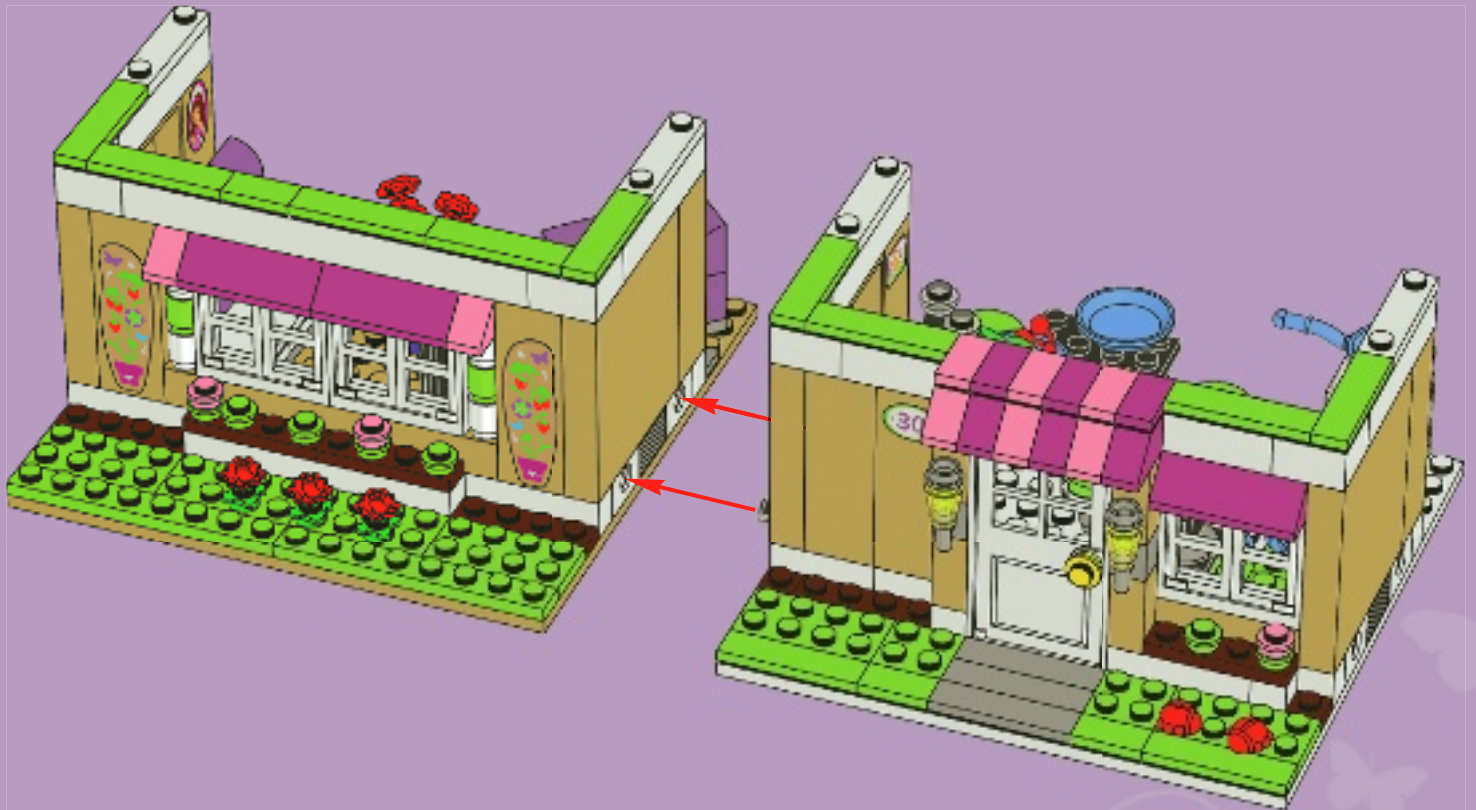
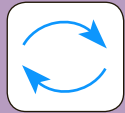

**LEGO** Friends



[www.LEGO.com](http://www.LEGO.com)

LEGO and the LEGO logo are trademarks of the/son des marques de commerce de/son marcas registradas de LEGO Group. ©2012 The LEGO Group. 6001960

[LEGOFriends.com](http://LEGOFriends.com)







# Friends



3315

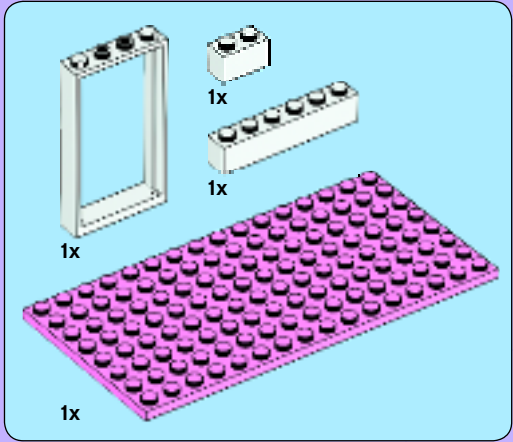
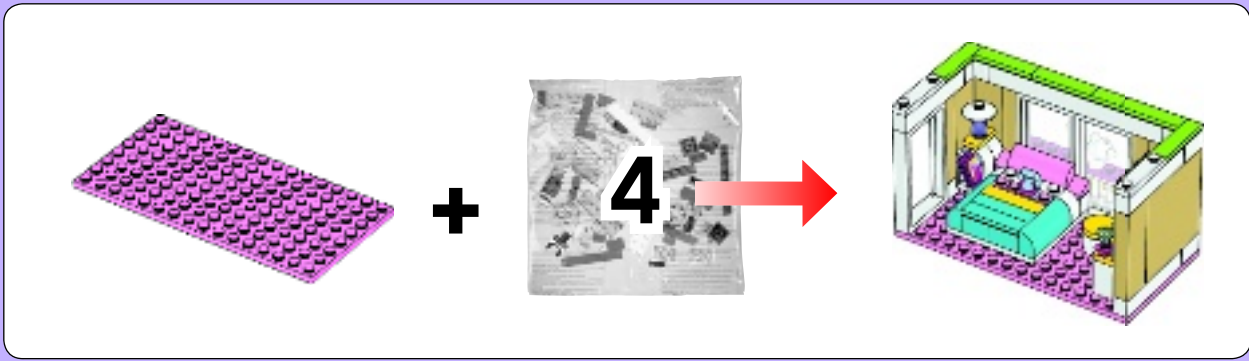

1

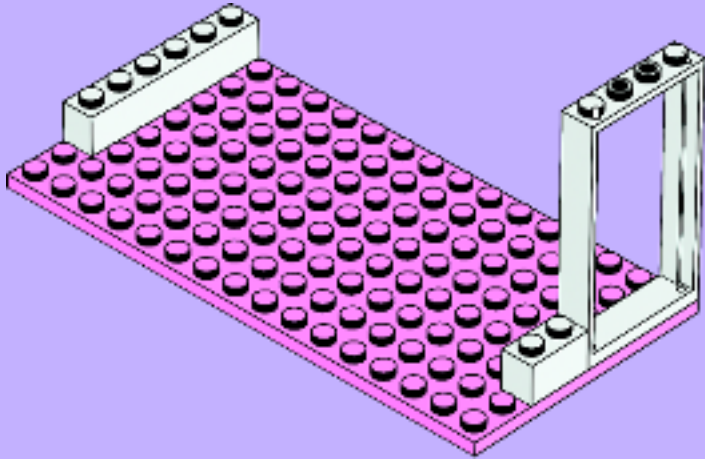



2x



2x

# 2

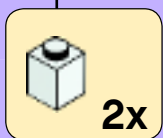
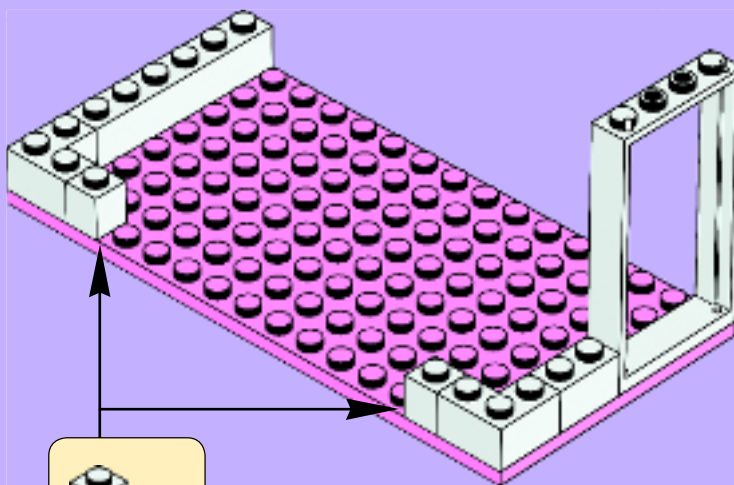

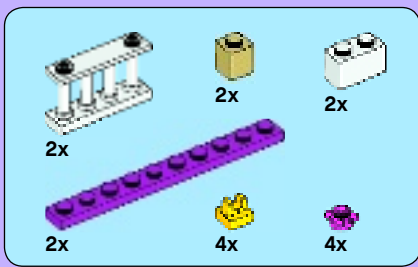

**3**

**1**

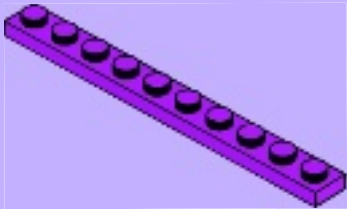

**2**

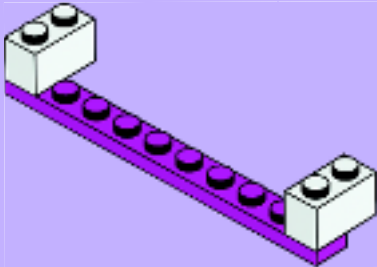

**3**

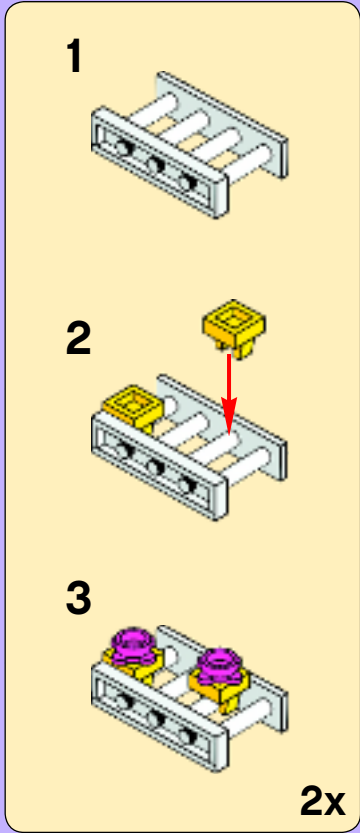
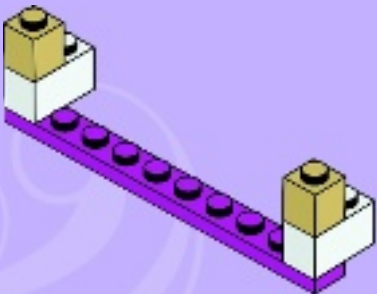

**4**

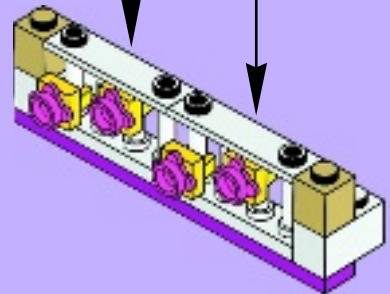



5

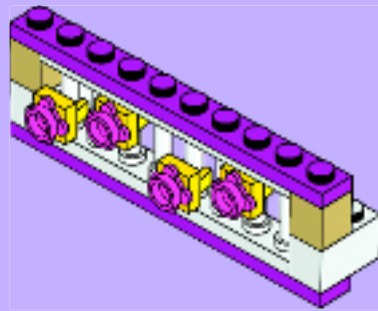

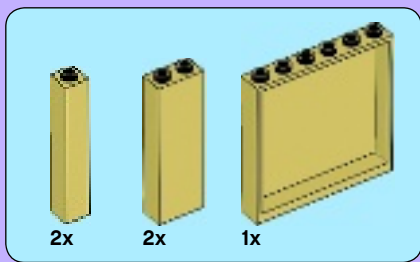

4

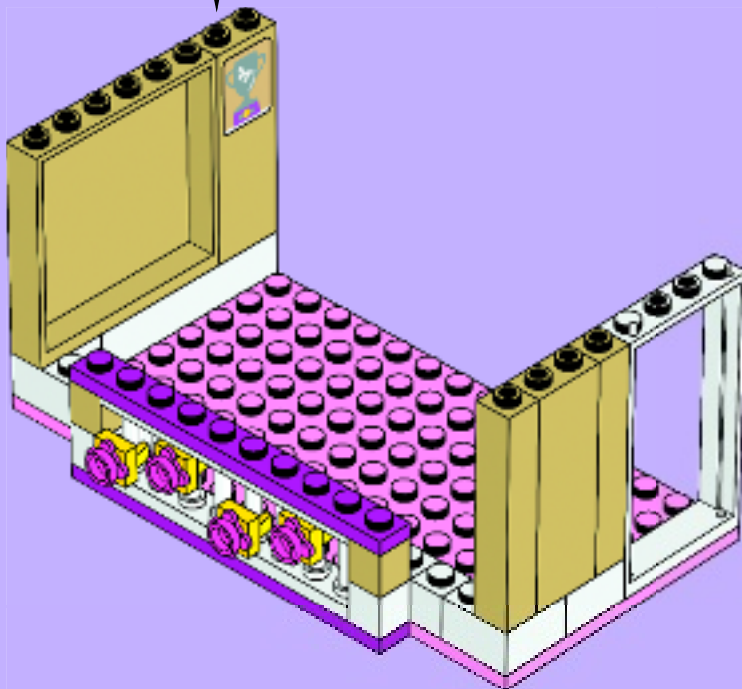
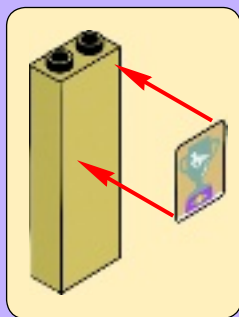

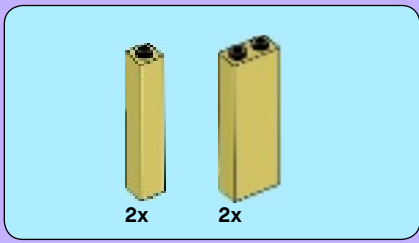

5

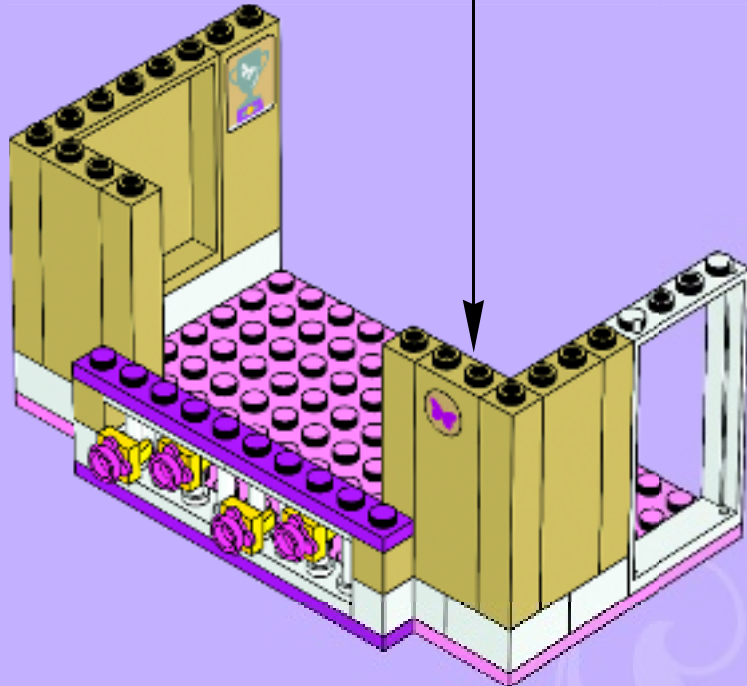
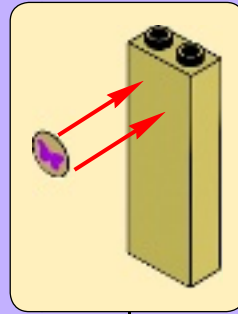

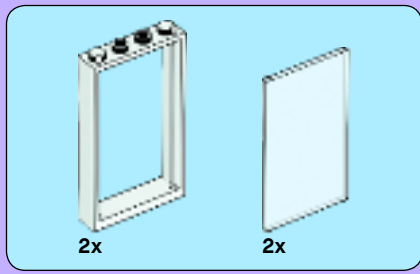

6

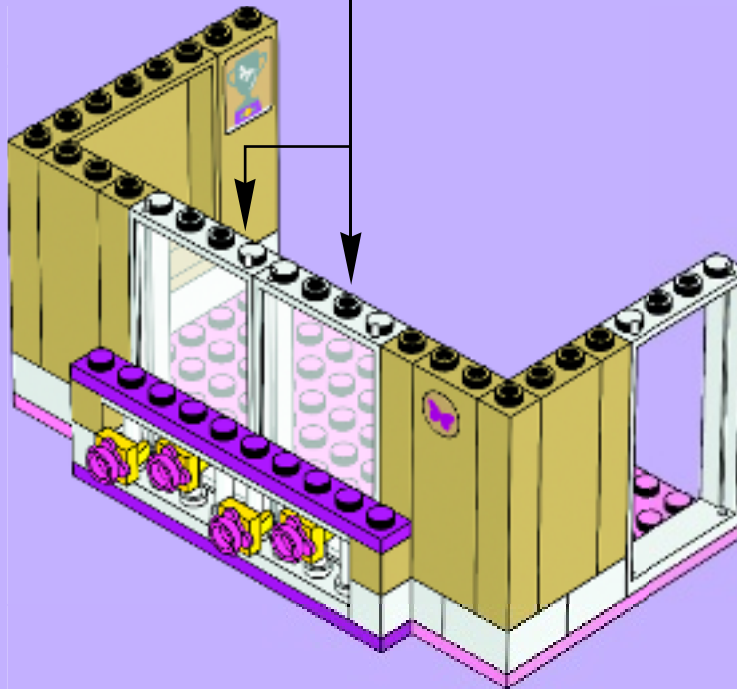
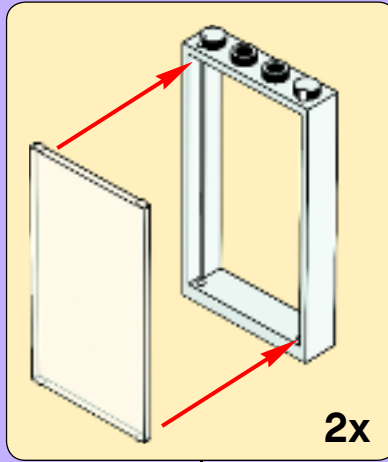

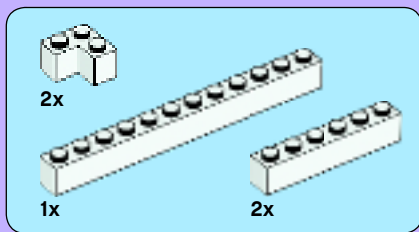

7



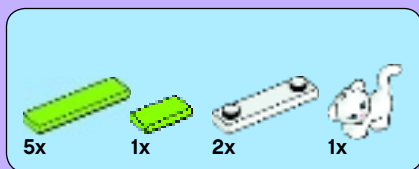

8

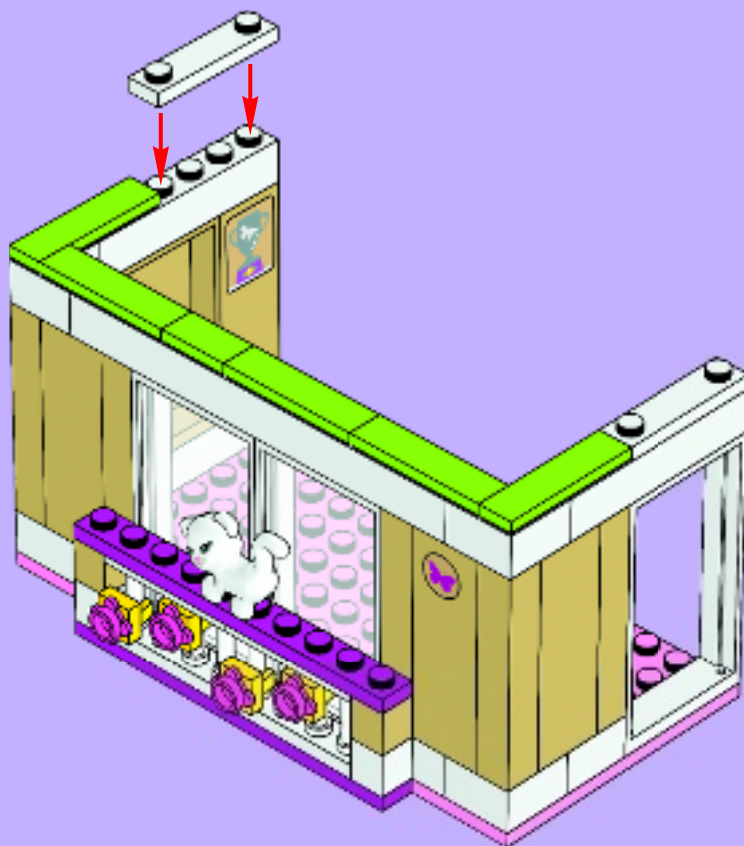



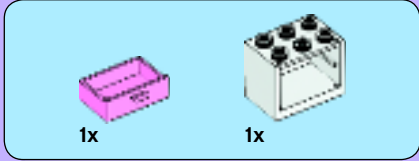
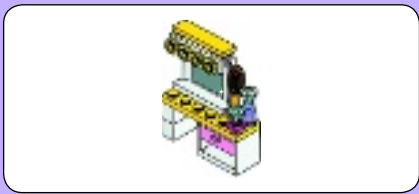

**1**

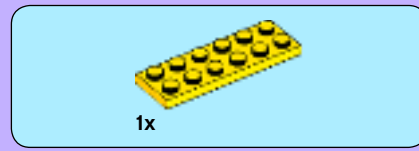
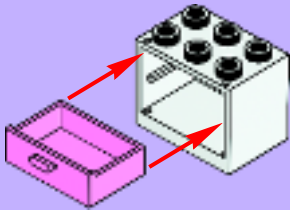

**2**

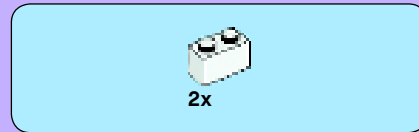

**3**

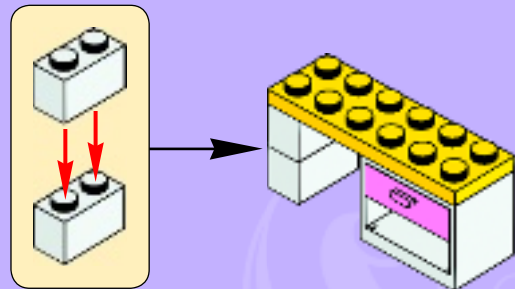



4

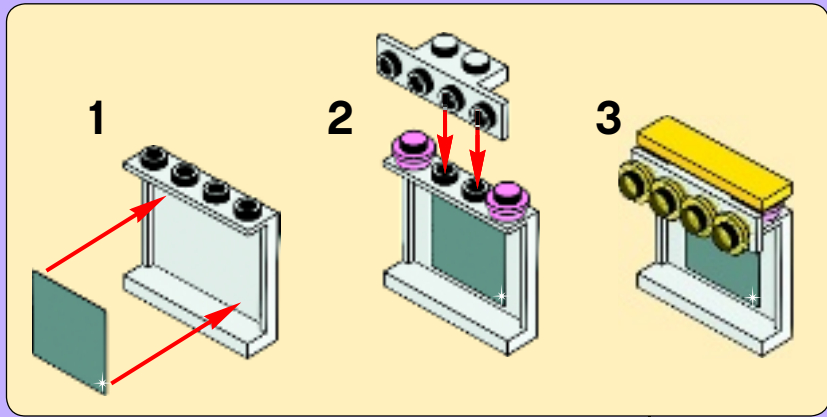

5



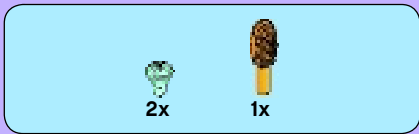

6

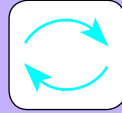

9





1x



1x

# 10

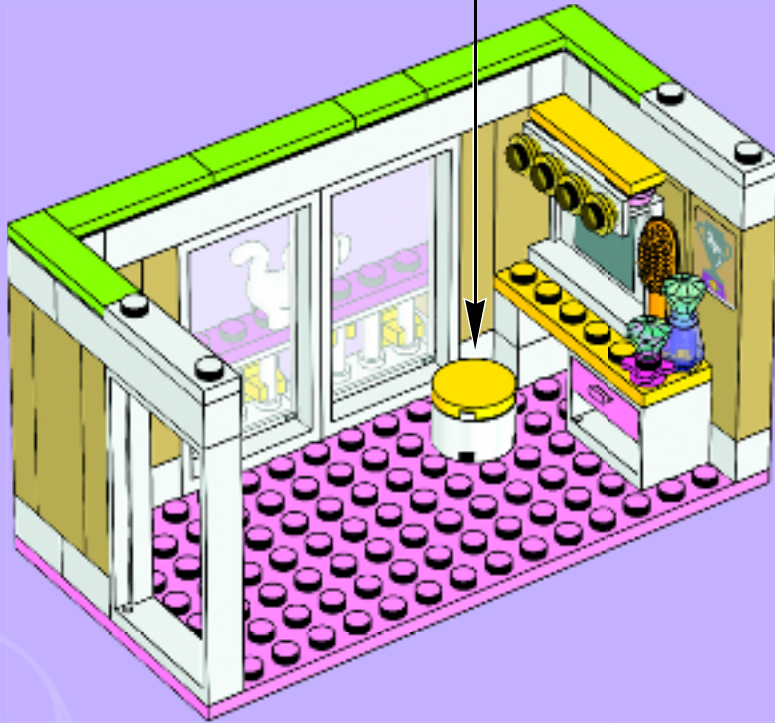
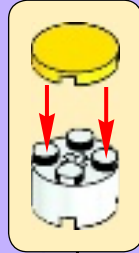

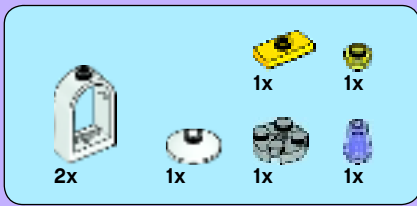

11

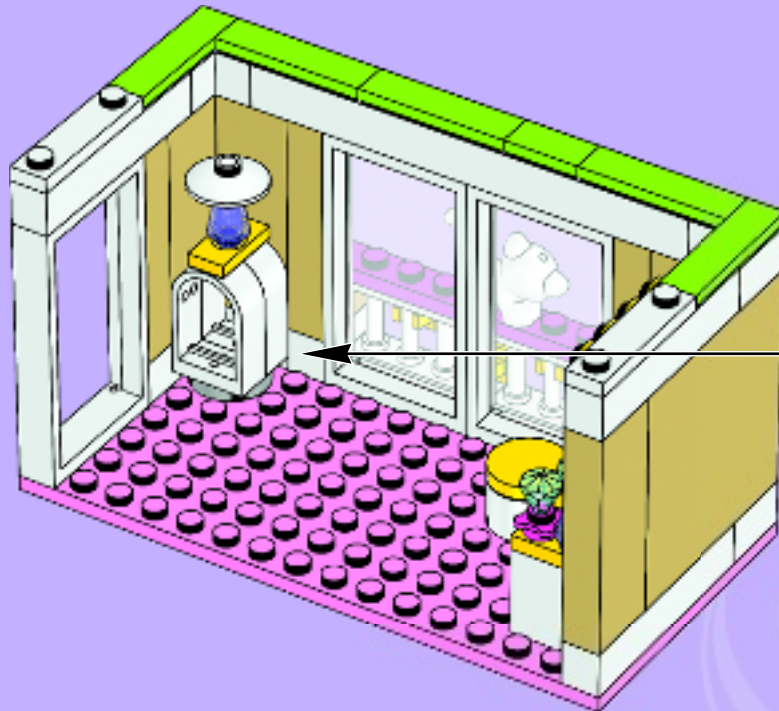
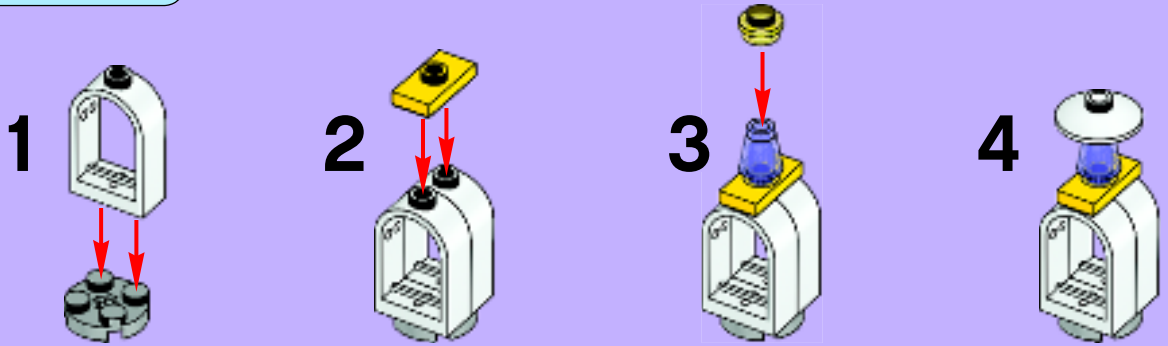

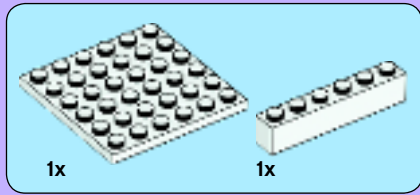

1

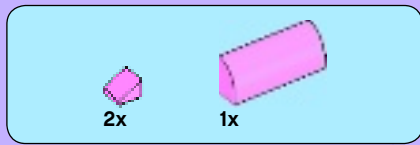

2

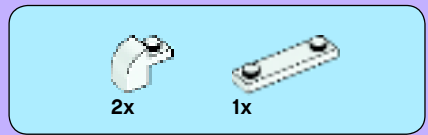
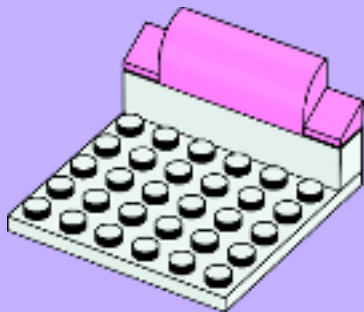

3

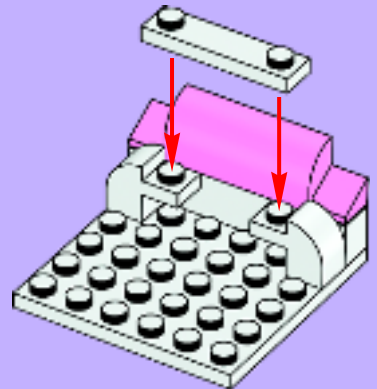



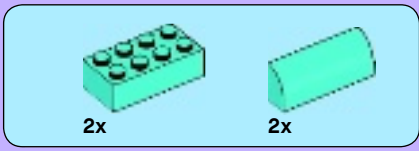

4

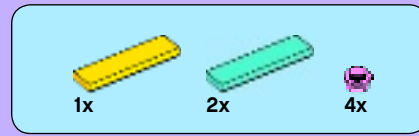
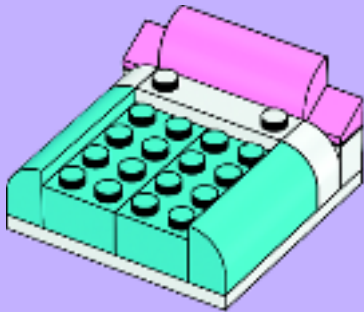

5

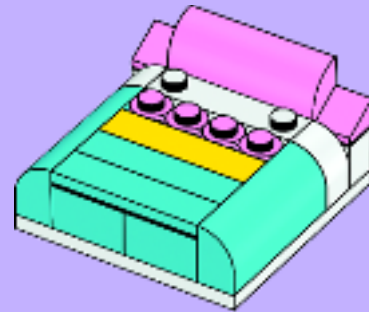



6

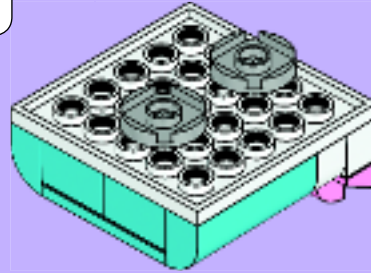
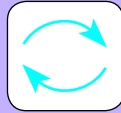

12





# 13

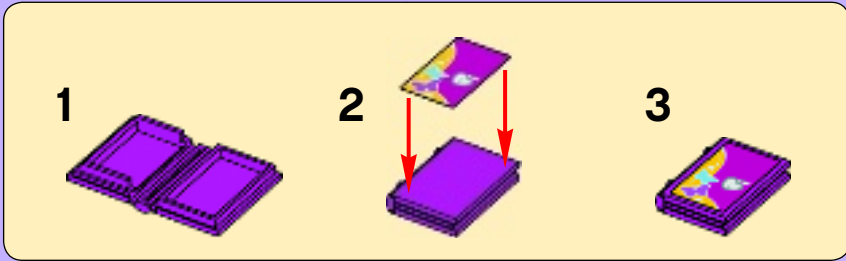



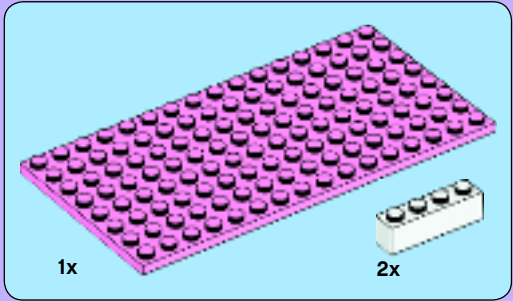
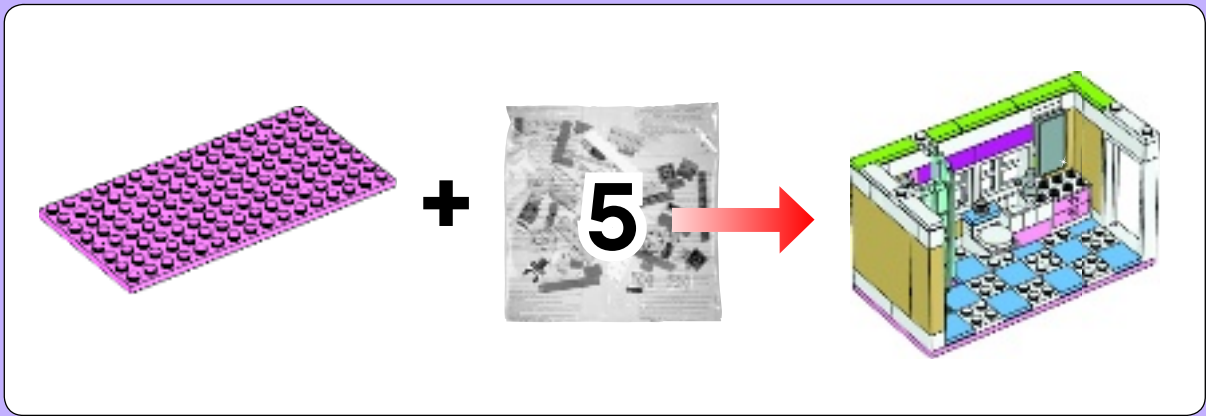

1

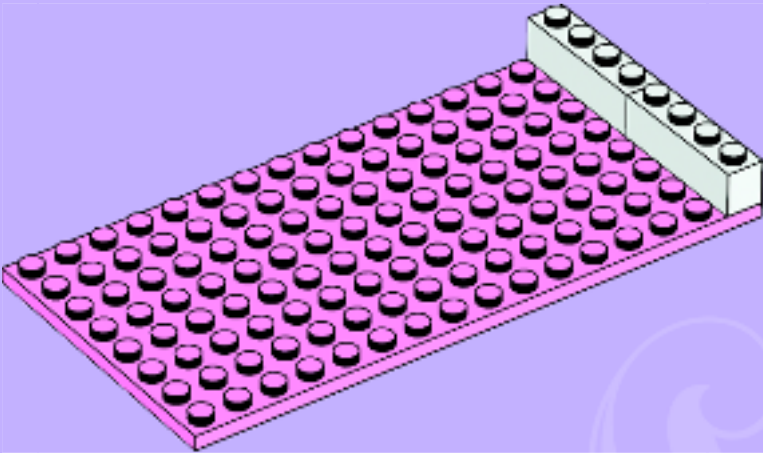

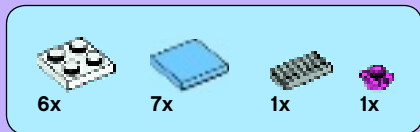

2

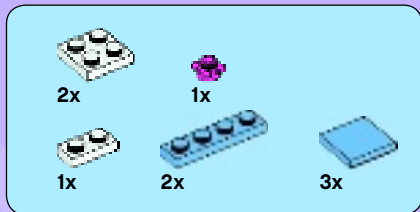
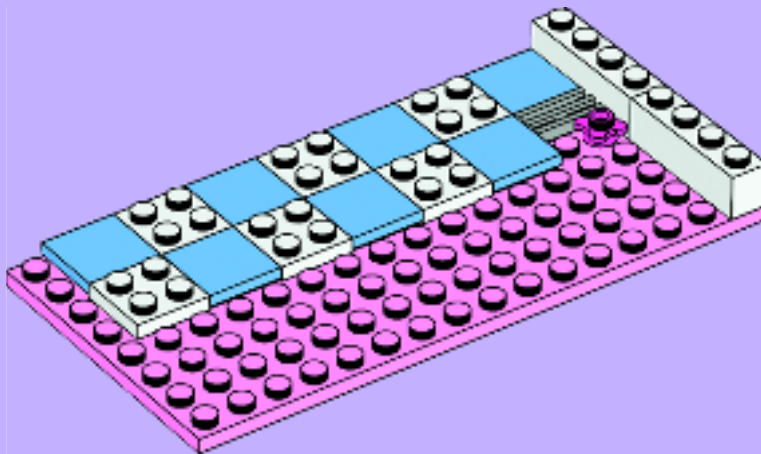

3

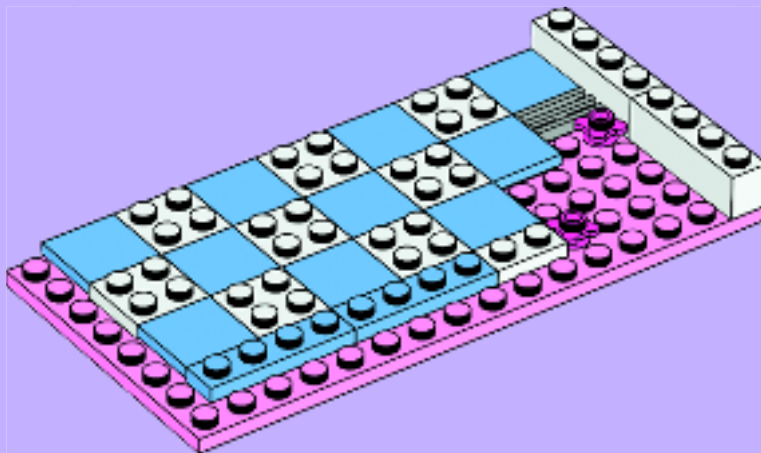



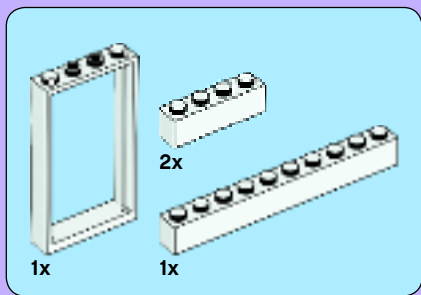

4

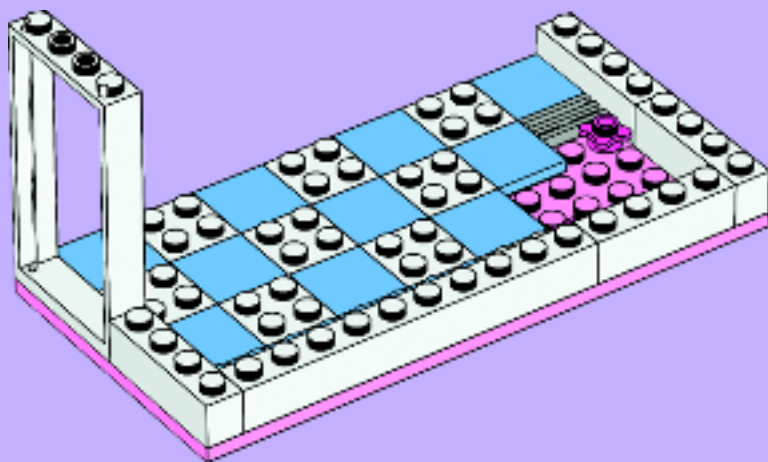

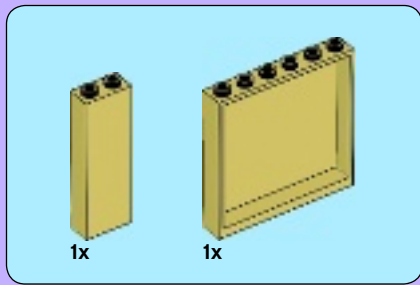

5

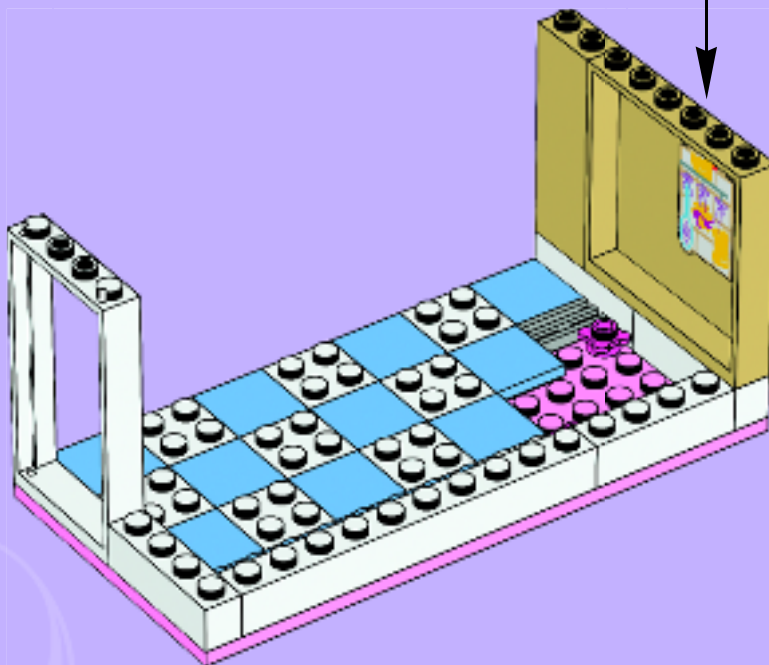
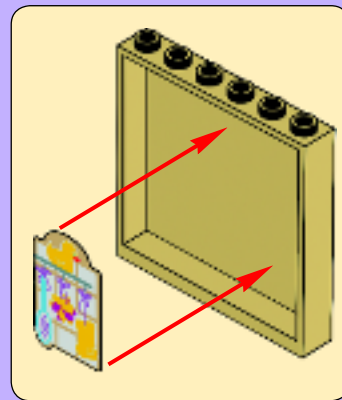

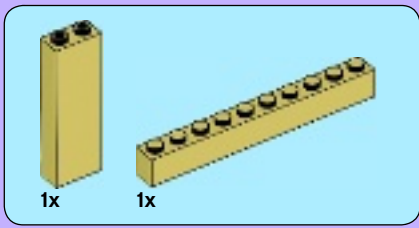

6

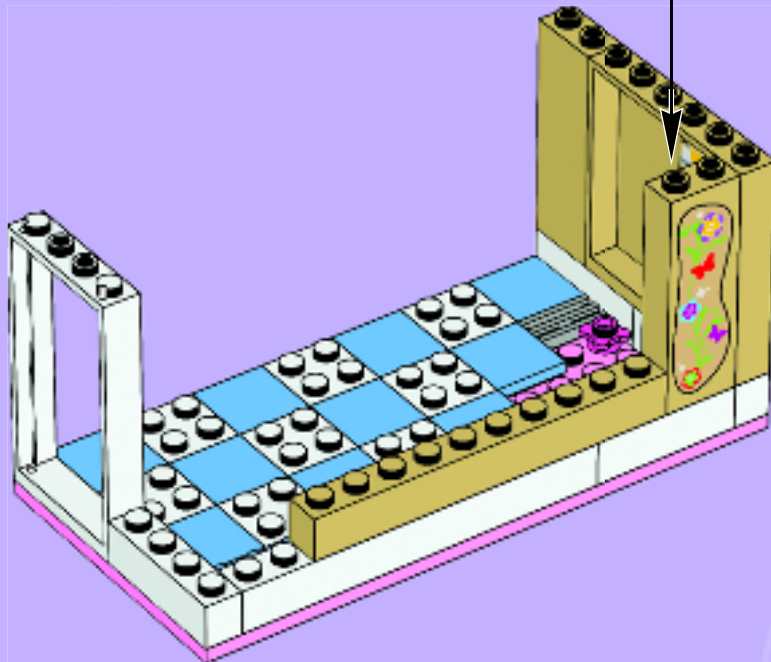
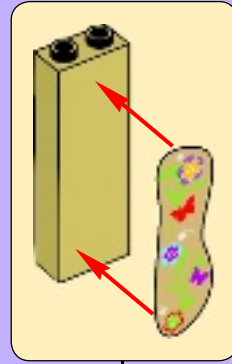

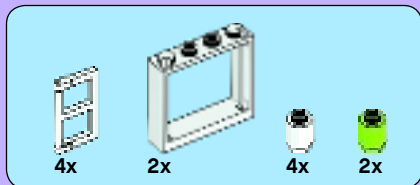

7

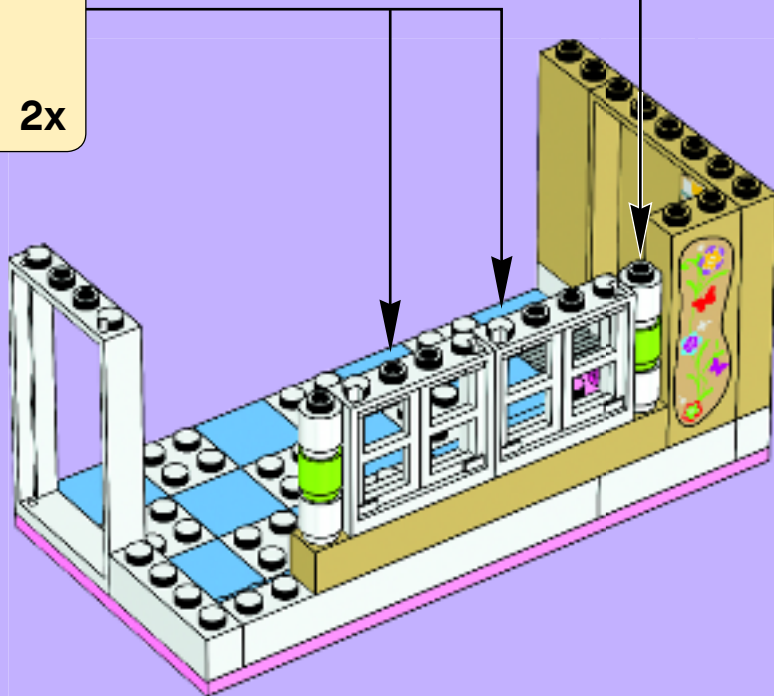
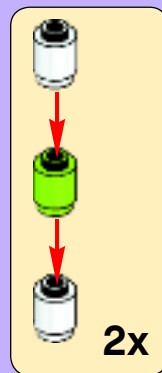
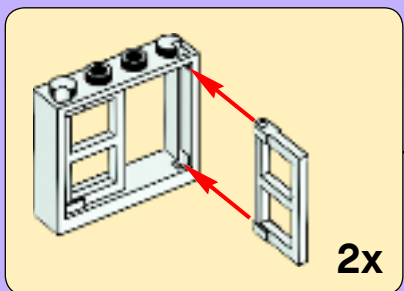

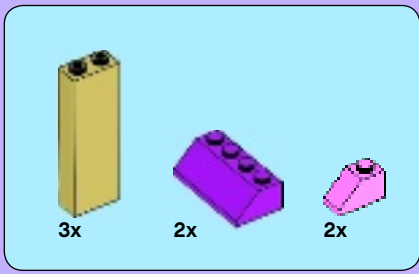

8

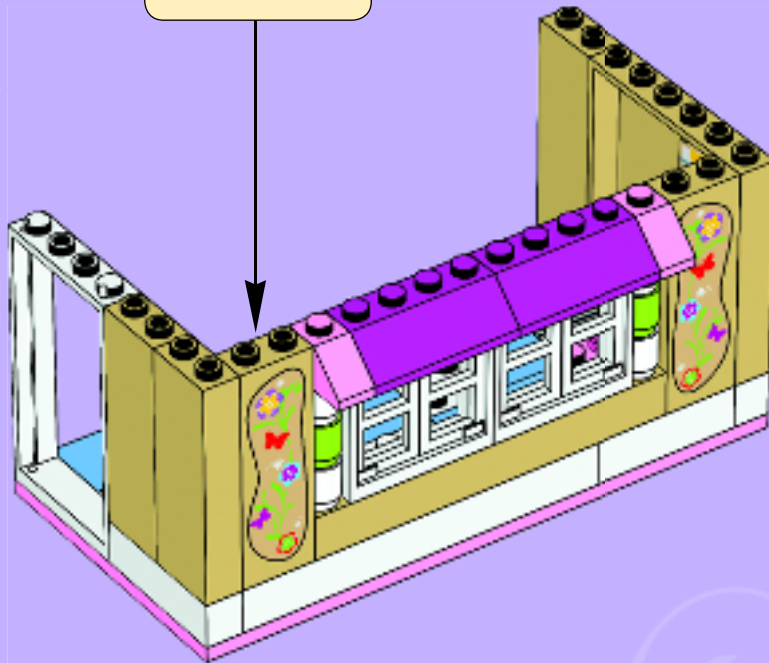
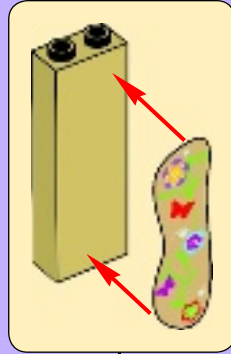



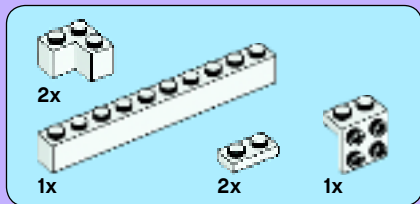

9

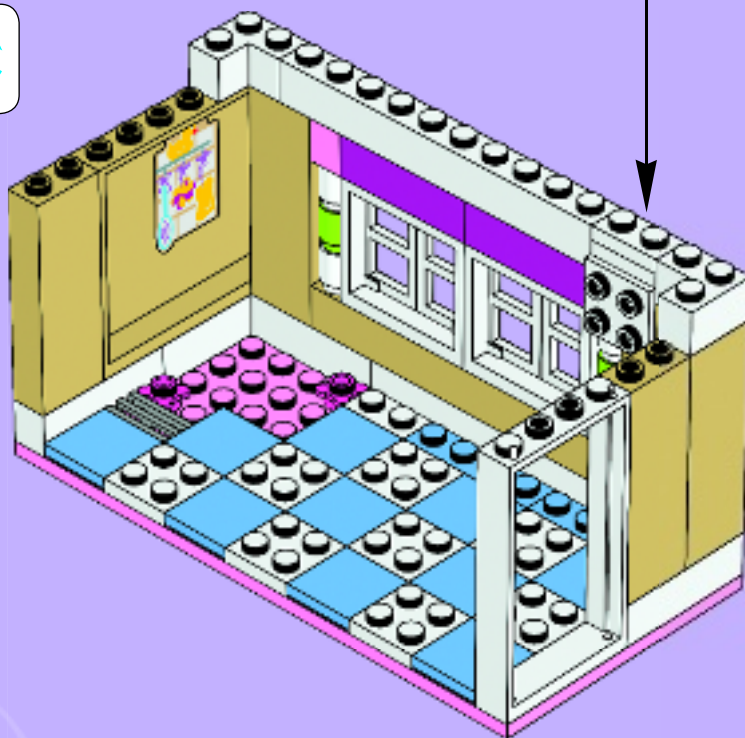
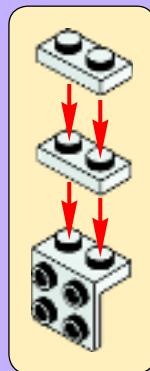
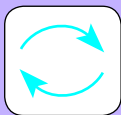

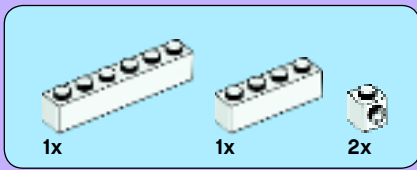

# 10



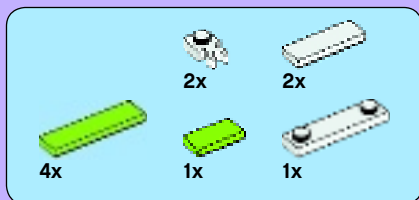

11





1x



1x

# 12

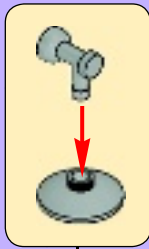

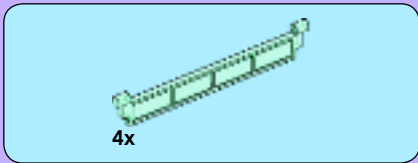

13

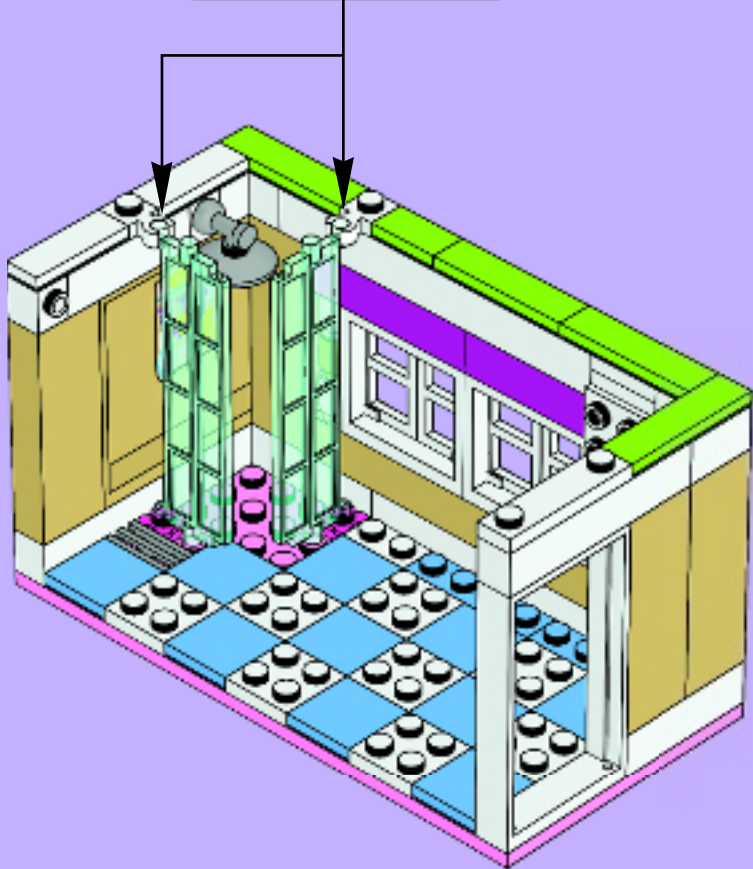
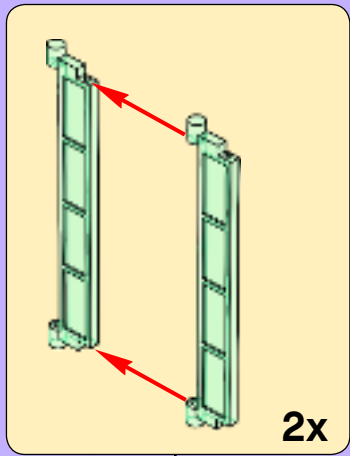

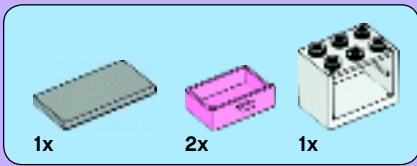

14

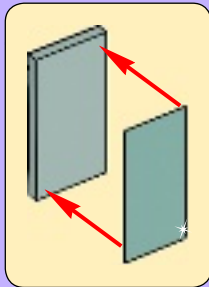
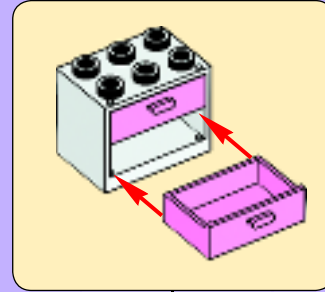





# 15

1



2

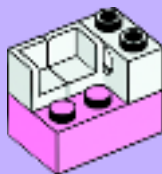

3



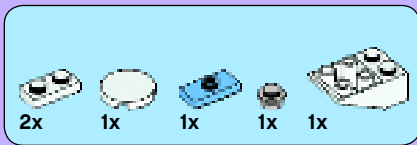

# 16

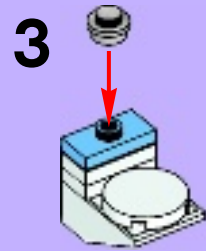
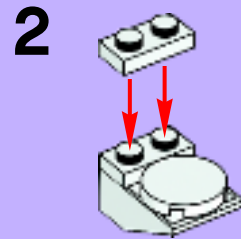
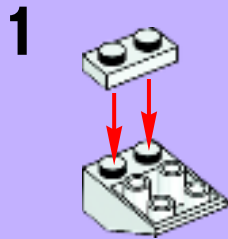



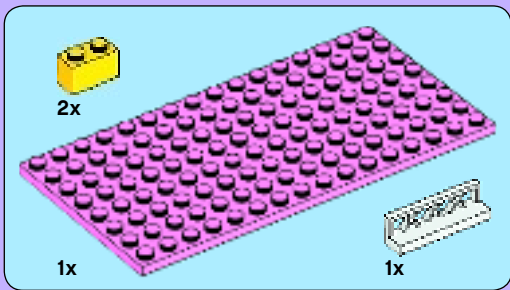
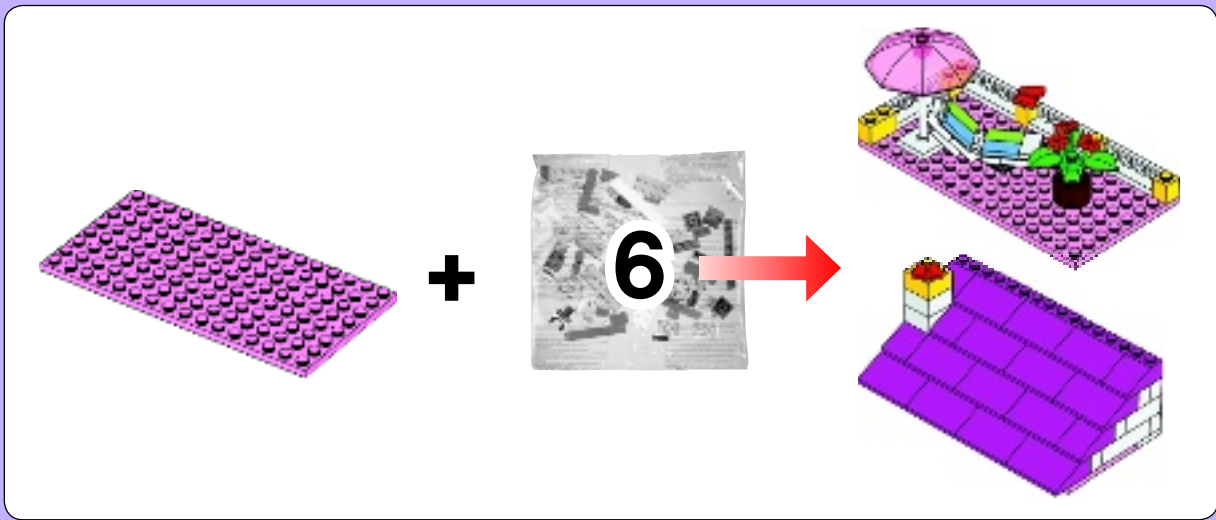

1

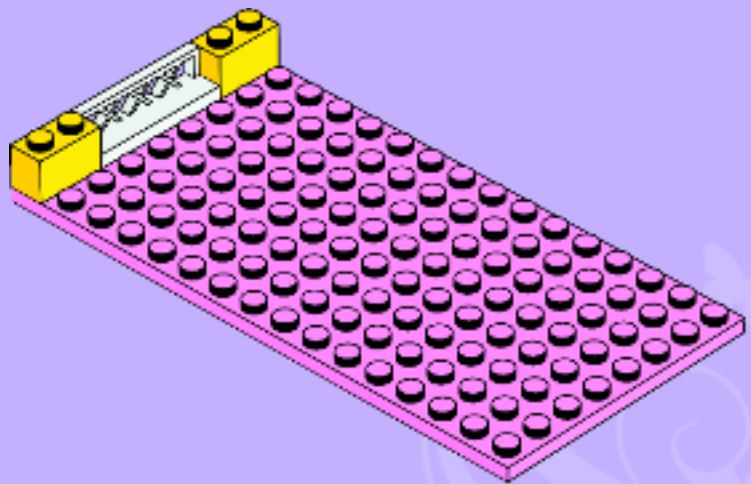



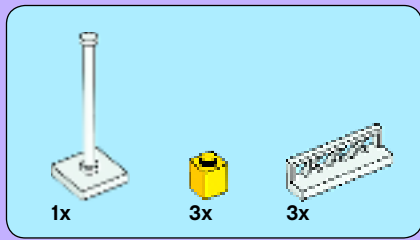

2

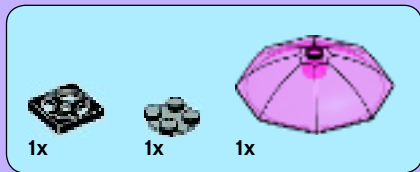
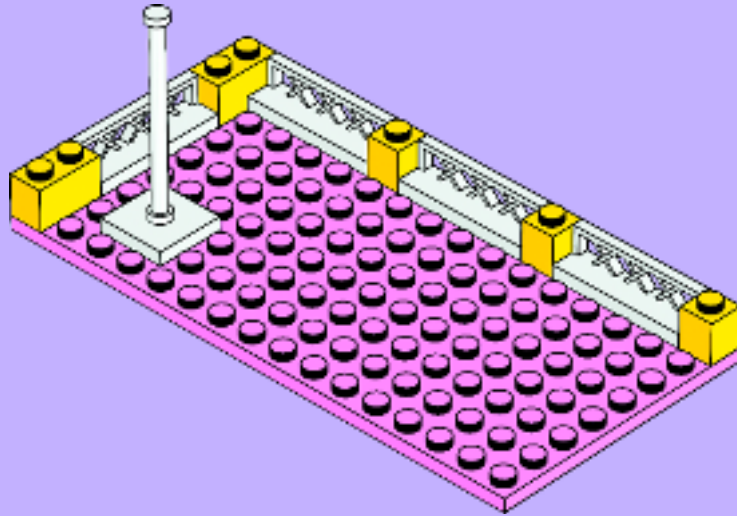

3

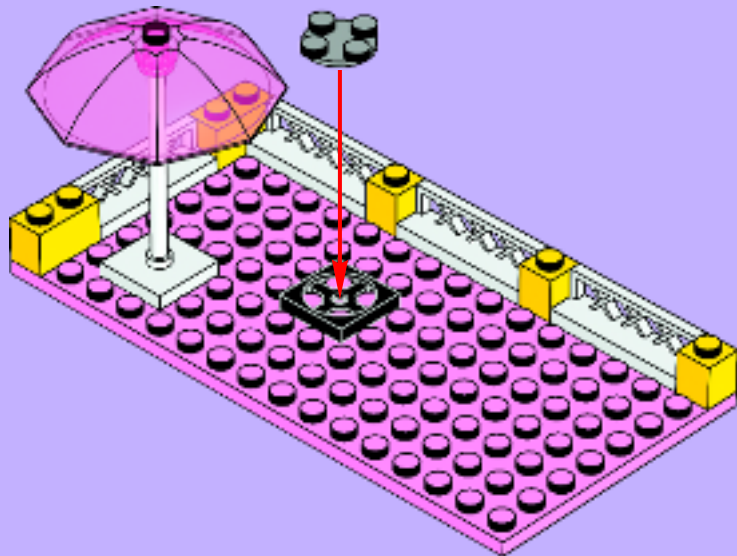

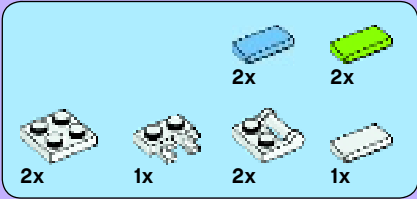

4

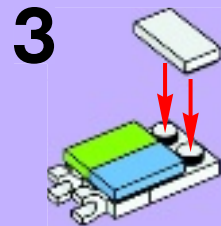
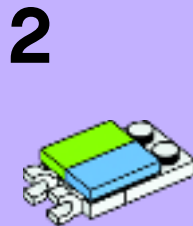
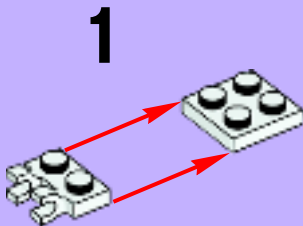



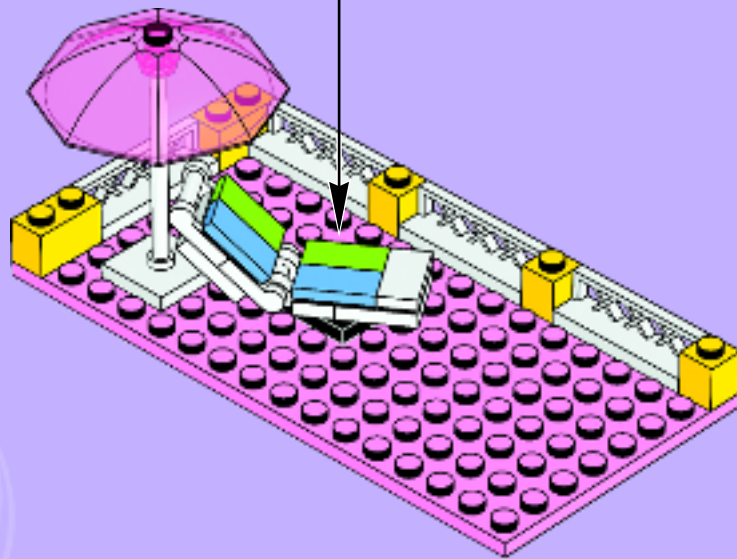
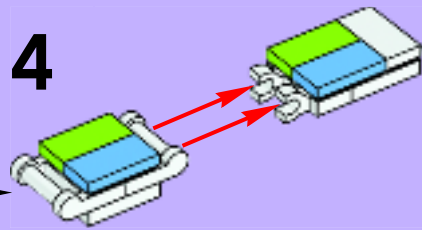



5

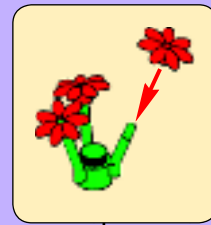
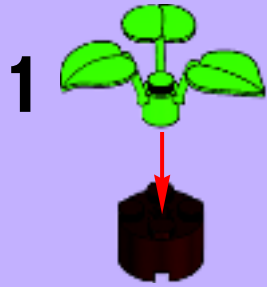

2

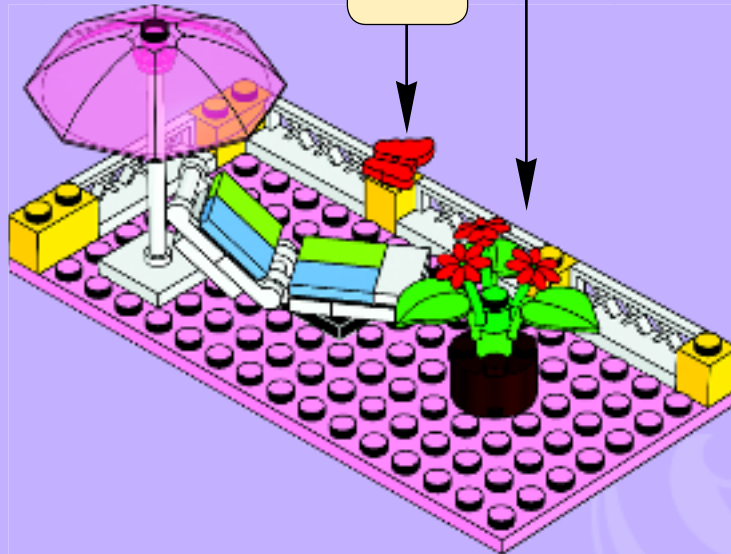



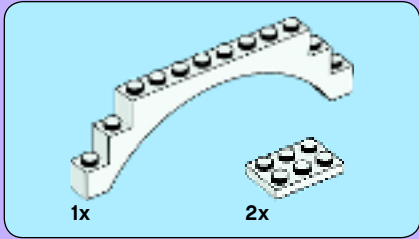
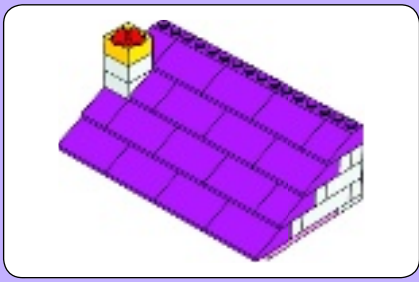

1

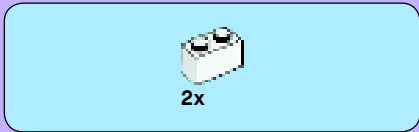
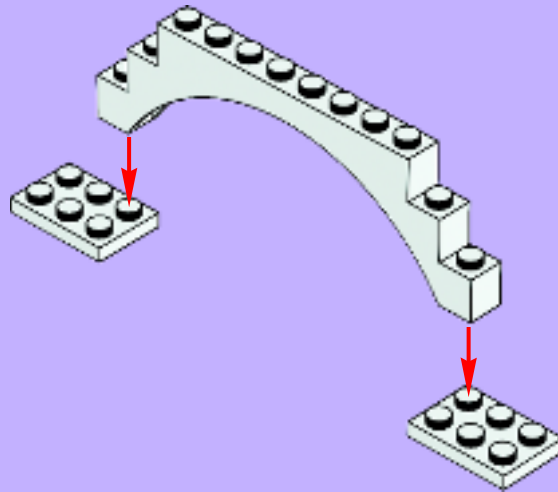

2

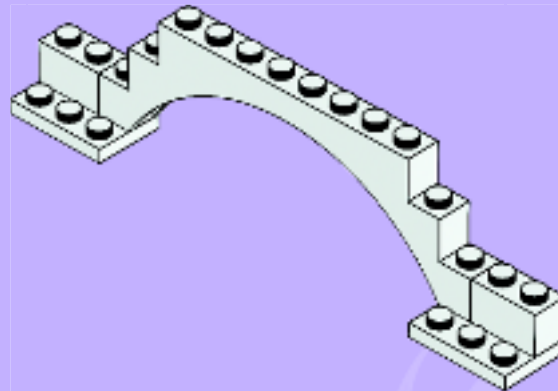



2x

3

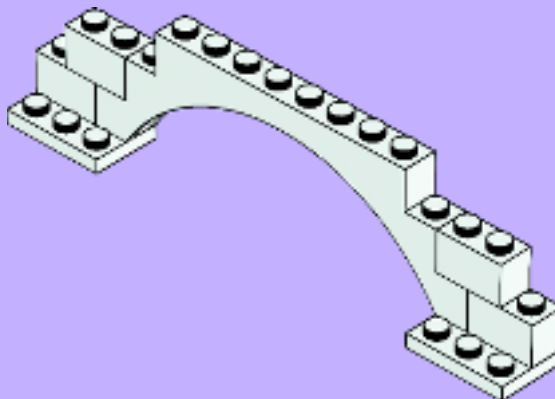

2x

4

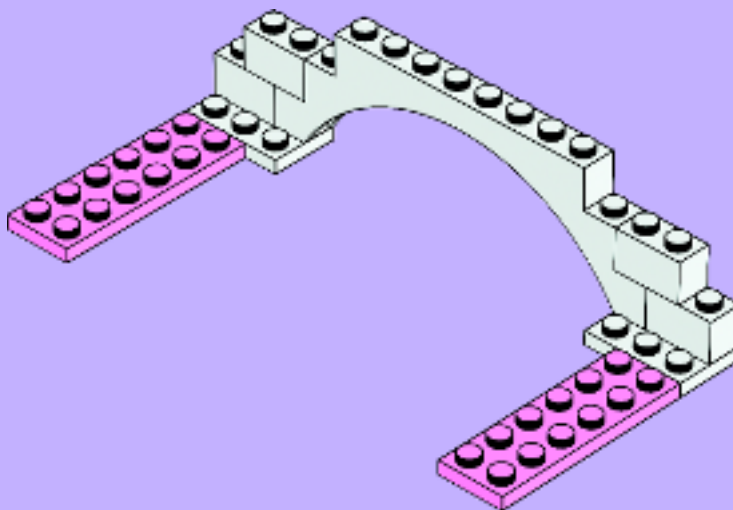



2x

5

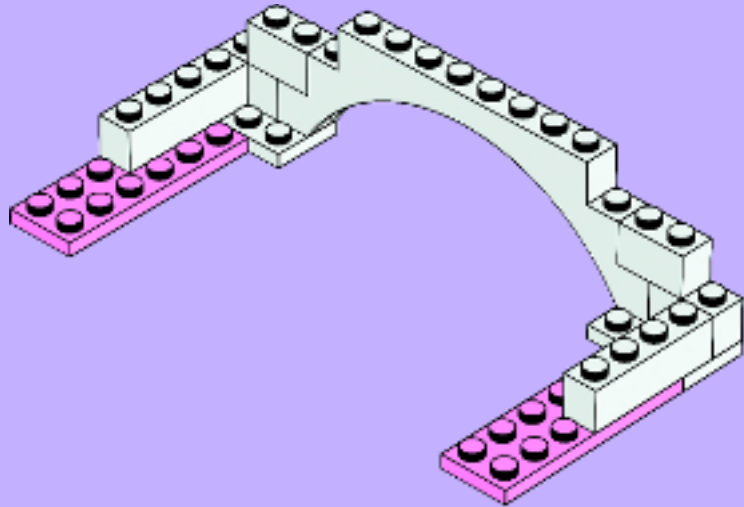

2x



2x

6

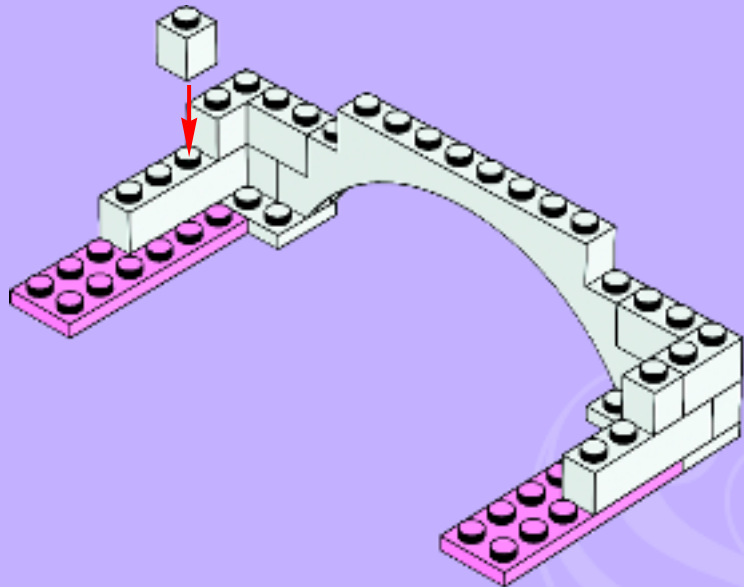



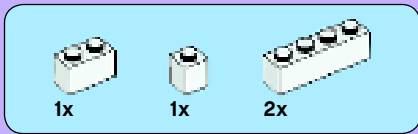

7

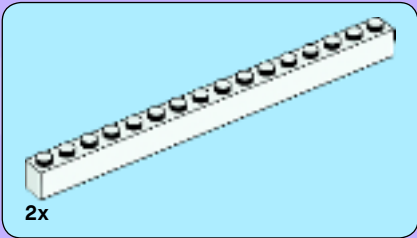
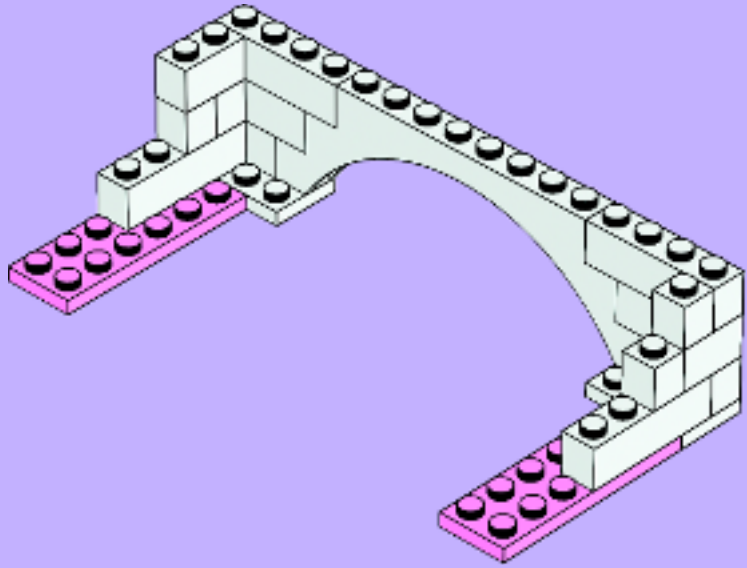

8

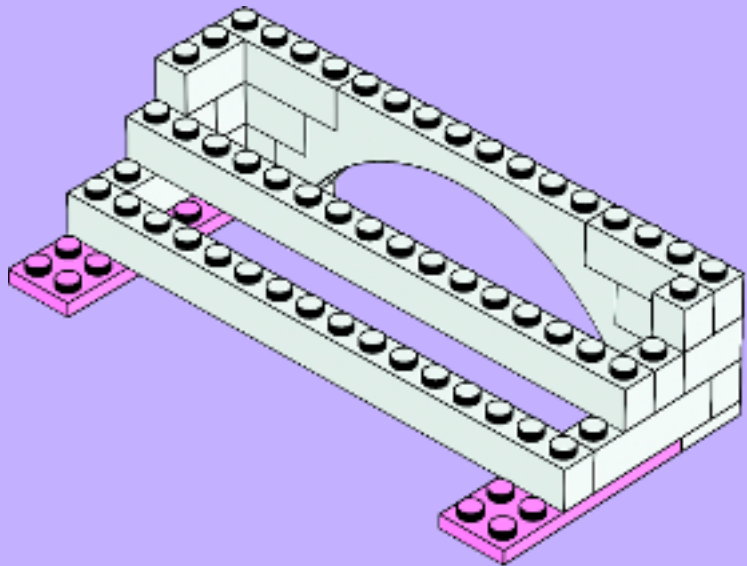

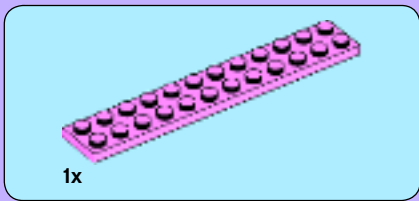

9

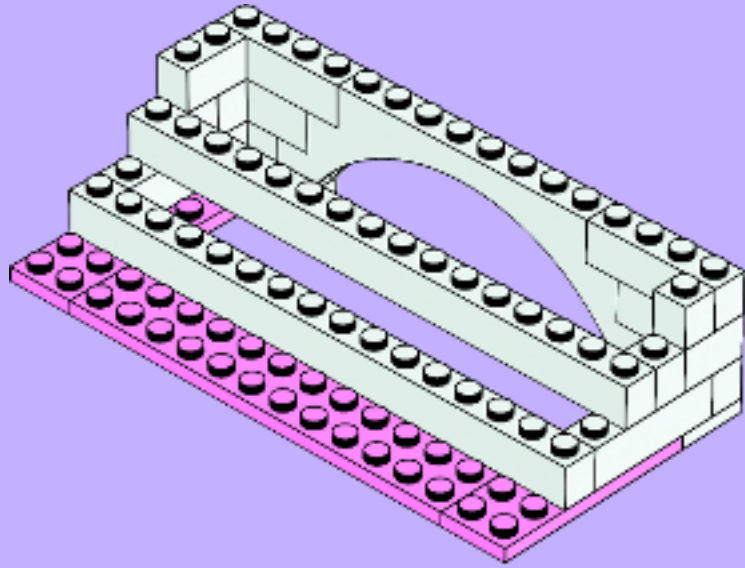

10

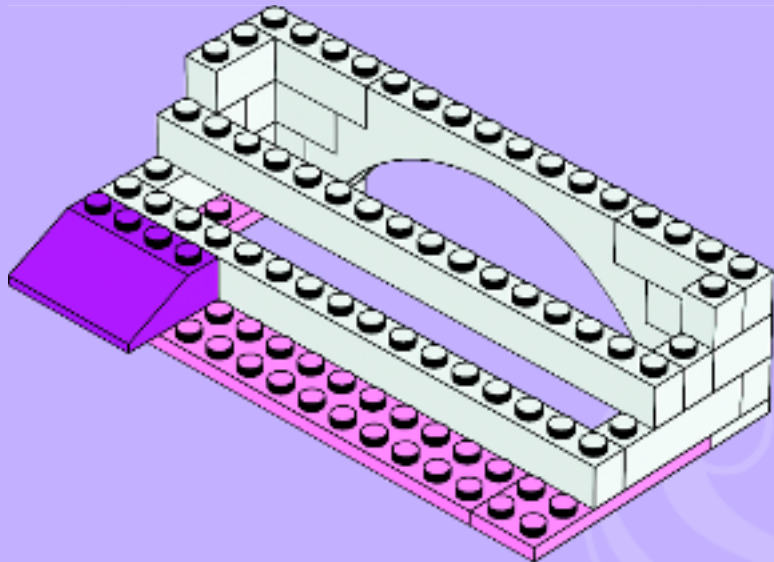



3x

# 11

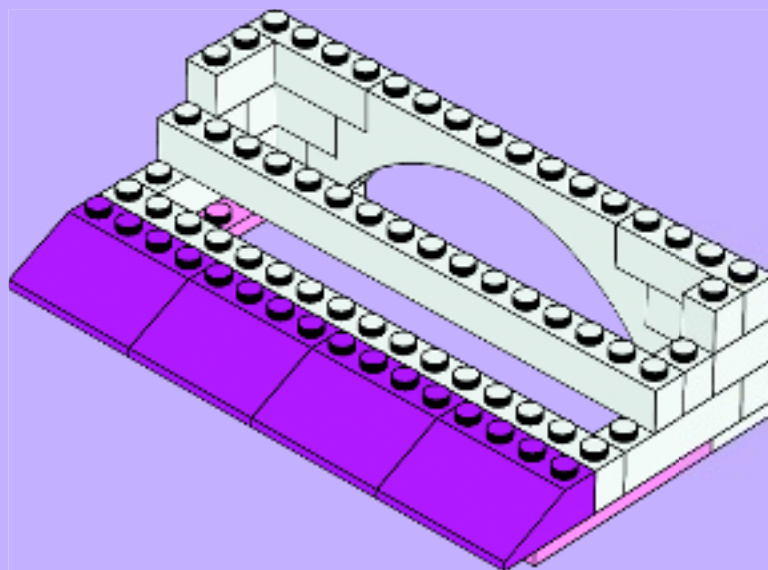

2x



3x

# 12

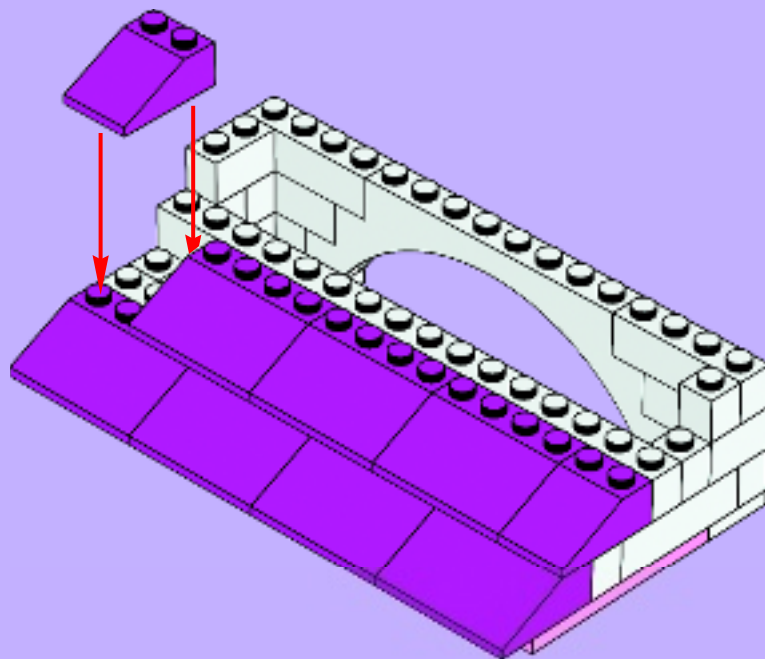



13

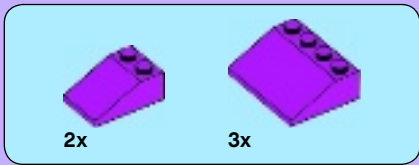
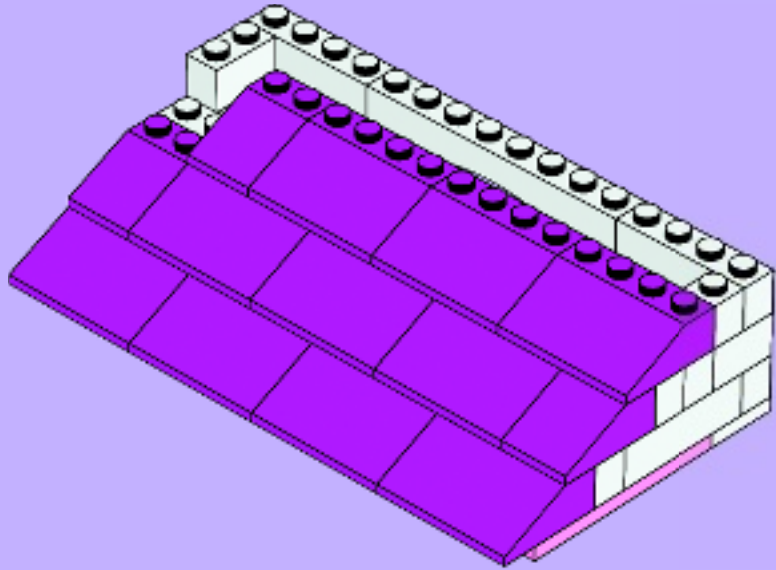

14

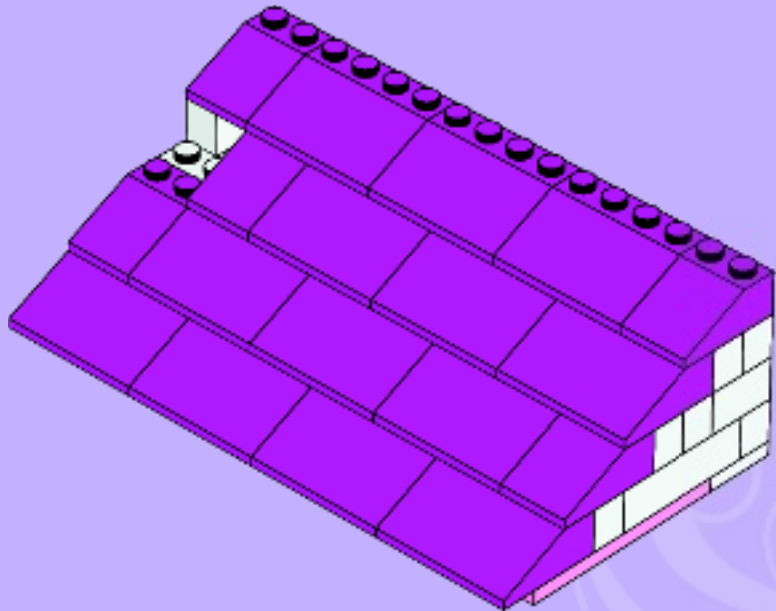



# 15

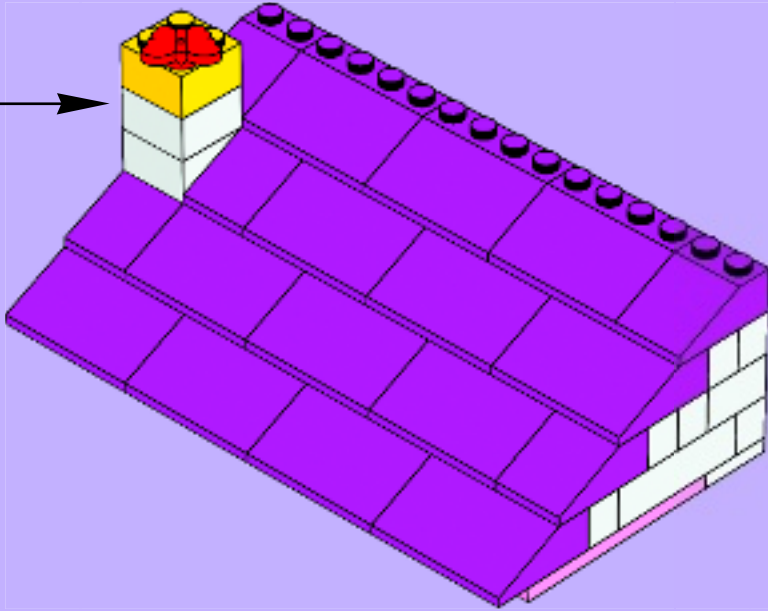
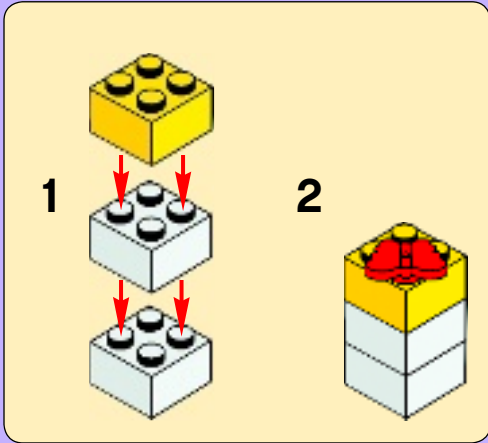







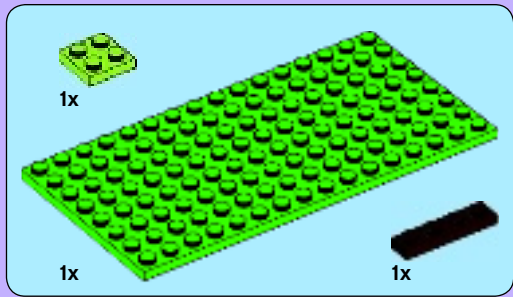
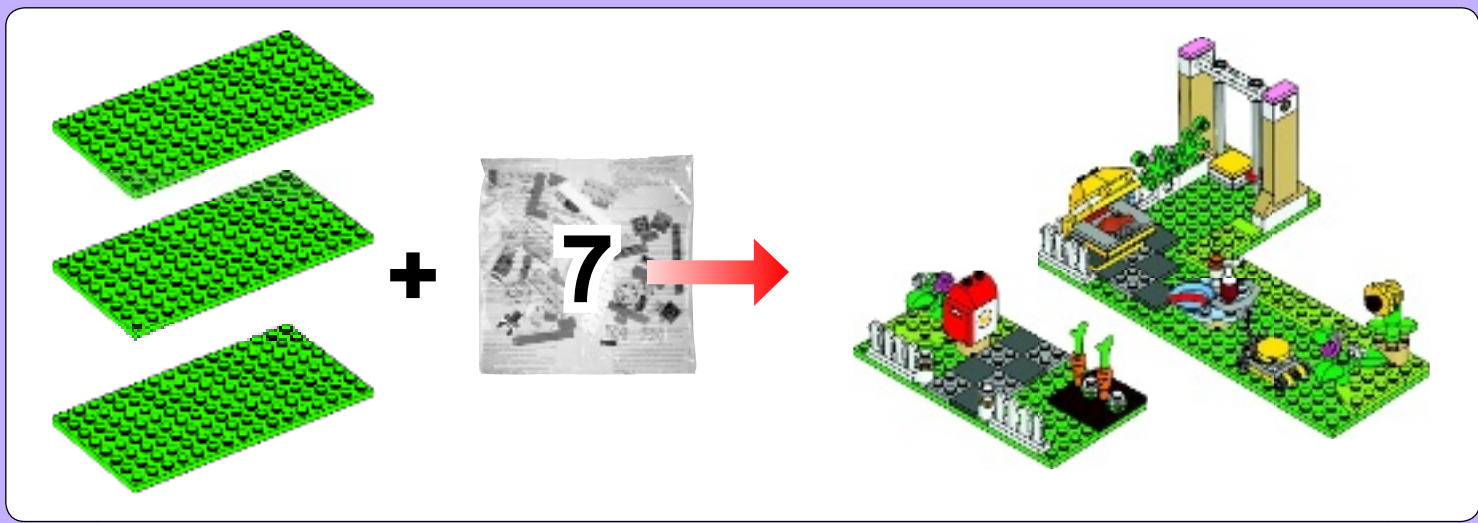

1

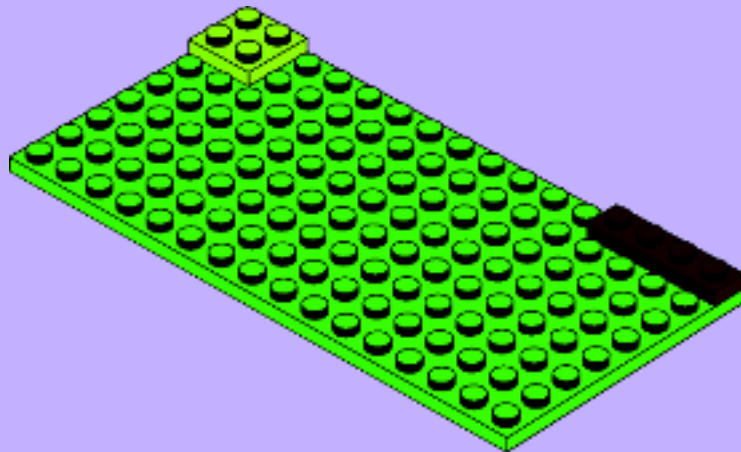



2

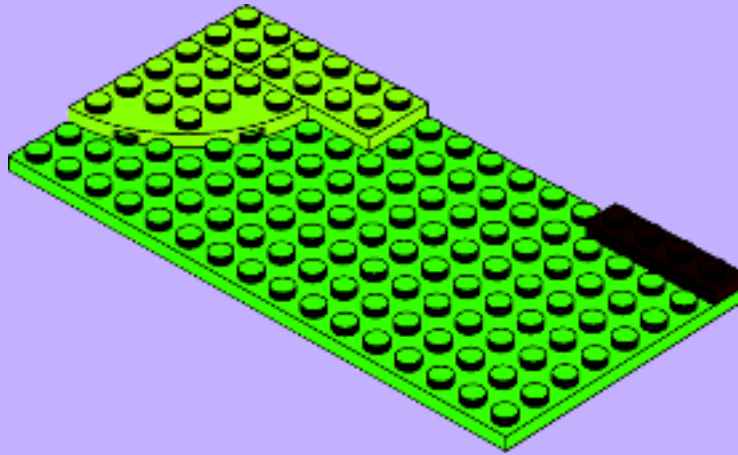

3

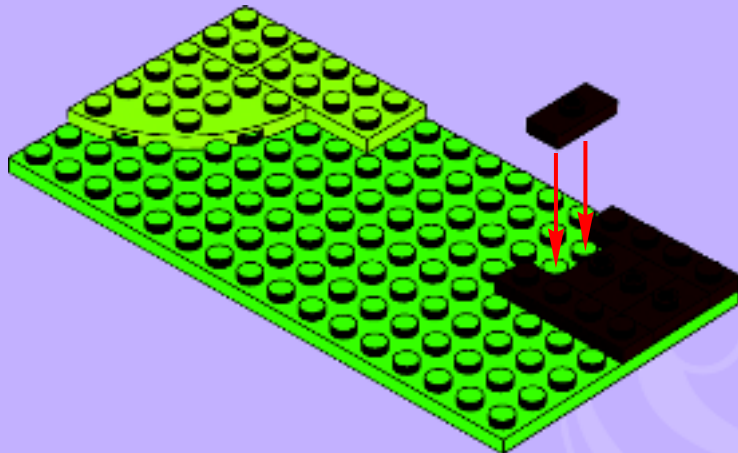



4

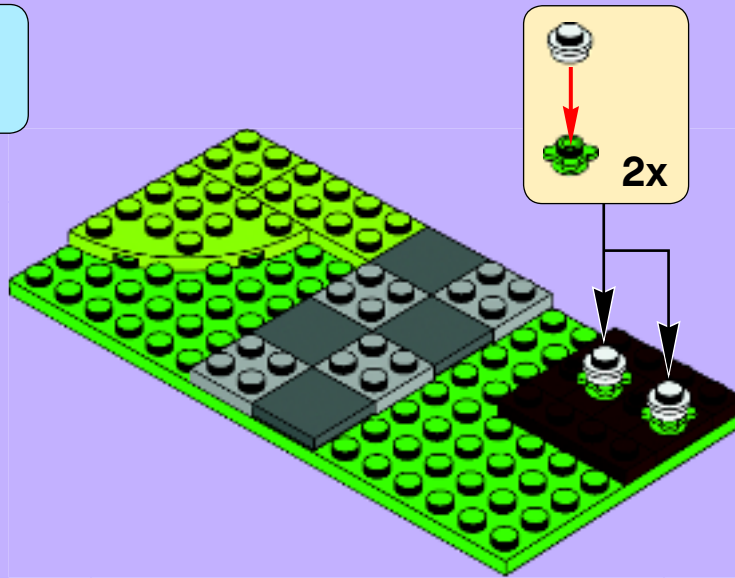

5

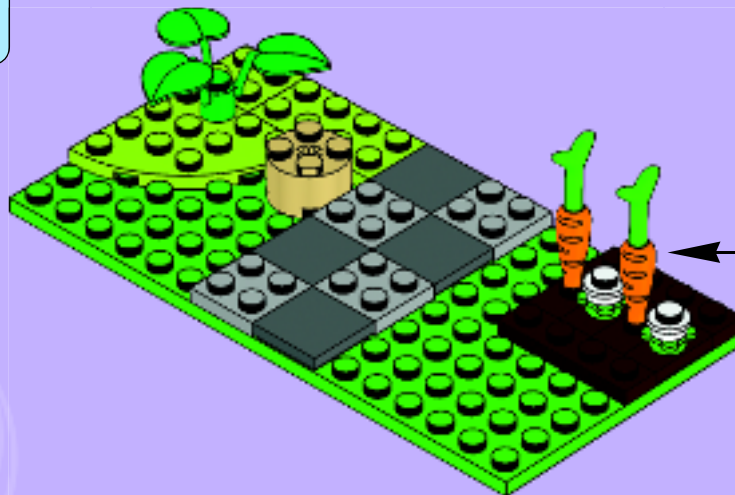

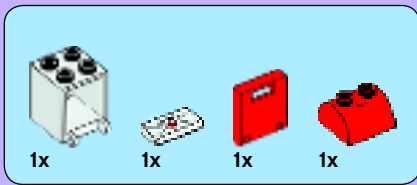

# 6

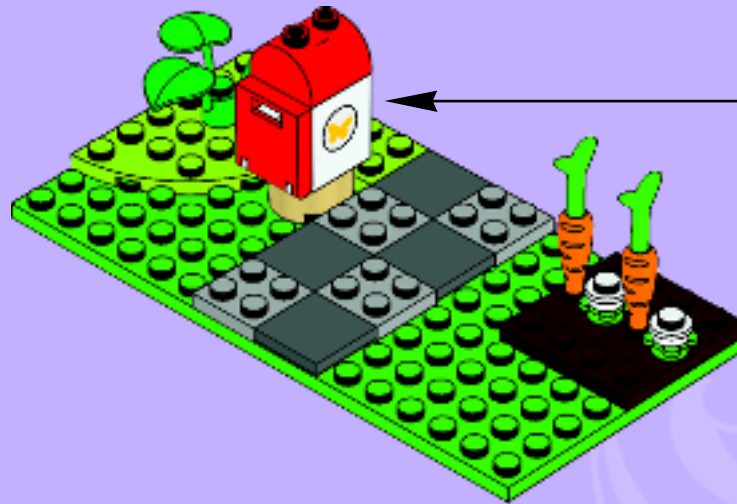
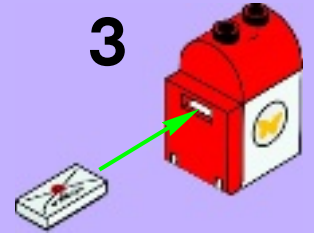
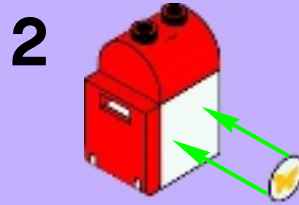
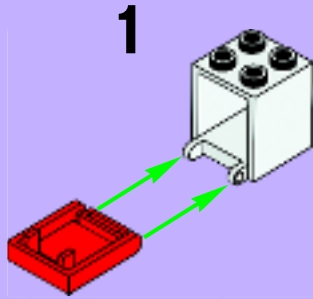

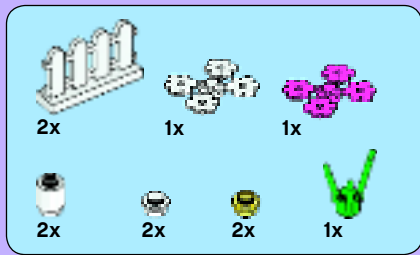

7

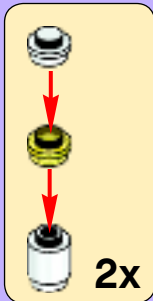
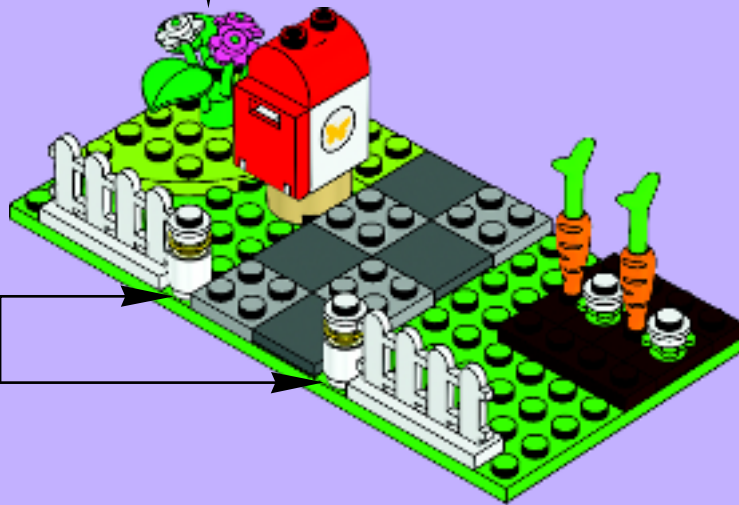
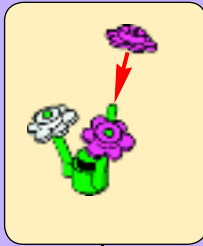







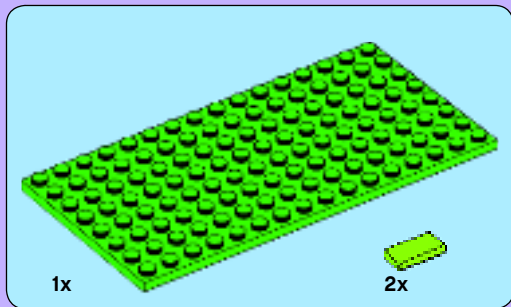

1

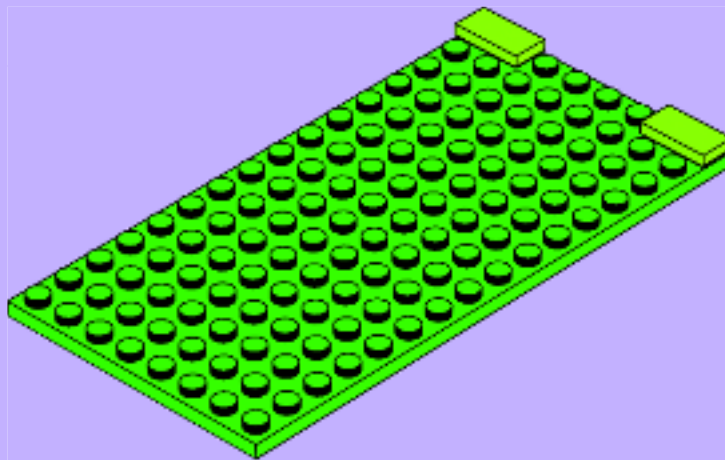

2

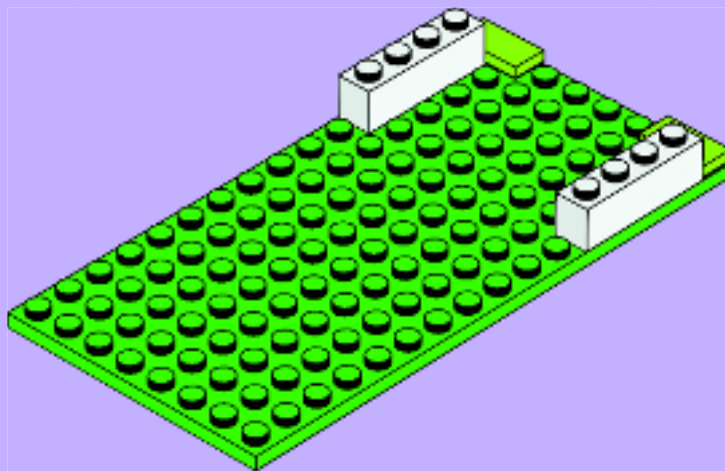

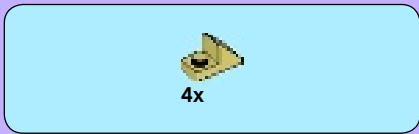

3

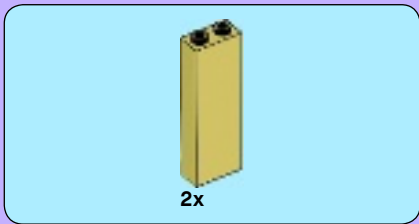
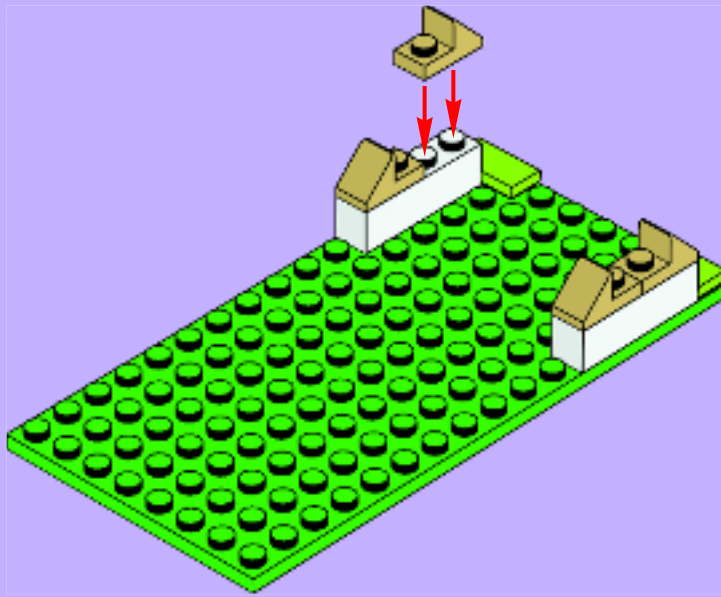

4

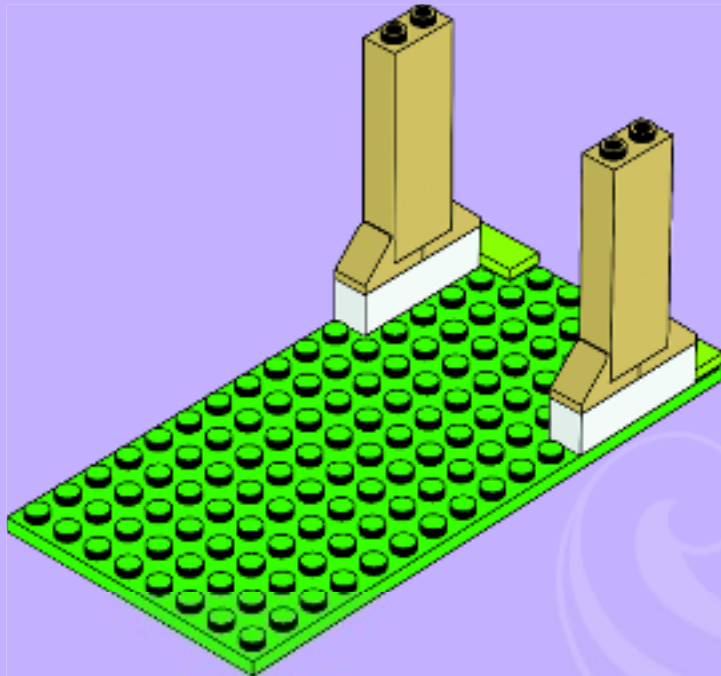

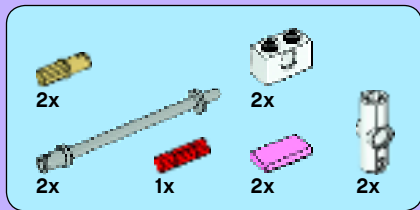

5

1

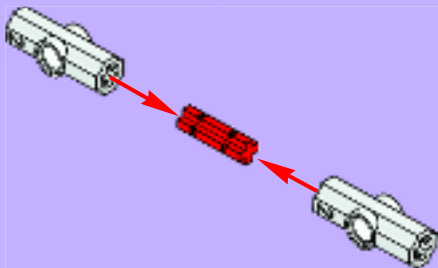

2

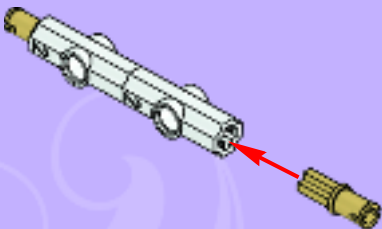

3

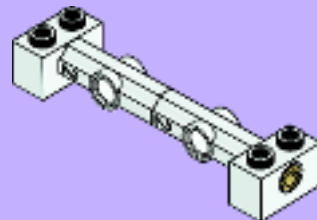

4

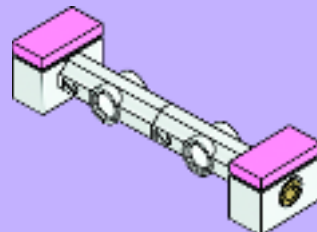

5

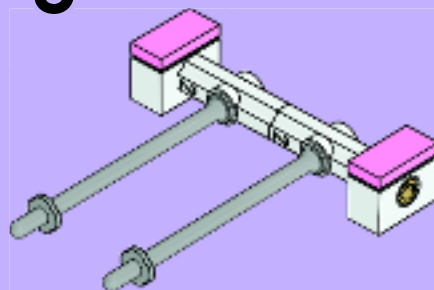

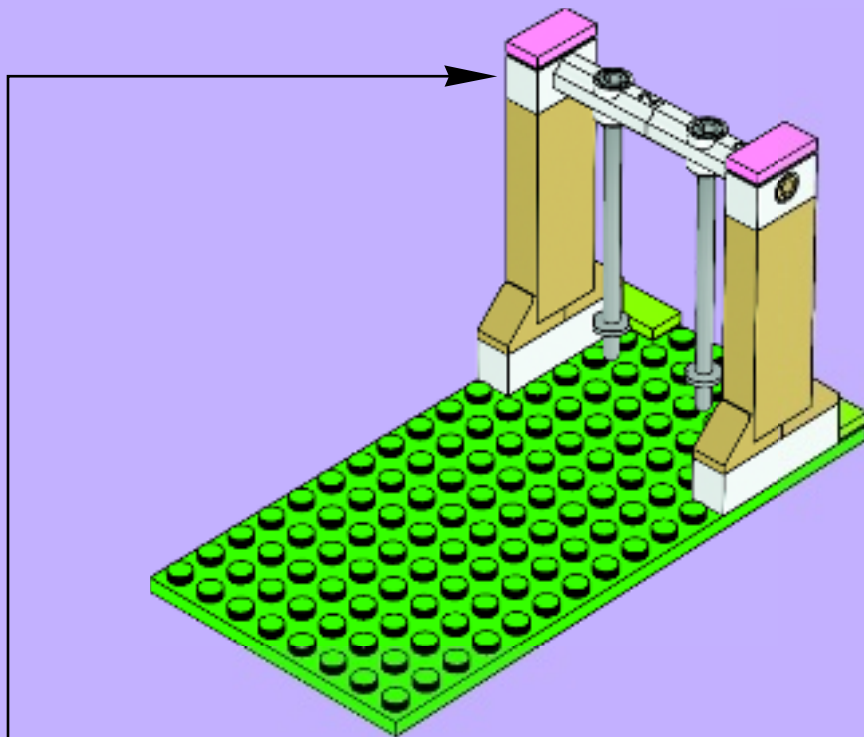



6

1



2



3

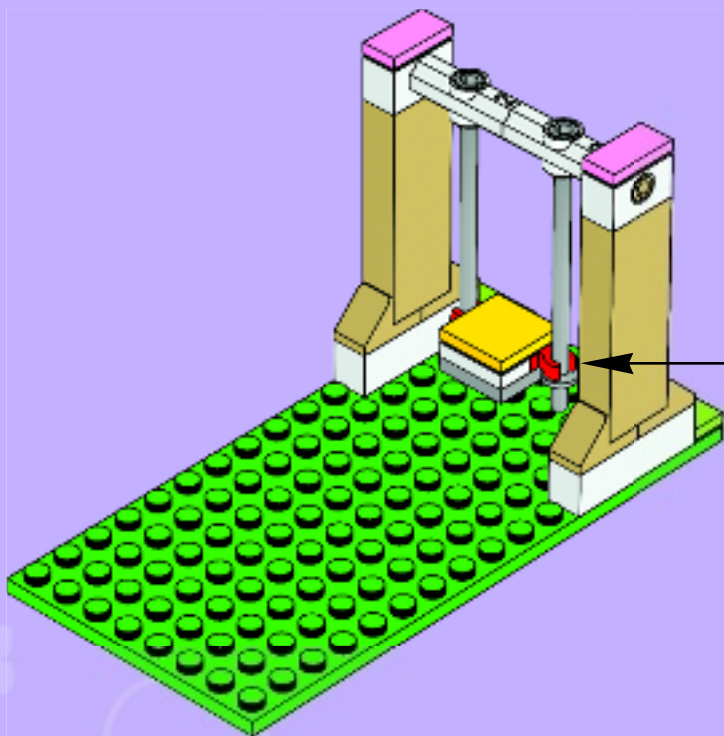



7

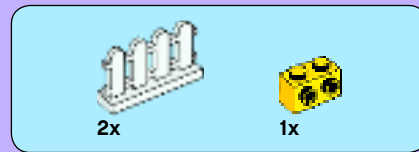
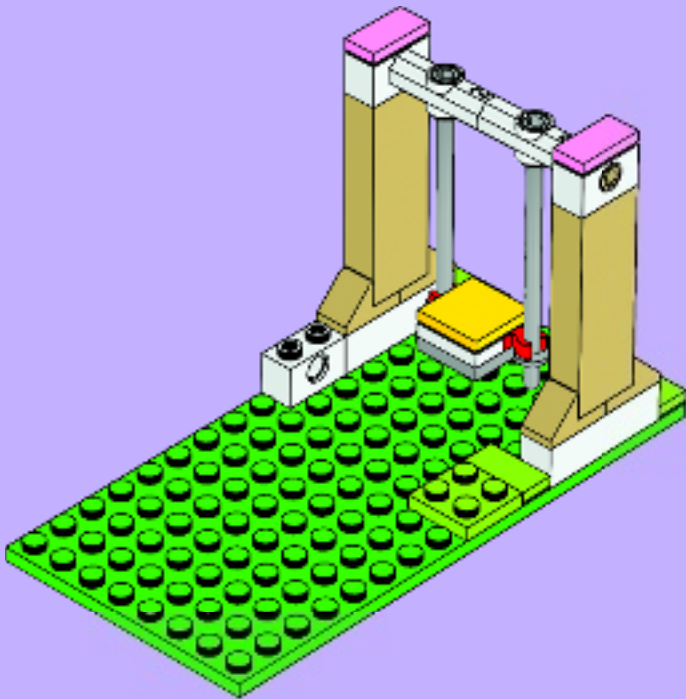

8

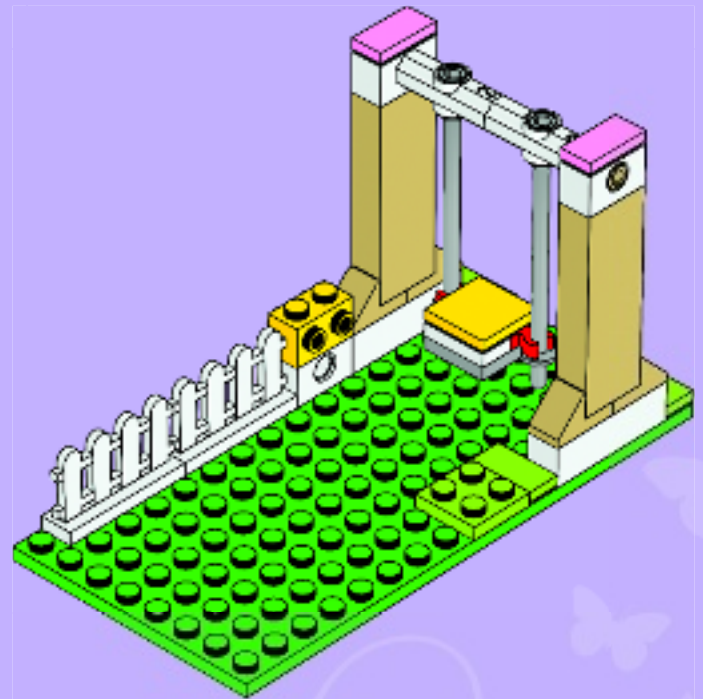





9

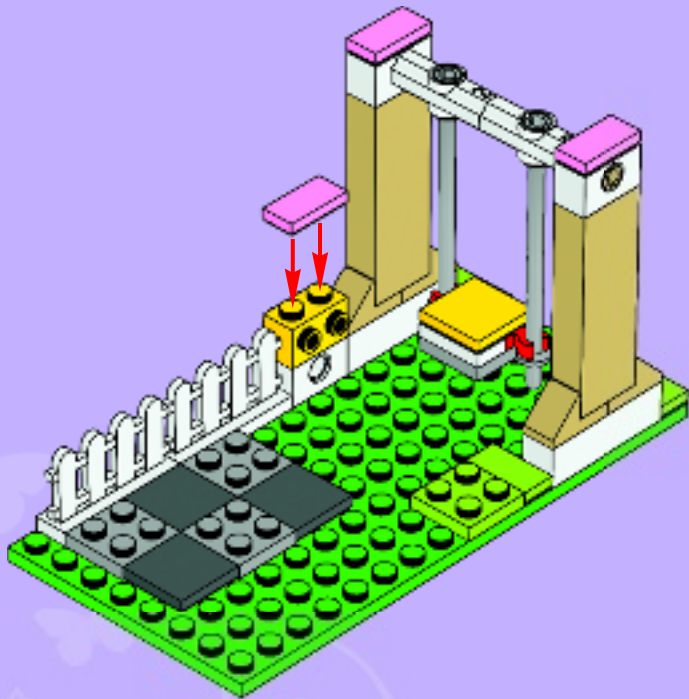

10

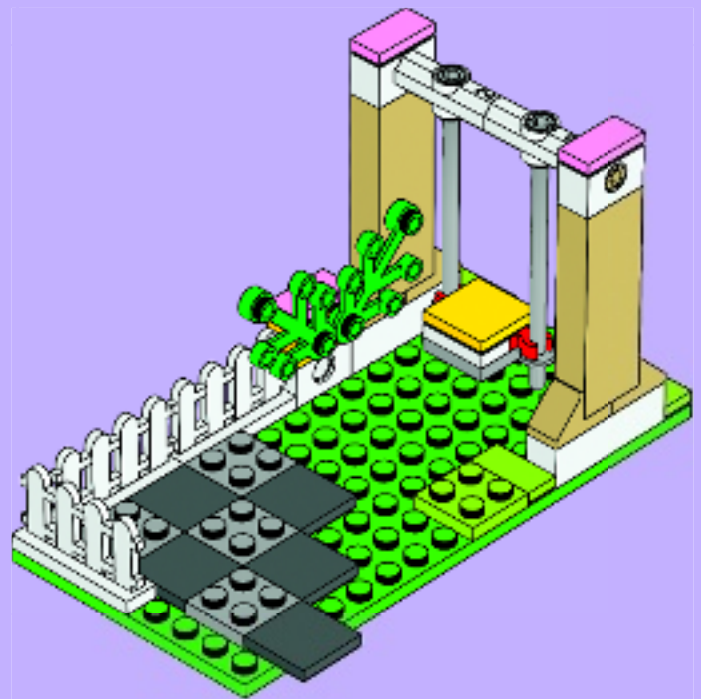

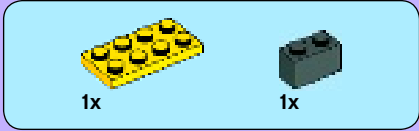

1

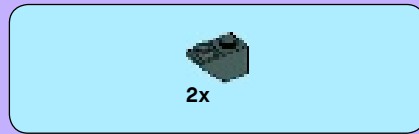
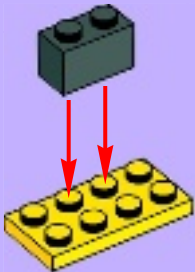

2

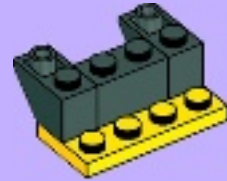

3



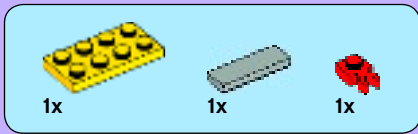

4

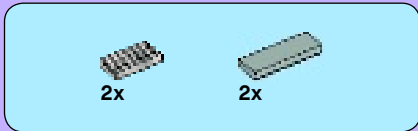

5

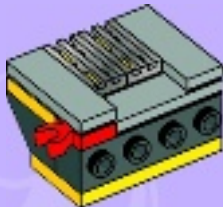

6



7

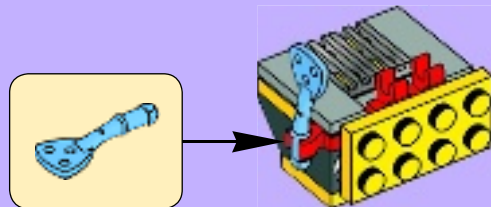



8

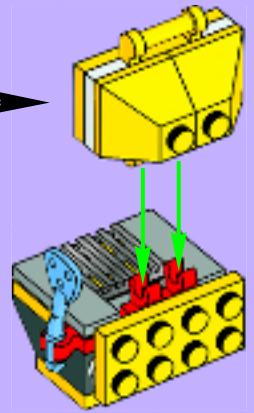

11

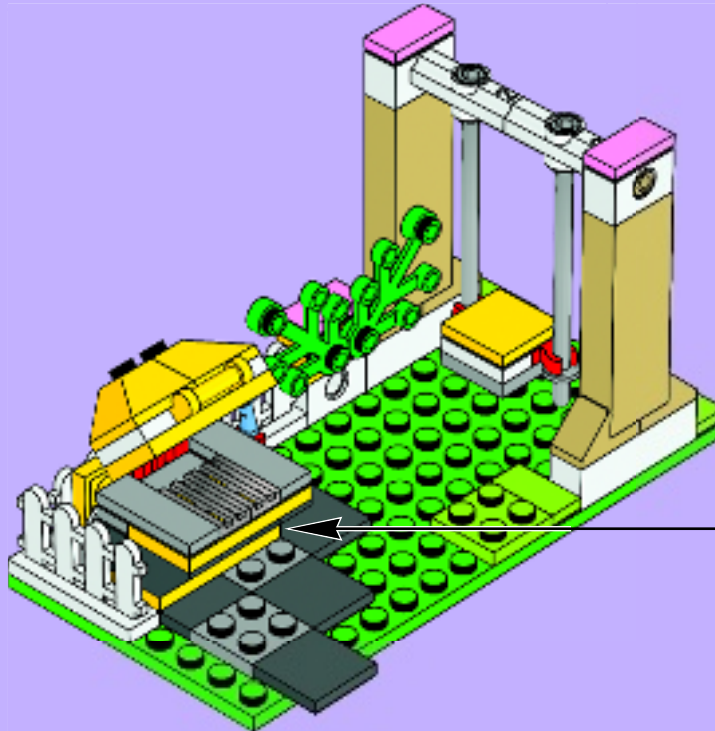

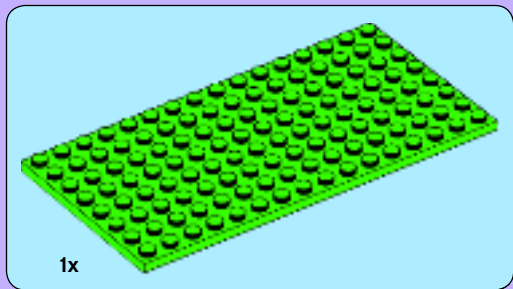

12



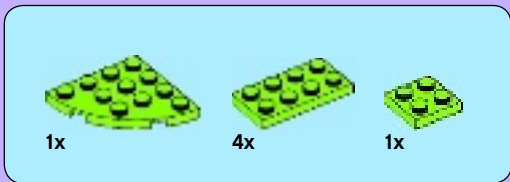

13

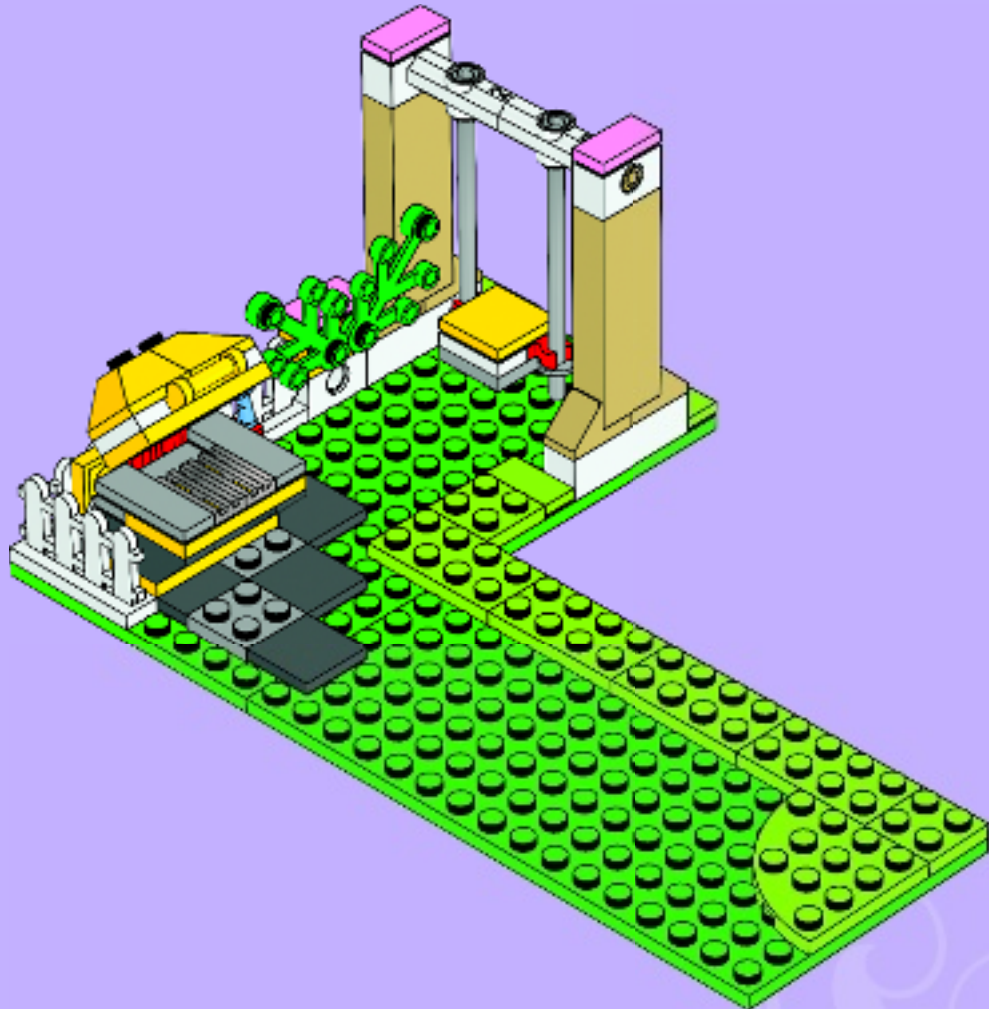





1x



1x

# 14

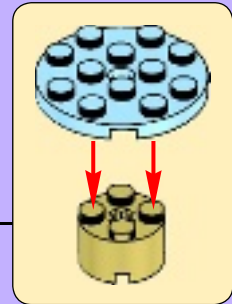

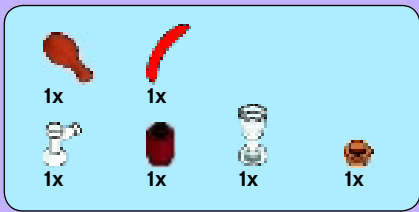

# 15

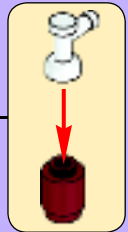
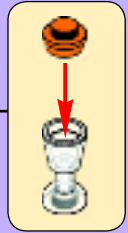
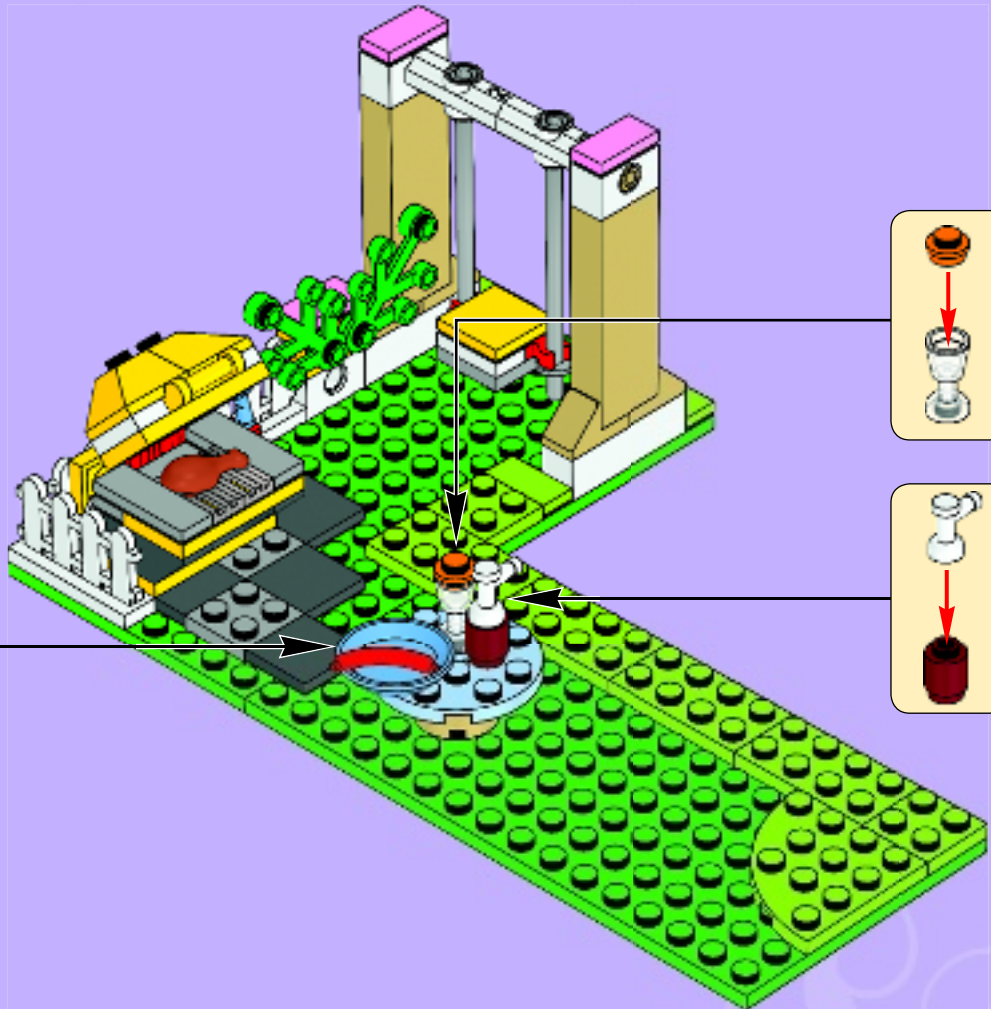

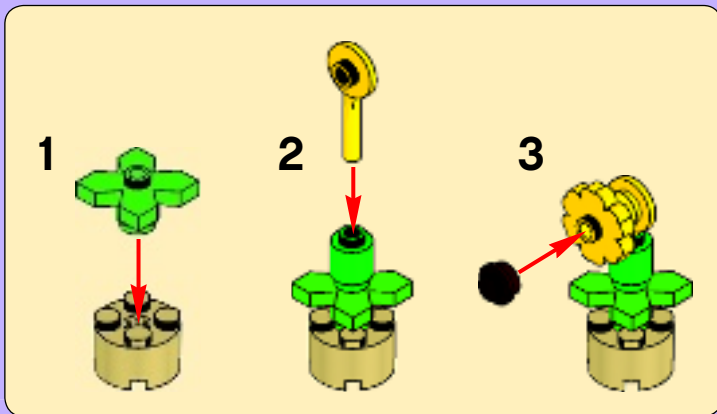

16

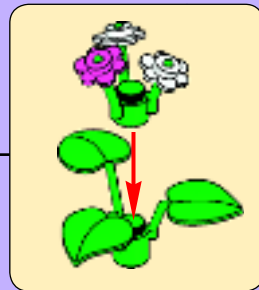



1



2



3



4

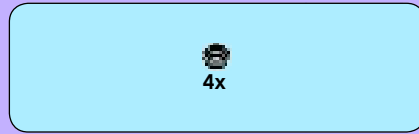
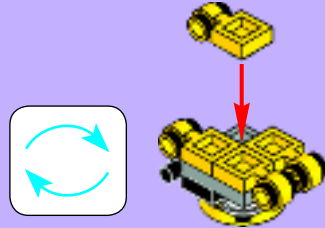

5



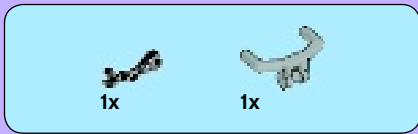

6

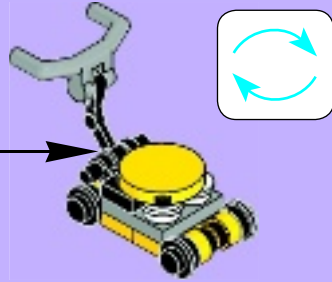
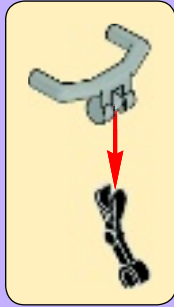

17









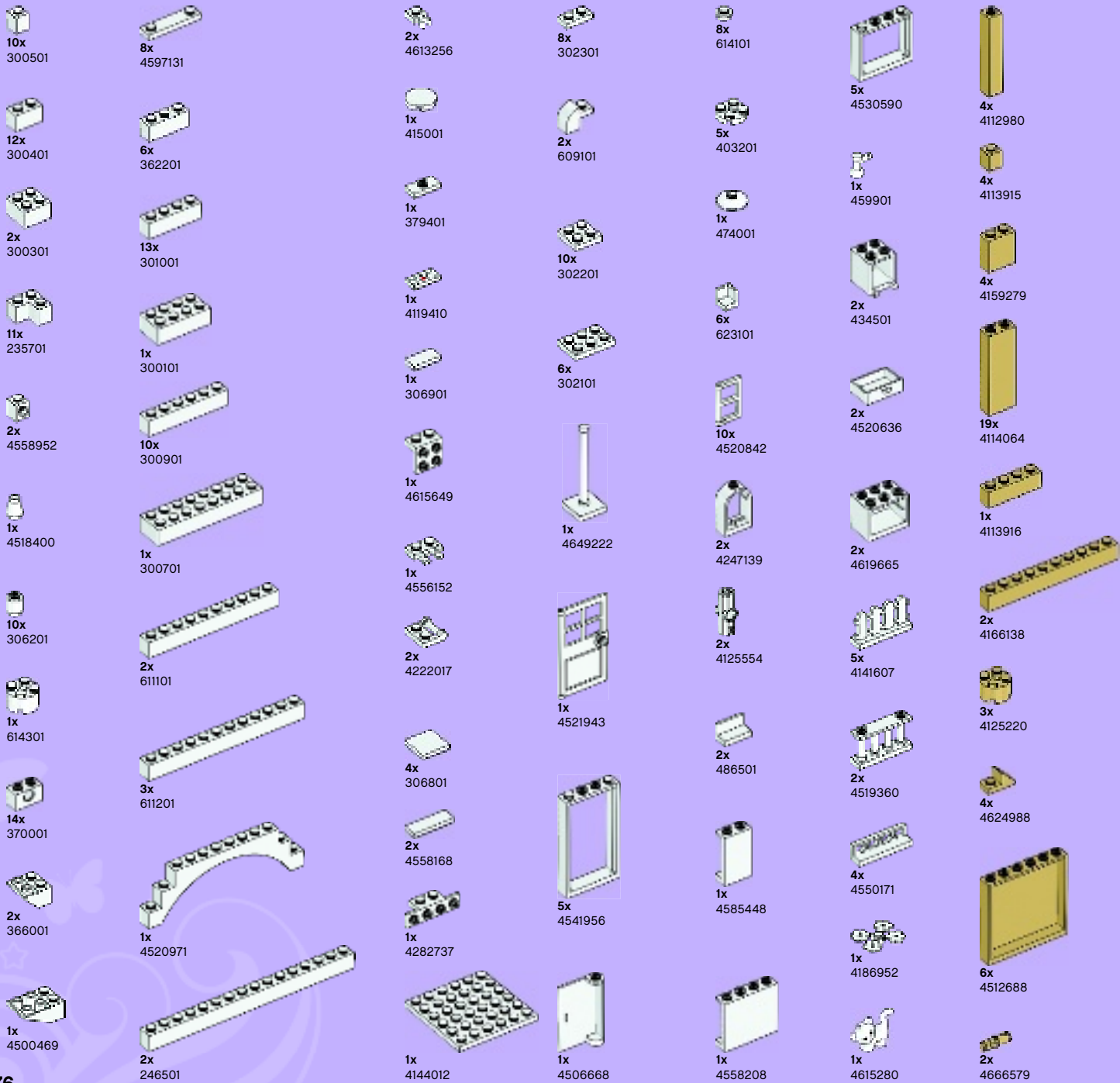



1x  
4521852



3x  
4588003



2x  
4534648



1x  
4521851

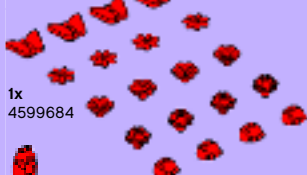

1x  
4599684



1x  
4622875



1x  
4114585



1x  
4520952



1x  
4142865



3x  
300524



2x  
300424



2x  
300324



3x  
614124



1x  
472824



1x  
4557157



2x  
4271076



4x  
302024



1x  
4243817



1x  
379524



4x  
4164060



2x  
415024



4x  
4632569



1x  
379424



2x  
4501232



1x  
306824



1x  
244424



2x  
243124



1x  
4656811



2x  
4121715



1x  
4529236



1x  
654126



1x  
4565323

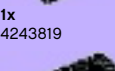

1x  
4243819

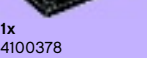

1x  
4100378



1x  
4140588



1x  
4258354



3x  
243126



8x  
614126



1x  
4278359



1x  
459926



1x  
4596244



1x  
4596244



1x  
4223247



2x  
368026



1x  
306228



4x  
374128



2x  
242328



2x  
4106895



5x  
4619599



1x  
4143562



1x  
4107432



1x  
4107050



2x  
4119479



1x  
4278013



1x  
4113949



2x  
3005740



21x  
4164021



7x  
4183133



2x  
4504705



2x  
4625625



1x  
4625623



2x  
4164022



1x  
4220632



3x  
4165967



4x  
4212454



6x  
4537937



12x  
4537936



2x  
4210212



3x  
4541957



10x  
4500125



2x  
4639698



1x  
4219773



1x  
3000240



1x  
4619596



1x  
4565363



2x  
4179828



1x  
4617013



2x  
4168345



10x  
4528357



1x  
4625280



1x  
4157103



2x  
4119478



1x  
4599053



1x  
4539099



1x  
4243668

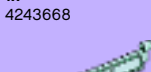

4x  
4258476



2x  
4119482



2x  
4567332



7x  
3005744



1x  
4625280



3x  
4611415



1x  
4243784



3x  
4625626



5x  
4599547



5x  
4518889



13x  
4599548



2x  
4625630



1x  
4622176



2x  
4567340



1x  
4211166



2x  
4221744



8x  
4211190



4x  
4219726



1x  
4216581



1x  
4622483



1x  
4596241



2x  
4540203



2x  
4211386



2x  
4225532



5x  
4211383



1x  
4211445



1x  
4243797



3x  
4211412



1x  
4211350



2x  
4211414



3x  
4558169



3x  
4211356

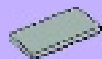

1x  
4560183



3x  
4211525



3x  
4211475



2x  
4211512



2x  
4211503



1x  
4644102



2x  
4211859



1x  
4211407



10x  
4211397



1x  
4518892



2x  
4599538



7x  
4517995



1x  
4599830



2x  
4625633

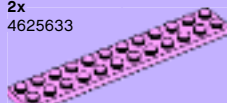

1x  
4625631



6x  
4580010



12x  
4517996



3x  
4599534



8x  
4216479



1x  
4216375



1x  
6011423



1x  
6011436



1x  
6011443



1x  
4622827



1x  
4612370



1x  
4622873



2x  
4249040



1x  
4249039



2x  
4625629



2x  
4618658



2x  
4624705



1x  
4211088



1x  
4210725



2x  
4211096



9x  
4211055

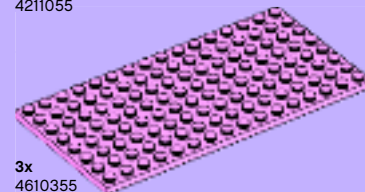

3x  
4610355

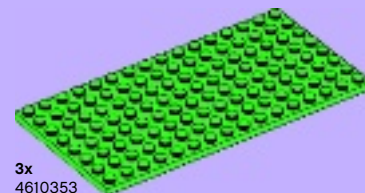

3x  
4610353



1x  
4611414



1x  
4618526



1x  
4612374



1x  
4599545



1x  
4622046



4x  
4625616



8x  
4618659



1x  
4621993



Customer Service

Kundenservice

Service Consommateurs

Servicio Al Consumidor

[www.lego.com/service](http://www.lego.com/service) or dial



00800 5346 5555 :

1-800-422-5346 :







# Friends

LEGOFriends.com



Emma



Olivia



Stephanie



Mia



Andrea



# Heartlake City



**LEGO** Friends





3183



3061



3065



3931



3187



3935



3932



3930



3933



3936



3934



3942



3188



3315





# CREATOR



5766



5771



5770



**LEGO club**  
FREE! GRATIS! GRATUIT!



www.LEGOclub.com



LEGO Club Magazine



LEGO Club Email

VISIT THE WORLD'S  
BIGGEST LEGO® SHOP!

www.LEGOshop.com

00800 5346 5555

1-866-534-6258 • 1-877-518-5346

US & Canada only

Outside the US only



- \* Freephone. Mobile charges may apply.
- \* Numéro sans frais. Des frais peuvent s'appliquer avec les téléphones cellulaires.
- \* Gebührenfrei, Kosten für Anrufe aus Mobilfunknetzen können abweichen.
- \* Gratis telefonnummer vanaf vaste lijn.
- \* Det er et gratis nummer, når du ringer fra fasttelefon.
- \* Det är gratis, när du ringer från en fast telefon.
- \* Numéro sans frais. Des frais peuvent s'appliquer avec les téléphones portables.

BI115

**YES!** I want to join the LEGO® Club FREE! **OUI!** Je veux m'abonner au LEGO® Club GRATUITEMENT !

**Ja!** Ich möchte Mitglied im kostenlosen LEGO® Club werden. **Ja!** Ik wil graag GRATIS lid worden van de LEGO® Club. **Ja!** Jeg ønsker å melde meg inn i LEGO® Club gratis! **Ja!** Jag vill gå med i LEGO® Club GRATIS!

First name • Prénom  
Vorname • Voornaam  
Fornavn • Förnamn

Last name • Nom de famille  
Name • Achternaam  
Etternavn • Efternamn

Date of Birth • Date de naissance  
Geburtsdag • Geboortedatum  
Fødselsdato • Födelsedatum

Street • Adresse  
Straße, Hausnr.  
Straat, huisnr. • Adress

City • Ville  
Ort • Woonplaats  
Poststed • Postort

Zip/Postcode  
Code Postal • PLZ  
Postcode  
Postnummer

Email • Courriel  
E-Mail • E-post

Boy • Garçon  
Junge • Jongen  
Gutt • Pojk

Girl • Fille  
Mädchen • Meisje  
Jente • Flicka

State  
Prov. / County

Country  
Pays  
Land

- Fill in your email address and we will send you a membership confirmation and monthly email newsletters. If you do not wish to receive the newsletters please tick here. Remplis ton adresse e-mail et nous t'enverrons une confirmation d'adhésion ainsi que le bulletin e-mail mensuel. Si tu ne désires pas recevoir le bulletin, coche cette case. Vul je e-mailadres in en we sturen je een bevestiging van je lidmaatschap en maandelijke e-mail nieuwsbrieven. Als je geen e-mail wilt ontvangen, kruis dan dit vakje aan.
- Ich möchte per E-Mail den monatlichen LEGO Club Newsletter erhalten. Ønsker du at vi skal sende en liten hilsen til barnet ditt for å bekrefte medlemskapet, ber vi deg krysse av i feltet, samt oppgi e-postadressen som hilsen skal sendes til. Om du vill att vi ska skicka en bekräftelse på ditt barns medlemskap, ber vi dig sätta ett kryss i rutan och skriva den e-post adress som bekräftelsen ska skickas till.
- If you do not wish to receive additional mailings from the LEGO Club please tick here. Si tu ne désires pas recevoir de courrier supplémentaire du Club LEGO, coche cette case. Als je geen verdere post van de LEGO Club wilt ontvangen, kruis dan dit vakje aan.
- Dersom du ønsker å motta annen informasjon fra LEGO Gruppen, setter du et kryss her.

Mail to: / Poster à:



LEGO® Club  
P.O. Box 1157  
Enfield, CT USA  
06083-1157

Per Post an:



LEGO® Club  
Postfach 14 15  
D-36243 Niederaula

Send til:



LEGO® Club Norge  
Postboks 58  
1314 Vøyenenga

Mail to:



LEGO® Club  
33 Bath Road  
Slough SL1 3UF  
United Kingdom

Stuur na naar:



LEGO® Club  
Postbus 40250  
3504 AB Utrecht

Skickas till:



LEGO® Club Sverige  
Ubox 841  
202 29 Malmö

Poster à:



LEGO® Club  
21 rue de la banque  
75 002 PARIS  
FRANCE

The English language version of the magazine can only be mailed to addresses in the US, Canada, the UK, and Republic of Ireland. Club membership is valid for two years and includes free copies of the LEGO Club Magazine and e-mail newsletters. In the US and Canada please allow up to 6 weeks for delivery of your first magazine. In the UK and Republic of Ireland please allow six to 14 weeks for delivery of your first magazine. By signing this form you consent the LEGO Club to use your child's data for LEGO mailings. The data will only be used for LEGO mailings and will not be sold, rented or otherwise disclosed to any company outside the LEGO Company except for disclosure to companies acting as our agents to help us provide services requested by the child. This coupon is valid for one free membership per person, group or organization. Photocopied coupons are accepted.  La version française du magazine peut être postée uniquement au Canada. L'abonnement est valide pour 2 ans et inclut des exemplaires gratuits du Magazine LEGO. Aux É.U. et au Canada, attendre 6 semaines pour la livraison initiale. En remplissant ce formulaire, vous consentez à ce que LEGO utilise les informations de votre enfant pour des envois de postaux de LEGO. L'information sera utilisée uniquement pour des envois de postaux par LEGO et ne sera en aucun cas, vendue, louée, échangée ou divulguée à d'autres compagnies autres que la compagnie LEGO, à l'exception des compagnies affiliées qui nous procurent des services auxquels l'enfant en a fait la demande. Formulaires photocopiés acceptés.  Mit der folgenden Unterschrift erkläre ich, für mein Kind den Beitritt als Mitglied zum kostenlosen LEGO Club, der von der LEGO GmbH, D-85627 Gräfelfing, betrieben wird. Die Mitgliedschaft beinhaltet die Zusendung des LEGO Club Magazines und kann beiderseits jederzeit beendet werden. Mit der Mitgliedschaft im LEGO Club sind keinerlei Verpflichtungen verbunden. Das deutschsprachige LEGO Club Magazin wird nur an Adressen in Deutschland, Österreich und der Schweiz versendet. Eine Anmeldebestätigung kann nur per E-Mail geschickt werden. Das Magazin erscheint fünfmal jährlich. Daher kann die Zustellung des ersten Heftes bis zu drei Monate dauern. Die Mitgliedschaft ist beidseitig jederzeit kündbar, ohne dass Ihnen Kosten entstehen. Sie können der werblichen Nutzung Ihrer Daten jederzeit widersprechen. Kündigung und Widerspruch können Sie telefonisch erklären (00800 / 5346 5555, Anruf gebührenfrei, Kosten für Anrufe aus dem Mobilfunknetz können abweichen) oder an die LEGO GmbH senden.  Het Nederlandse LEGO Club Magazine kan alleen worden gestuurd naar adressen in Nederland. Het lidmaatschap is 2 jaar geldig en geeft recht op toezending van het gratis LEGO Club Magazine en LEGO Club e-mails. Het eerste magazine zal binnen 12 tot 14 weken toegestuurd worden. Het lidmaatschap kan op ieder moment opgezegd worden en is 2 jaar gratis worden verlengd, tenzij LEGO met deze activiteit stopt. Uw gegevens worden uitsluitend gebruikt voor mailings van LEGO en zullen niet worden verkocht, verhuurd of op welke wijze dan ook verstrekt aan derden buiten de LEGO Groep, uitgezonderd de organisaties die namens ons optreden om de informatie te sturen waarvoor toestemming is verleend.  Den norske utgaven av magasinet sendes kun til adresser i Norge. Medlemskap i klubben gjelder 12 år og inkluderer gratisutgaver av LEGO Club Magazine. Prøven minimum oppliks seks uker leveringstid for første magasin. Ved å undertegne dette skjemaet, gir du ditt samtykke til at LEGO Club kan bruke opplysningene om barnet ditt i LEGO forsendelser. Dataene vil utelukkende bli brukt i LEGO forsendelser og vil ikke bli solgt, utleid eller på annen måte gjøres tilgjengelig for selskaper utenfor LEGO gruppen, unntatt selskaper som er våre agenter og som hjelper oss å tilby tjenestene barnet etterseer. Dette skjemaet gjelder for ett gratis medlemskap per person, gruppe eller organisasjon.  Den svenska versionen av tidningen kan endast skickas till adresser i Sverige. Club-medlemskapet är giltigt i 2 år och innefattar gratis exemplar av LEGO Club Magazine. Vänligen räkna med minimum 6 veckor för leverans av din första tidning. Genom att skicka in det här formuläret godkänner du att LEGO Club använder barnets uppgifter för LEGO utskick. Uppgifterna kommer bara att användas för LEGO utskick och kommer inte att säljas, hyras ut eller vidarebefordras till något företag som inte tillhör LEGO Gruppen, med undantag av företag som agerar som våra ombud för att tillhandahålla tjänster som barnet har begärt. Den här kupongen gäller för ett gratis medlemskap per person, grupp eller organisation.  En complétant ce bulletin d'adhésion, vous acceptez que LEGO Club utilise les données relatives à votre enfant pour l'envoi de courriers concernant LEGO. Ces données seront uniquement utilisées pour l'envoi d'information concernant LEGO et ne seront ni vendues, ni louées, ni utilisées par d'autres sociétés que le groupe LEGO, à l'exception des sociétés agissant pour le compte de LEGO en tant que sous-traitant de services divers. L'abonnement au LEGO Club est valable pour deux ans. Il inclut l'envoi par courrier du magazine LEGO Club et par email des newsletters. Un délai de 6 à 14 semaines est à prévoir pour la réception de votre premier magazine. Ce bulletin d'adhésion gracieux est valable pour l'inscription d'une seule personne. Les photocopies sont acceptées. ATTENTION! Le bulletin d'adhésion doit être rempli et signé par un parent ou un tuteur.

Parent's signature • Signature d'un parent ou d'un tuteur •  
Unterschrift Erziehungsberechtigter • Handtekening ouders •  
Foreldres/foresattes underskrift • Förälders/förmyndares underskrift

Date  
Datum  
Date





# Win!

Go to [www.LEGOsurvey.com/product](http://www.LEGOsurvey.com/product) to fill out a survey for a chance to win a cool LEGO® Product.

No purchase necessary.

Open to all residents where not prohibited.



## [www.LEGOsurvey.com/product](http://www.LEGOsurvey.com/product)

### Gewinne! Win!

Nimm an der Umfrage auf [www.LEGOsurvey.com/product](http://www.LEGOsurvey.com/product) teil und hab die Chance ein cooles LEGO® Produkt zu gewinnen!

Die Teilnahme am Gewinnspiel führt zu keinerlei Kaufverpflichtungen. Teilnahme in allen nicht ausgeschlossenen Ländern möglich.

Ga naar [www.LEGOsurvey.com/product](http://www.LEGOsurvey.com/product), vul een enquêteformulier in en maak kans op een cool LEGO® product.

Geen aankoopverplichting. Iedereen mag deelnemen, uitgezonderd ingezetenden van landen waar een enquêteverbod geldt.

### Gagne! 当てよう!

Visite [www.LEGOsurvey.com/product](http://www.LEGOsurvey.com/product) pour répondre à un questionnaire et avoir une chance de gagner un produit LEGO® très cool!

Aucune obligation d'achat. Ouvert à tous les résidents des pays autorisés.

[www.LEGOsurvey.com/product](http://www.LEGOsurvey.com/product) にアクセスして、アンケートにご記入ください。当選者にはレゴ®製品を差し上げます。

お買い上げの必要はありません。

禁止されていない限り、すべての皆様にご利用いただけます。