



ELVES

41177





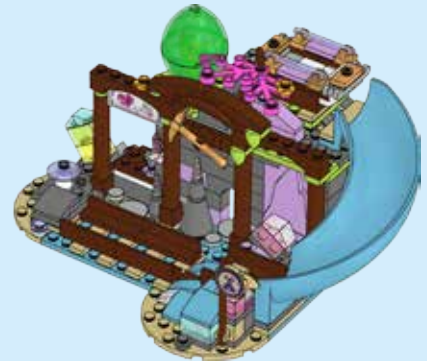
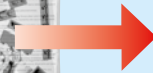
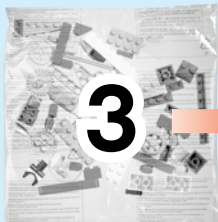
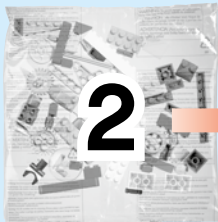

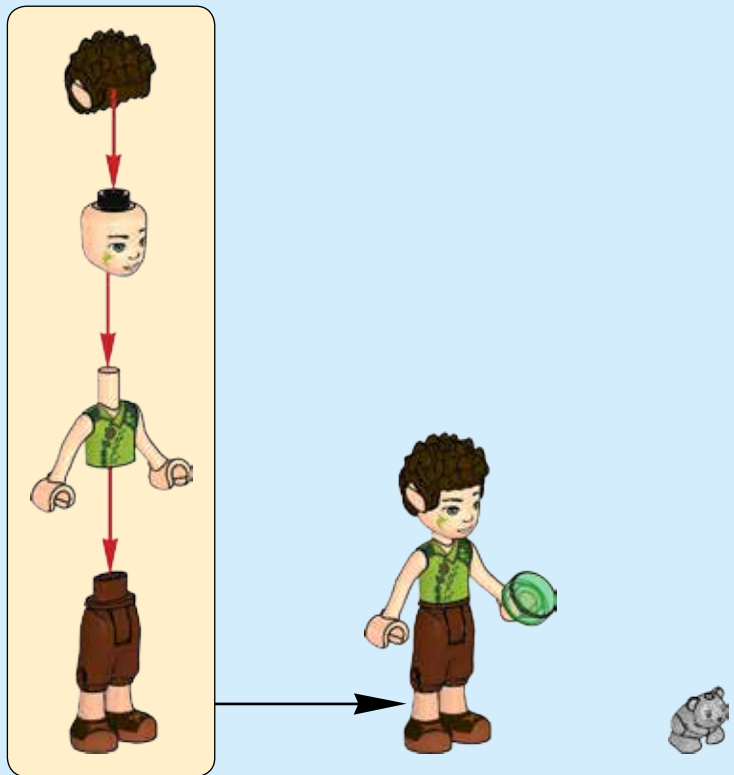
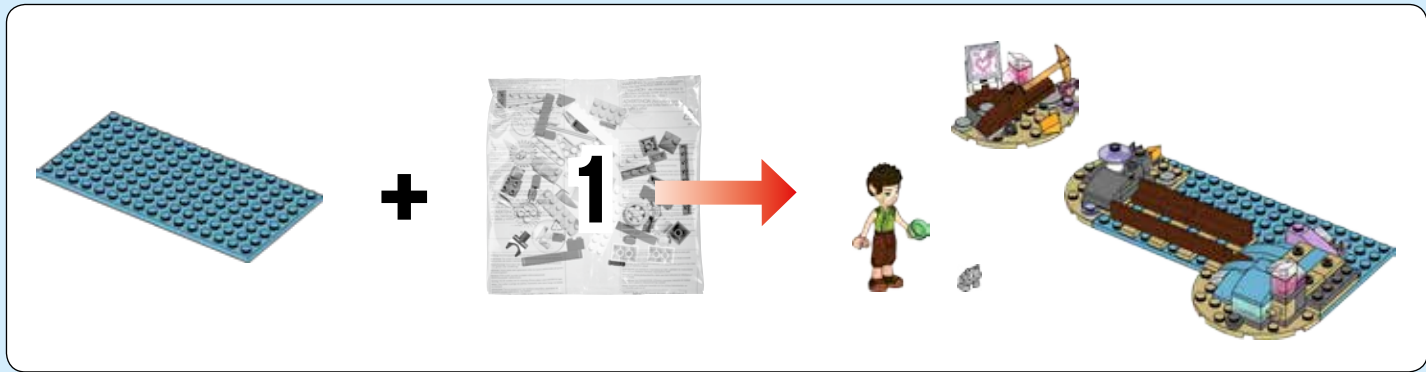

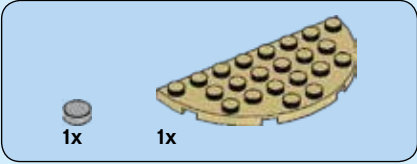

1

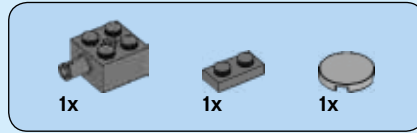
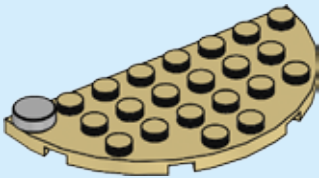

2

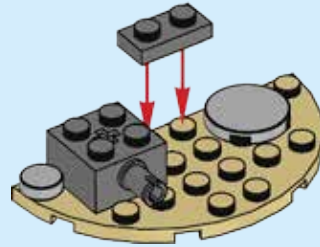

3



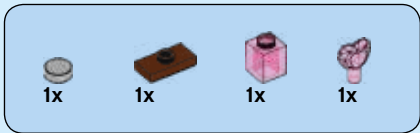

4



5

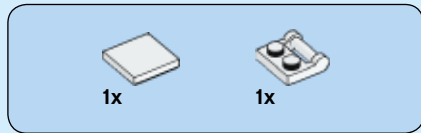

6

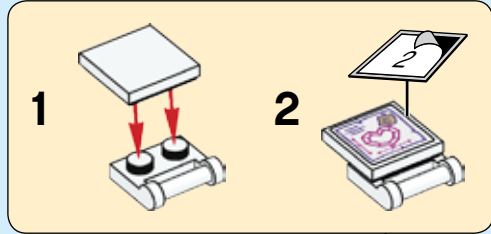

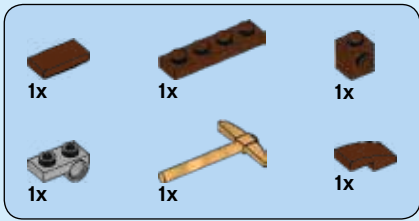

7

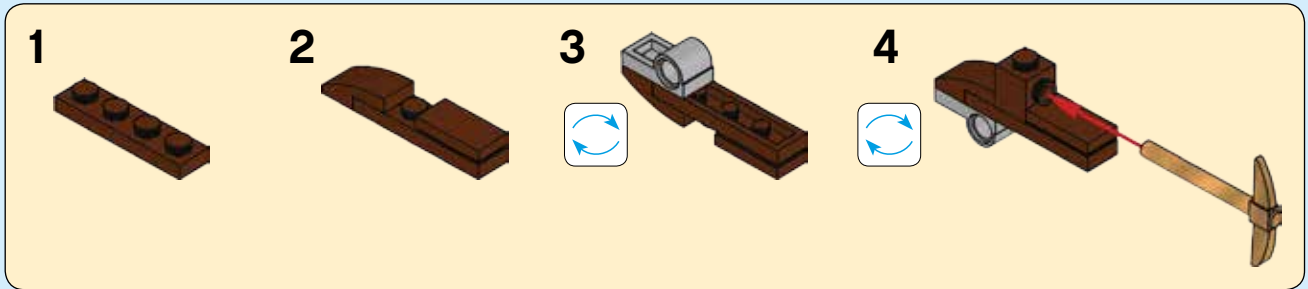

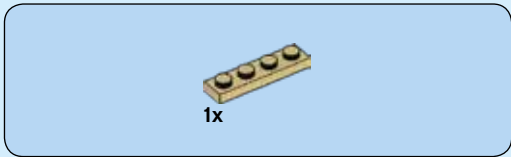
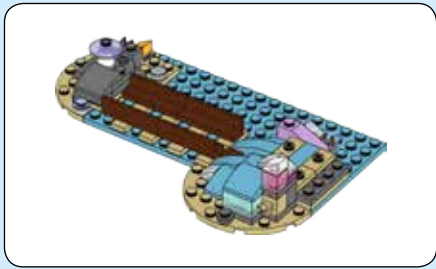

1

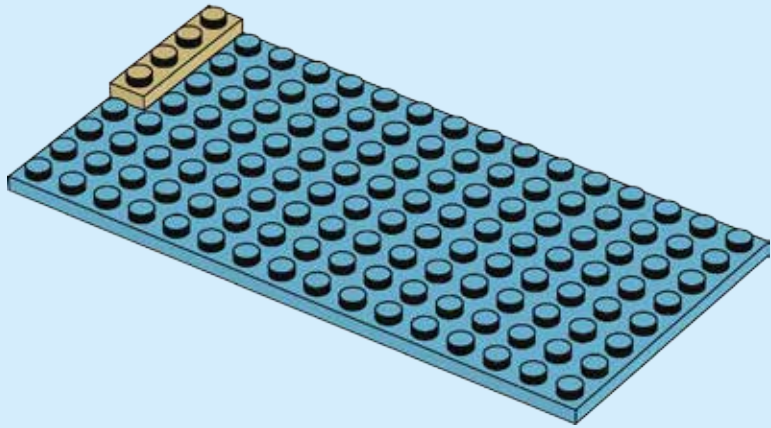

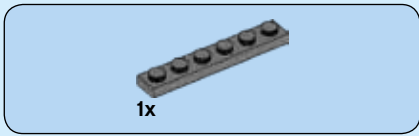

2

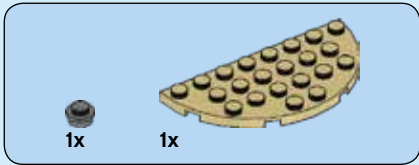
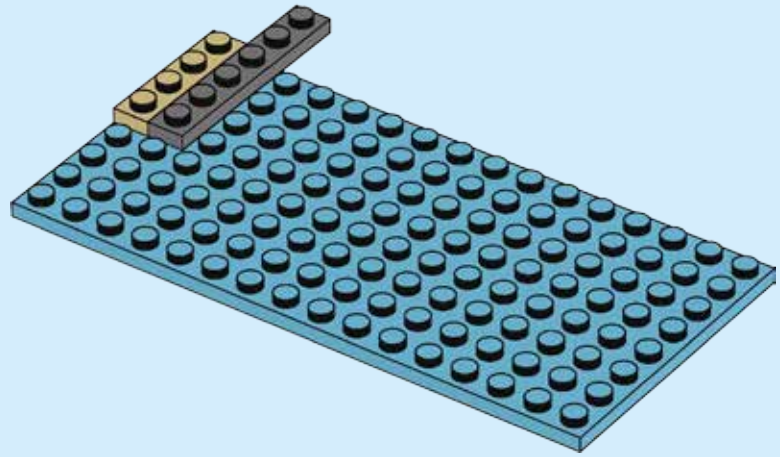

3

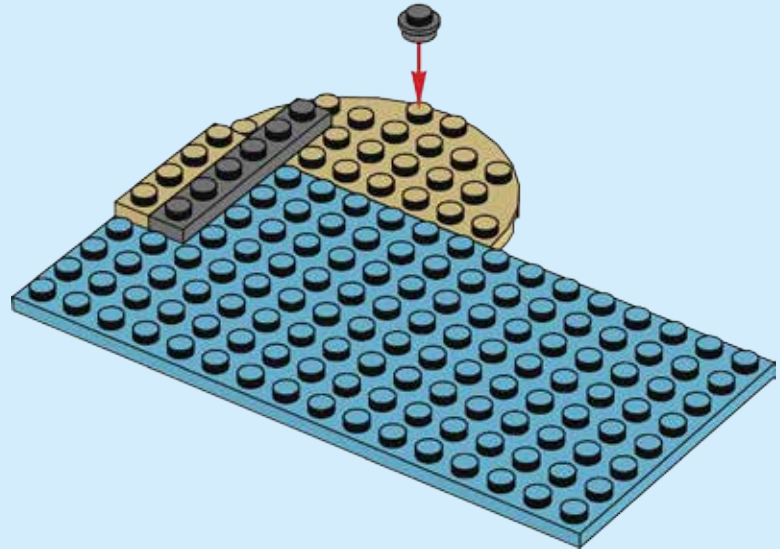

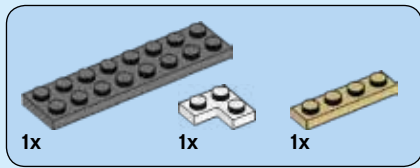

4

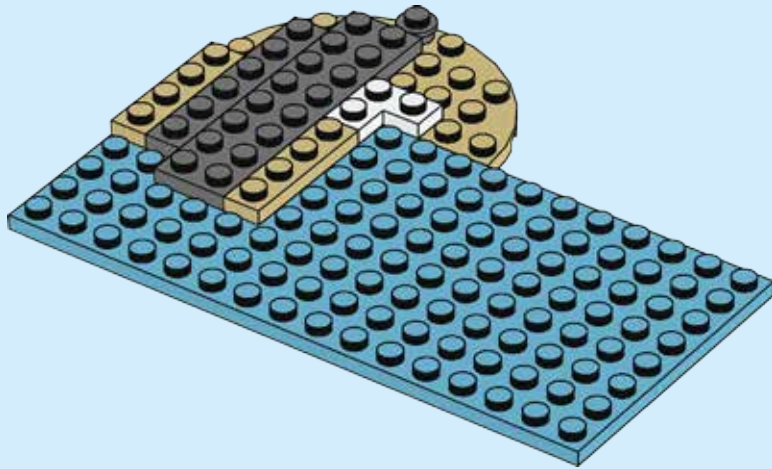



5

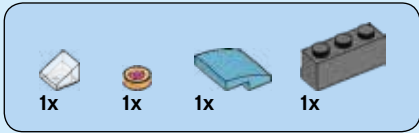
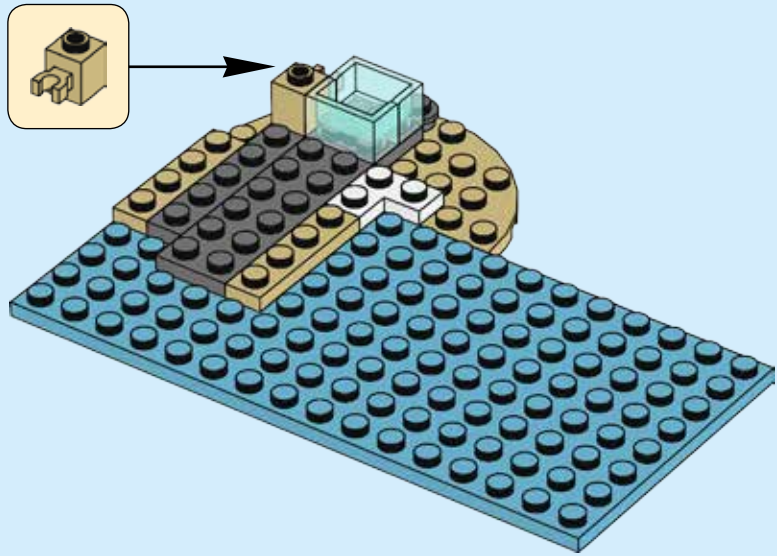

6

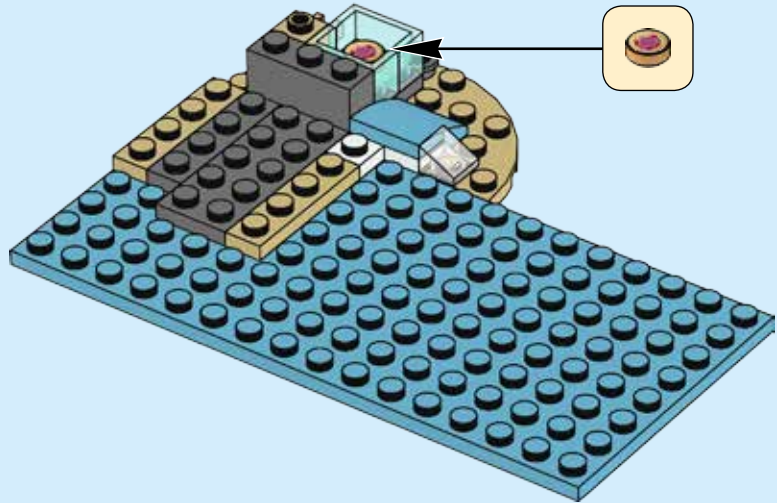

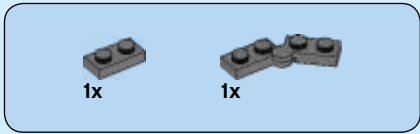

7

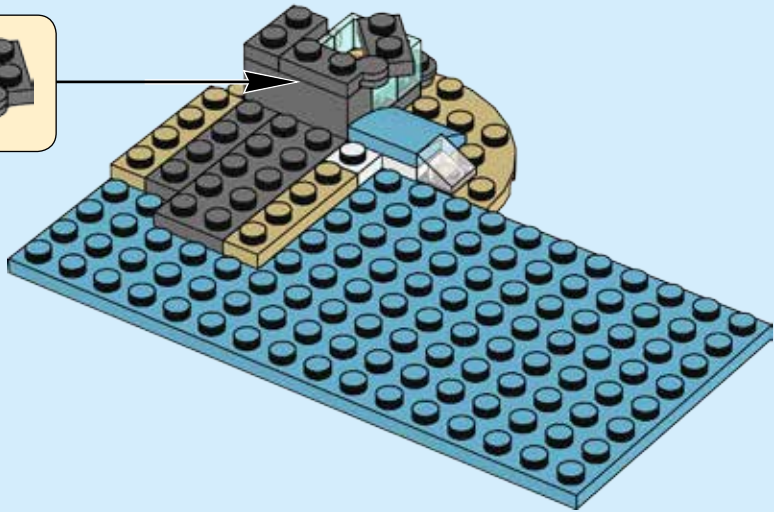

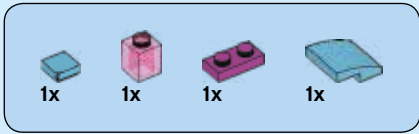

8

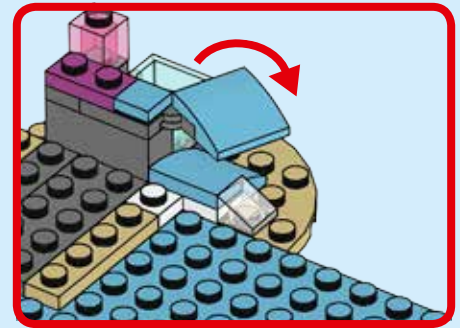
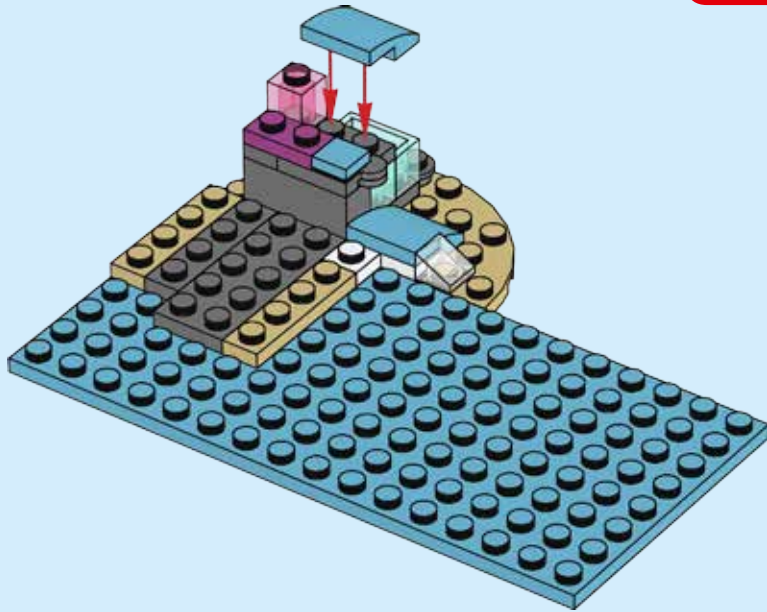

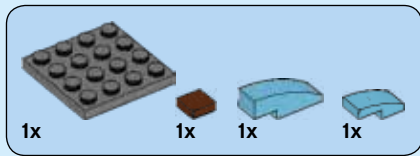

9

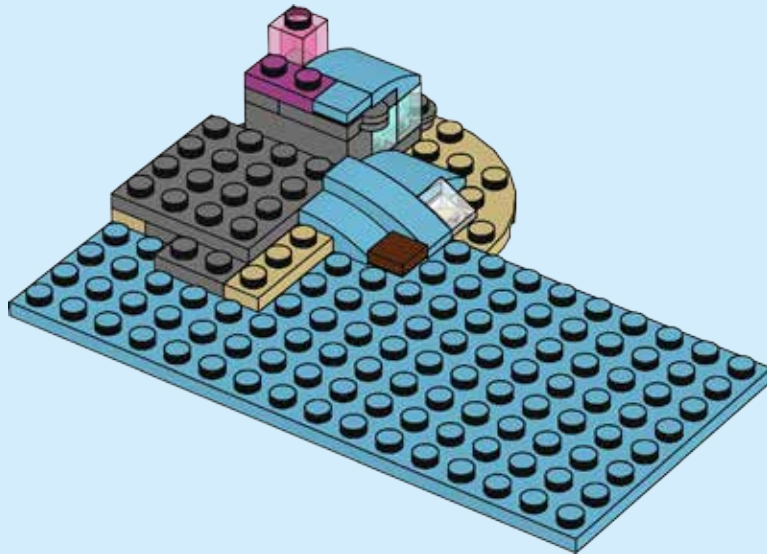

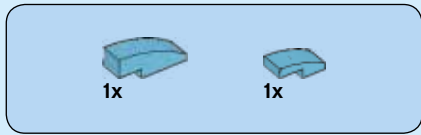

10

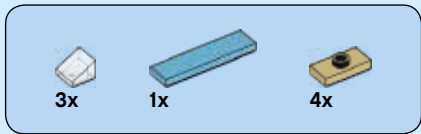
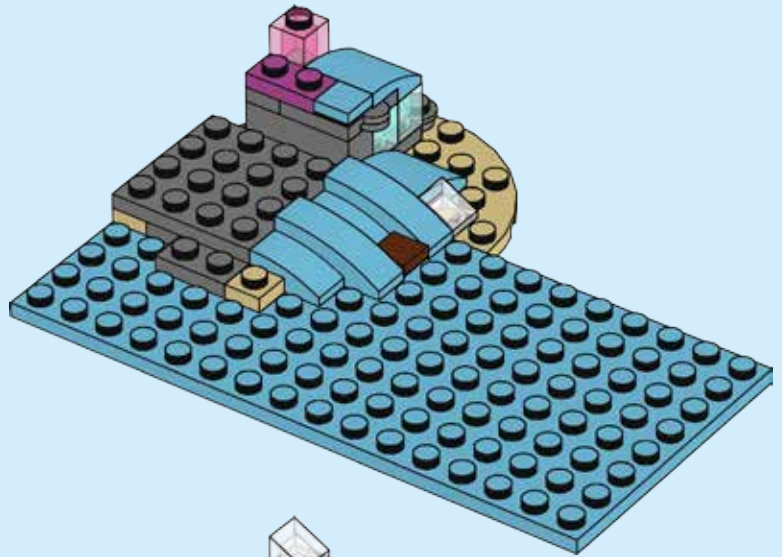

11

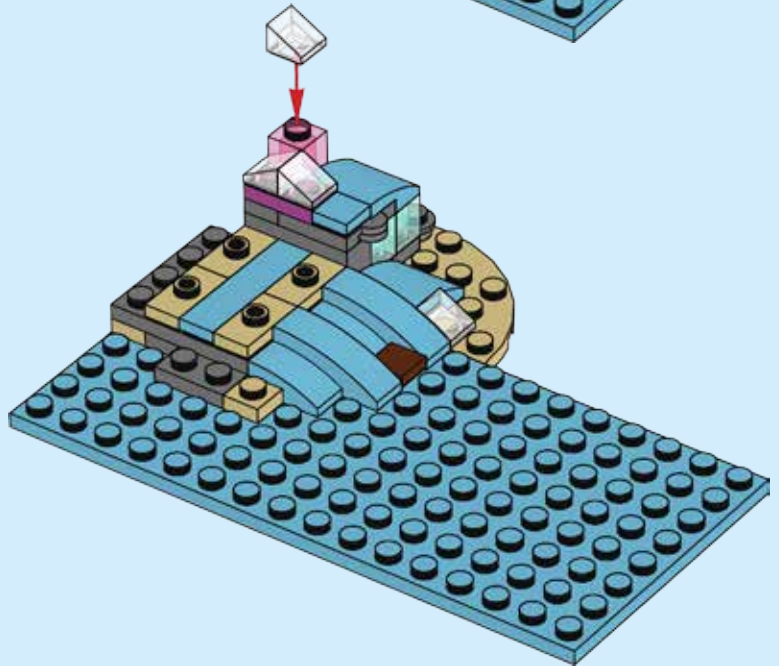



12

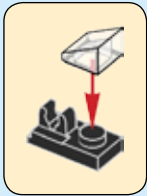
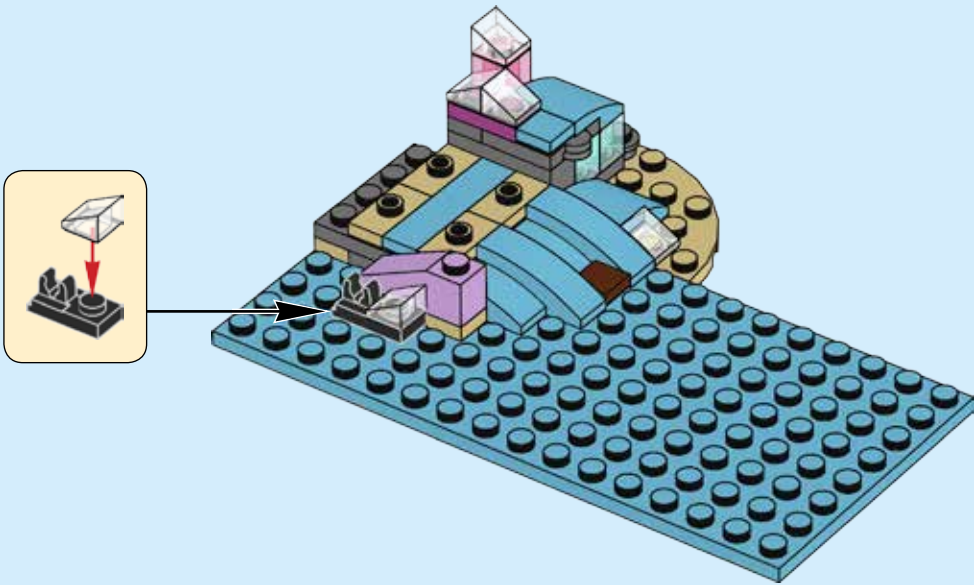



8x

13

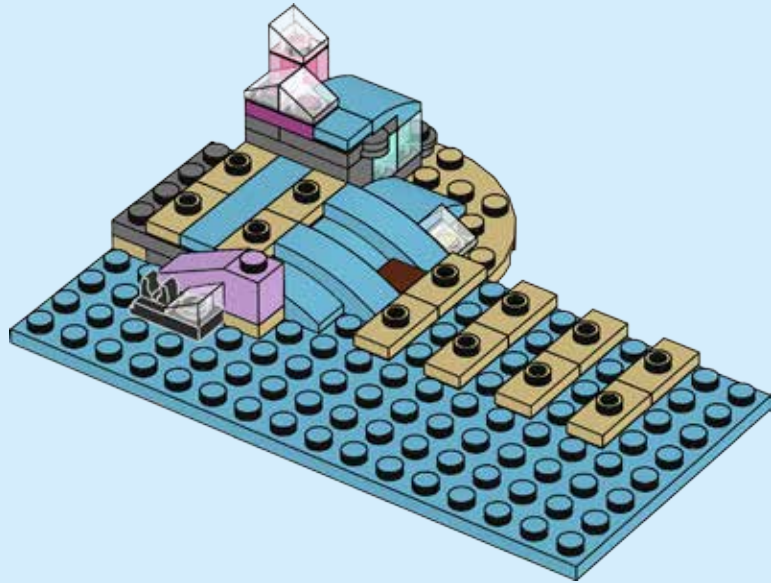

4x

14

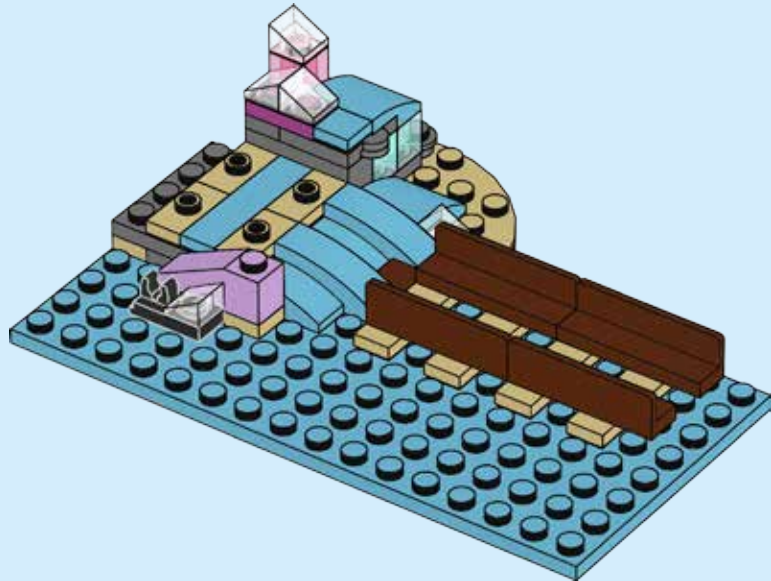

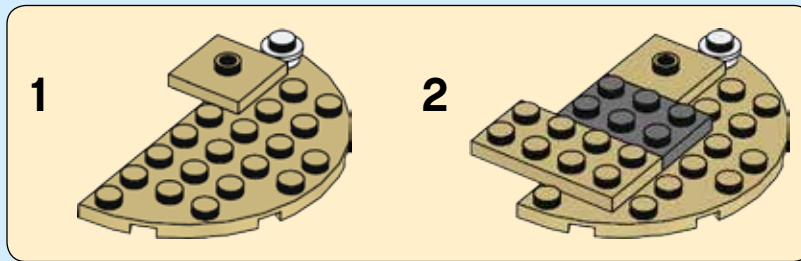
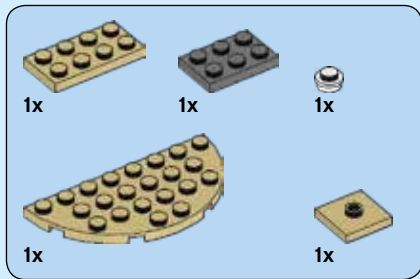

15

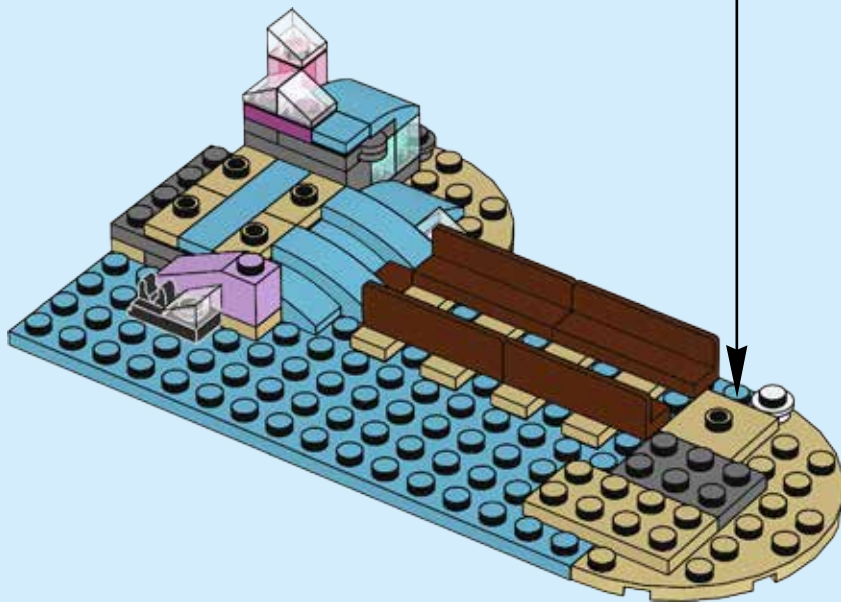

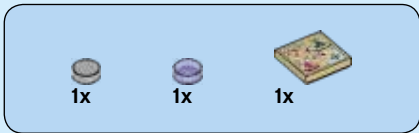

16

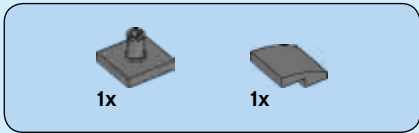
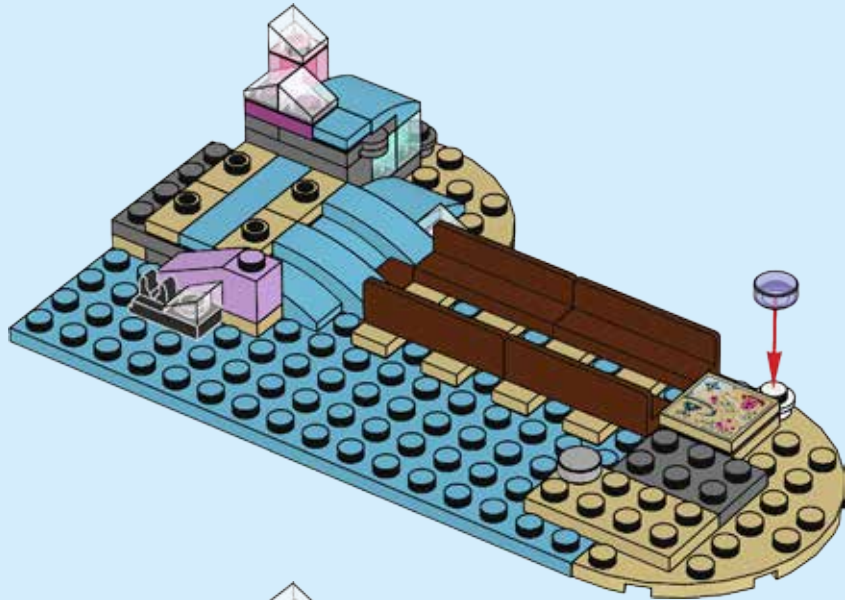

17

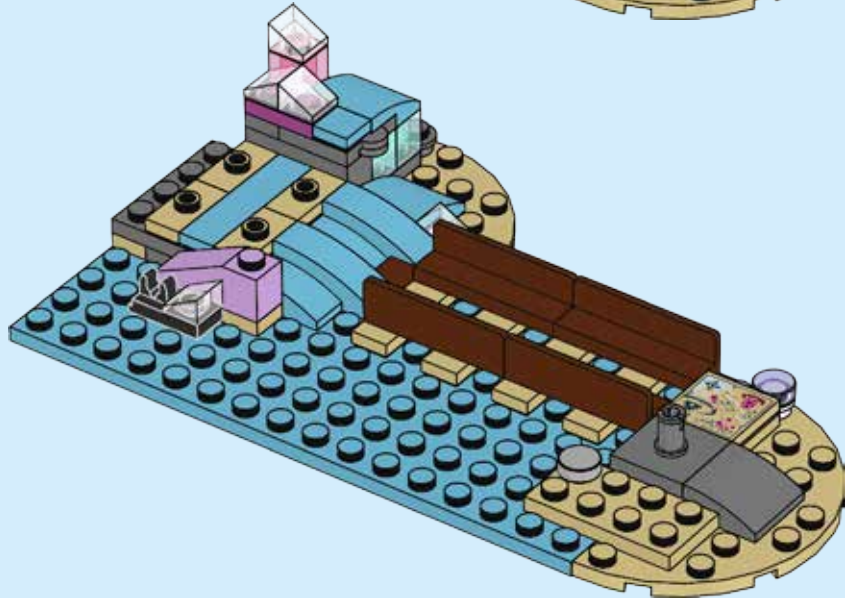



18

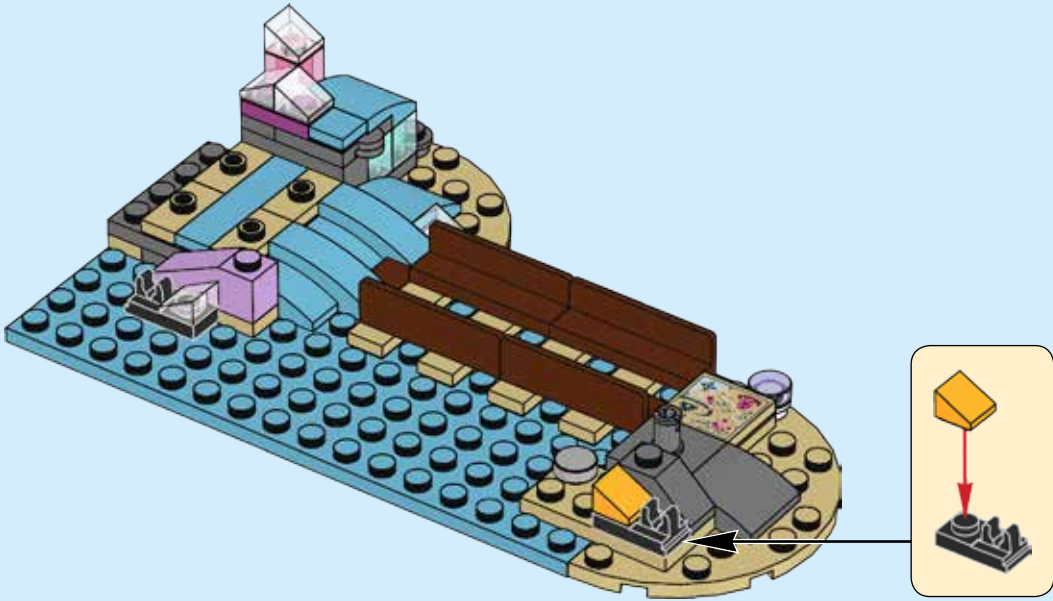

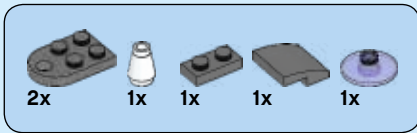

19

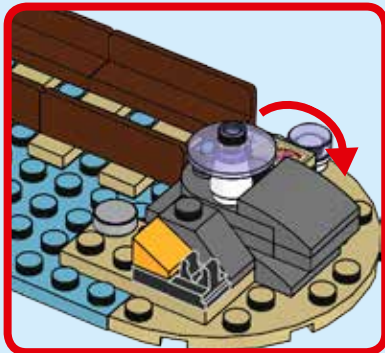
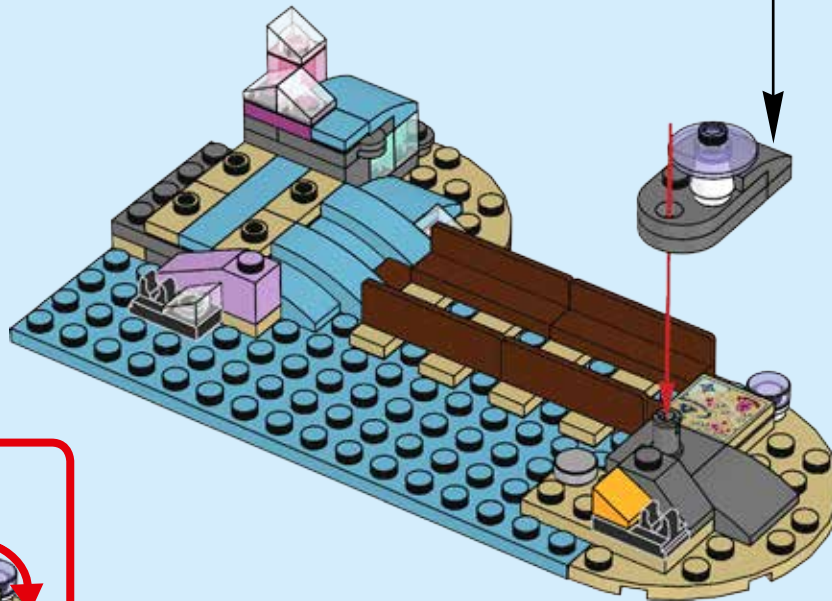
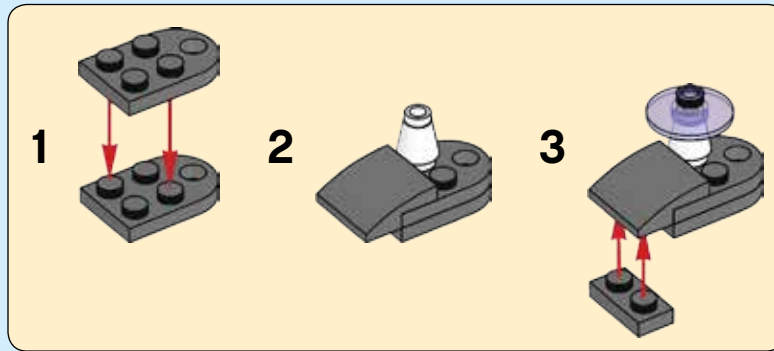

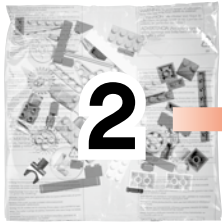

1x



1x



2x



1x

20

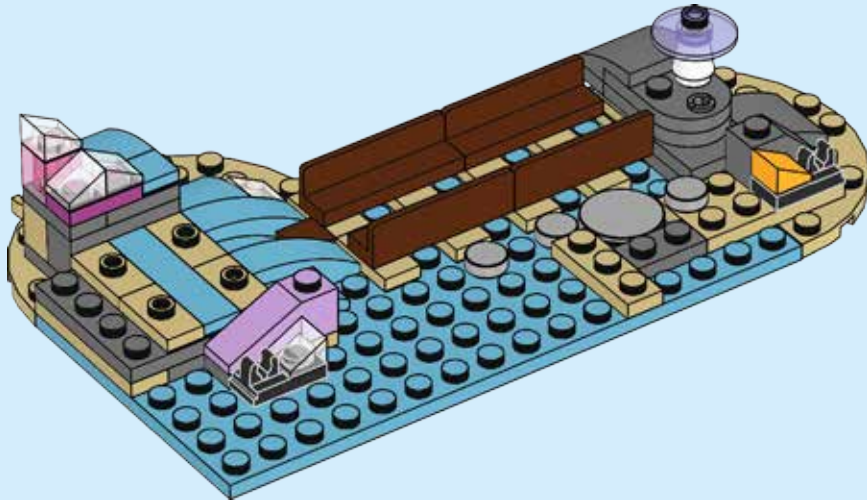

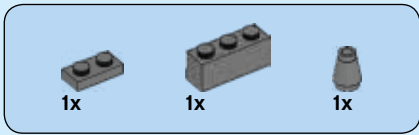

21

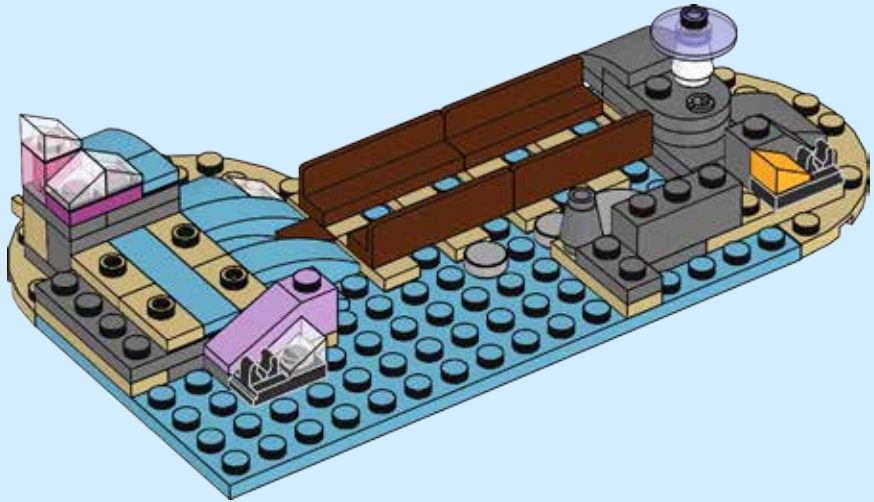

22

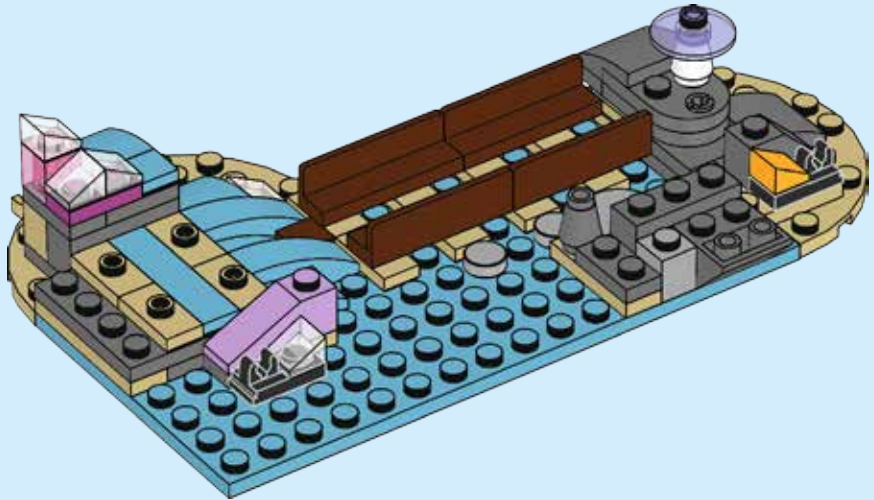



1x



1x



1x

23

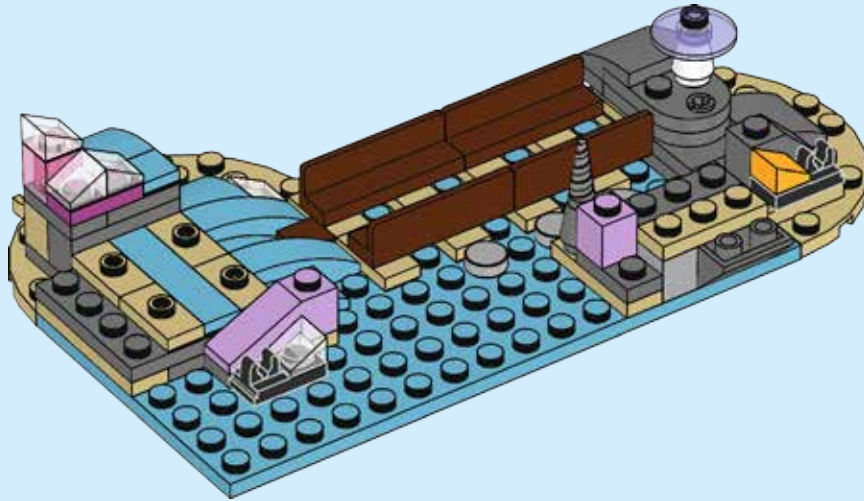

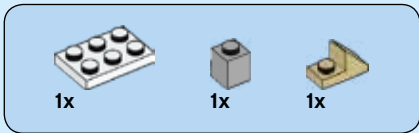

24

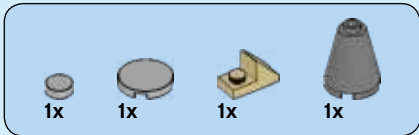
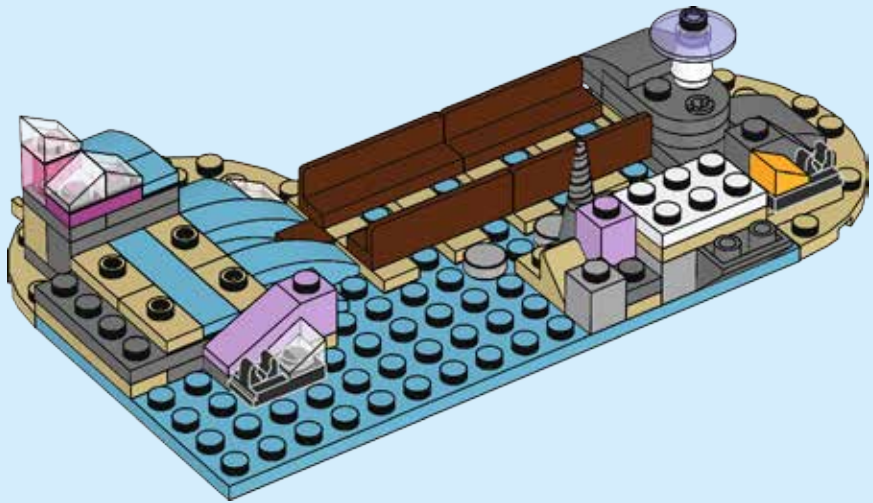

25

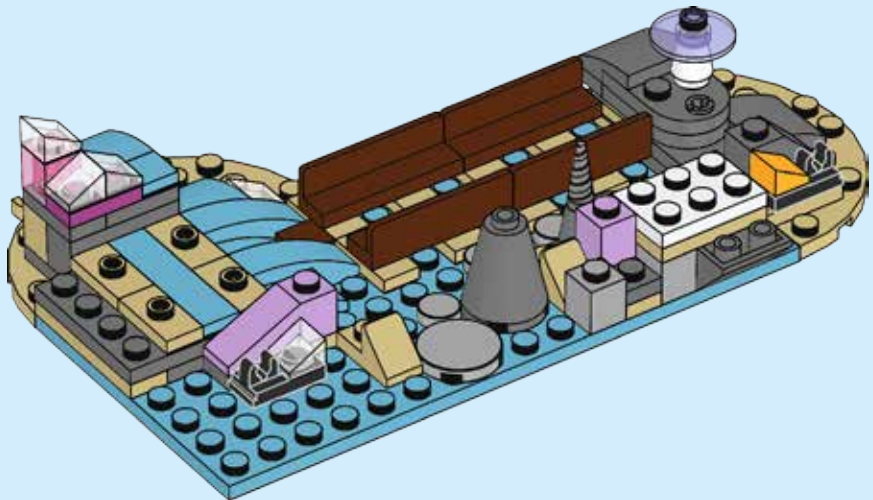



1x



1x

26

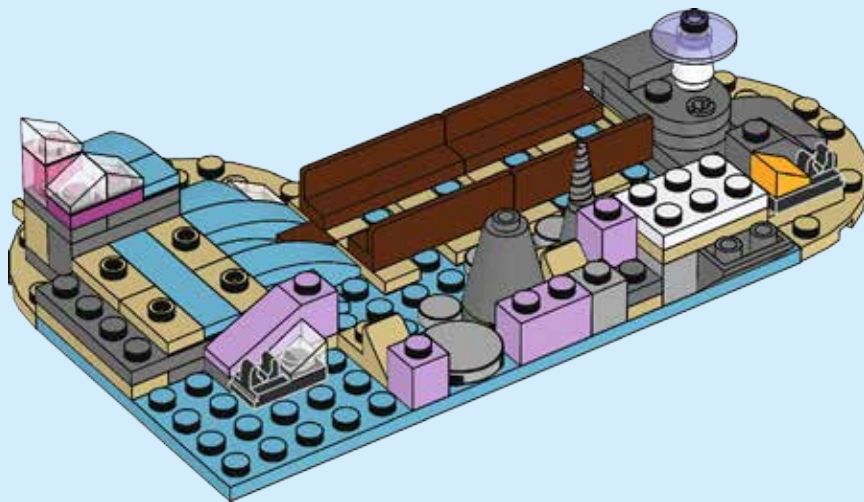



27

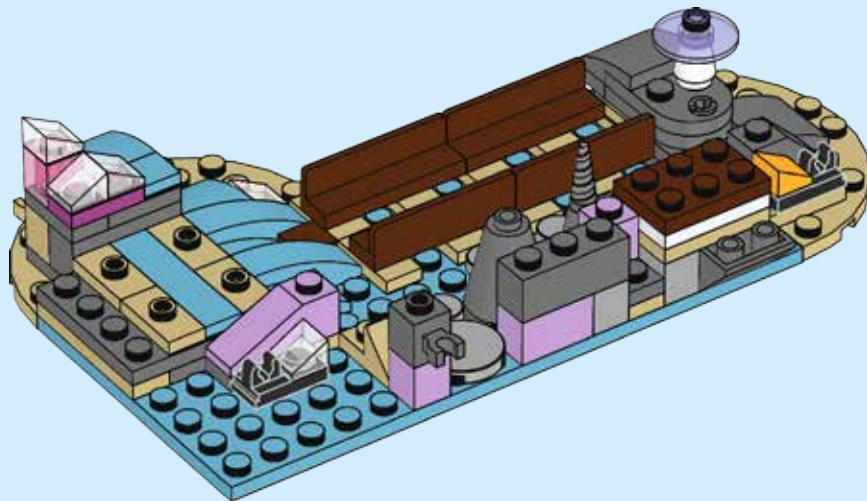

28

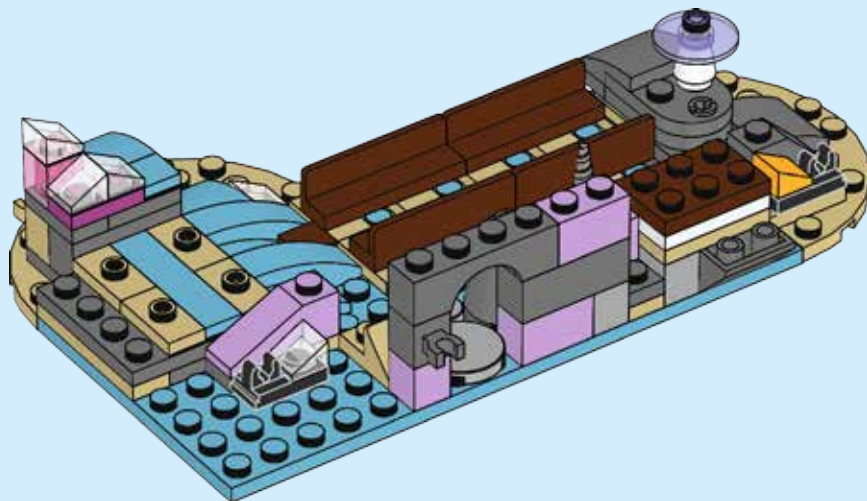



29

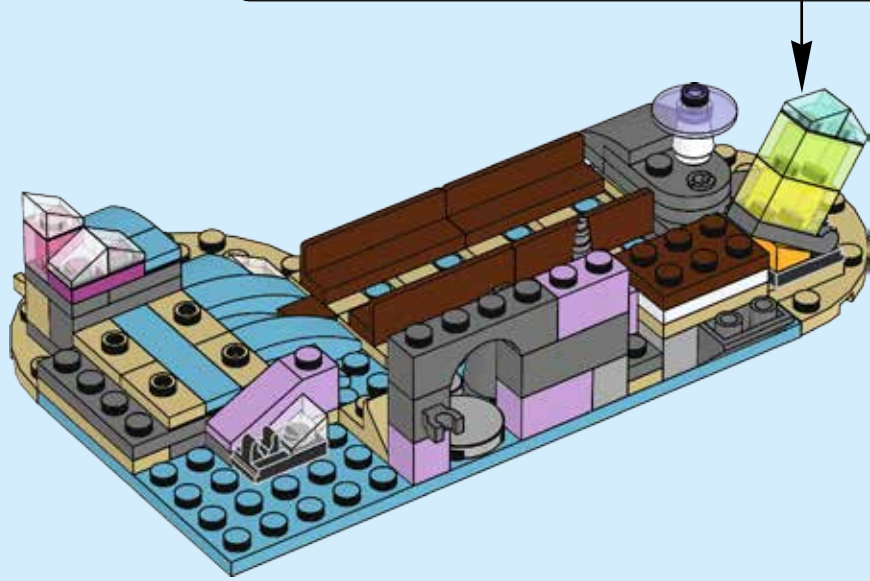
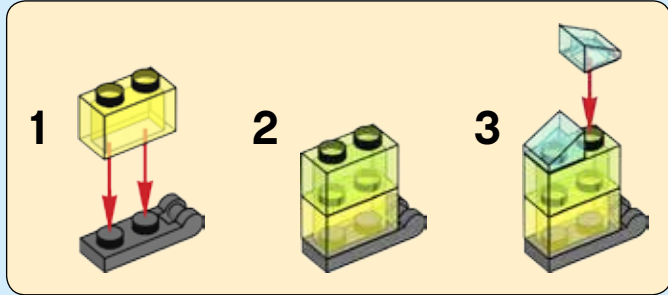

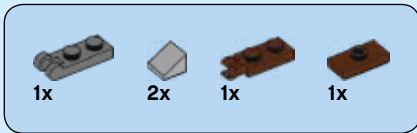

30

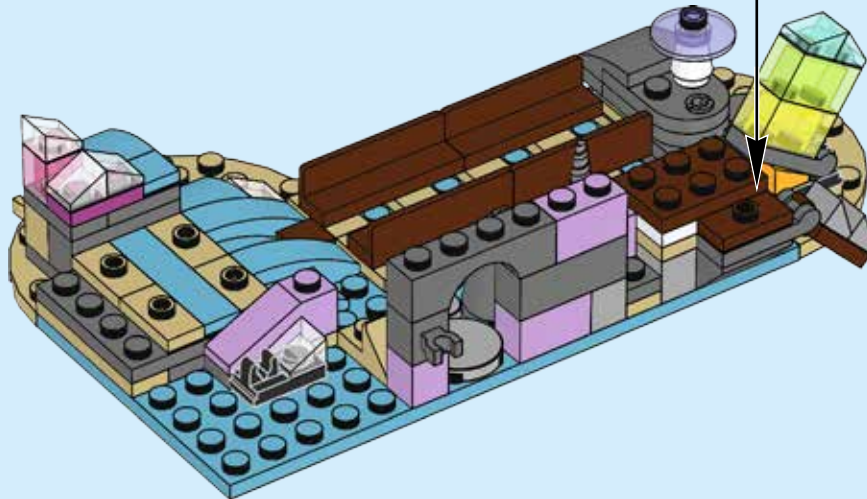
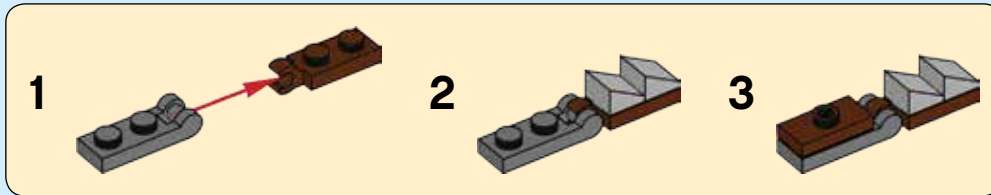



2x



1x



1x

31

1



2

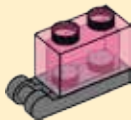

3

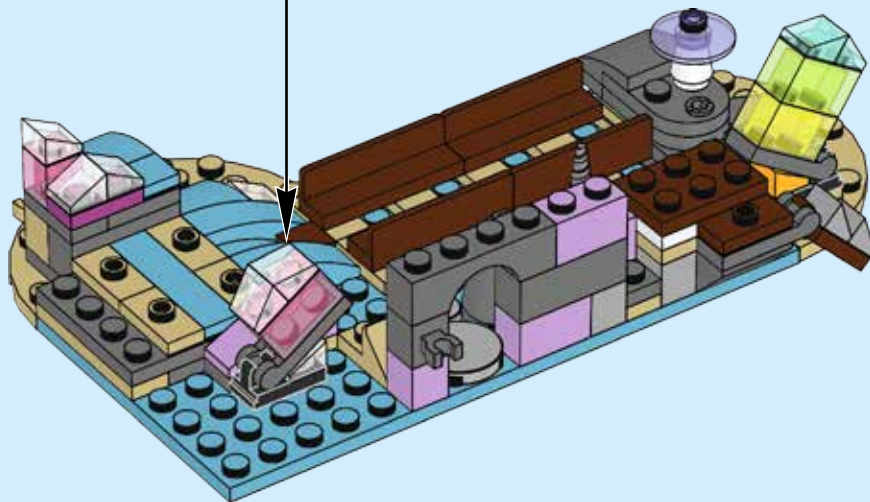

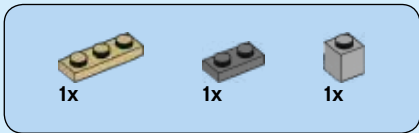

32

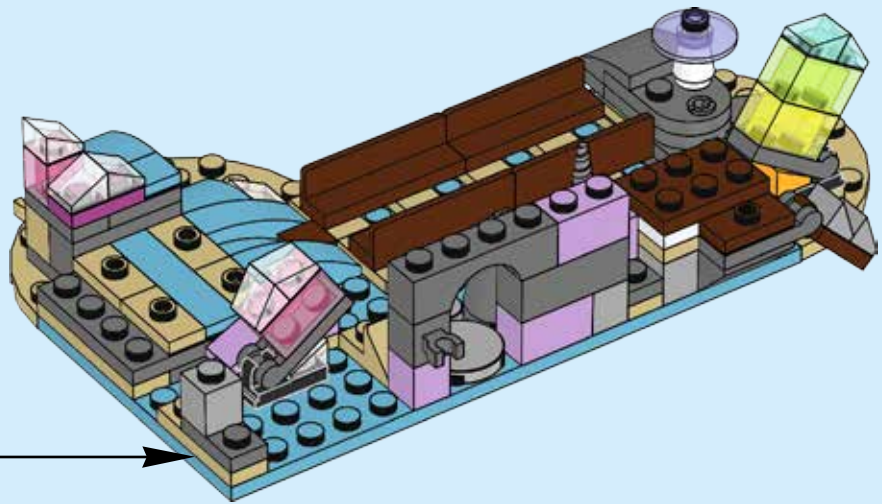
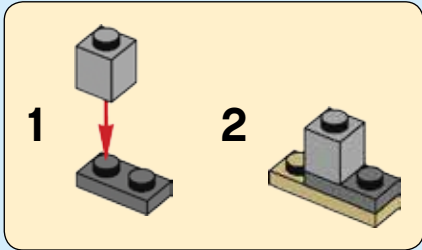

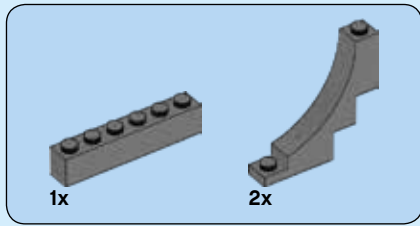

33

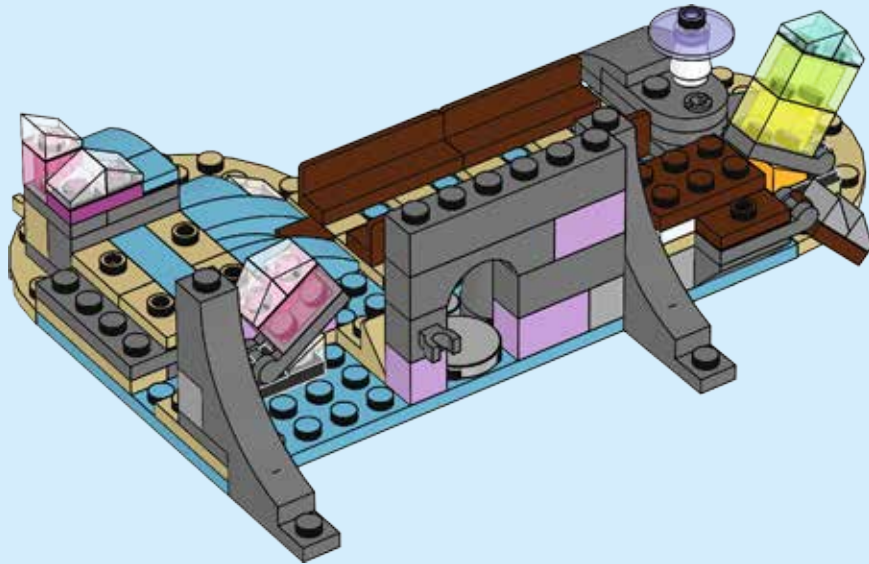



1x



1x

34

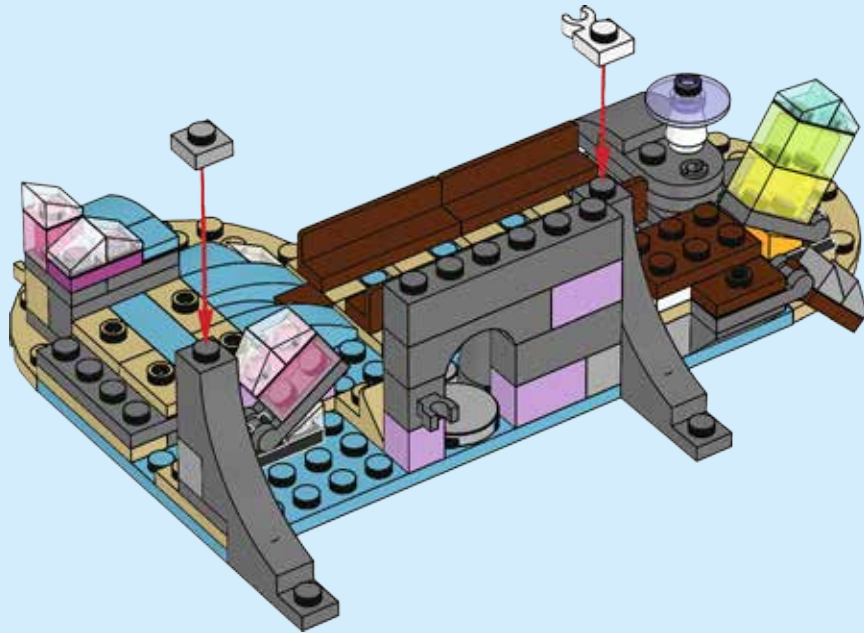

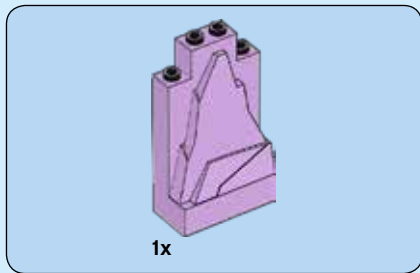

35

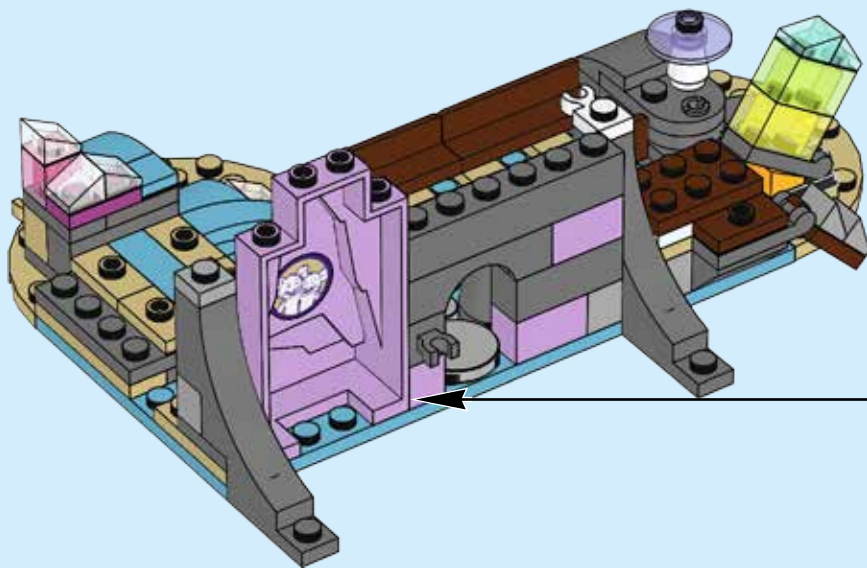
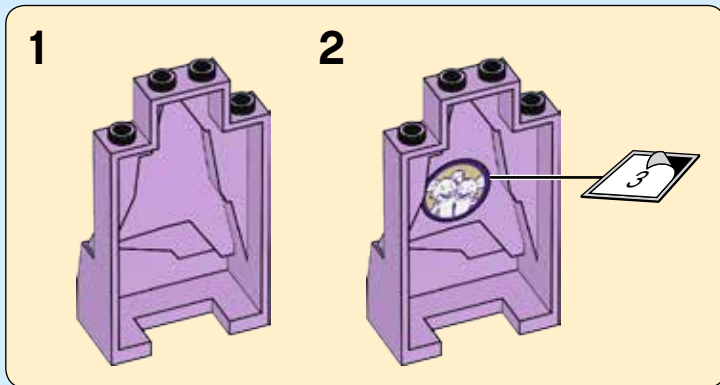



1x



1x

36

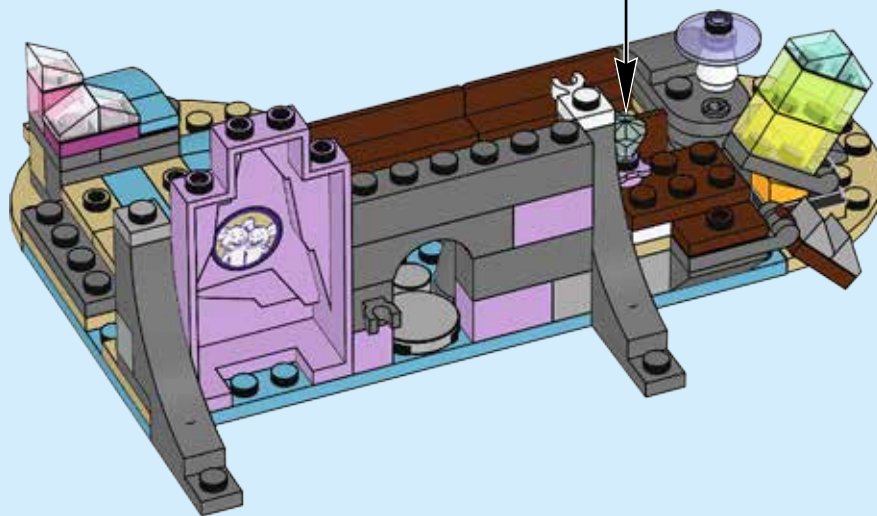
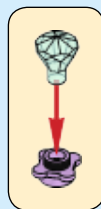

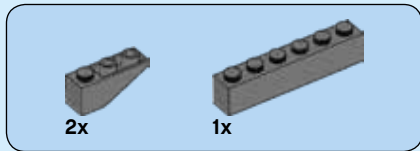

37

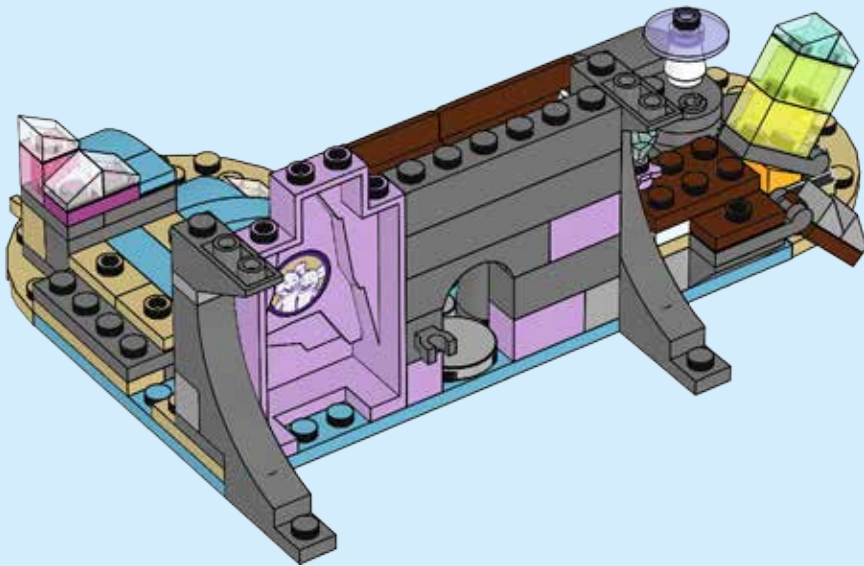

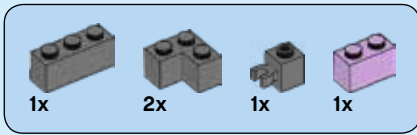

38

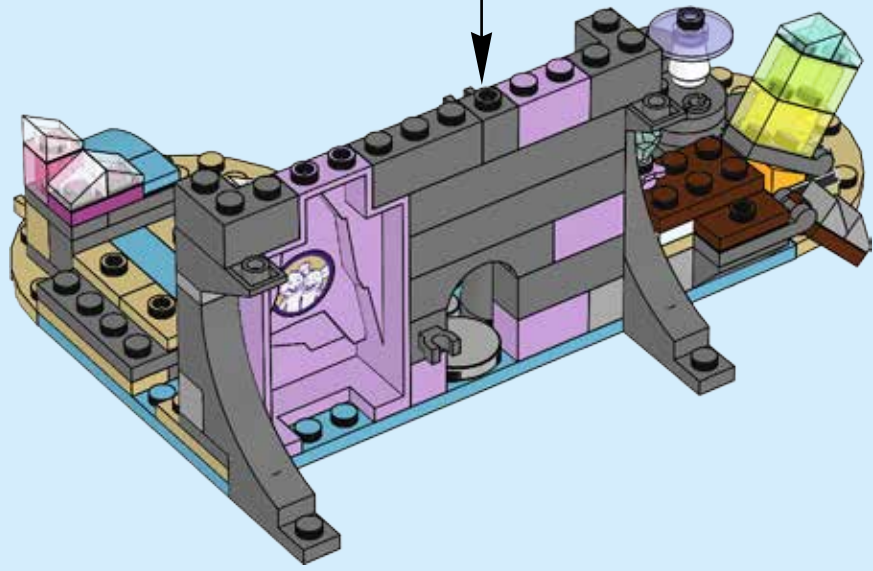
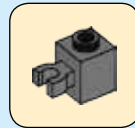

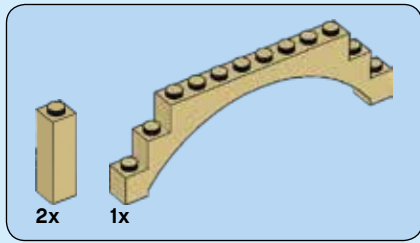

39

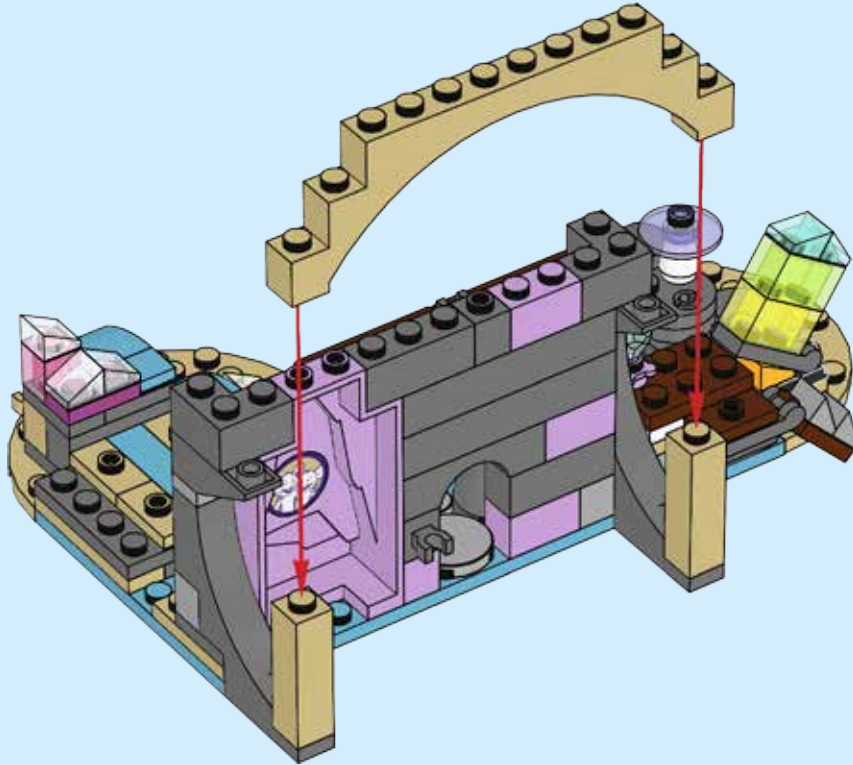



2x

40

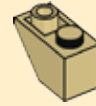

2x

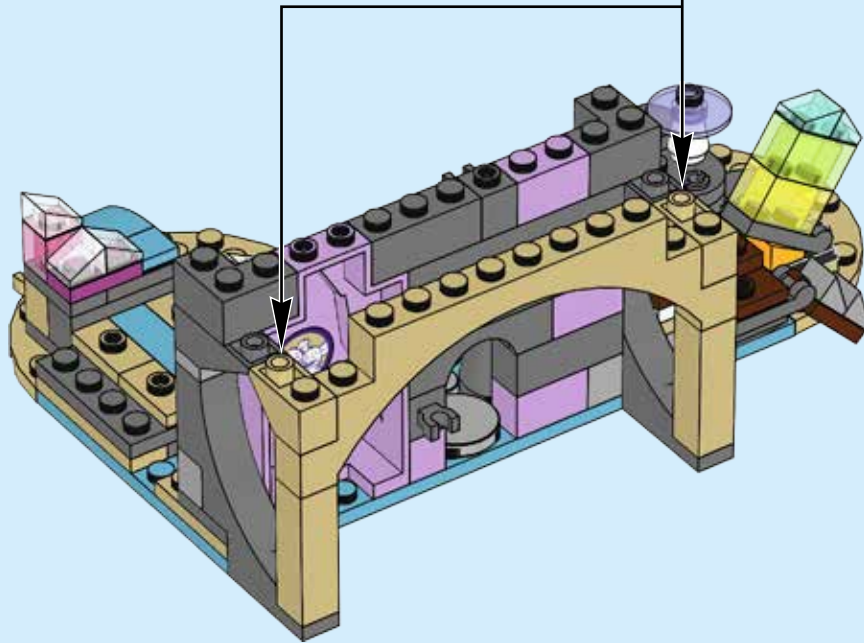



4x

41

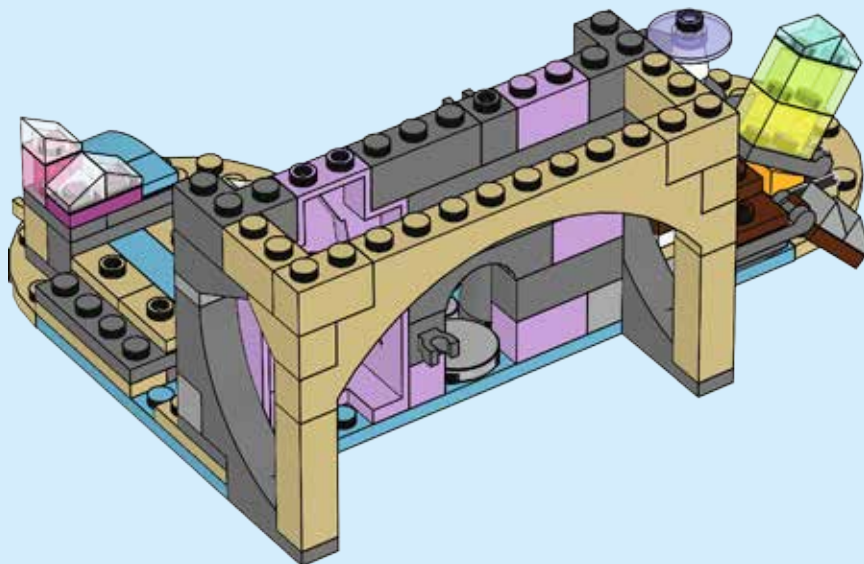

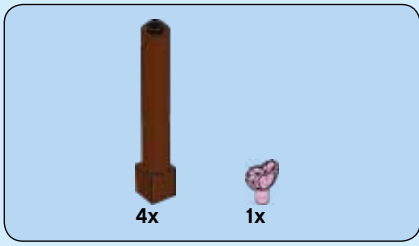

42

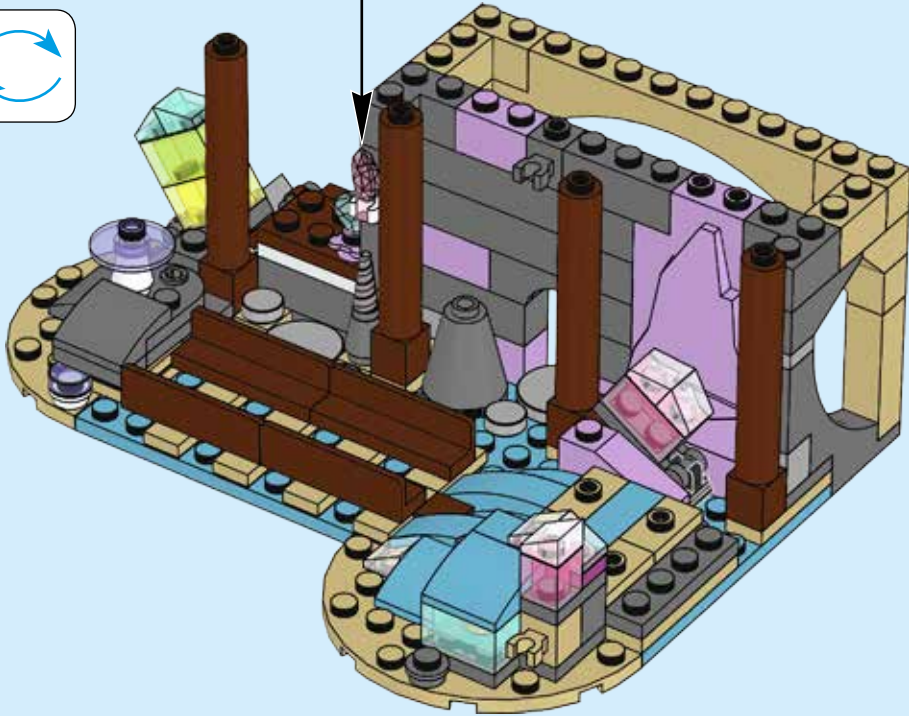
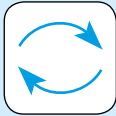



1x



2x

43

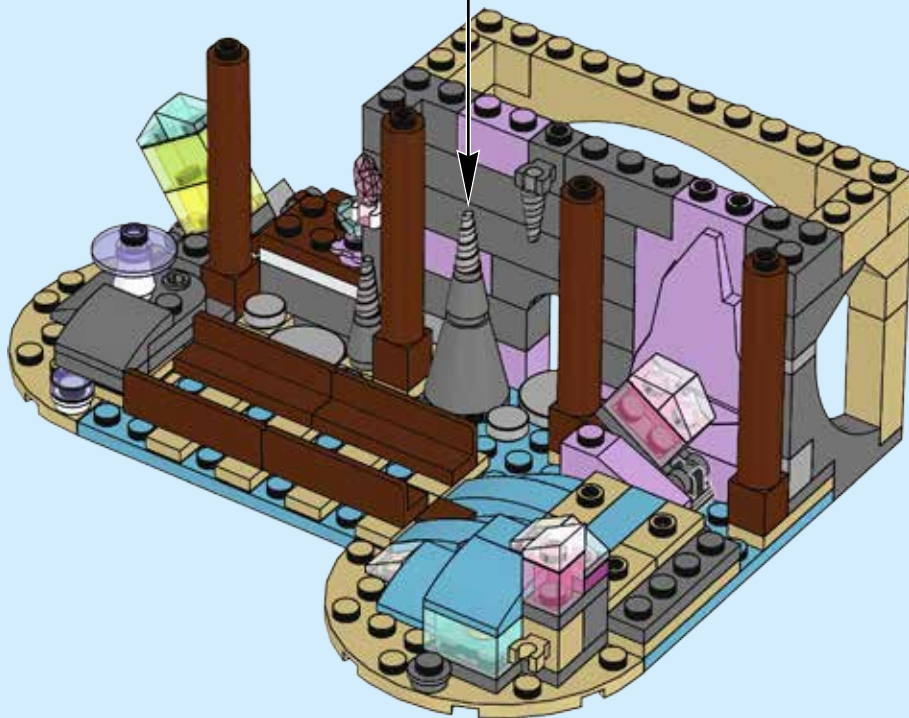
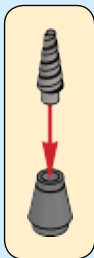

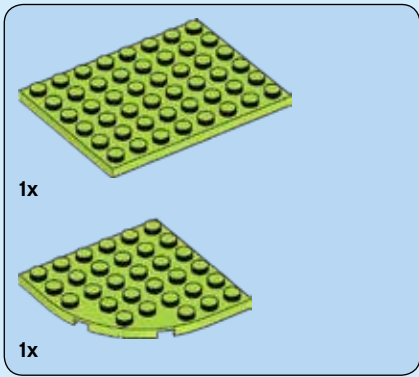

44



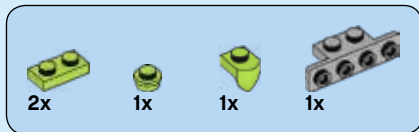

45



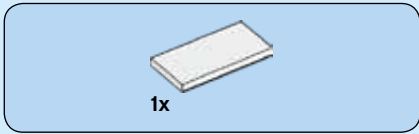

46

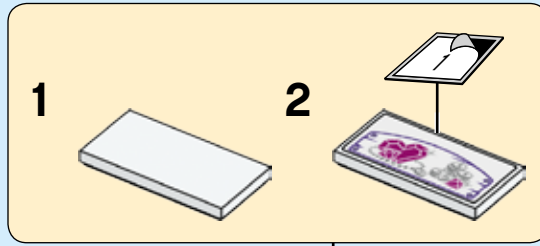

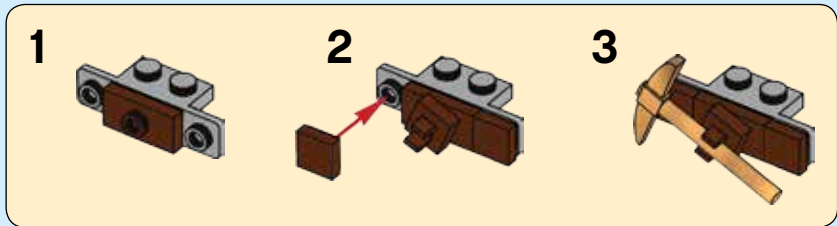
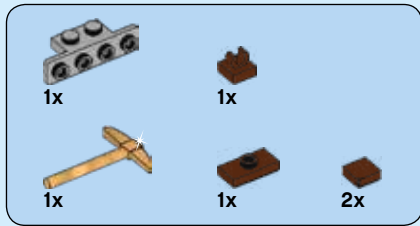

47



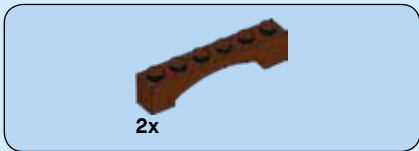

48





49

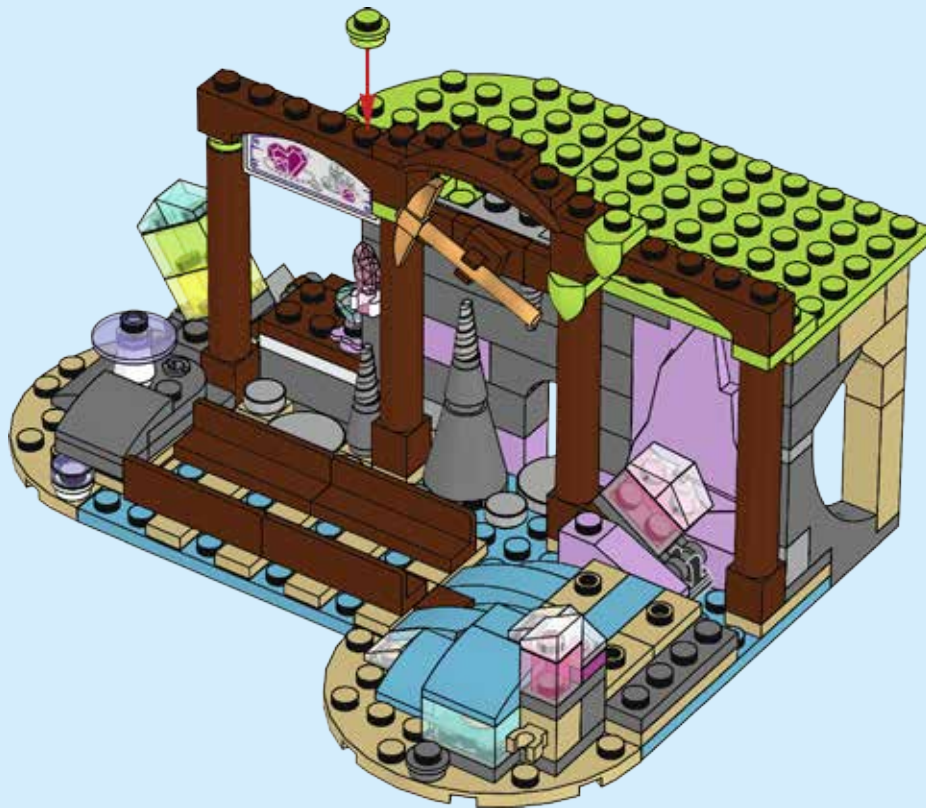



2x

50



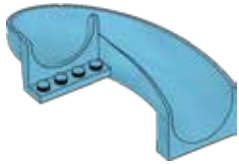

+

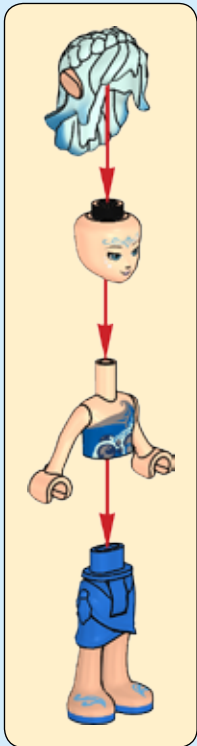

1

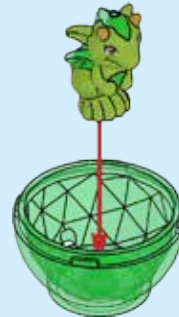

2



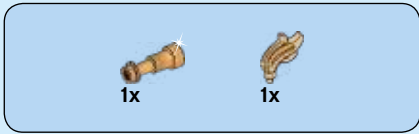

51

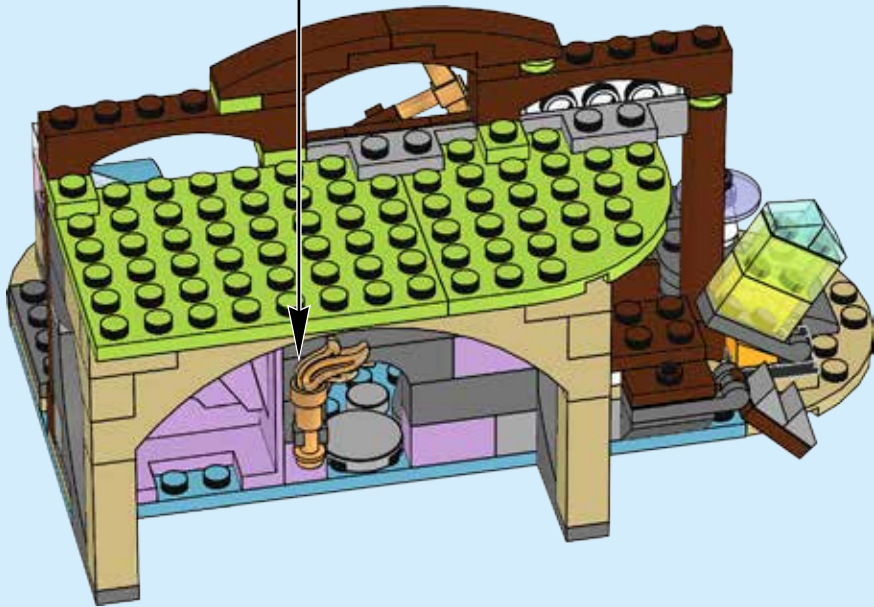
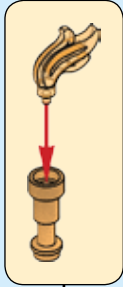
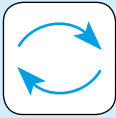

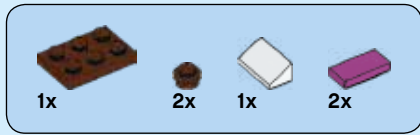

52

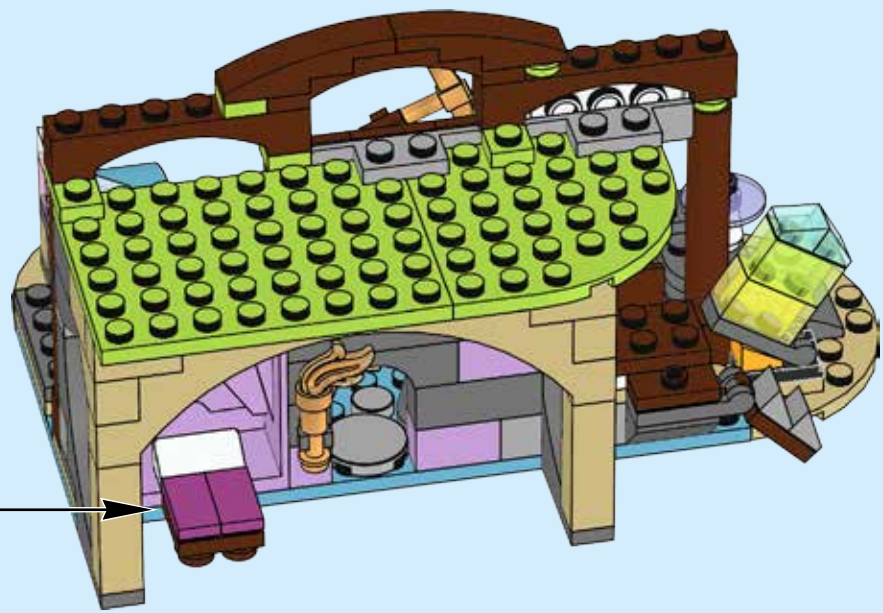
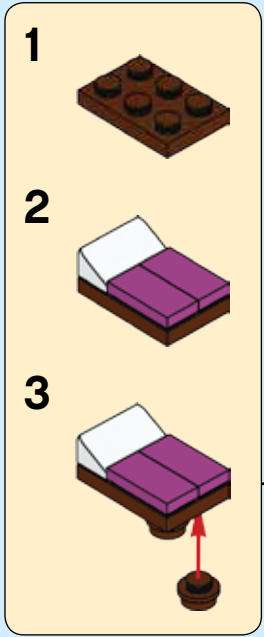

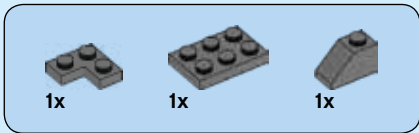

53

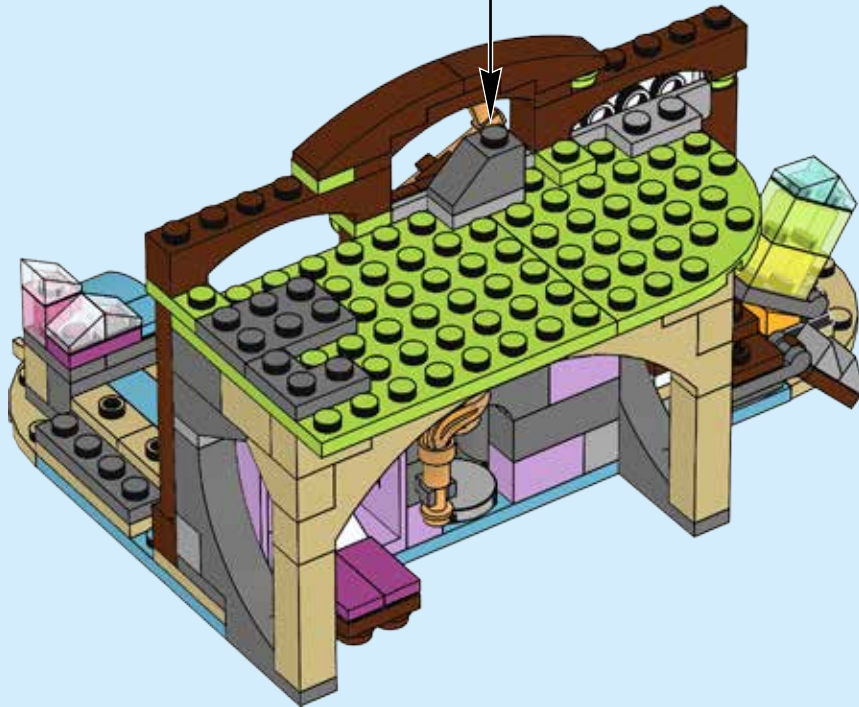
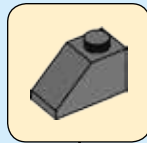



1x



1x

54



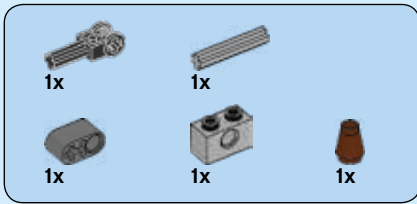

55

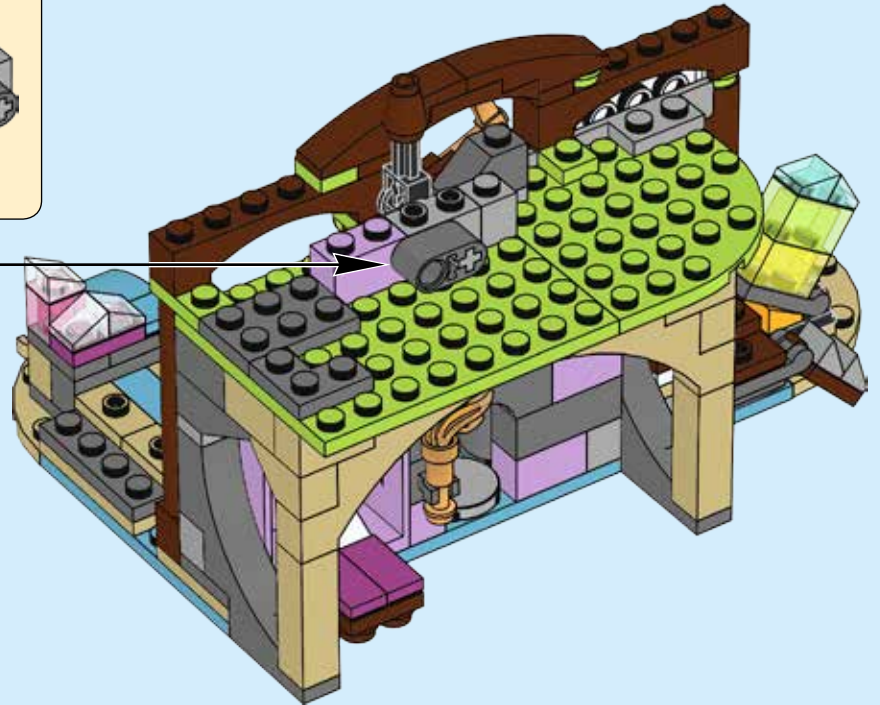
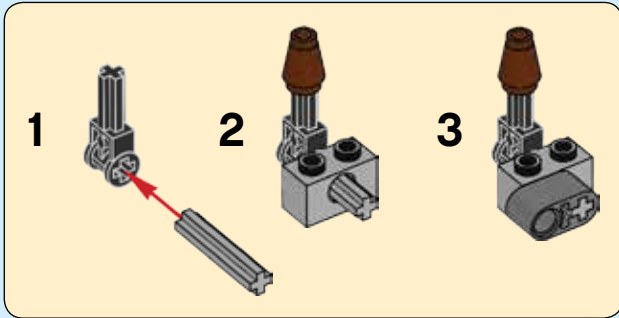

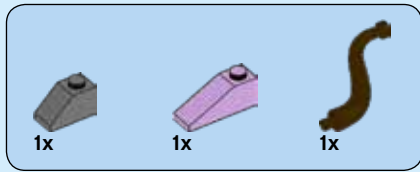

56

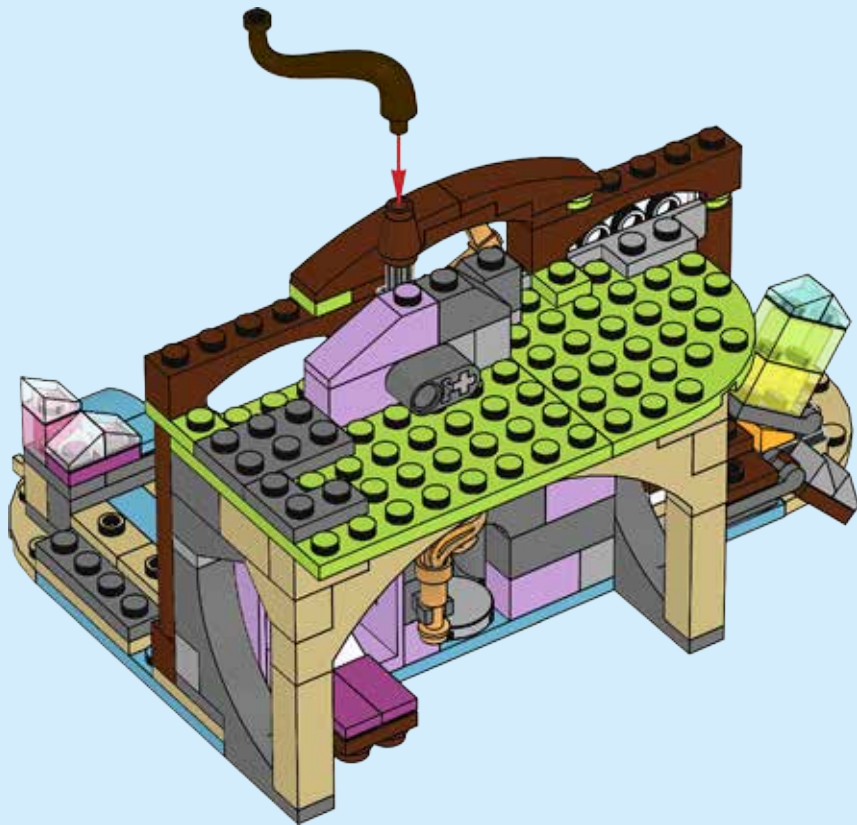



57

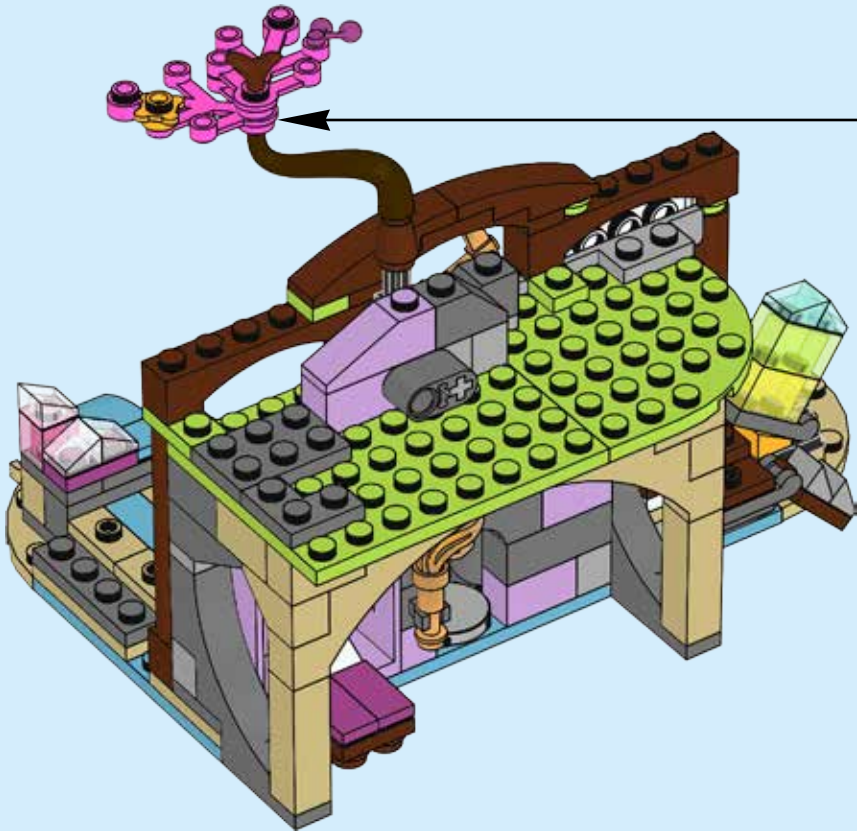
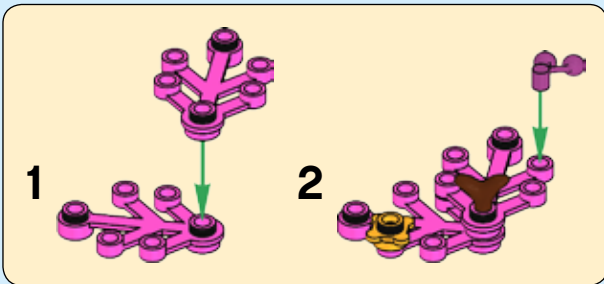

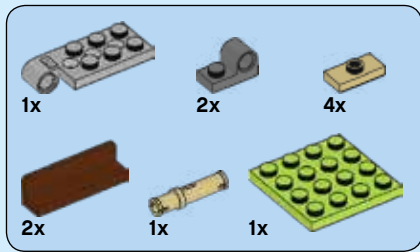

58

1



2

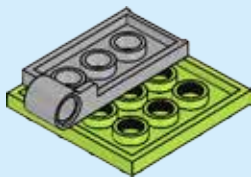

3

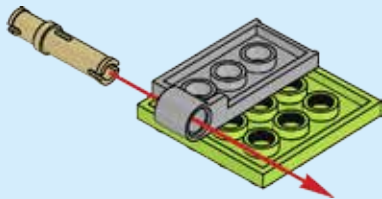

4

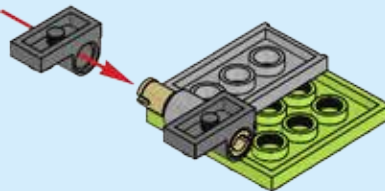

5

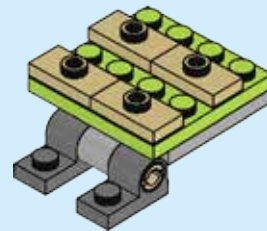

6

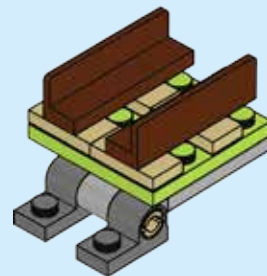

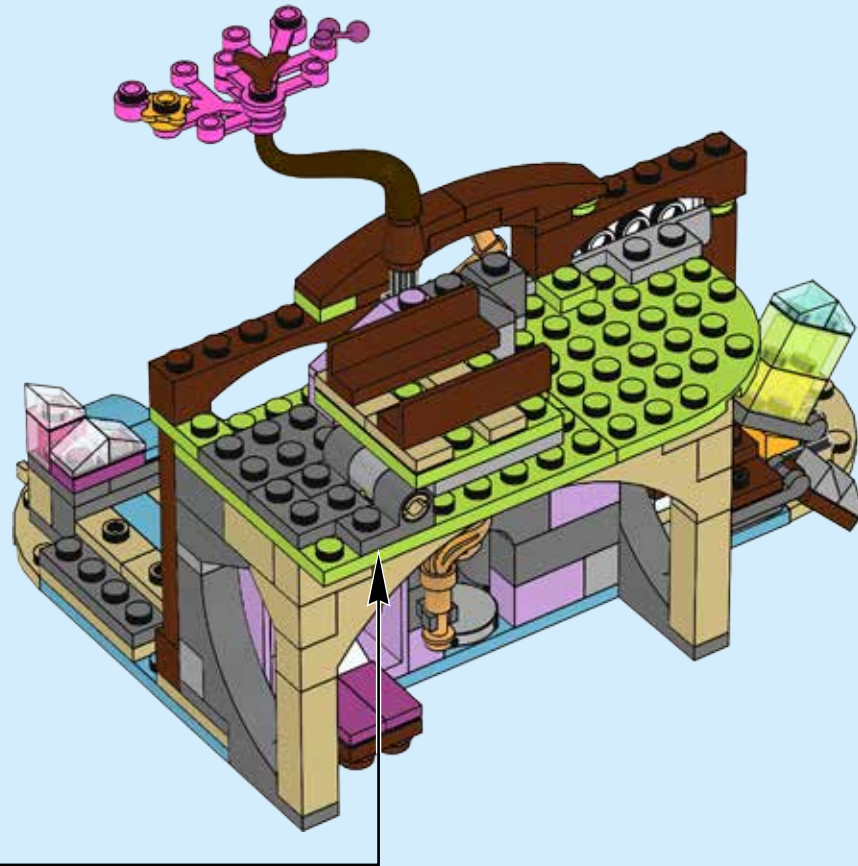

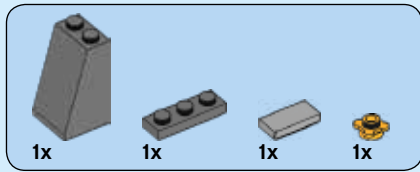

59

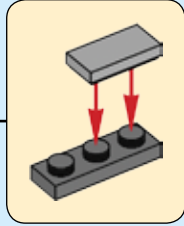
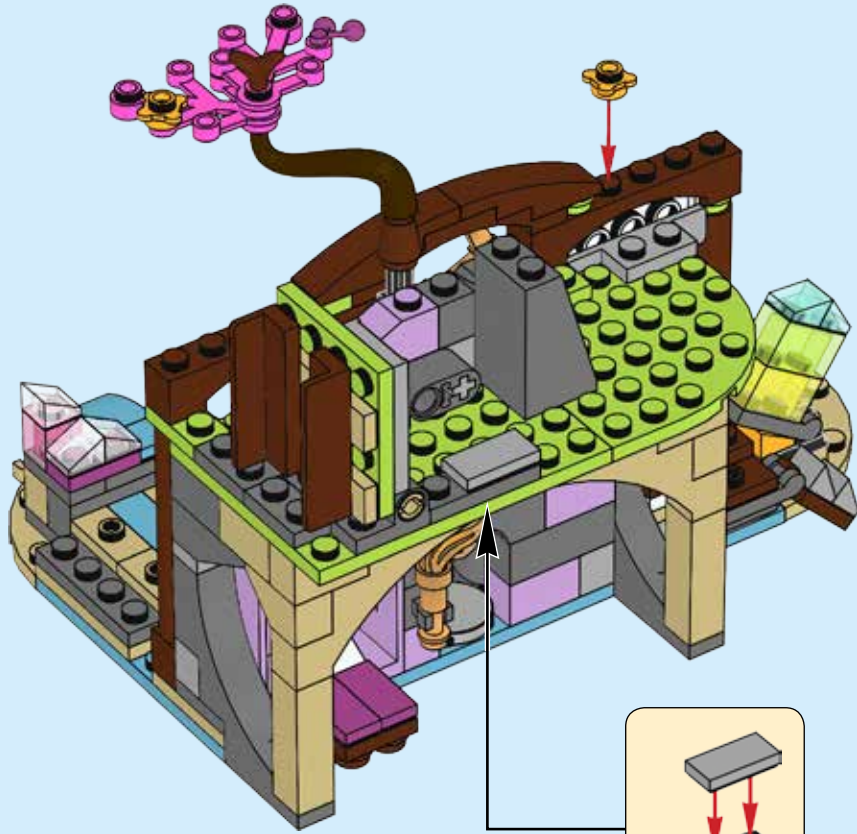

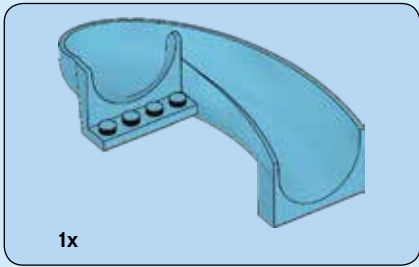

60





1x

61

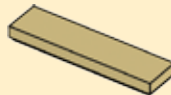
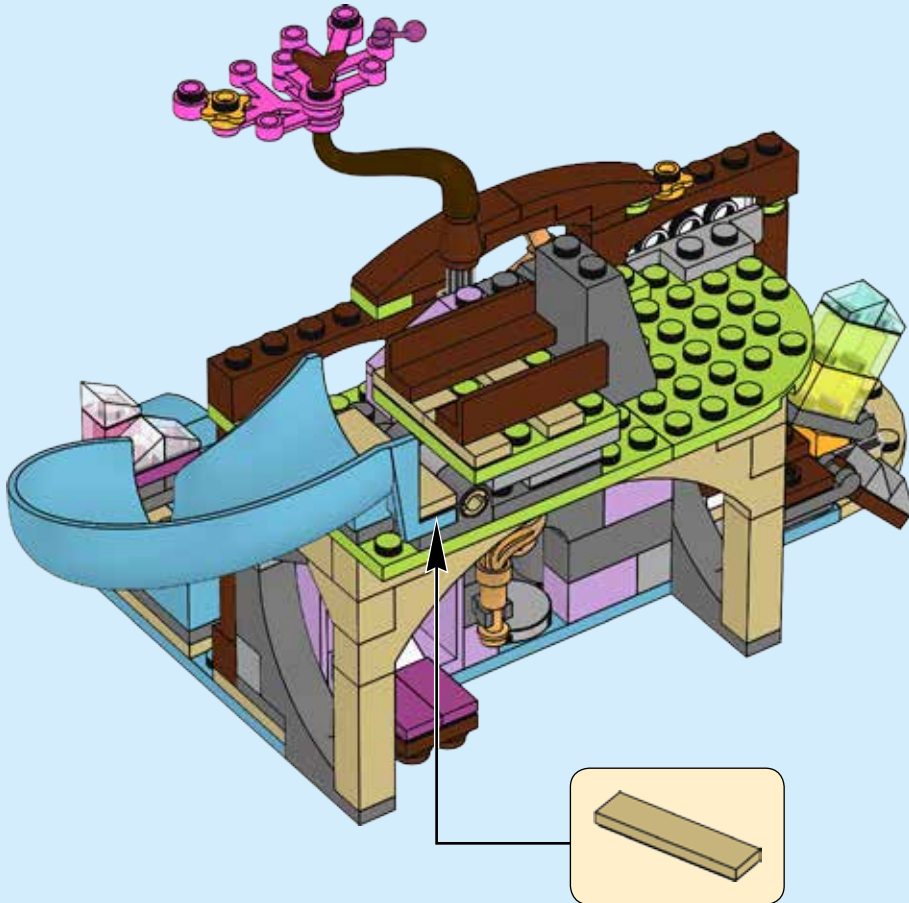

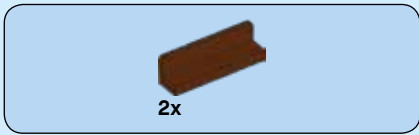

62

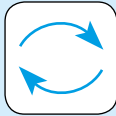

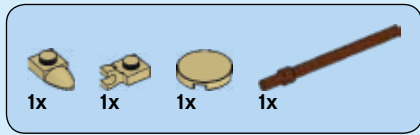

63

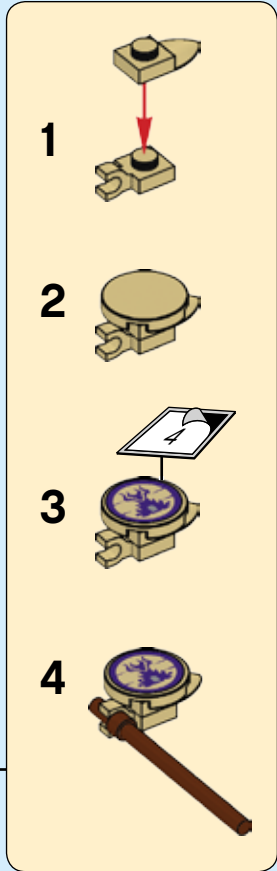
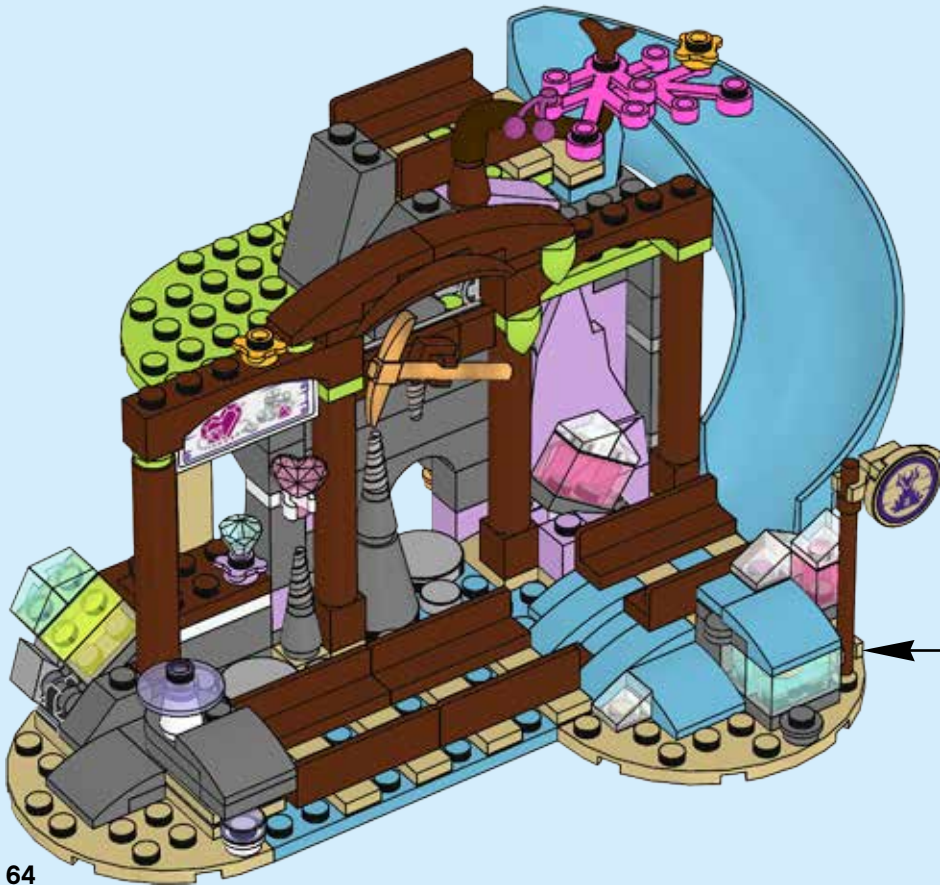

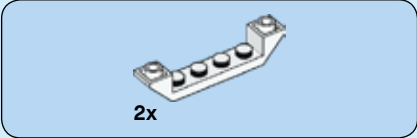
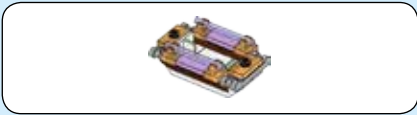

64

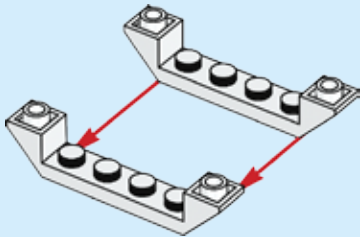

65

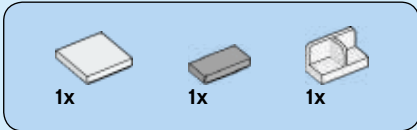
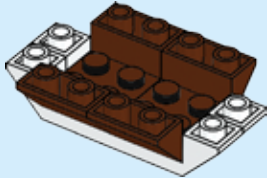

66

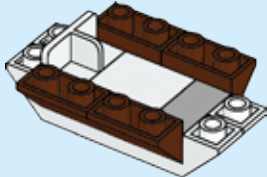



4x



2x

67

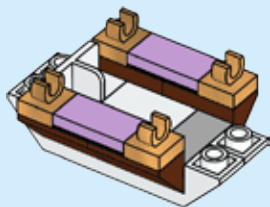

2x



2x

68

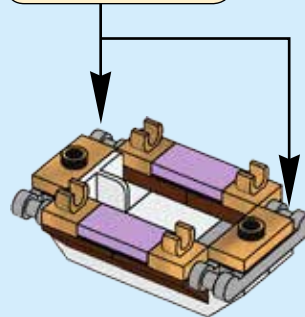
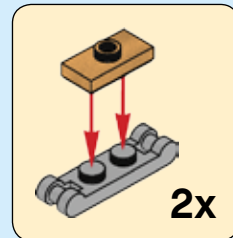

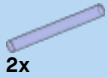

2x

69

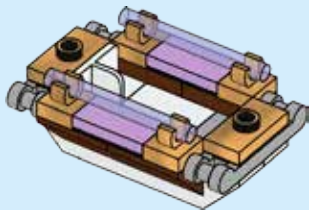

70

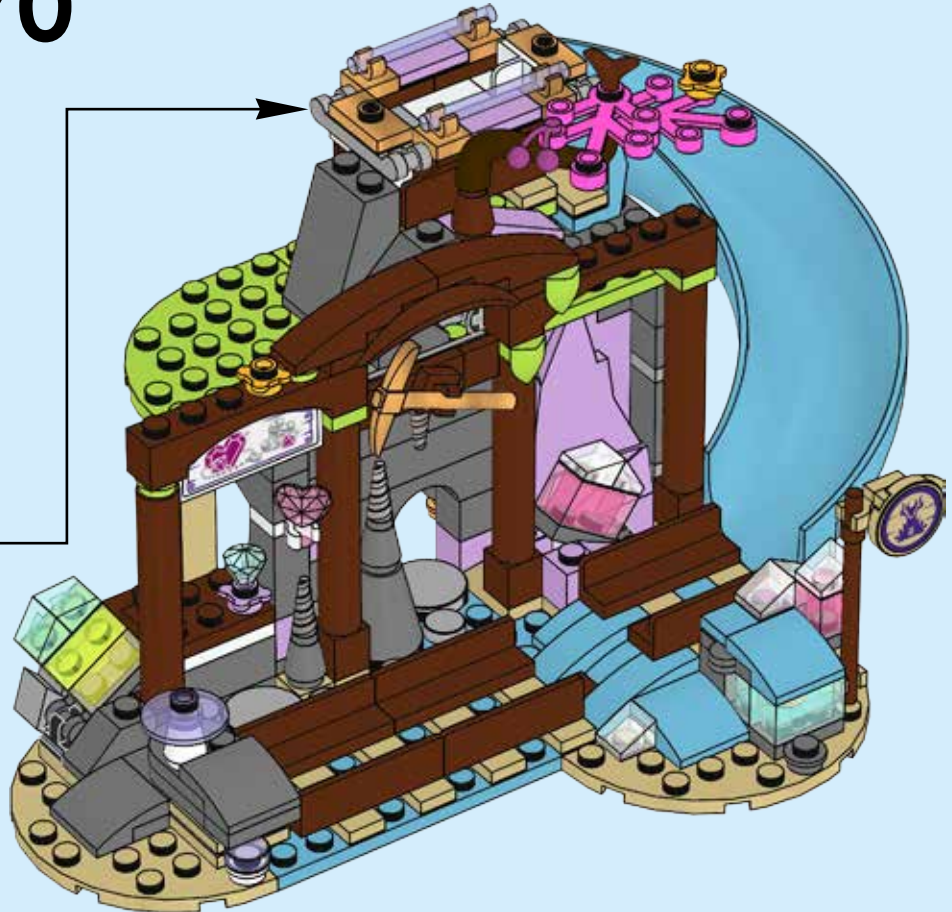

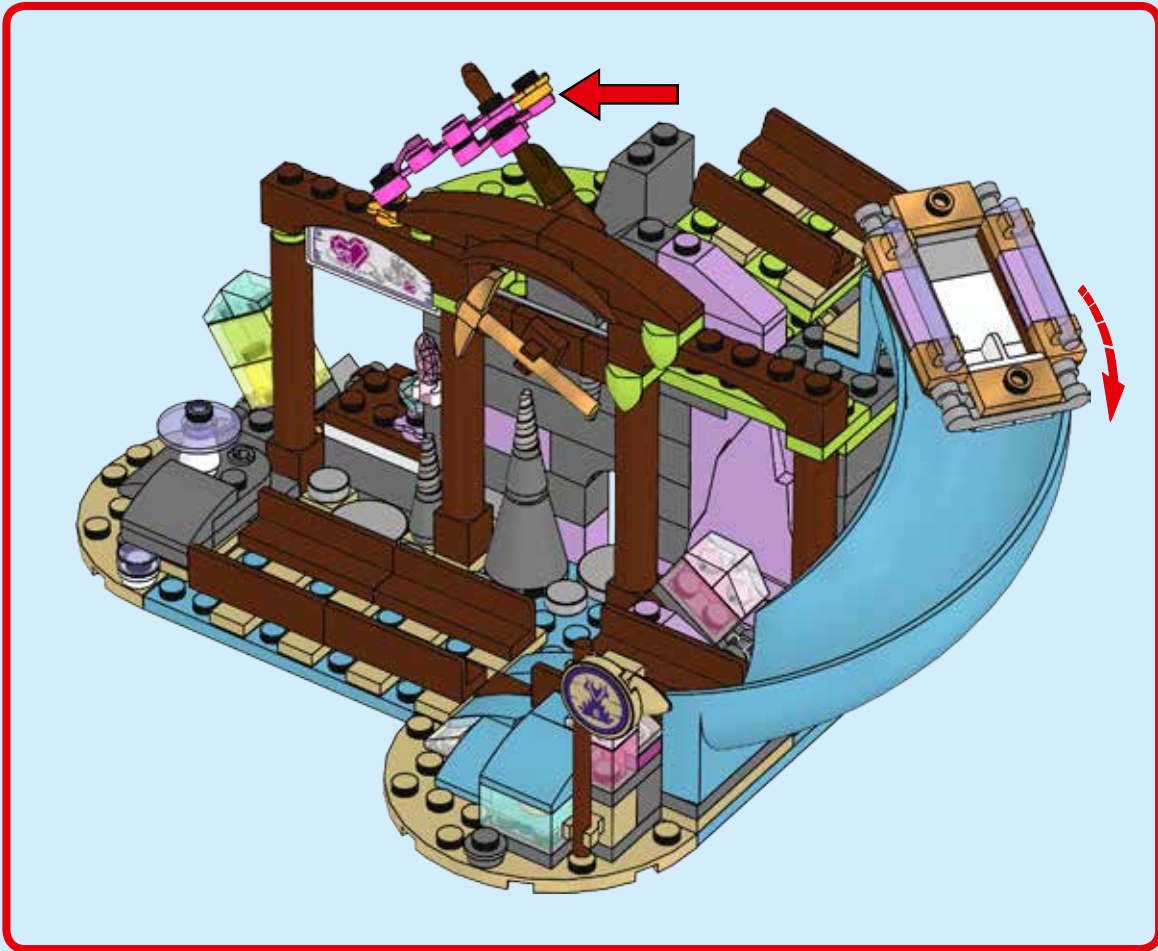



| | | | | | | |
|--|--|---|--|---|--|--|
|  1x 4518400 |  1x 4107765 |  2x 6069165 |  1x 6100562 |  1x 6081496 |  2x 6071274 |  1x 4211190 |
|  1x 614101 |  9x 4244362 |  2x 4159196 |  1x 6103415 |  2x 6058337 |  1x 6062574 |  2x 6045941 |
|  1x 4613256 |  1x 4119482 |  1x 4565387 |  2x 4611415 |  2x 6097448 |  3x 4211288 |  2x 6039192 |
|  1x 4547489 |  2x 6073445 |  1x 6141978 |  1x 6097512 |  2x 6096995 |  1x 6136802 |  1x 6081990 |
|  1x 6093479 |  2x 6138481 |  1x 4514554 |  2x 4544069 |  2x 6096995 |  1x 6078605 |  1x 6022038 |
|  1x 4222017 |  1x 4646861 |  3x 4121921 |  1x 4649066 |  2x 4183133 |  1x 6069984 |  2x 4655611 |
|  1x 242001 |  1x 4646860 |  2x 4113233 |  2x 4624184 |  2x 6138659 |  1x 4211151 |  6x 4650260 |
|  2x 306801 |  2x 6057517 |  1x 4550324 |  2x 6023173 |  2x 4164037 |  3x 6092590 |  1x 6152335 |
|  1x 302101 |  1x 4224793 |  1x 4114309 |  1x 4529242 |  1x 4504850 |  1x 6008297 |  2x 4521921 |
|  1x 4560178 |  1x 4520947 |  3x 6123812 |  2x 4216581 |  1x 6129601 |  2x 4211189 |  1x 4211399 |
|  2x 4259937 |  1x 6136390 |  1x 6096383 |  1x 6151628 |  1x 6100914 |  8x 6092659 |  4x 4211389 |
|  1x 6135537 |  1x 6066344 |  16x 6092587 |  1x 6133881 |  2x 4598528 |  4x 4520612 |  3x 6052200 |
|  2x 4598528 |  4x 4109995 | |  1x 6133851 | | |  1x 4211440 |

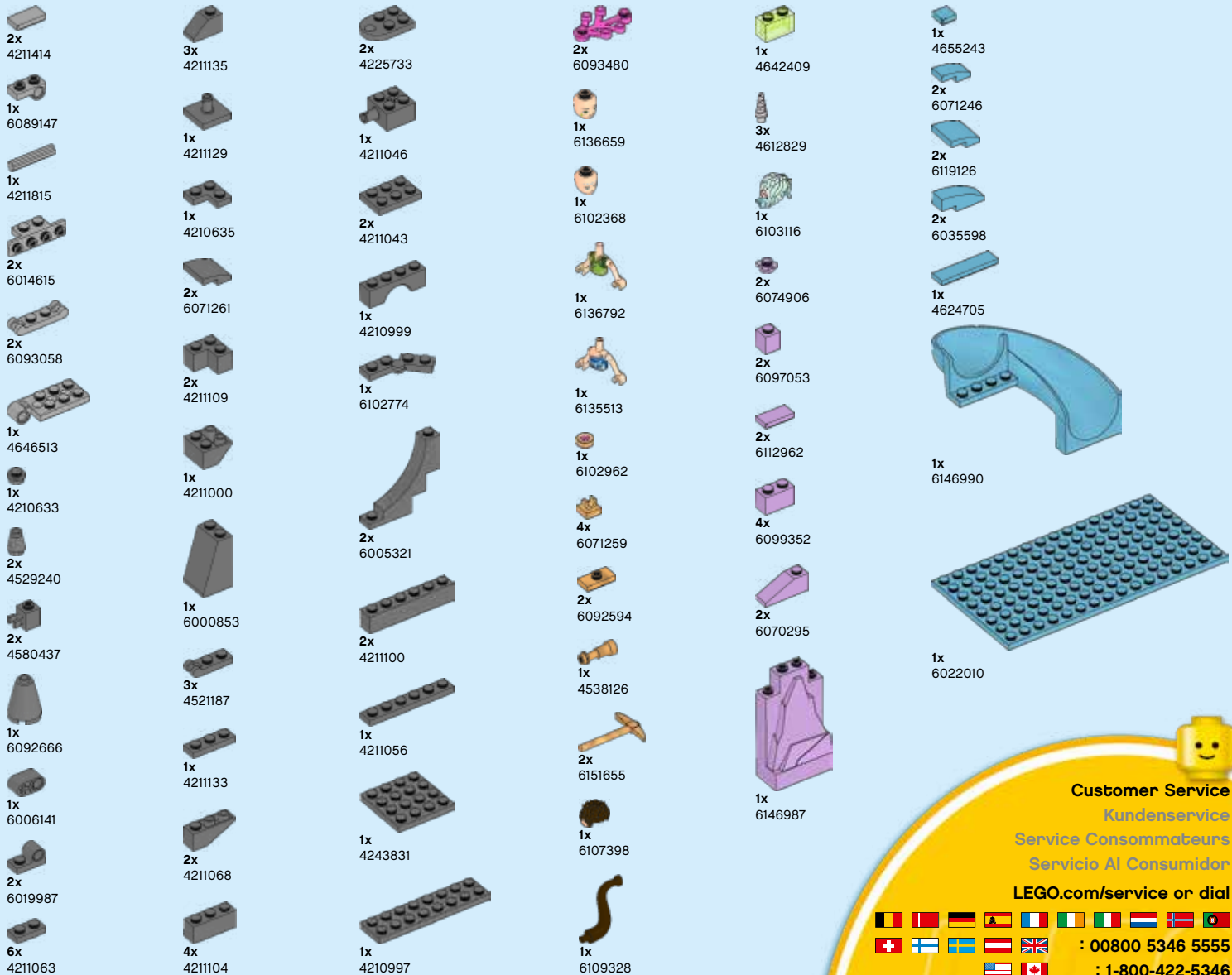

Customer Service
Kundenservice
Service Consommateurs
Servicio Al Consumidor
LEGO.com/service or dial





ELVES







ELVES



41178



41180



41177



41179



41176



41175



41174



41173



41172



41171

LEGO

ELVES



Free
app
game



 LEGO.com/elves

Apple, the Apple logo and iPad are trademarks of Apple Inc.
Google Play is a trademark of Google Inc.

 Download on the
App Store

ANDROID APP ON
 **Google play**

WIN

GO TO WWW.LEGO.COM/PRODUCTFEEDBACK AND
GIVE US YOUR SHORT **FEEDBACK** ABOUT THIS
LEGO® SET FOR A CHANCE TO WIN
A COOL LEGO PRIZE.

Terms & Conditions apply



LEGO.com/productfeedback

GEWINNE



Erzähle uns auf
www.LEGO.com/productfeedback

etwas über die Erfahrungen, die du mit
diesem LEGO® Set gemacht hast, und
sichere dir die Chance auf einen coolen
LEGO Preis!

Es gelten die Teilnahmebedingungen

GAGNE



Rends-toi sur
www.LEGO.com/productfeedback

et donne-nous quelques commentaires
sur ce produit LEGO® pour avoir une
chance de gagner un prix LEGO !

Voir Conditions Générales

GANAN



Visita
www.LEGO.com/productfeedback

y envíanos tu opinión acerca de este set
LEGO®. ¡Participarás en el sorteo de un
premio LEGO!

Términos y Condiciones aplicables

获取奖品



登录
www.LEGO.com/productfeedback

给出关于此乐高®套装的简短反馈，
就有机会获得炫酷乐高奖品

《条款及条件》适用