

**LEGO**

**MARVEL**  
**SUPER**  
**HEROES**



76032





[LEGO.com/brickseparator](http://LEGO.com/brickseparator)



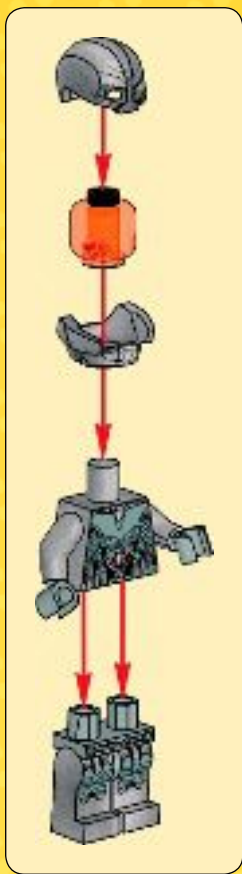



1



2

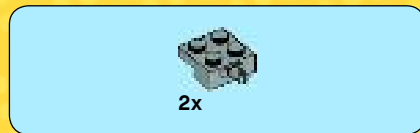

3

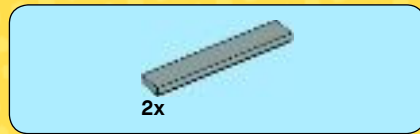
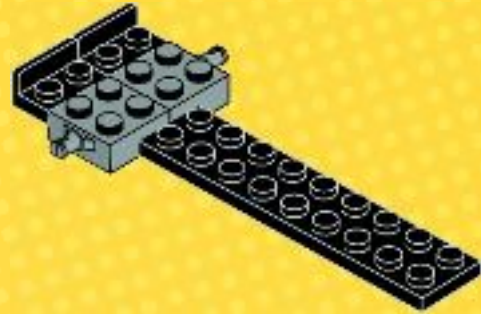

4

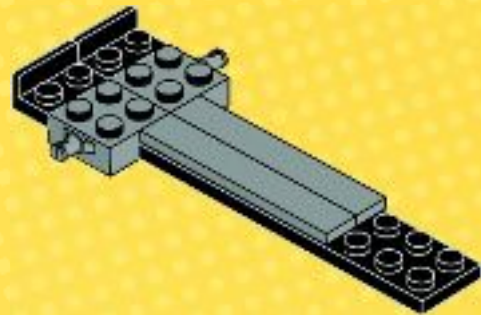



2x

5

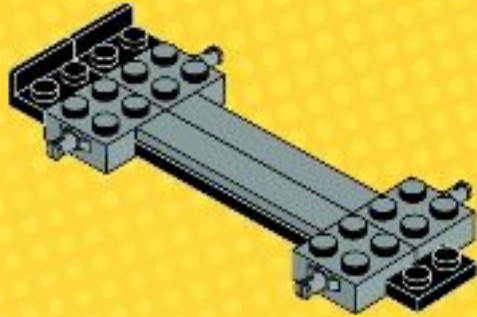

2x

6

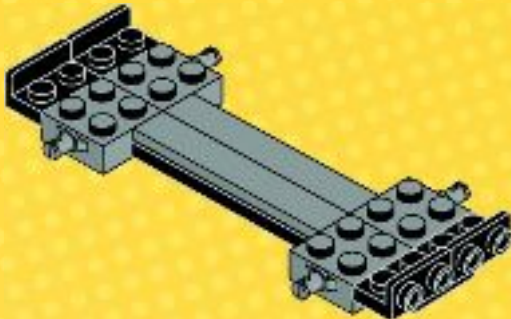

1x

7

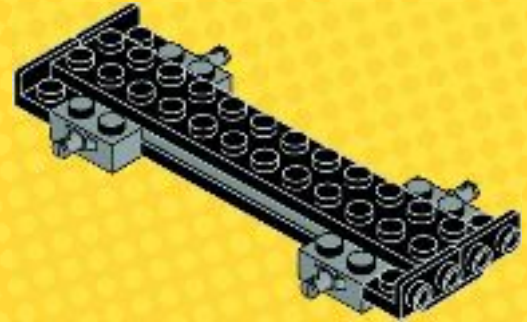

4x

8

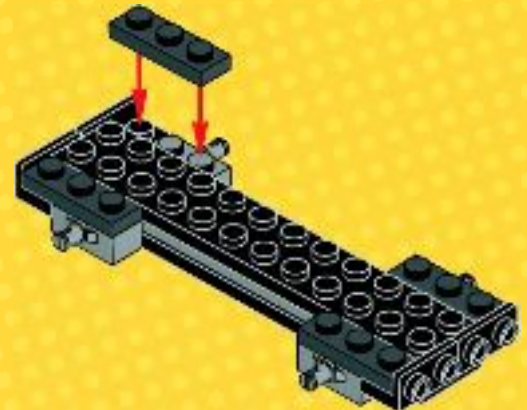



1x

9

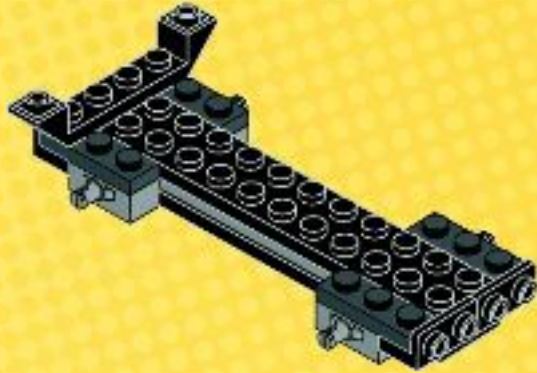

2x

10

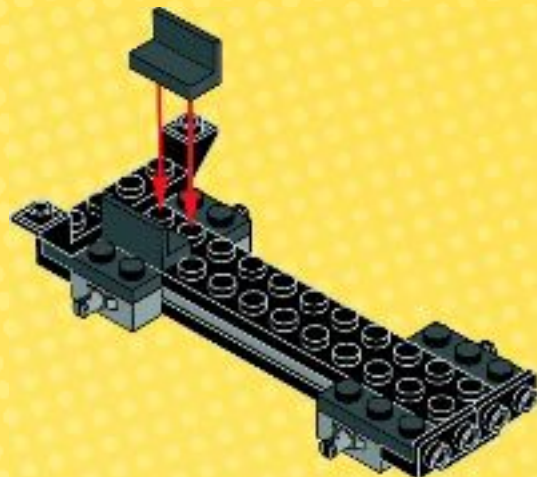

2x

11



1x

12





13

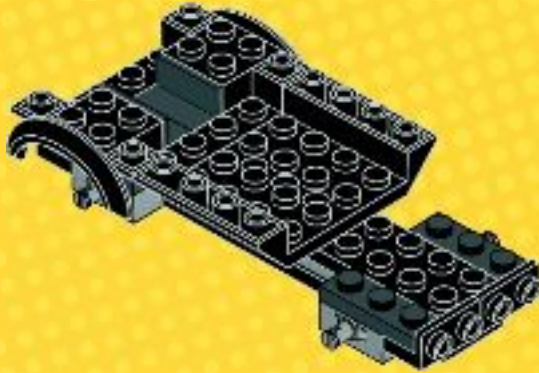

14

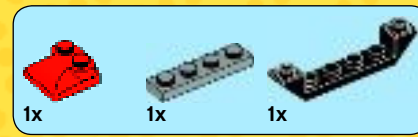

15

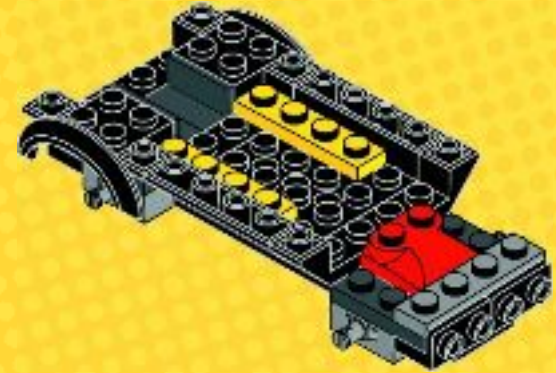

16

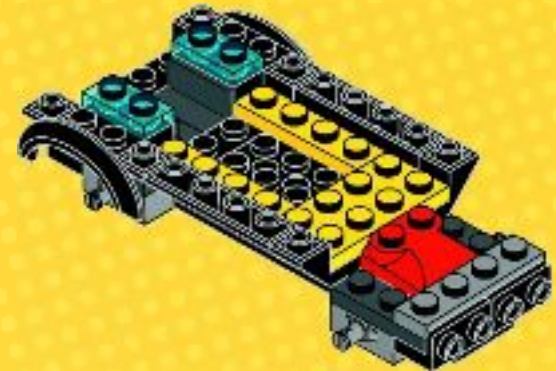



17

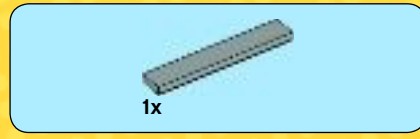
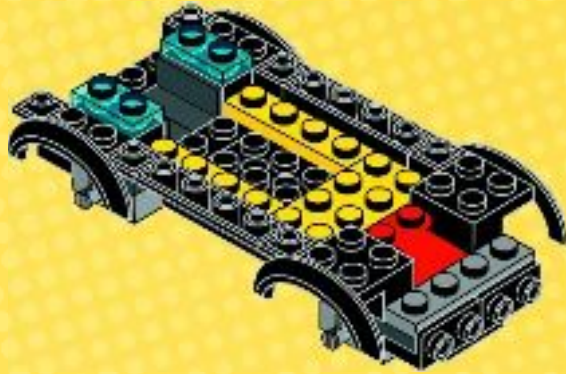

18

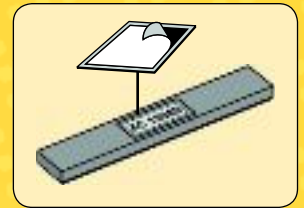
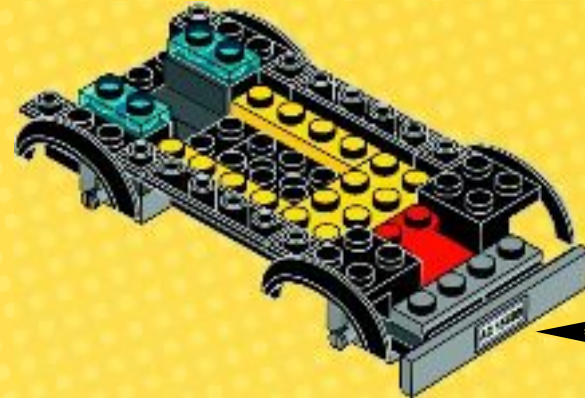



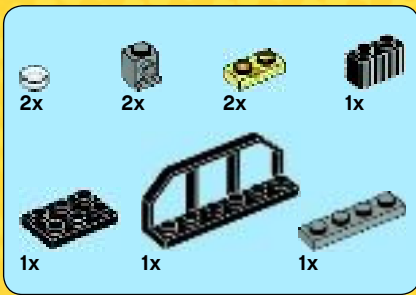

# 19

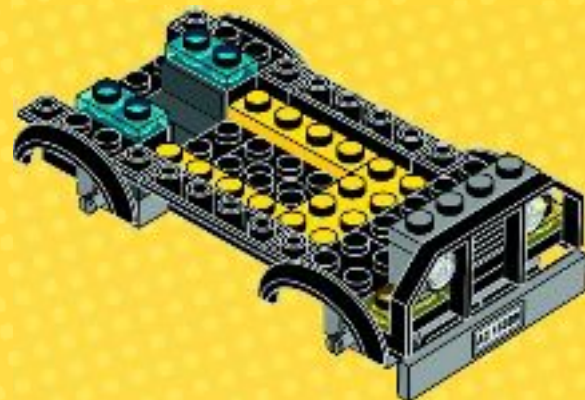
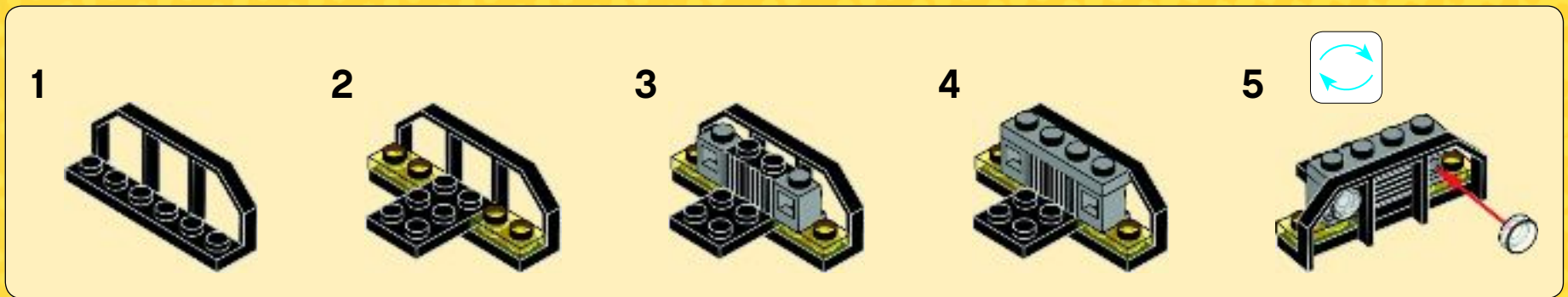

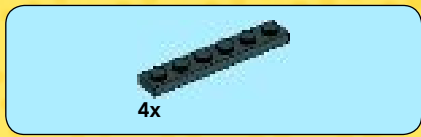

# 20

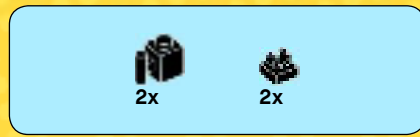
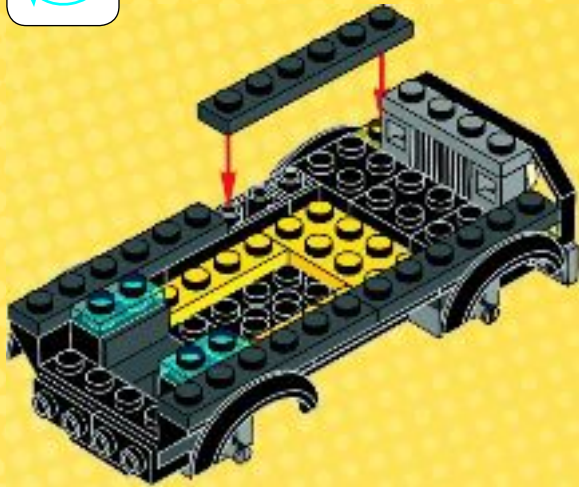

# 21

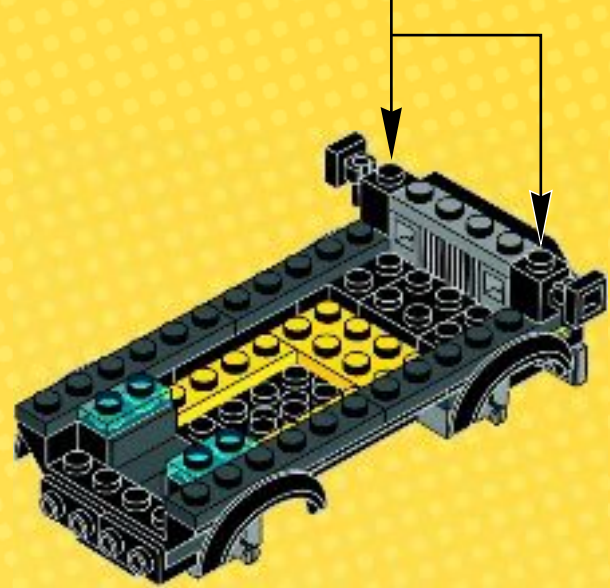
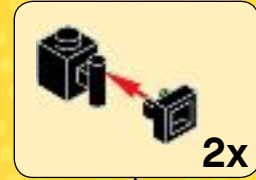



# 22

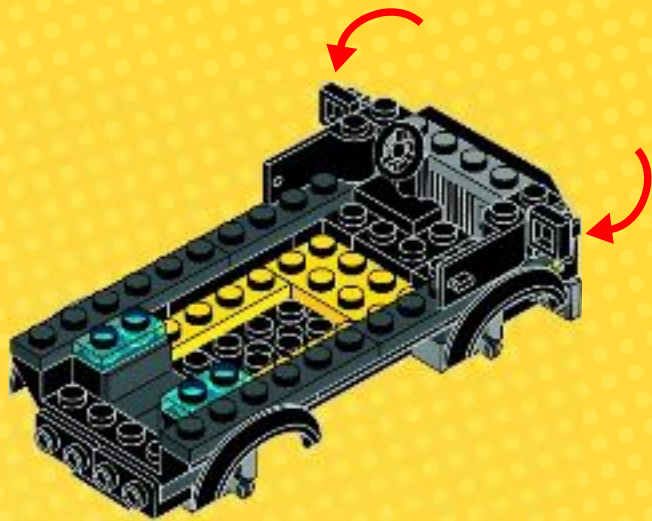

# 23

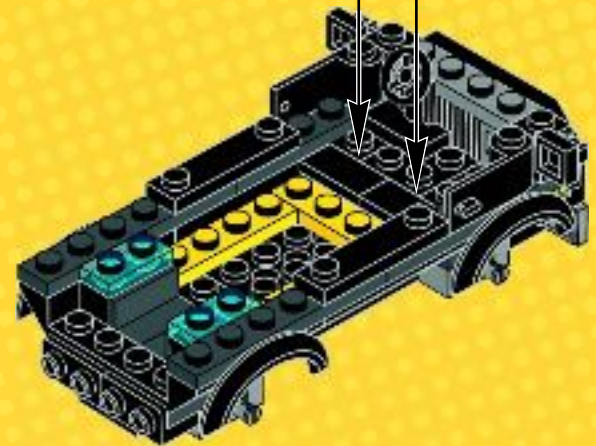

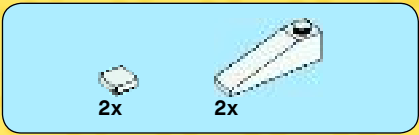

# 24

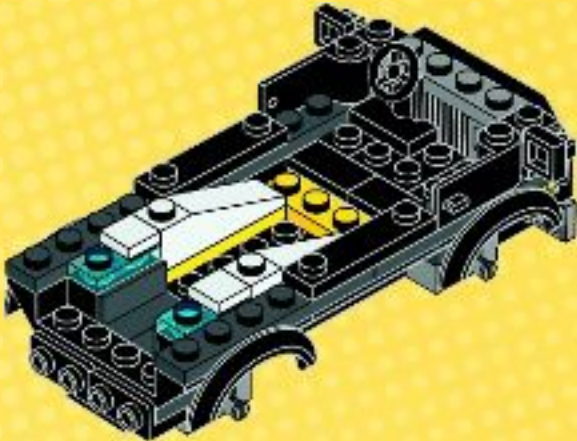

# 25

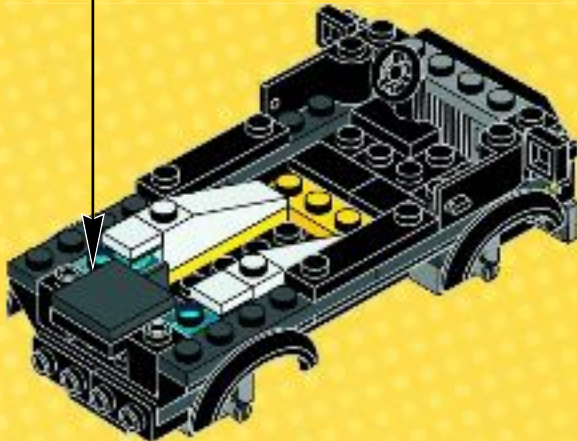
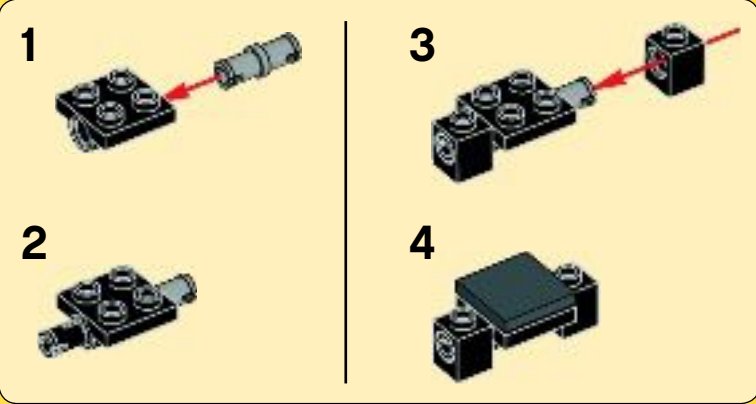



# 26

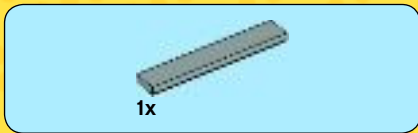
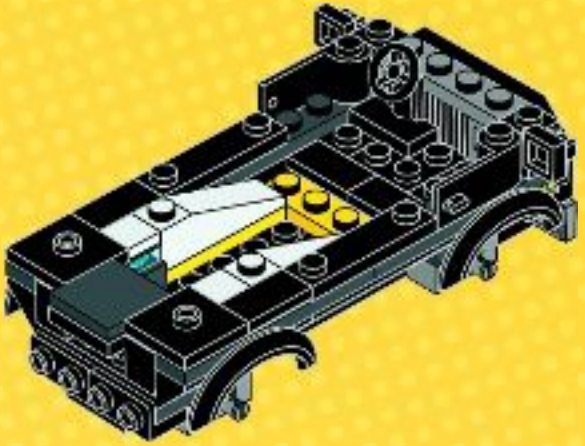

# 27

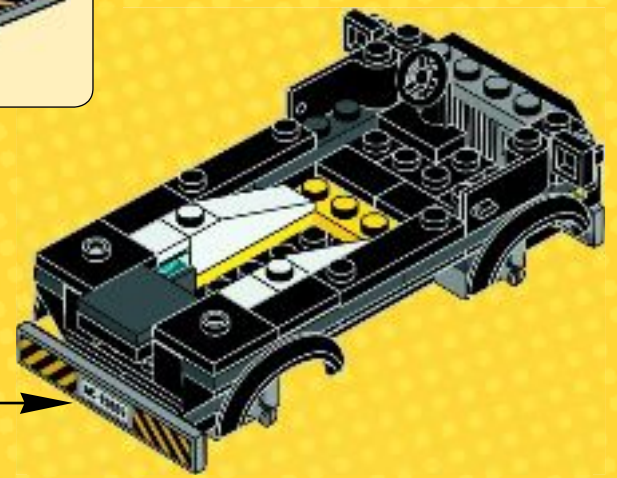
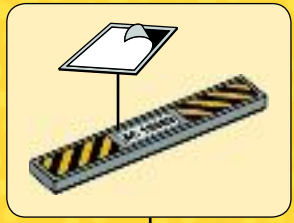

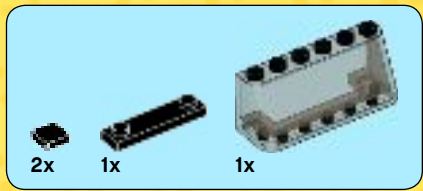

28

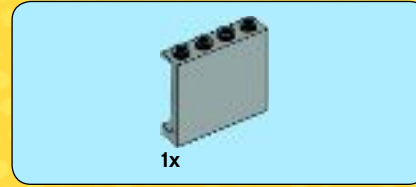
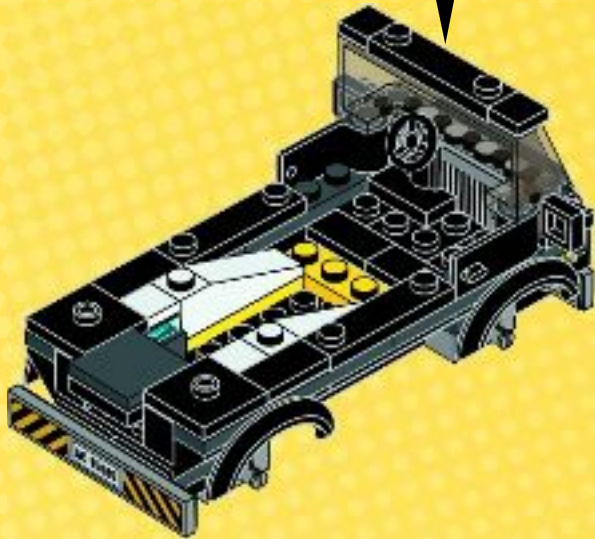
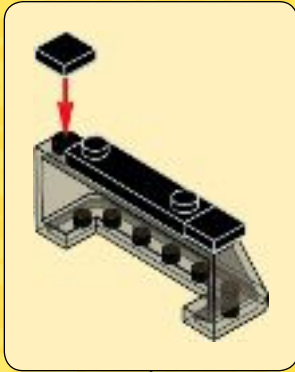

29

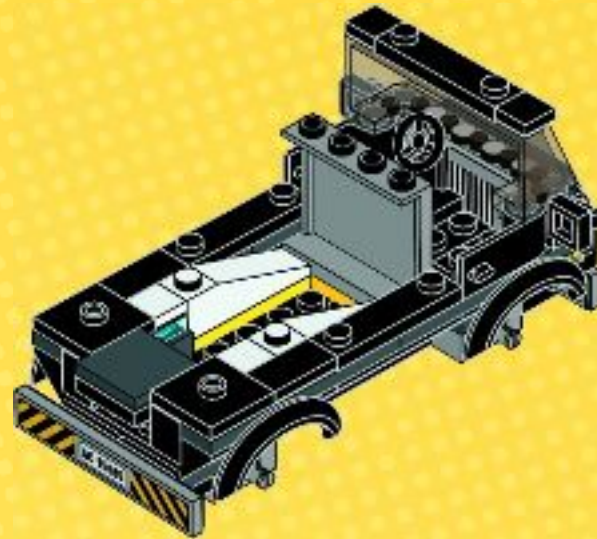



2x

# 30

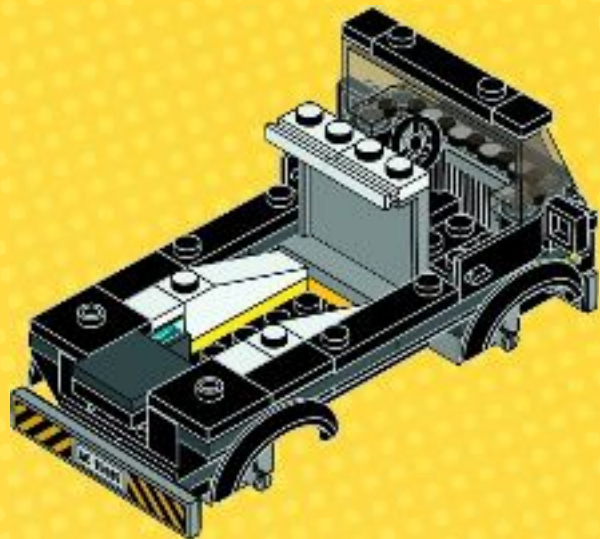

2x



4x

# 31

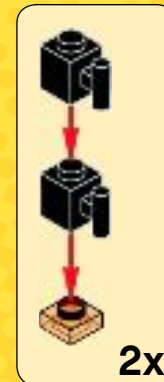

2x

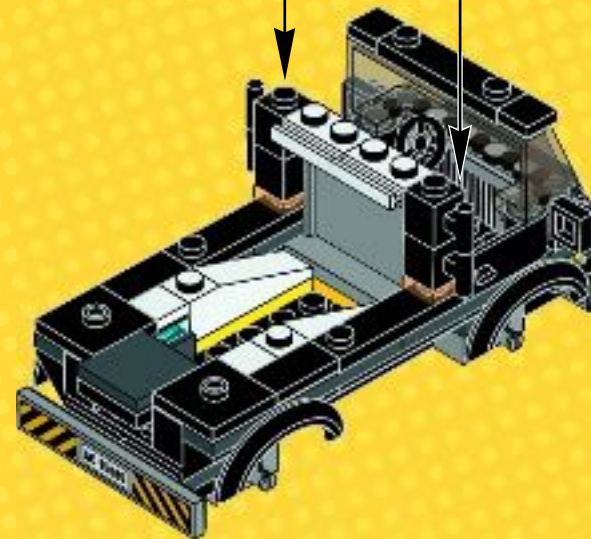

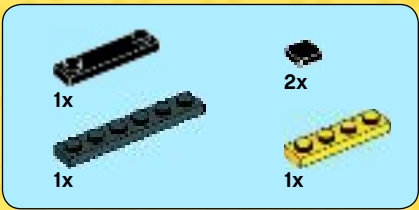

# 32

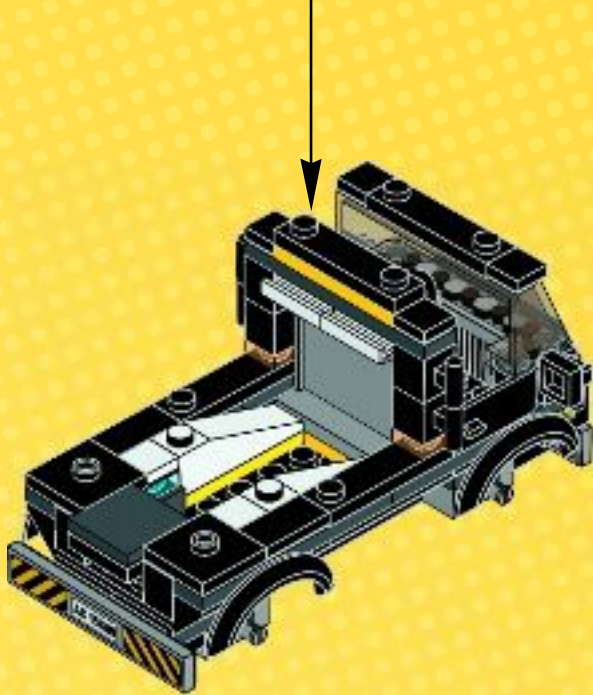
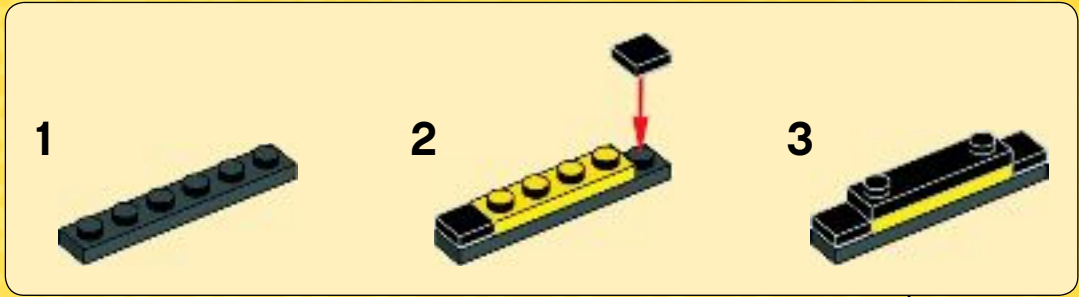



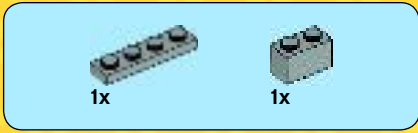
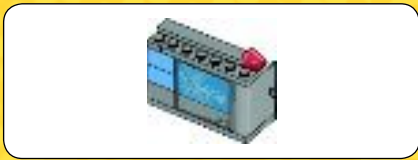

**1**

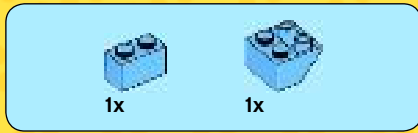
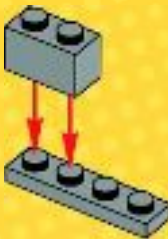

**2**

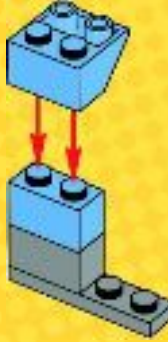

**3**

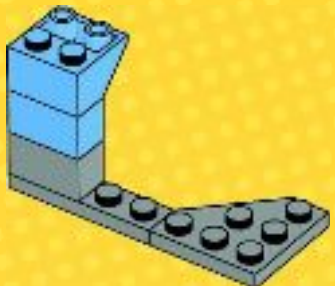

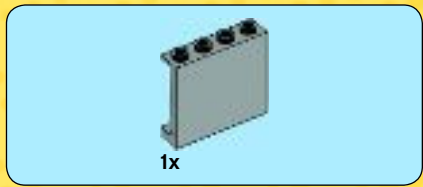

4

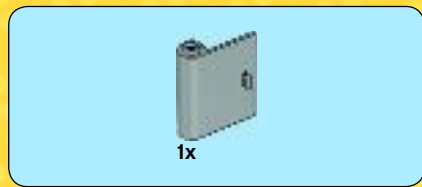
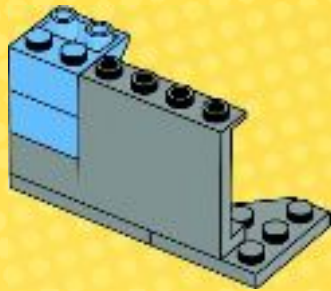

5

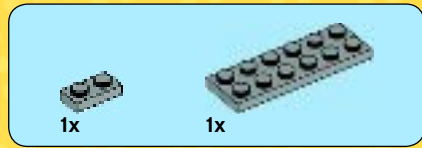
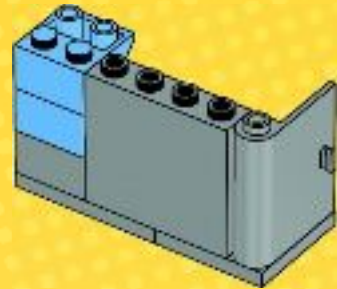

6

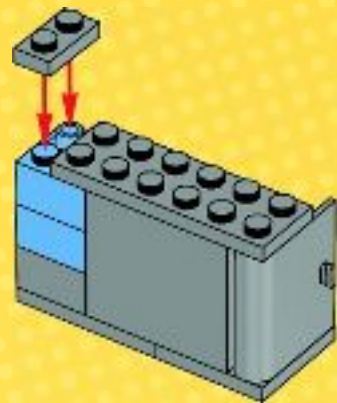

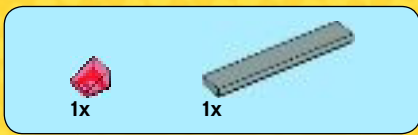

7



8

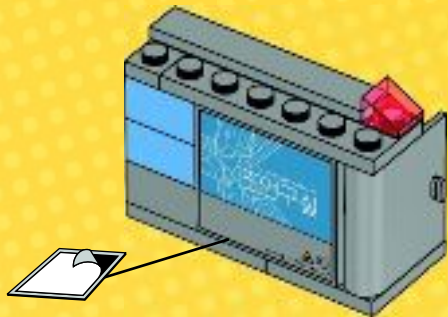

33

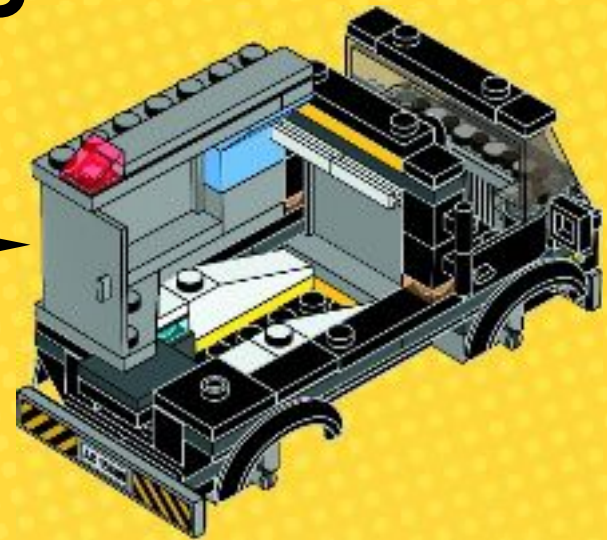



1

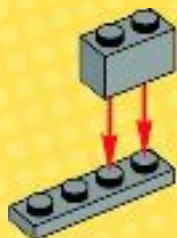

2

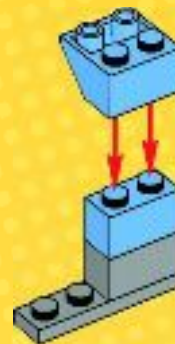

3

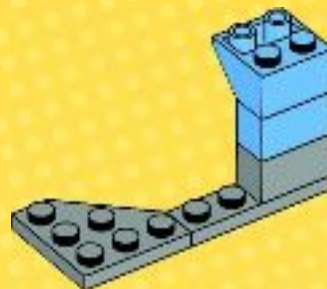

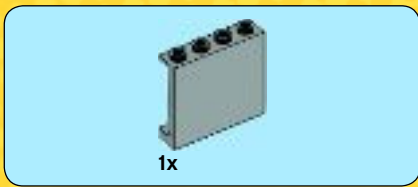

4

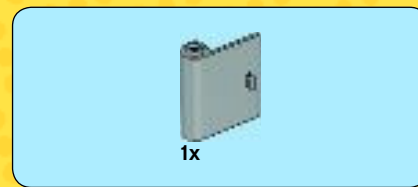
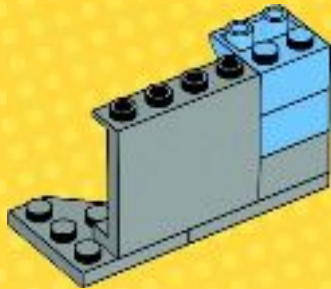

5

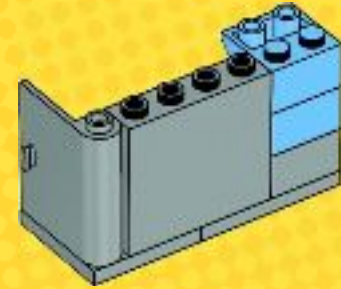

6

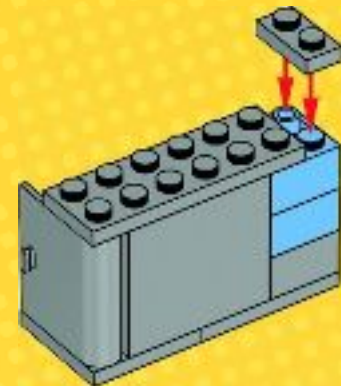

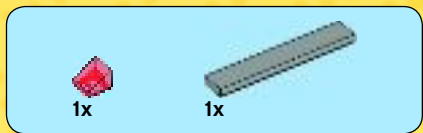

7

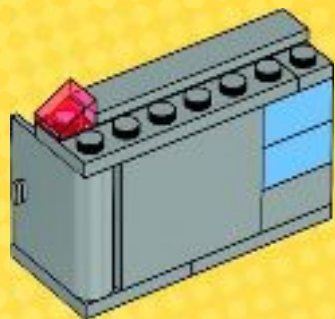

8

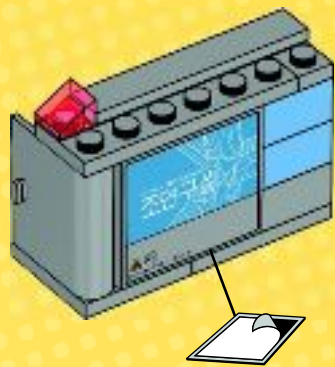

34

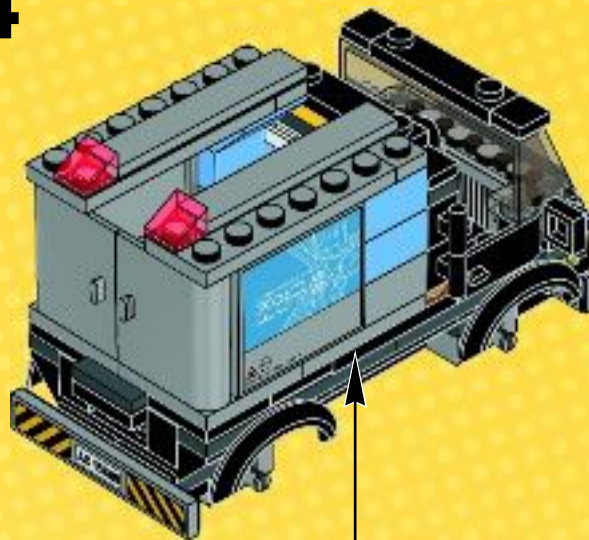



1x



1x

1



1x



1x

2



2x

3



1x



1x

4

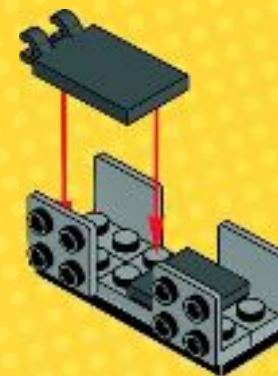



1x

5

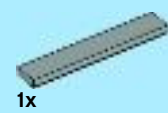
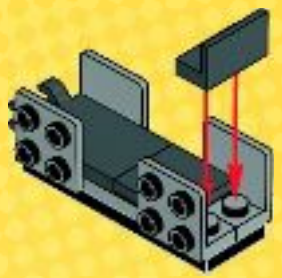

1x



1x



2x

6

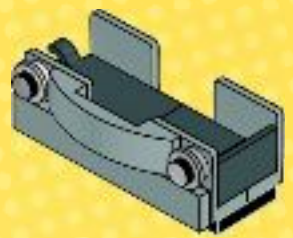

1x



1x



2x

7

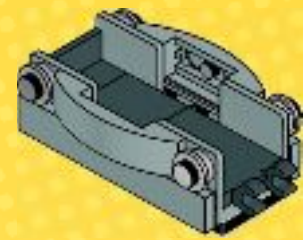



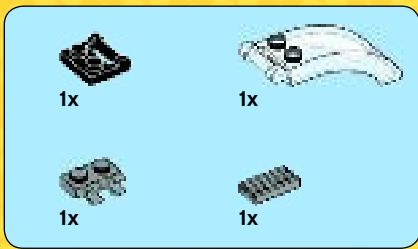

8

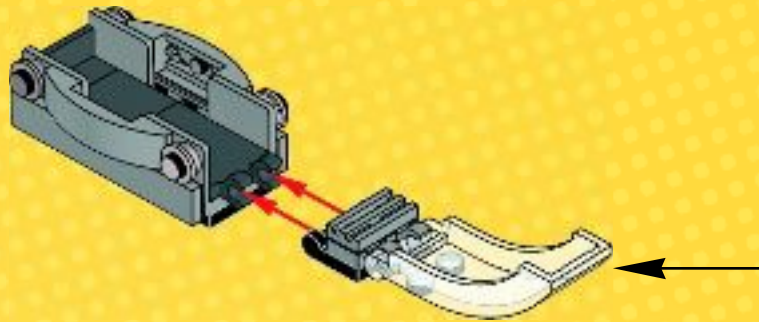
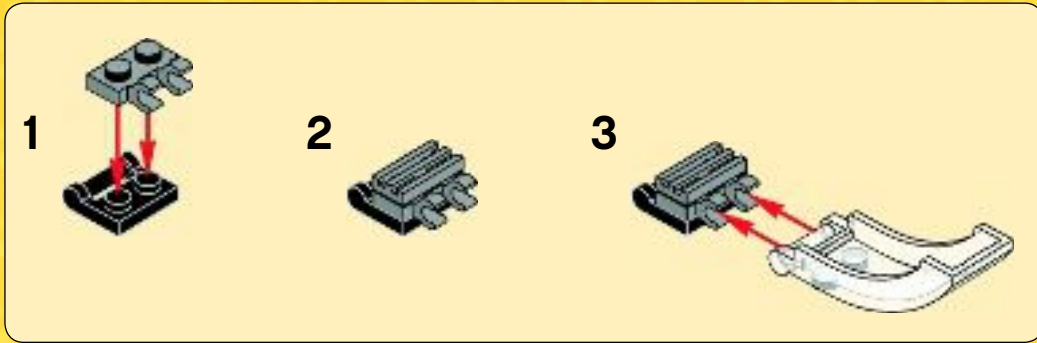

9

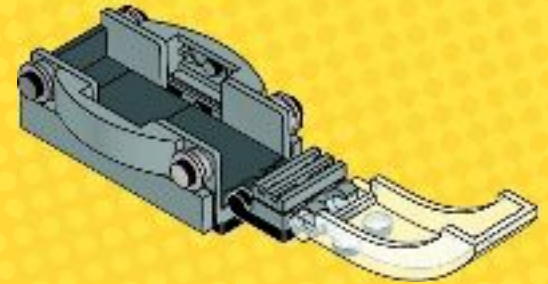

10



35

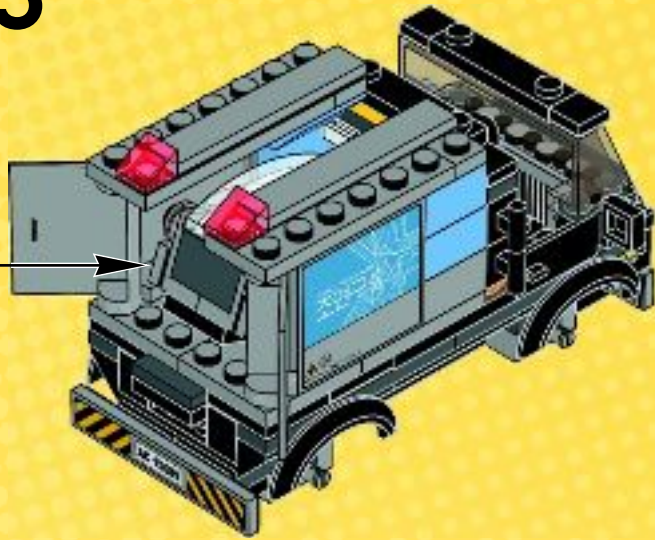

36

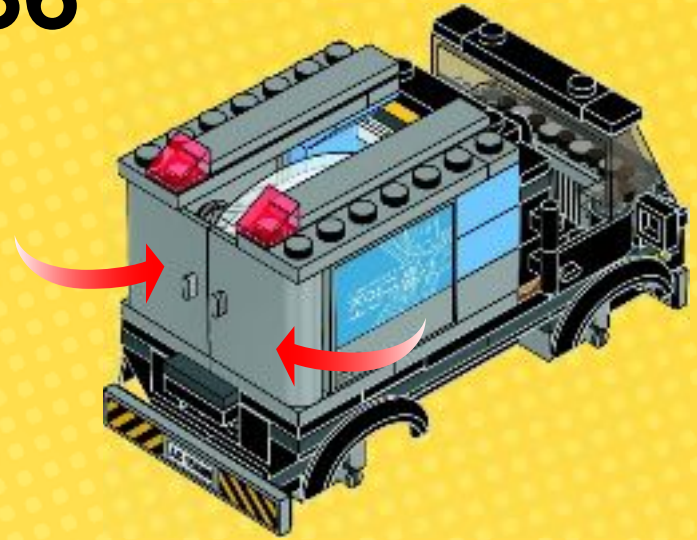

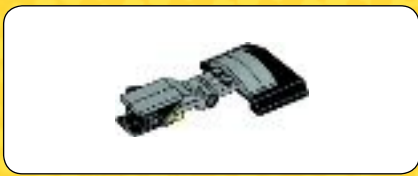

1



2

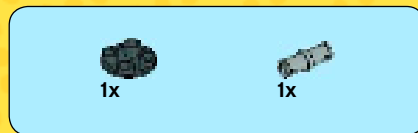

3



4

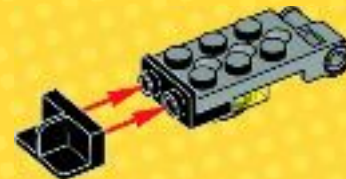



5

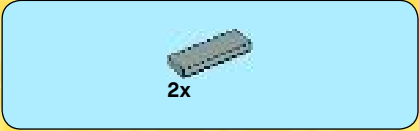

6

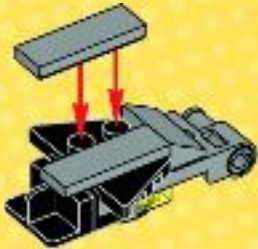

7

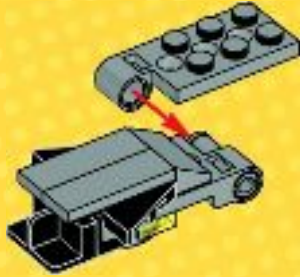

8





9

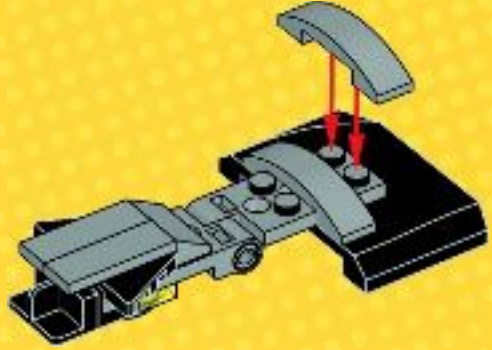

37





4x



4x

# 38



4x

1



2



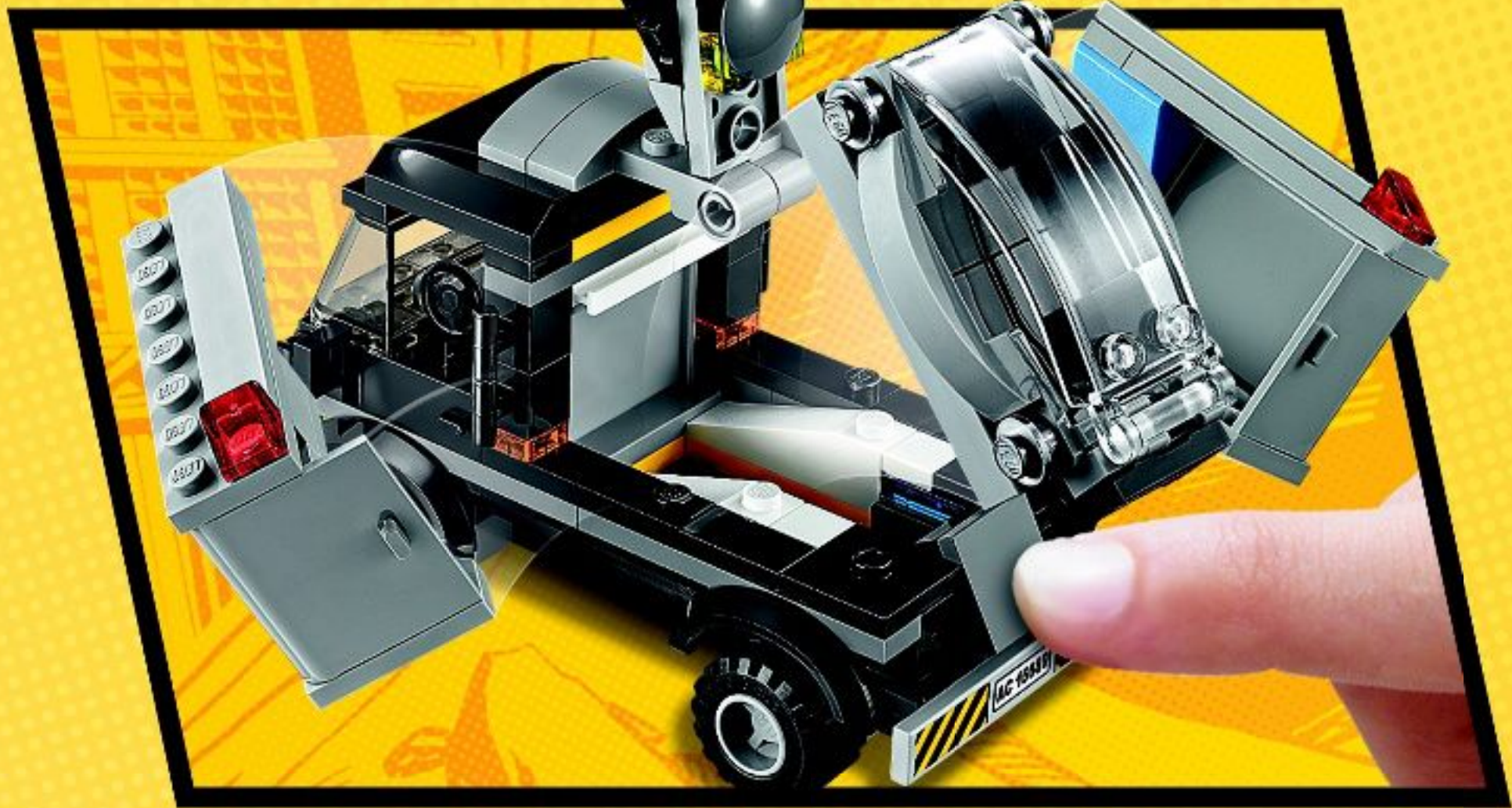

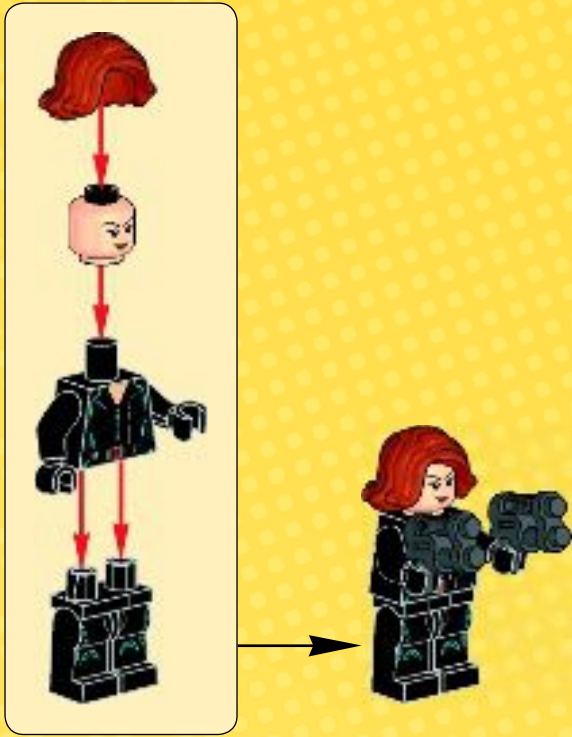
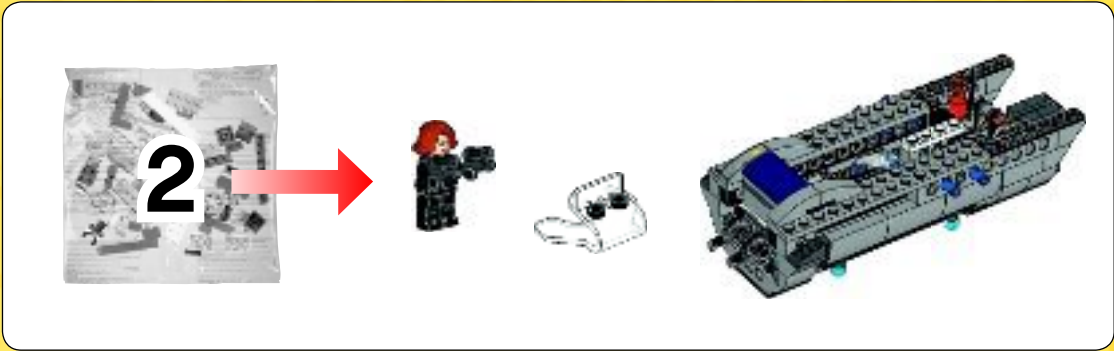



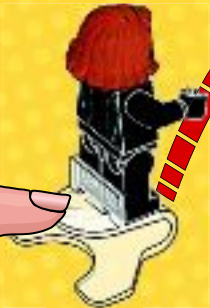
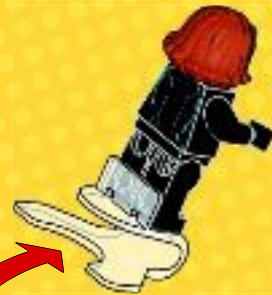

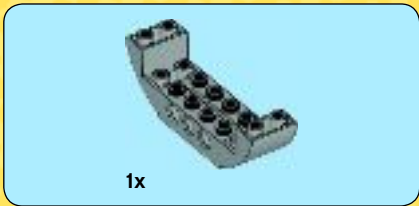
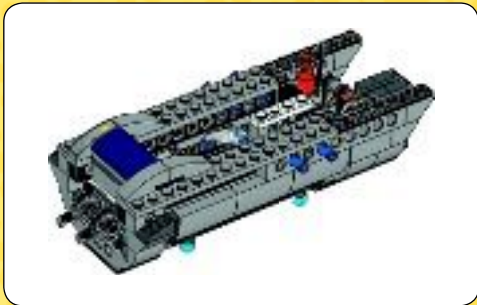
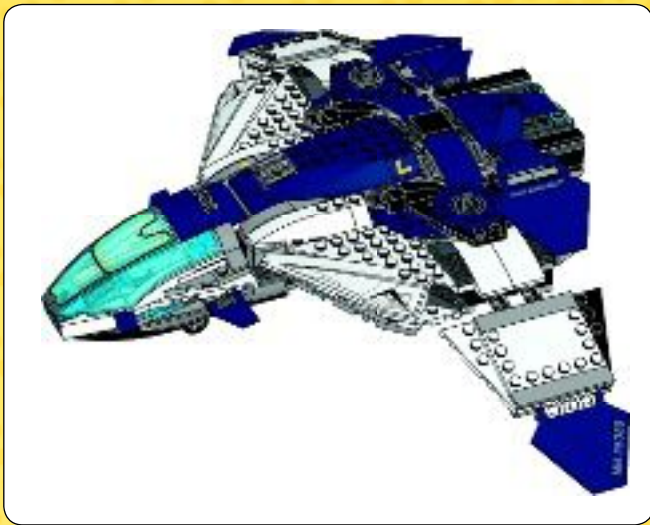

1x

1



2x

2

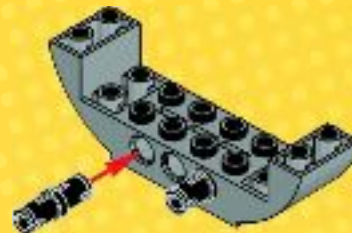

1x

3





4

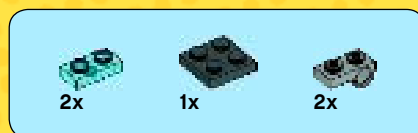
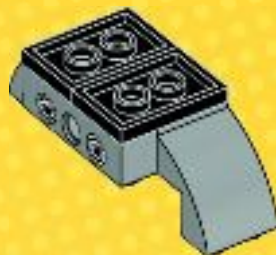

5



6



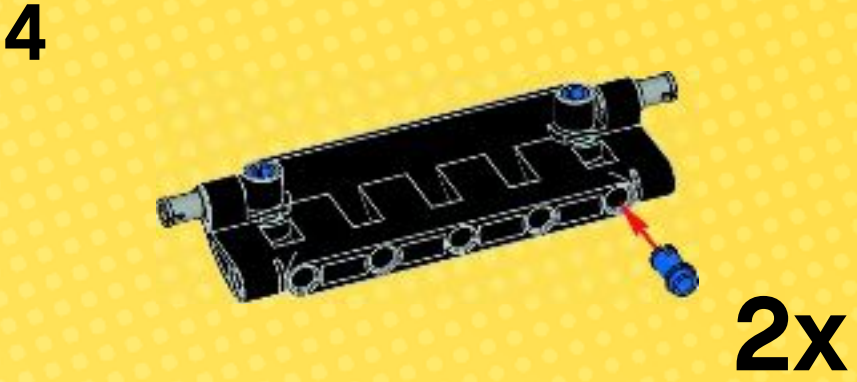
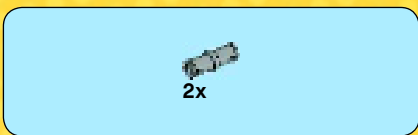
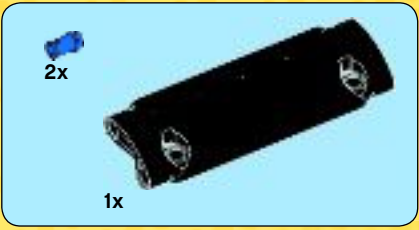
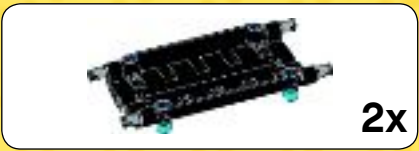



7

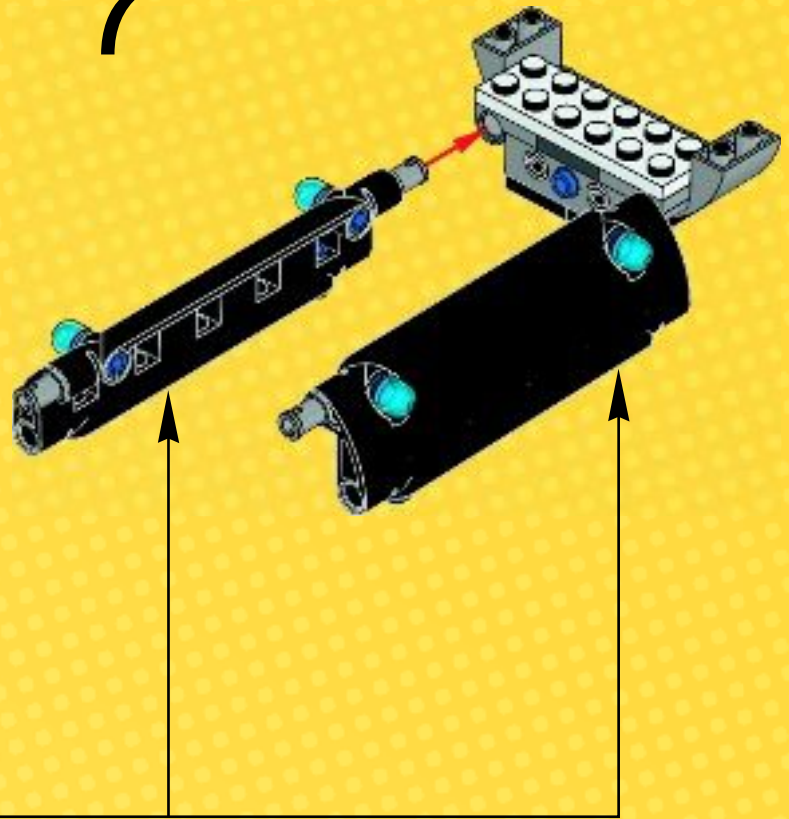

8

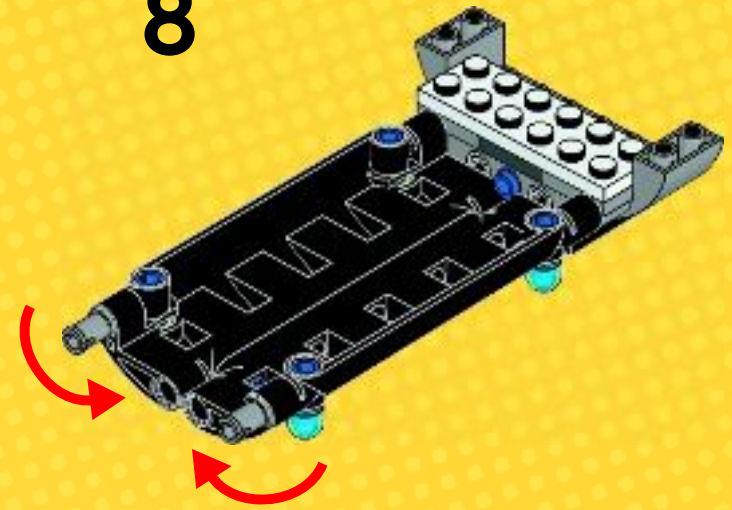

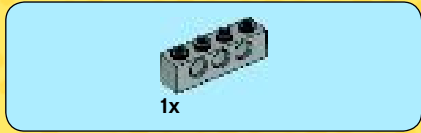

1

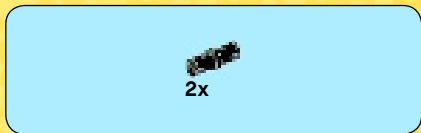

2



3

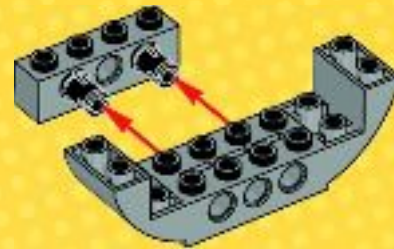

4



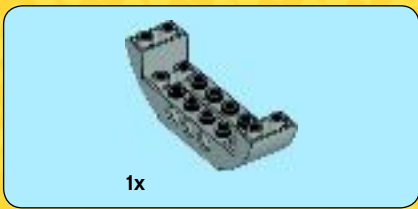

5



6

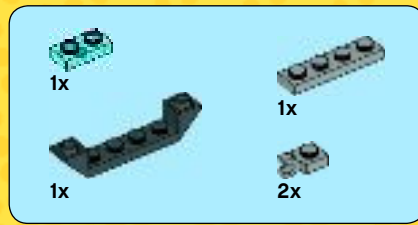
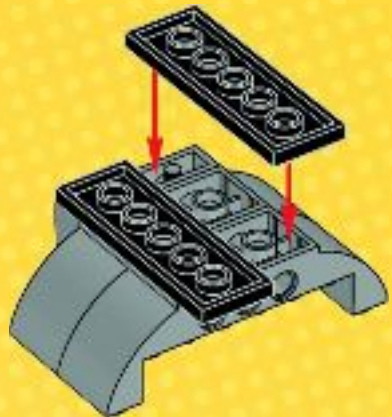

7

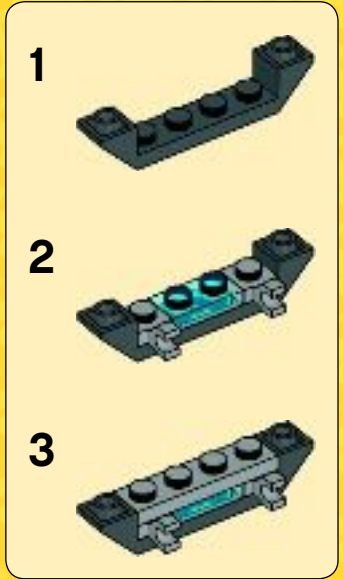



8

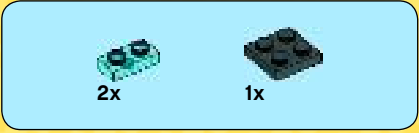

9

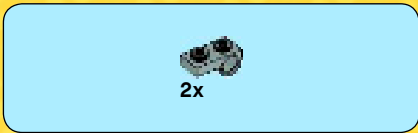

10



11

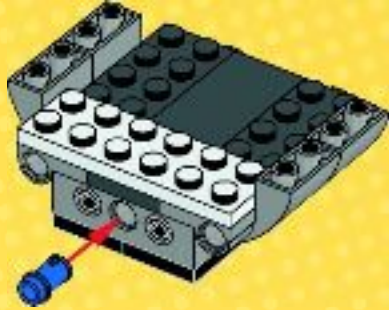



9

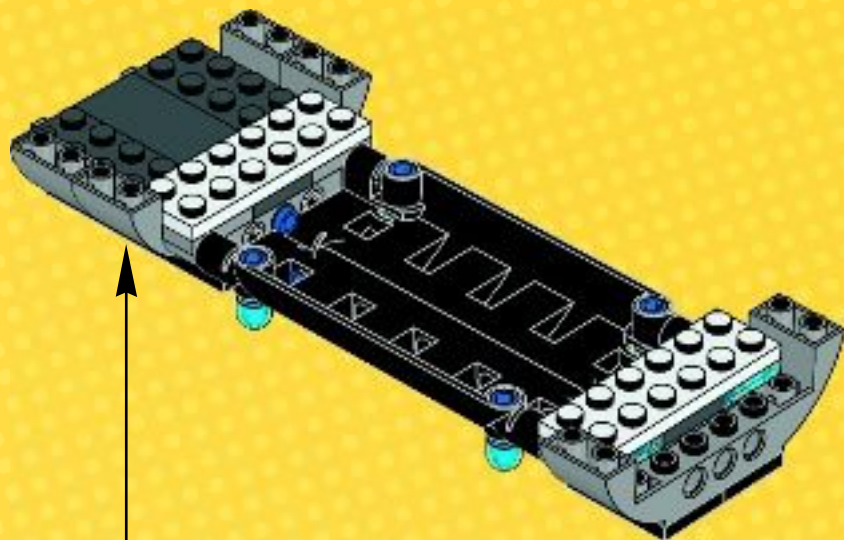
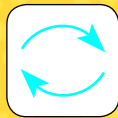

2x



2x



2x

10

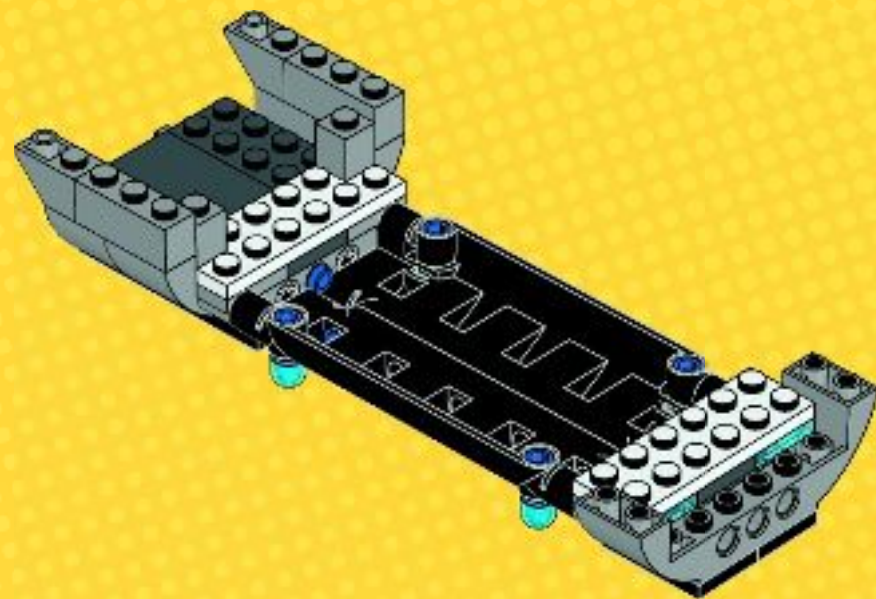

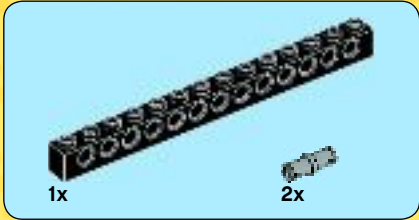

1



2

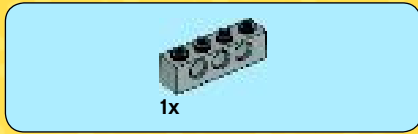
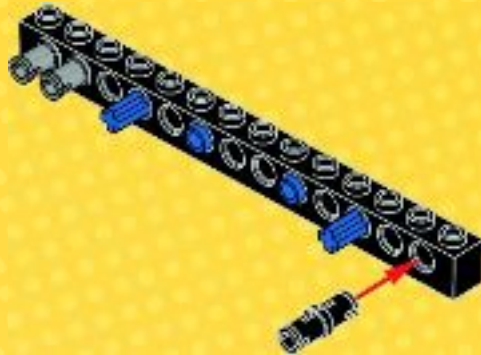

3



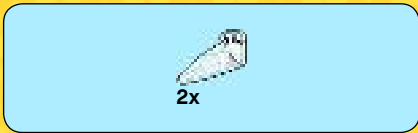

4

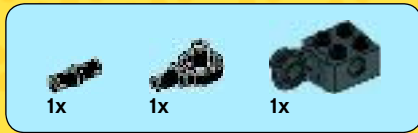

5

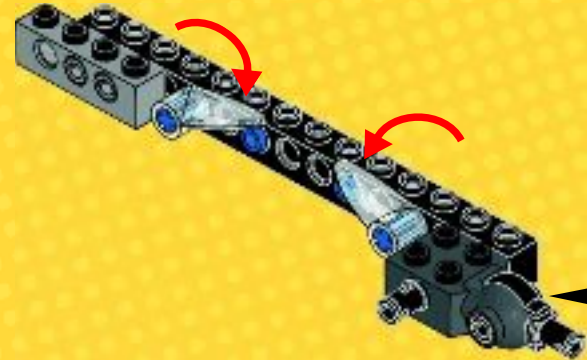



1



2



3

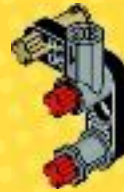

4



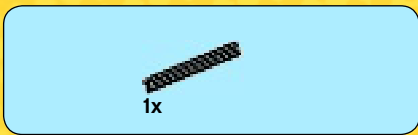

5



6

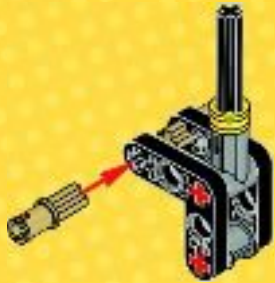

7

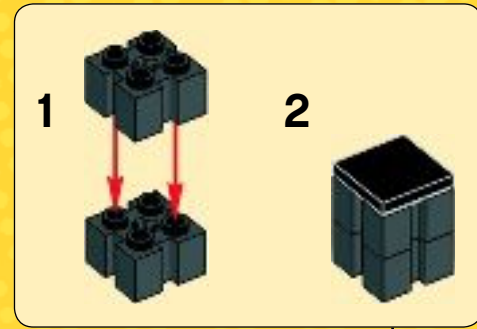

6

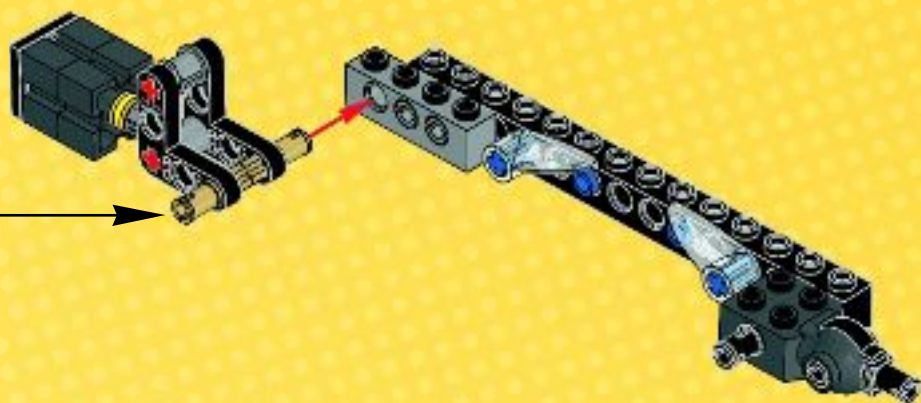

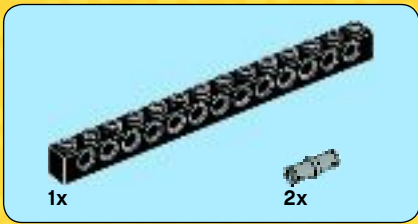

1



2

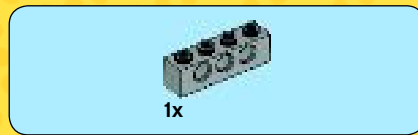
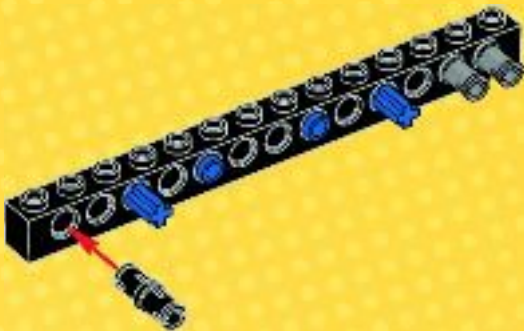

3

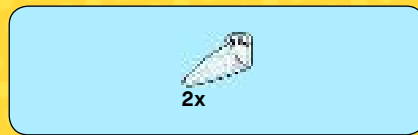

4





5

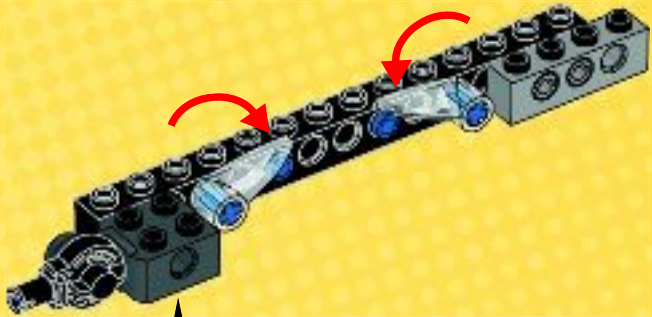

7

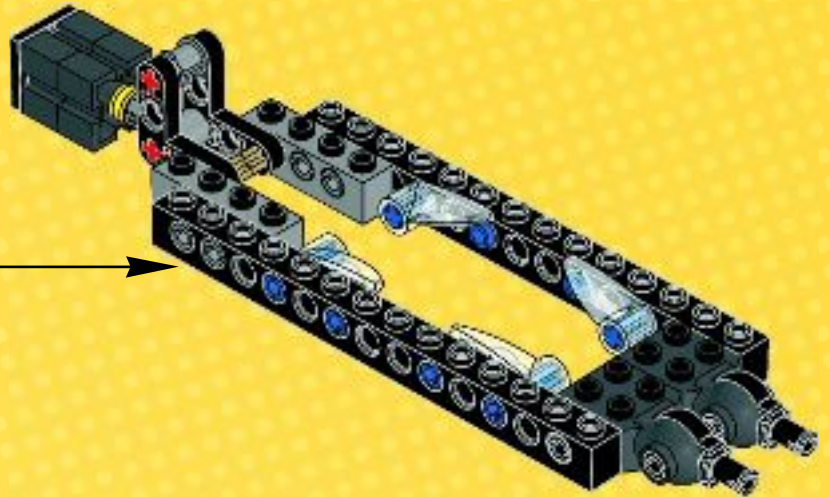



# 11

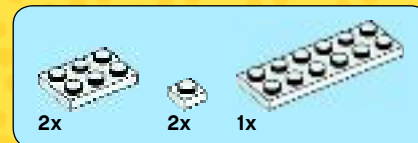
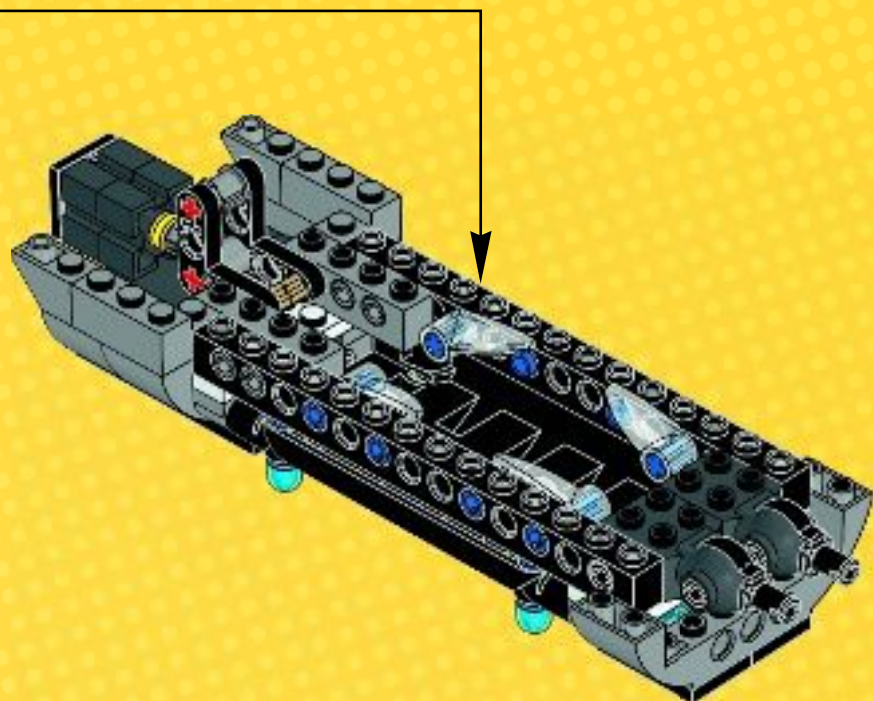

# 12

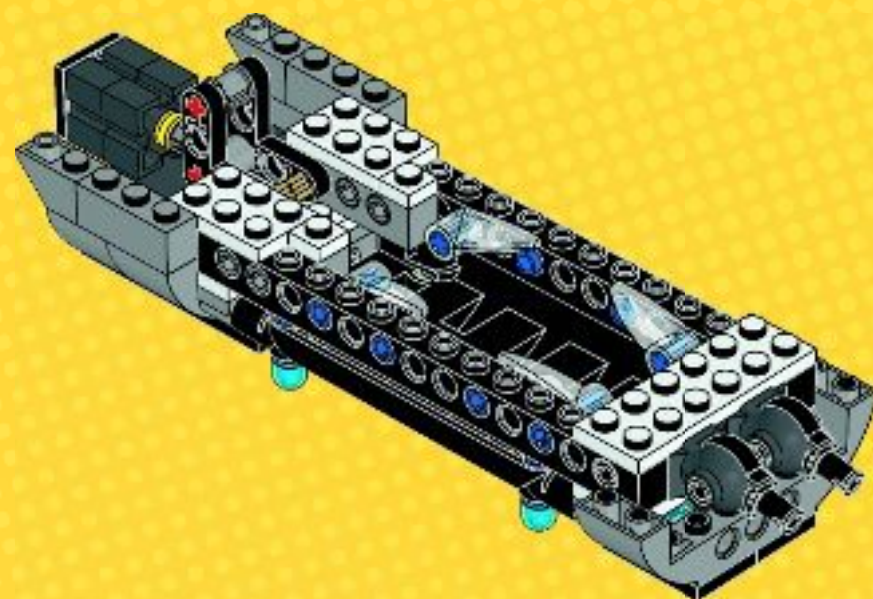



6x

# 13

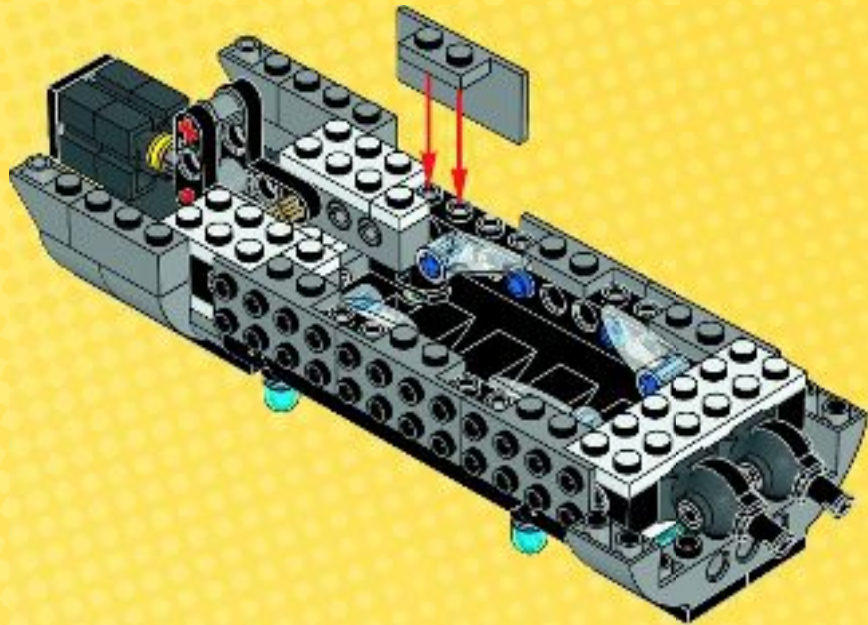

1x

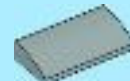

3x

# 14



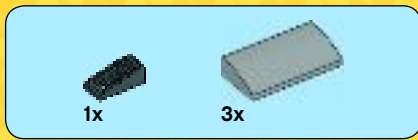

15

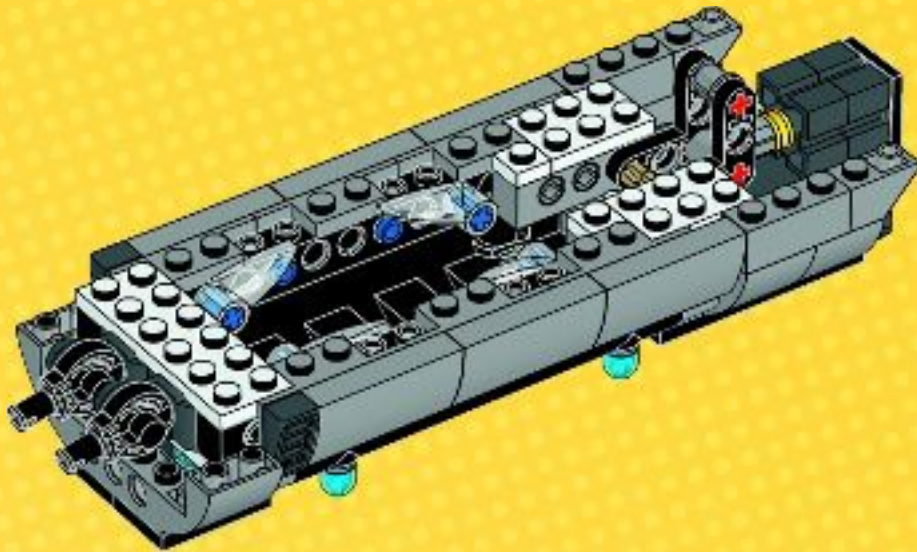
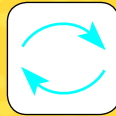

16

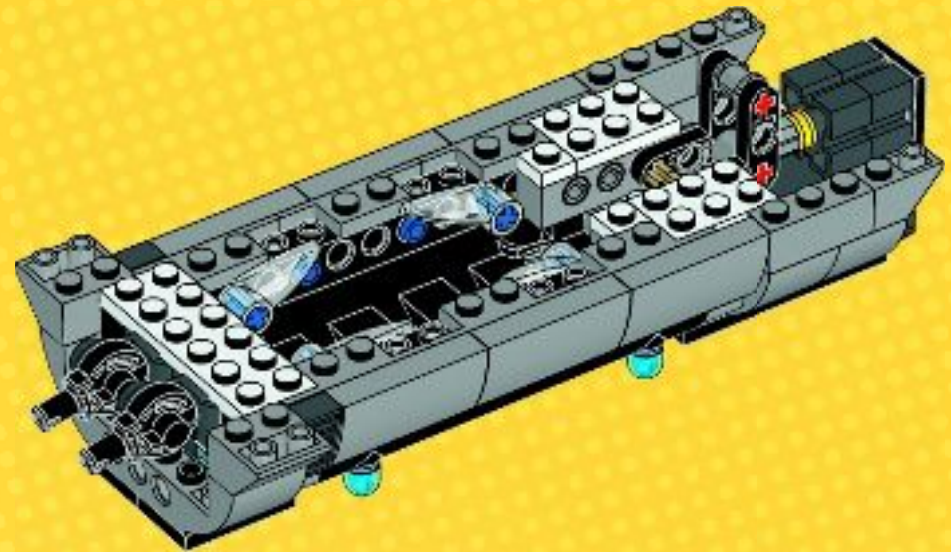

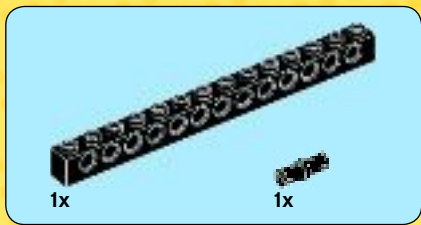

1

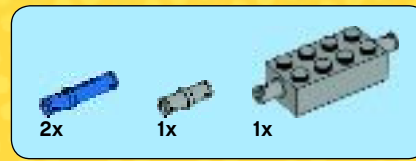
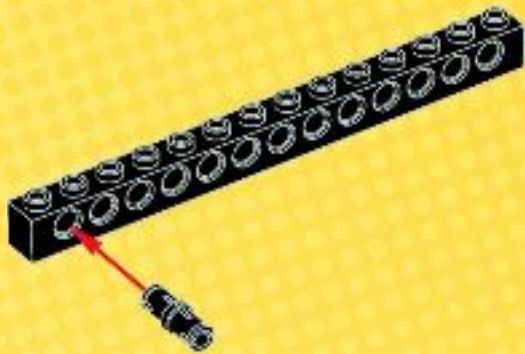

2

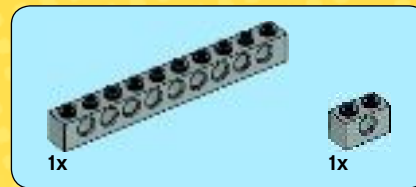

3

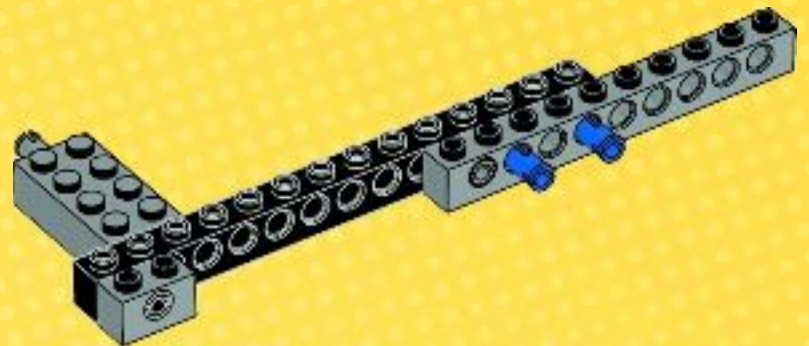

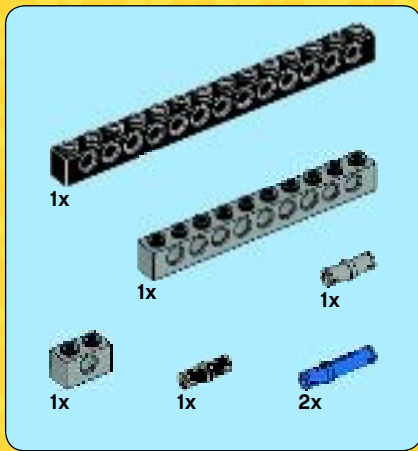

4

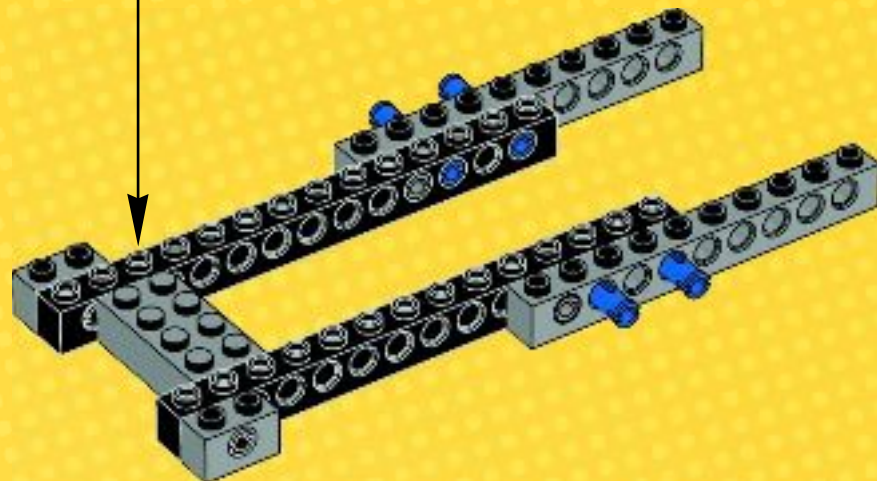
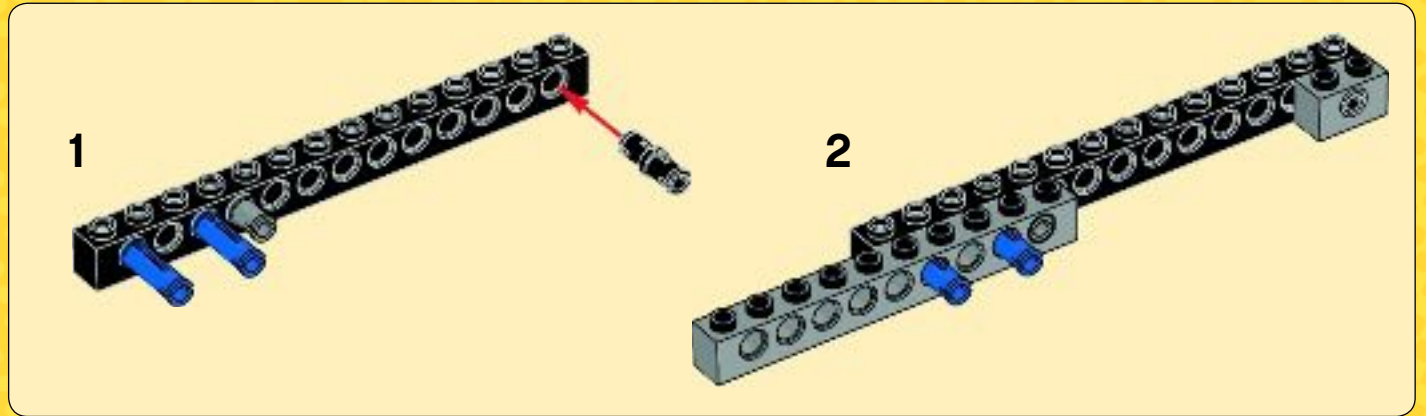

17

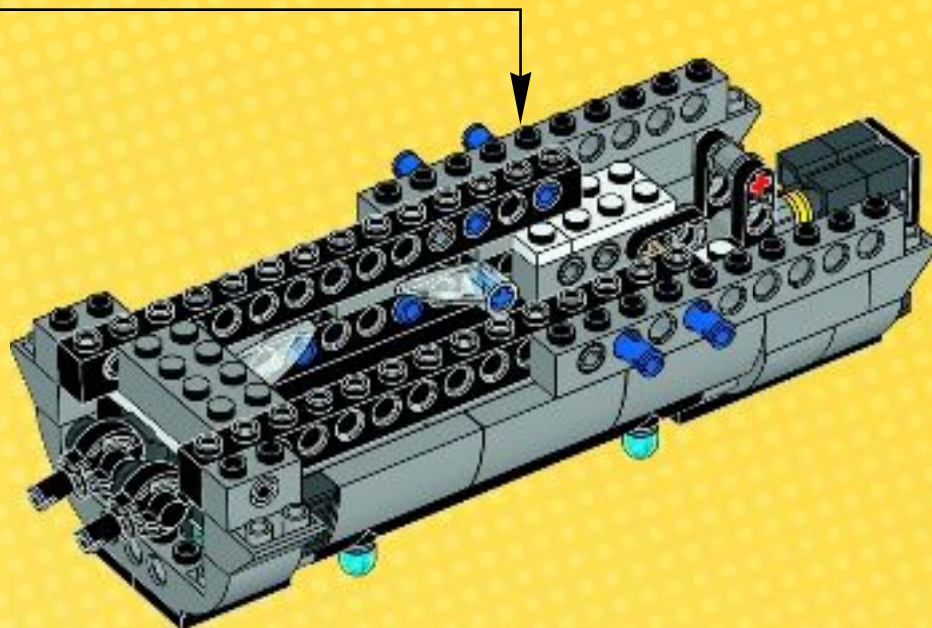



2x

# 18

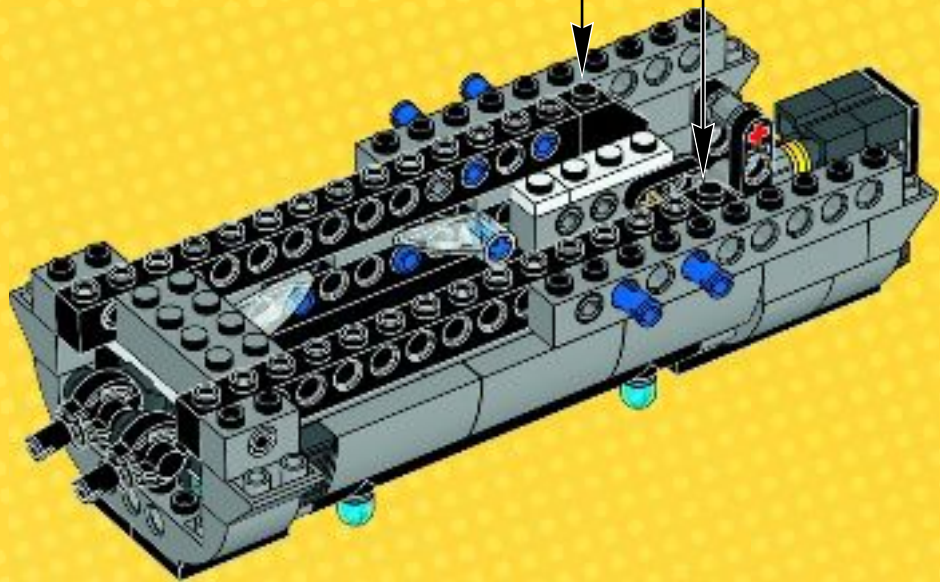



2x



2x

# 19

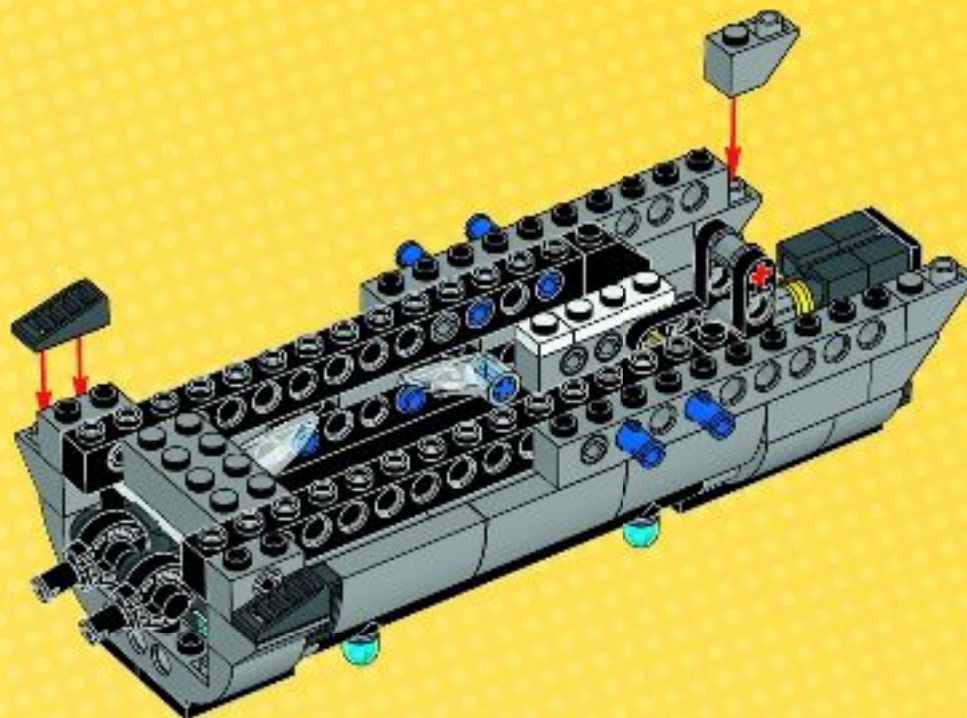





2x



2x



4x

# 20

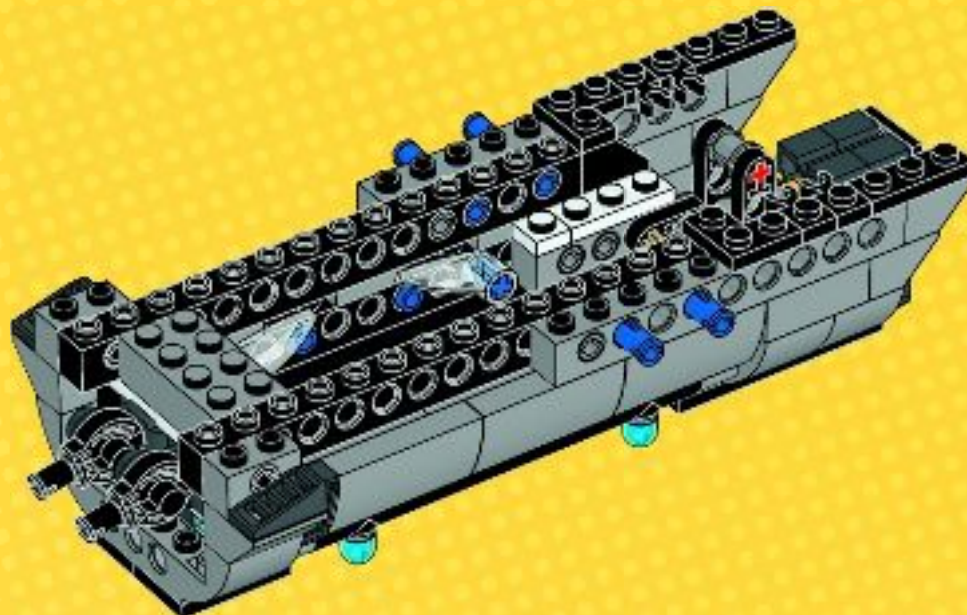

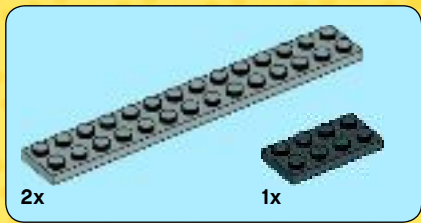

21

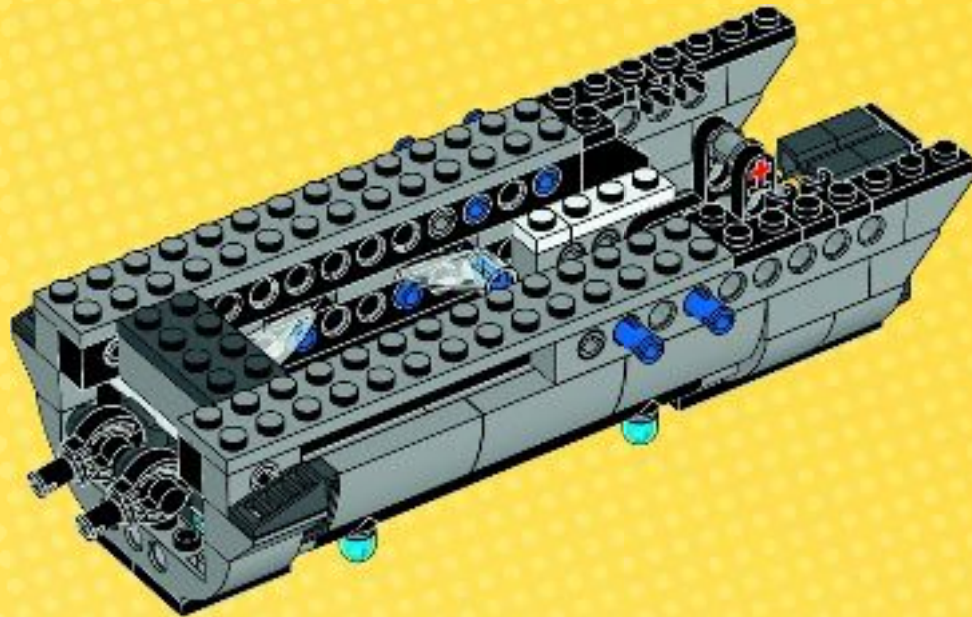

1x 2x 1x

22

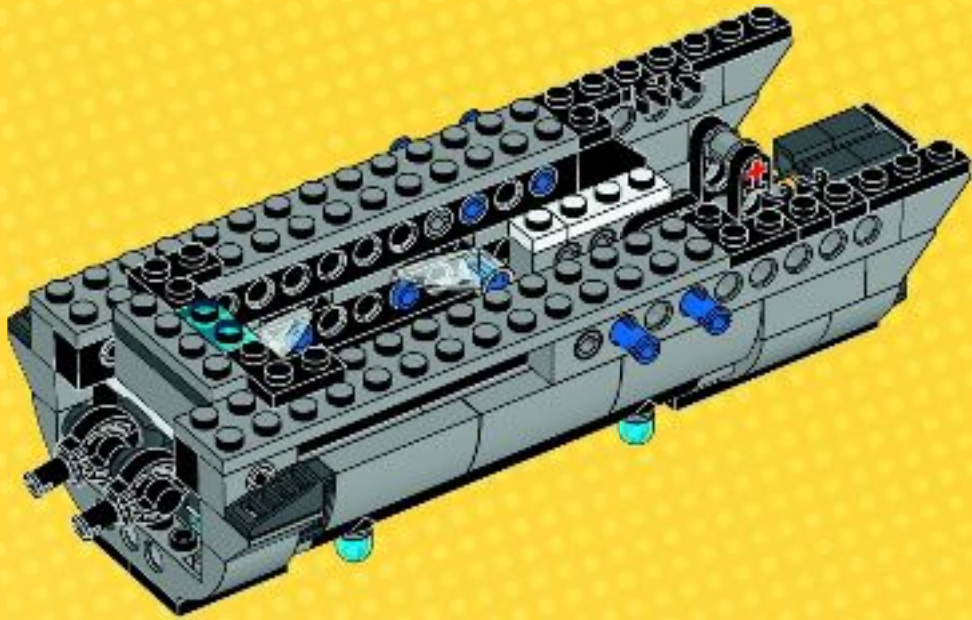



4x

# 23

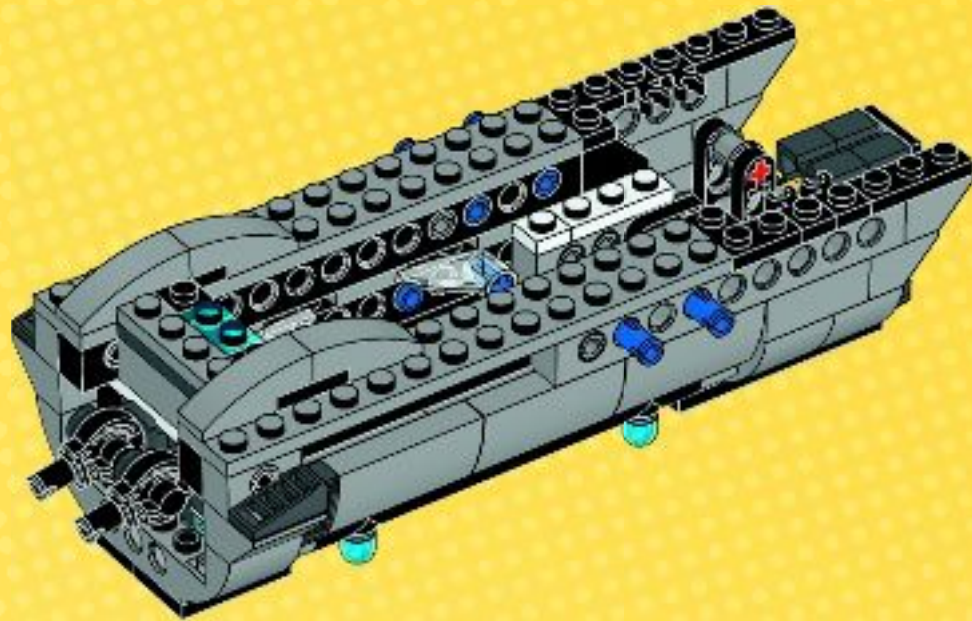

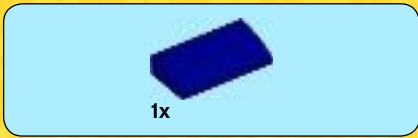

24

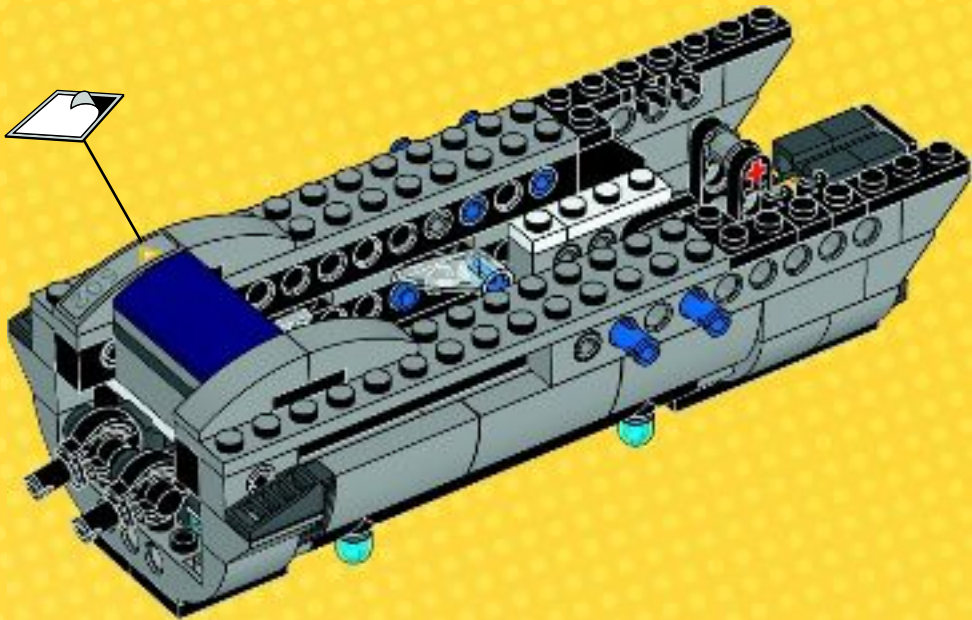

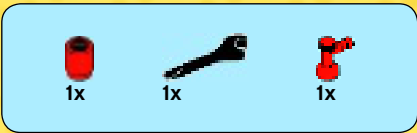

# 25

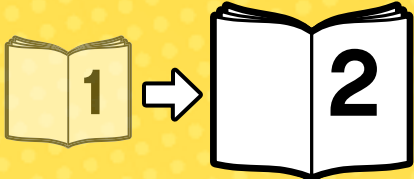
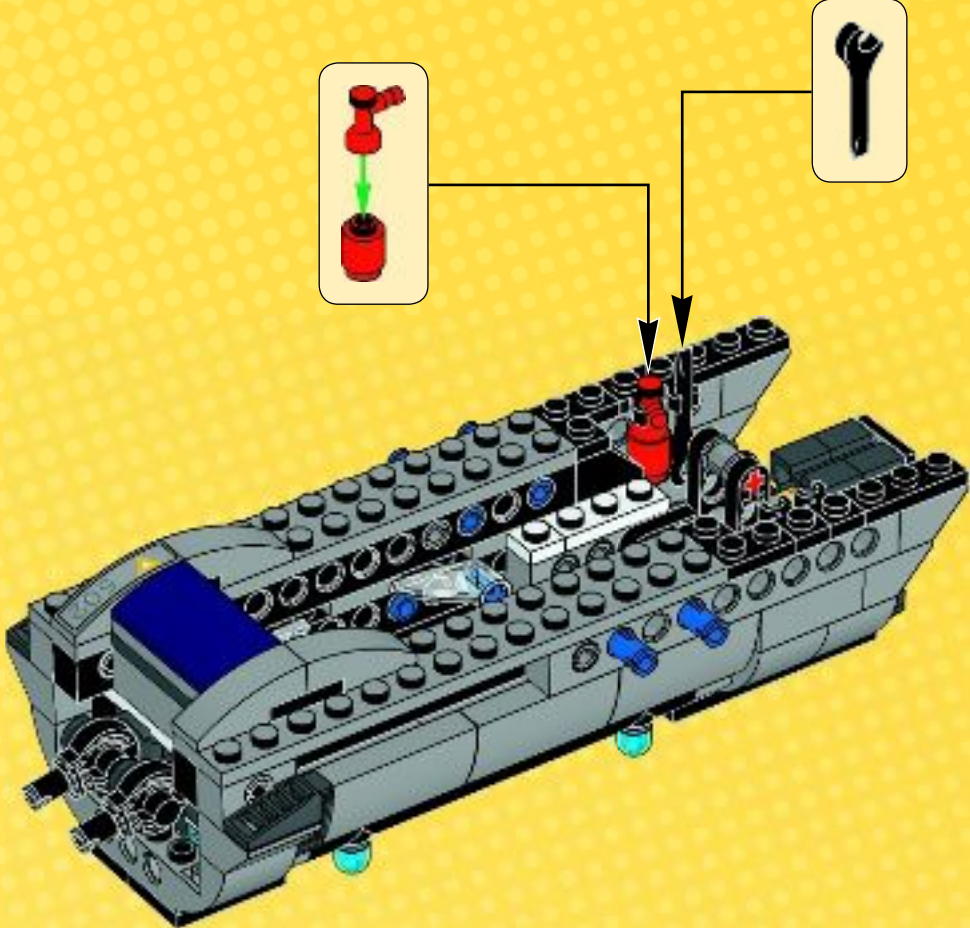



# club™

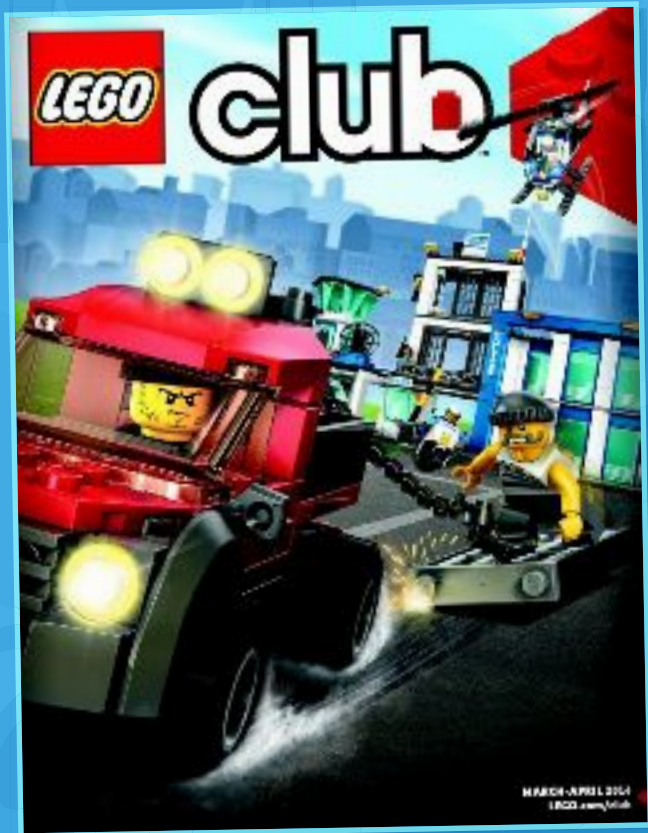



# CITY



**LEGO.COM/CITY**



60069



60068



60067



60066



60065





**LEGO**

**MARVEL**  
**SUPER**  
**HEROES**



76032



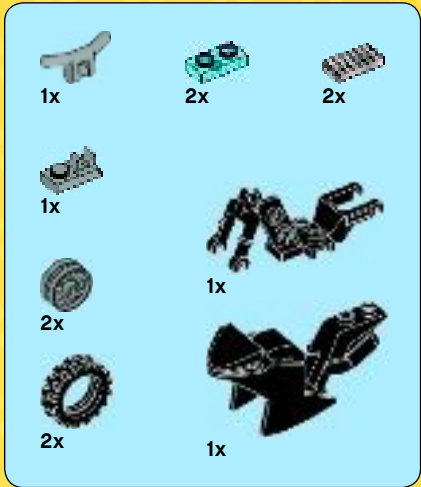
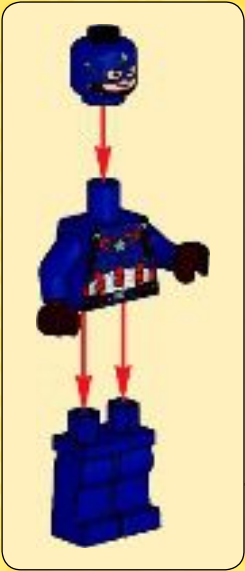

3



4



5



6

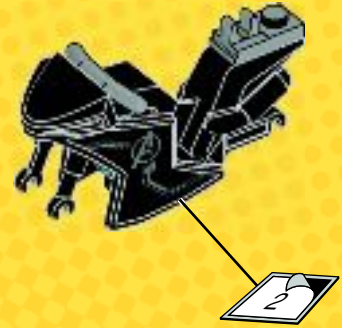

7

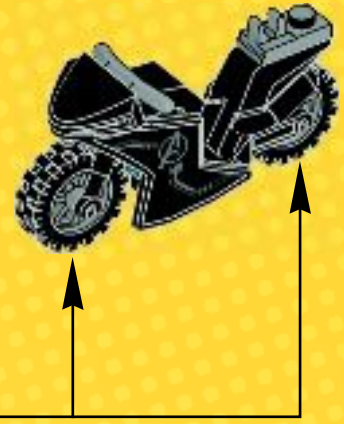

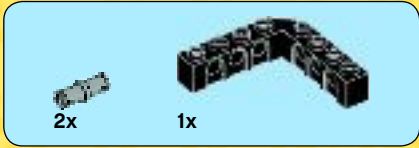

1



2



3





1x

4



1x

5



1x

3x

6



1x



1x

7



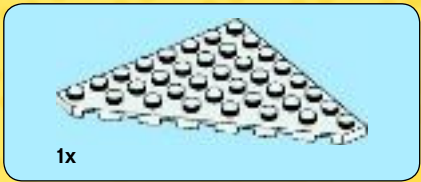

8

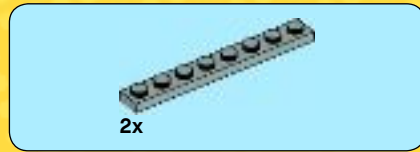

9

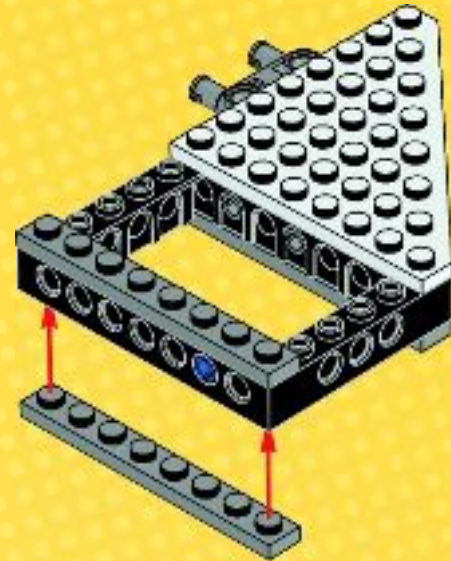
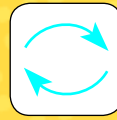

2x

2x

# 10

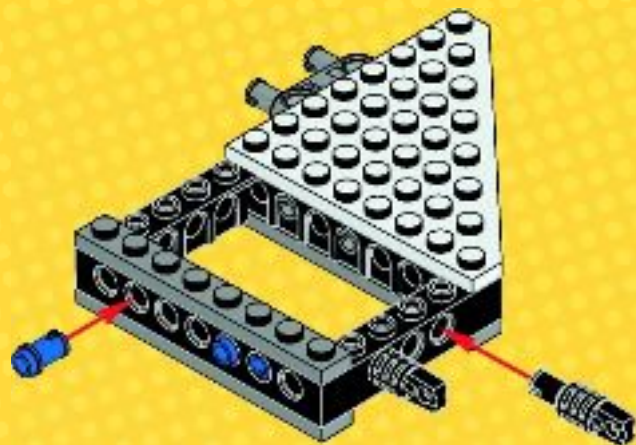

2x

# 11

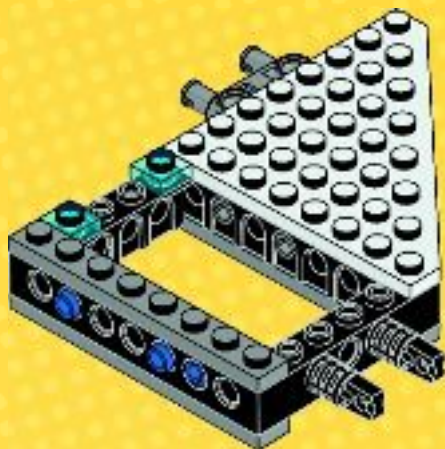

1x

1x

# 12

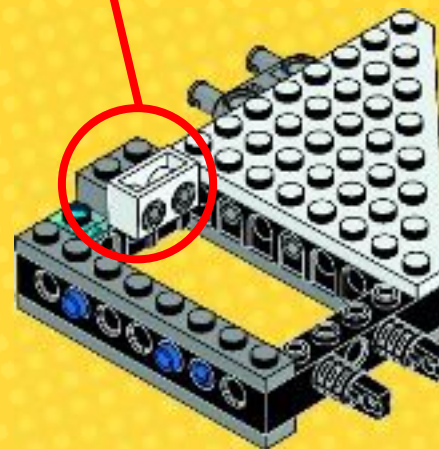
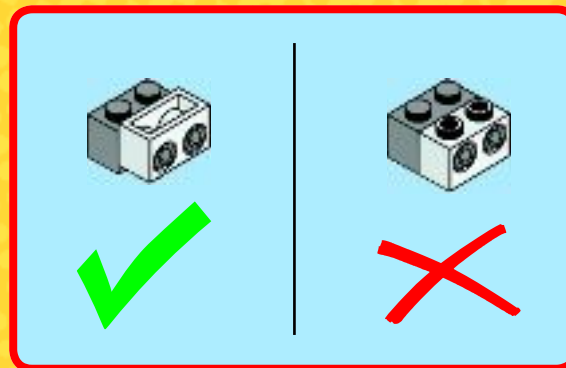

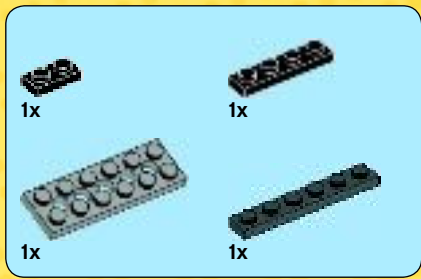

13



14

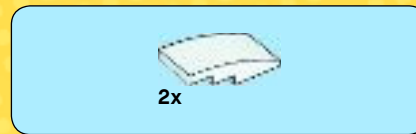
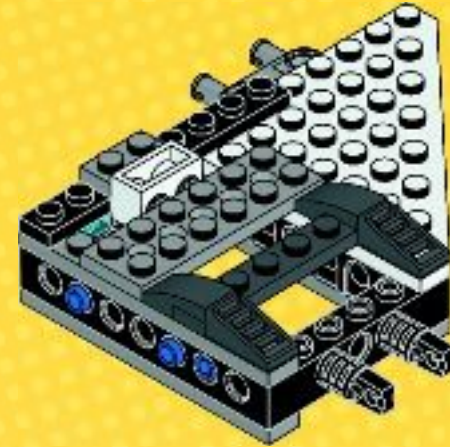

15







16

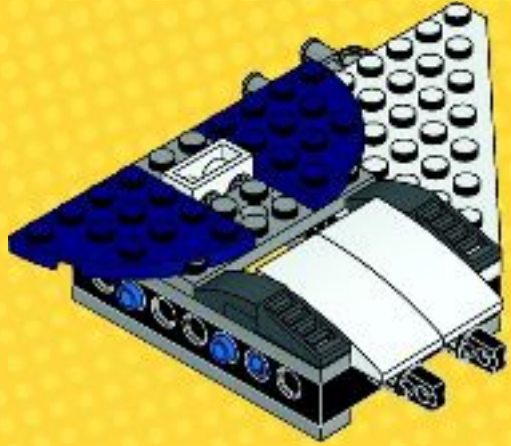

18



17

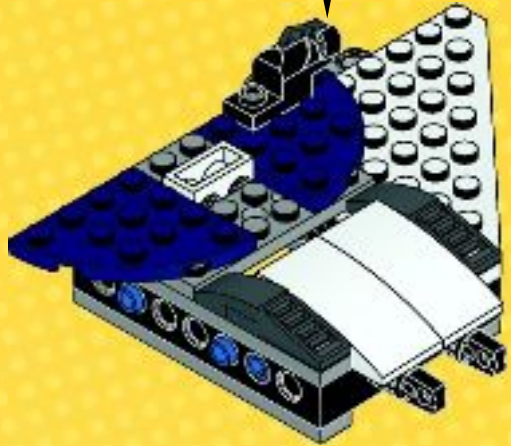
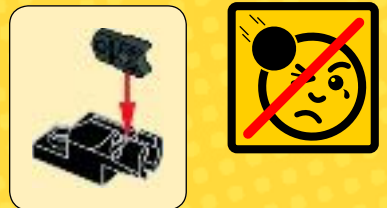

19





# 20

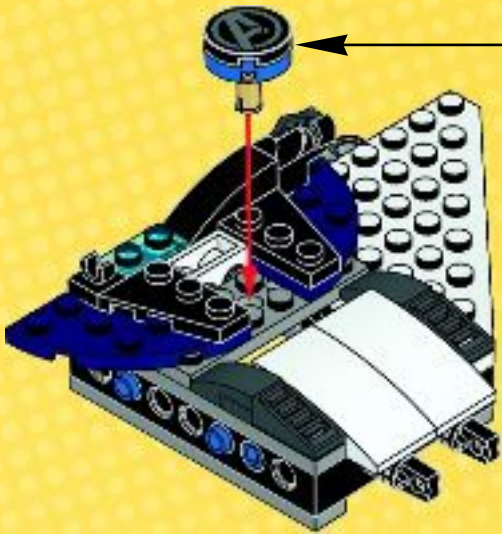
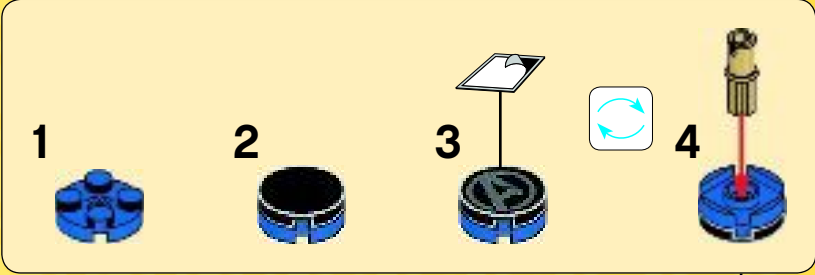

# 21



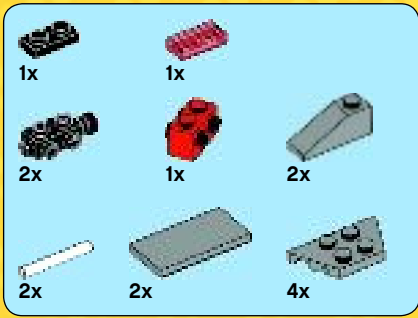

22

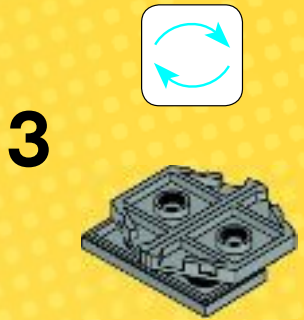

4



5



6



7

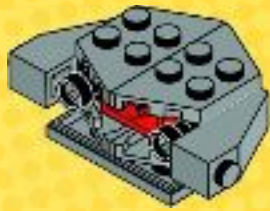

8

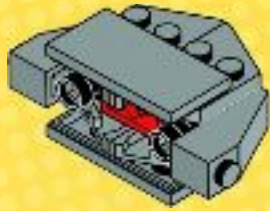

9

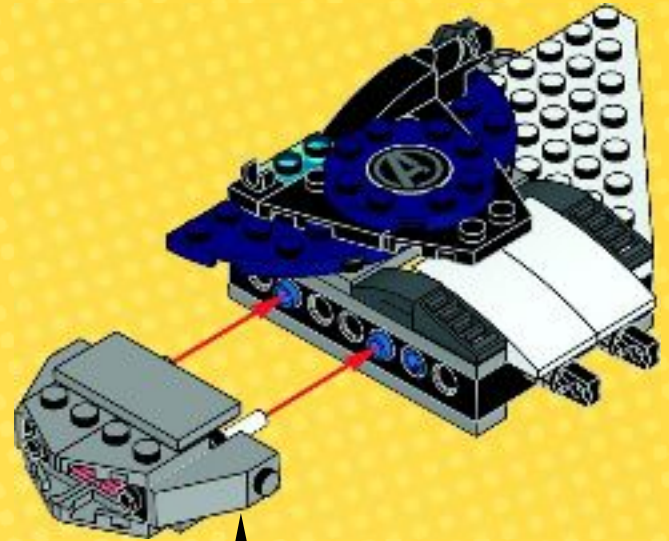
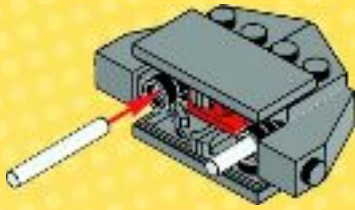

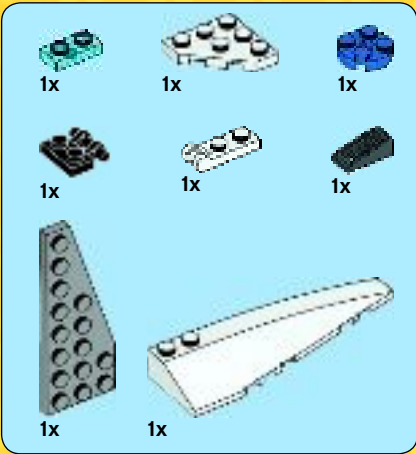

23

1



2



3

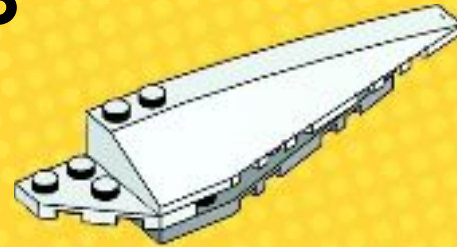

4

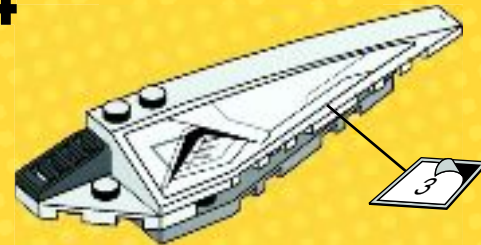



# 24

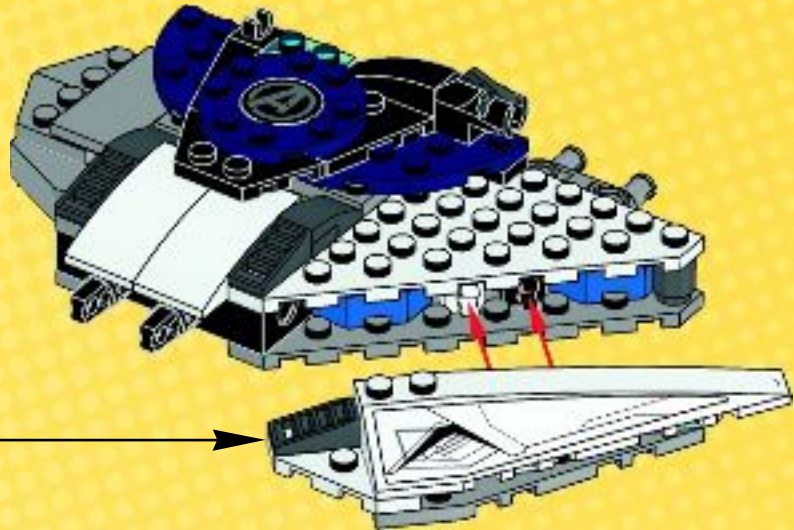
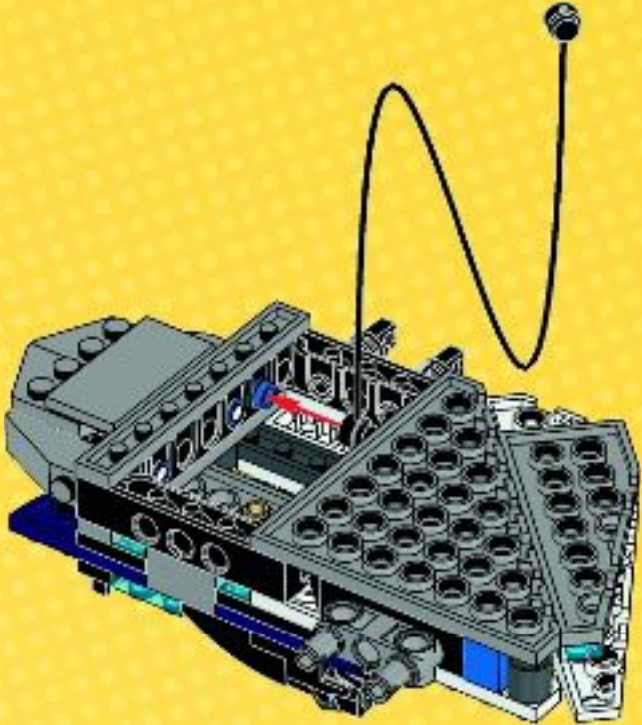



26



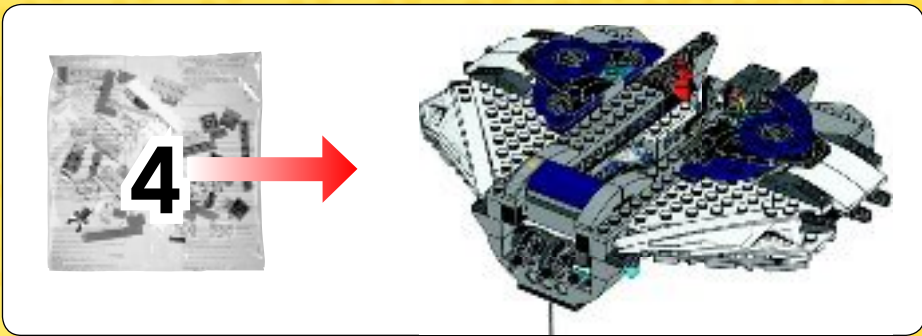

27

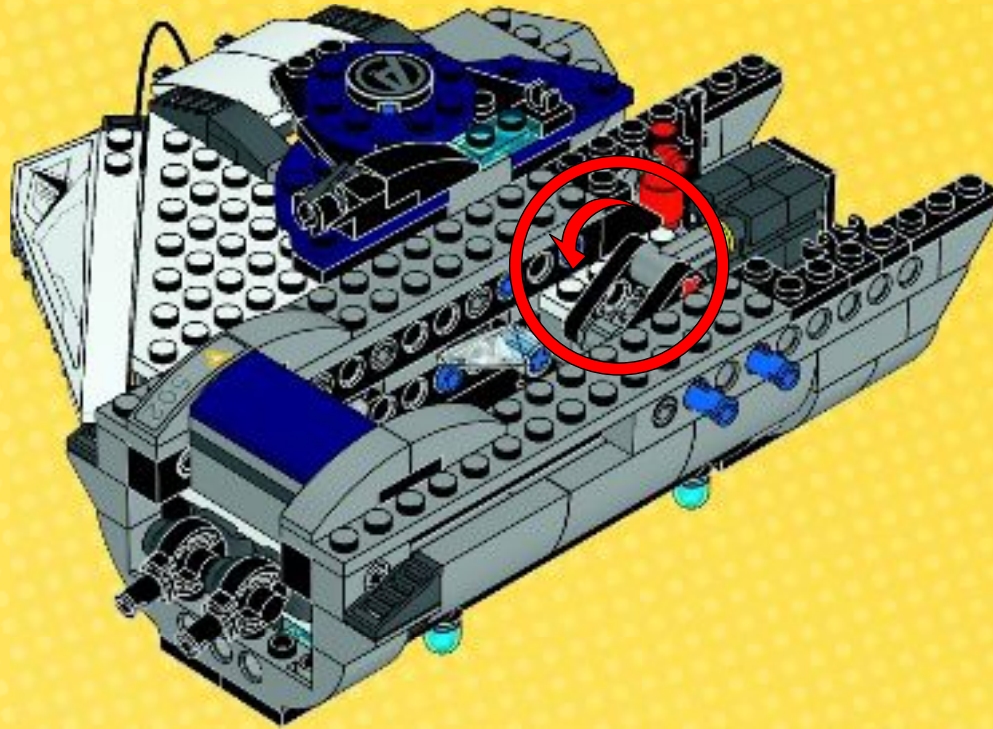



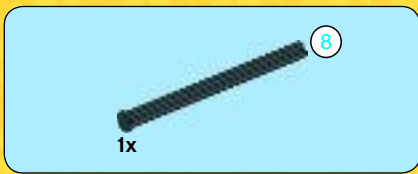

28

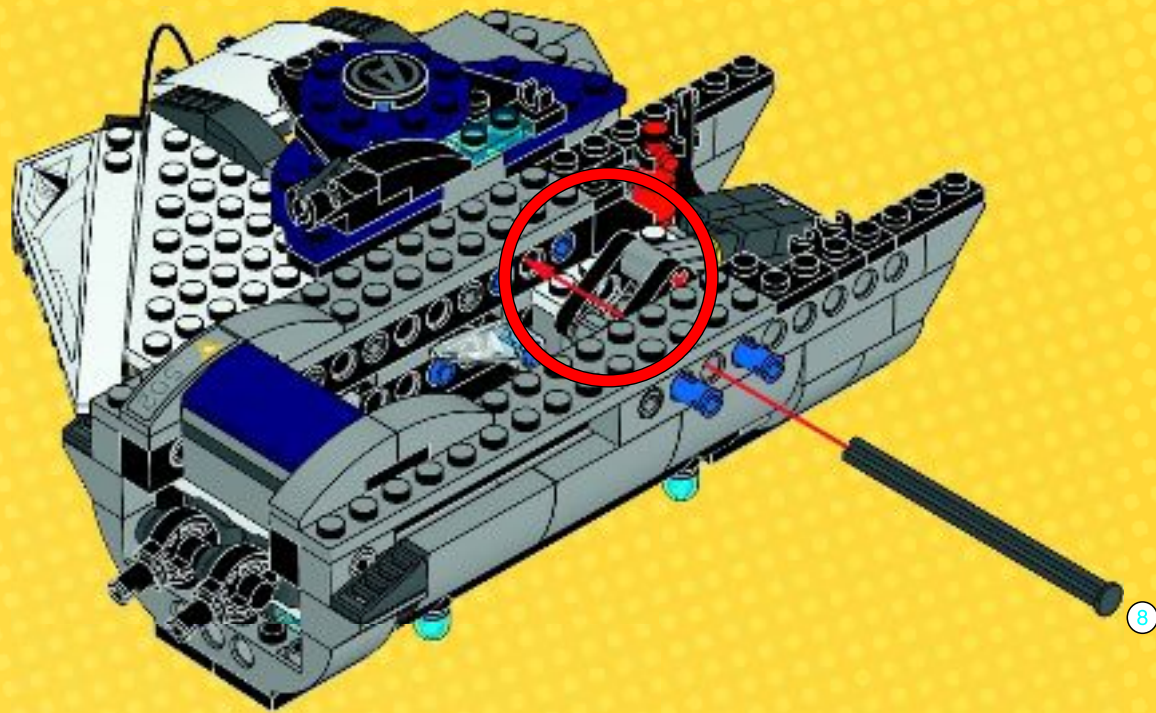

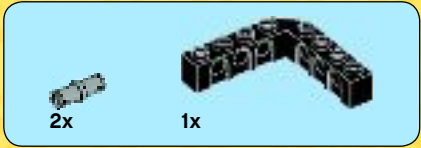

1

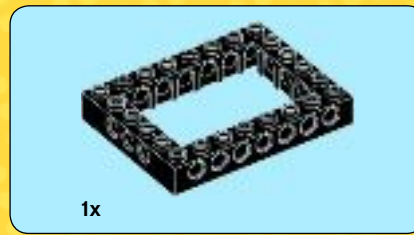

2

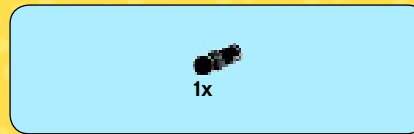

3

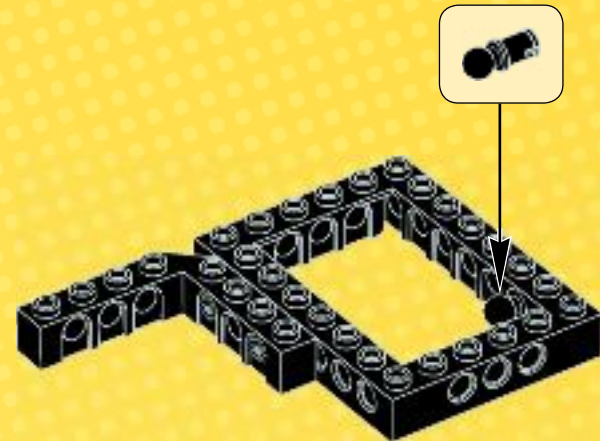



1x

4



1x



3x

6



1x

5



1x



1x

7



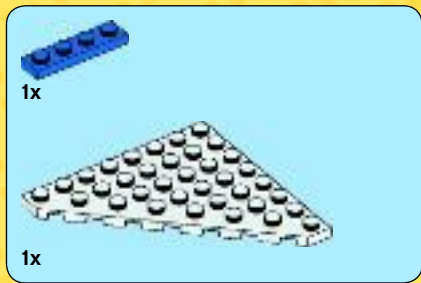

8

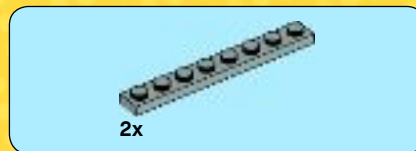
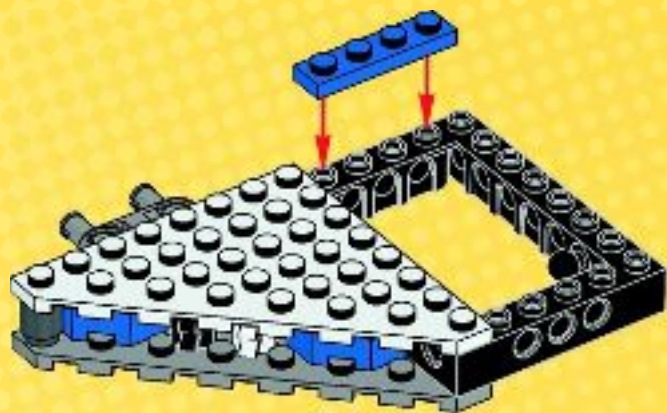

9

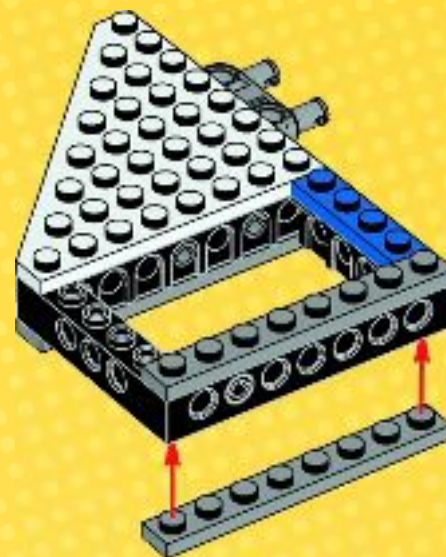
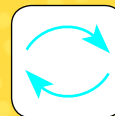

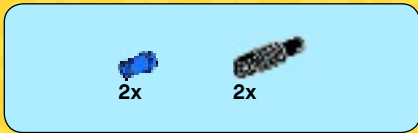

10

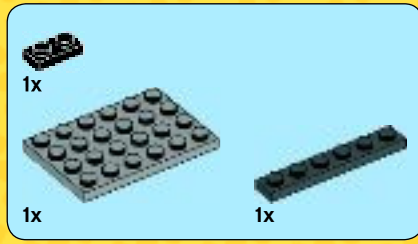
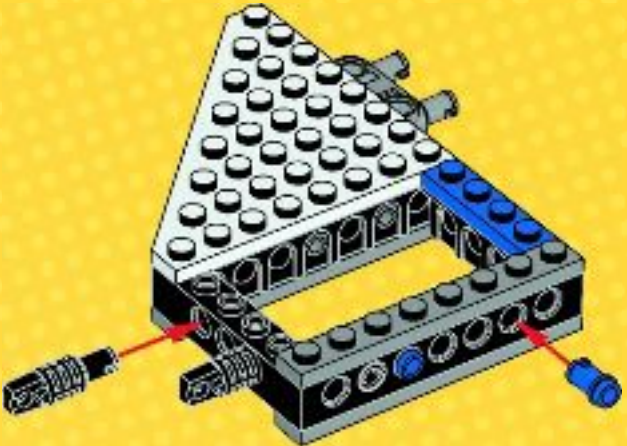

11



12





1x



1x

# 13

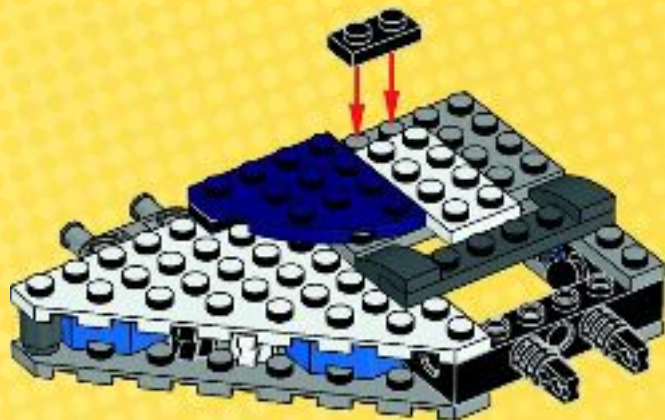

2x



1x

# 14

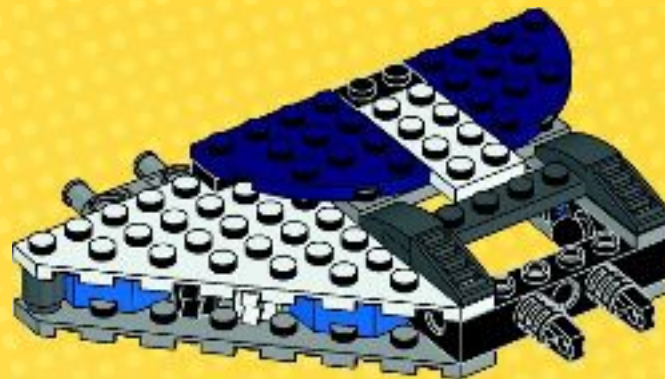

2x

# 15

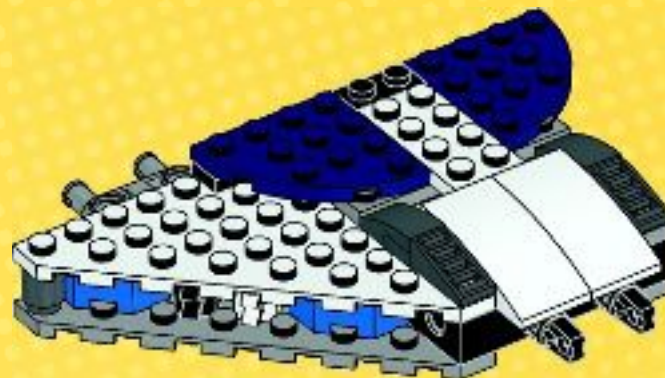



16



17

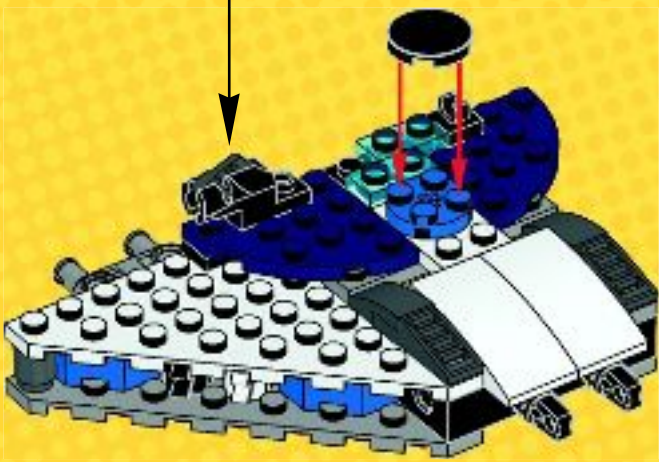

18

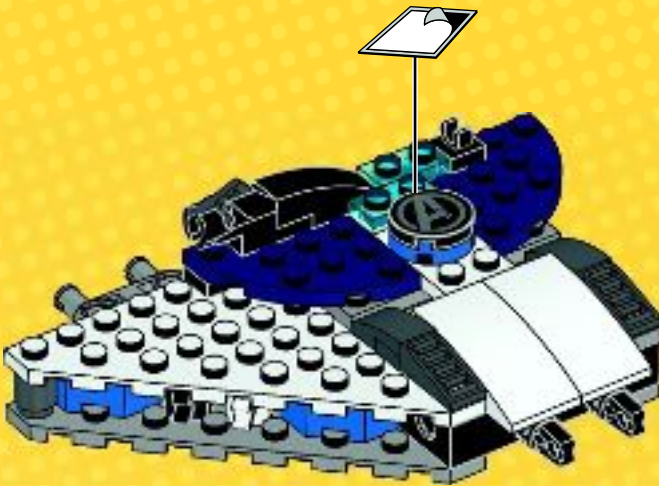



19



20

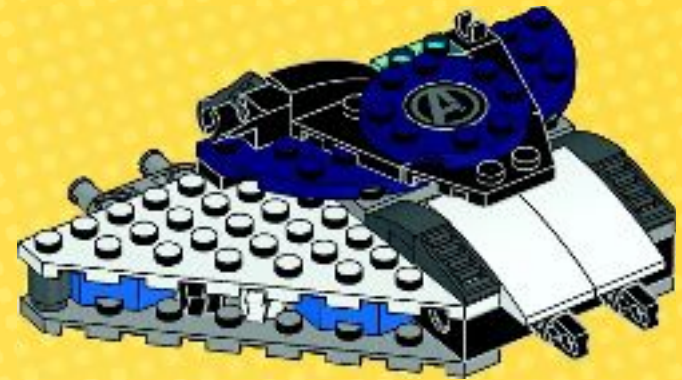



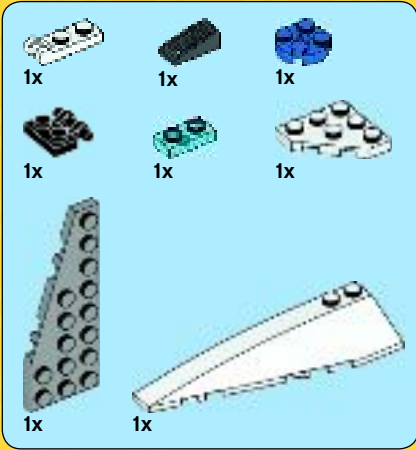

21

1



2



3

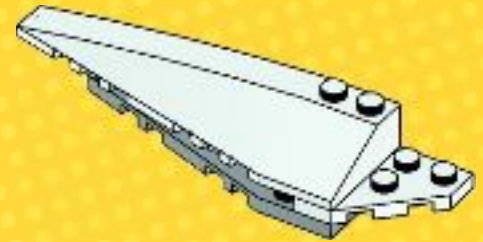

4

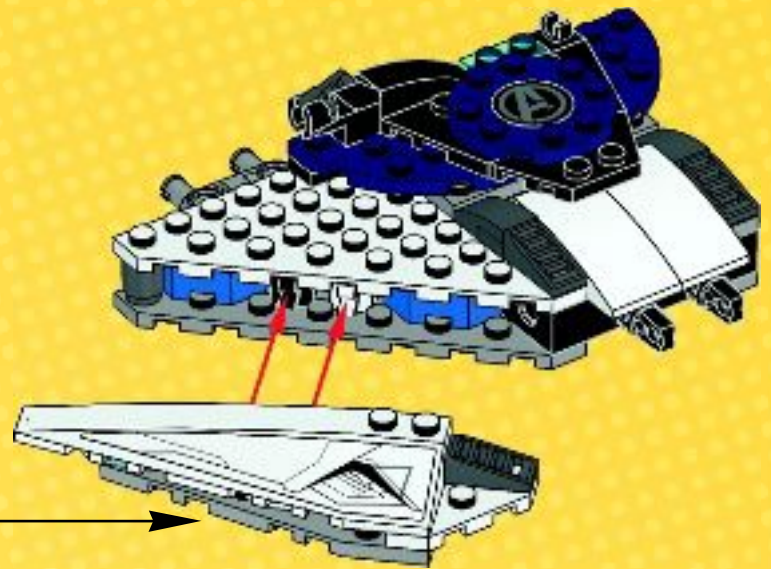
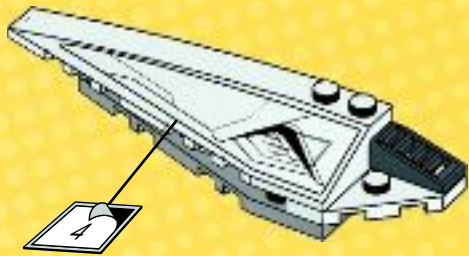

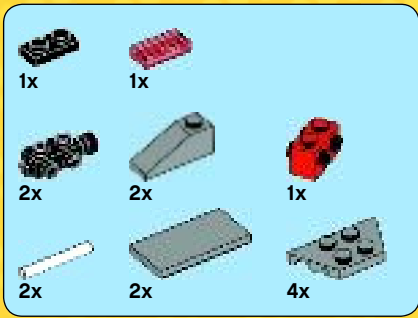

22

1

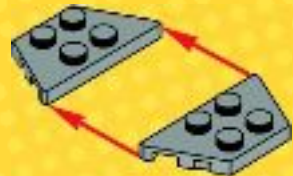

2



3



4

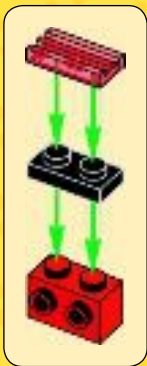

5



6



7



8

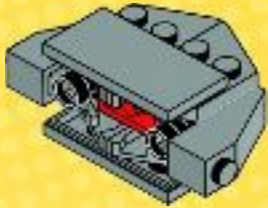

9

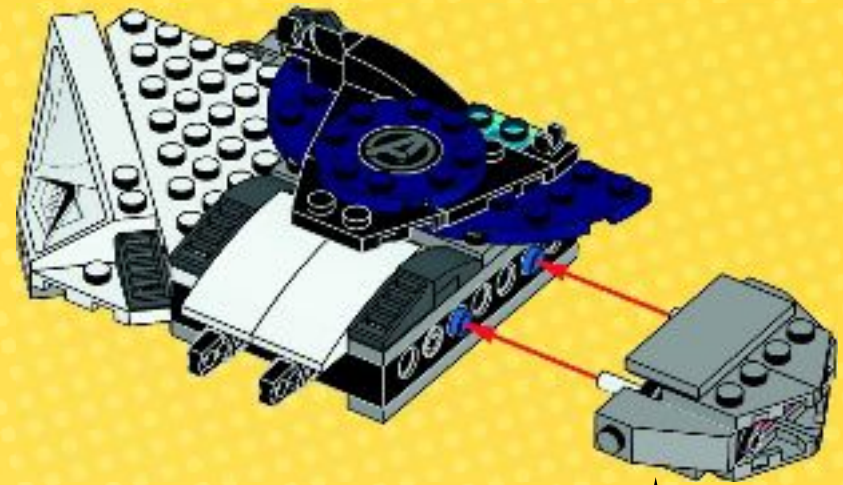
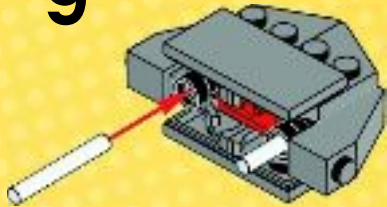

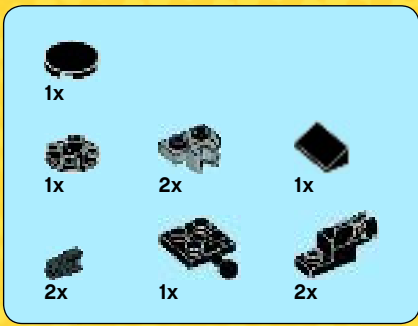

# 23

1



2



3



4

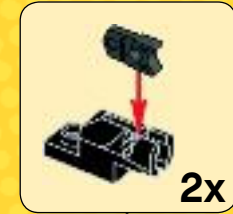

5

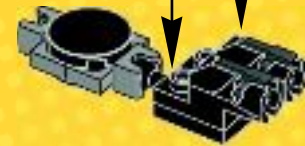

6

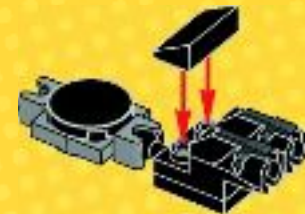

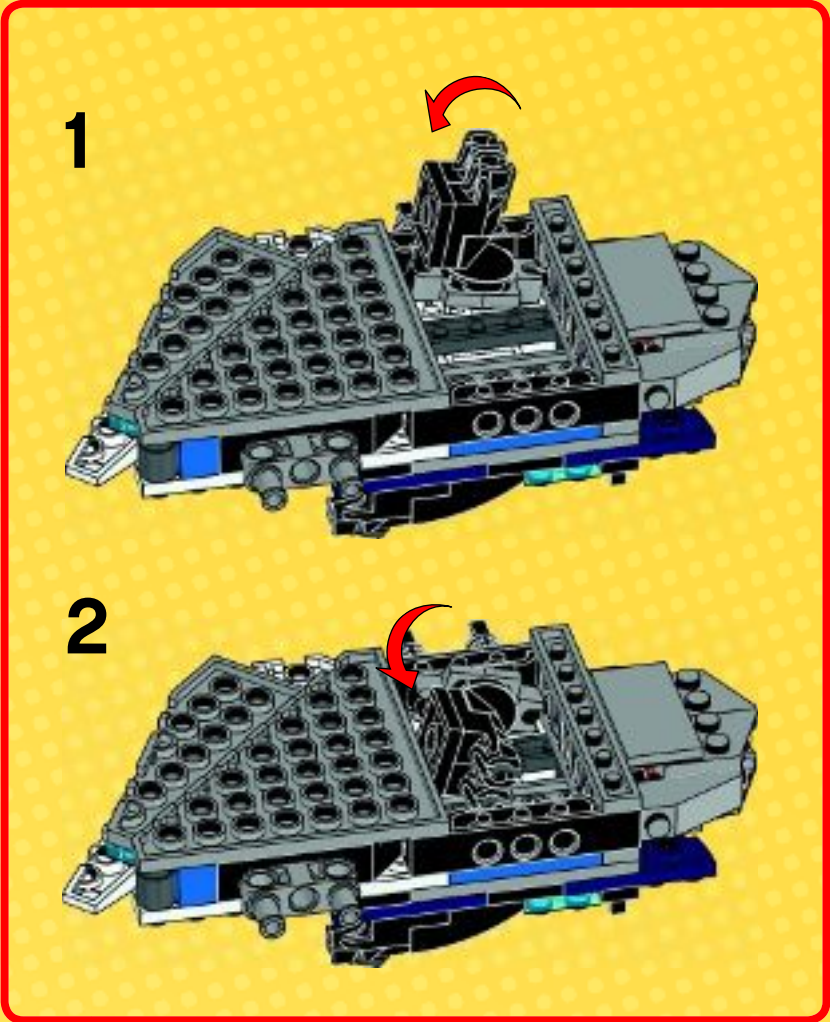
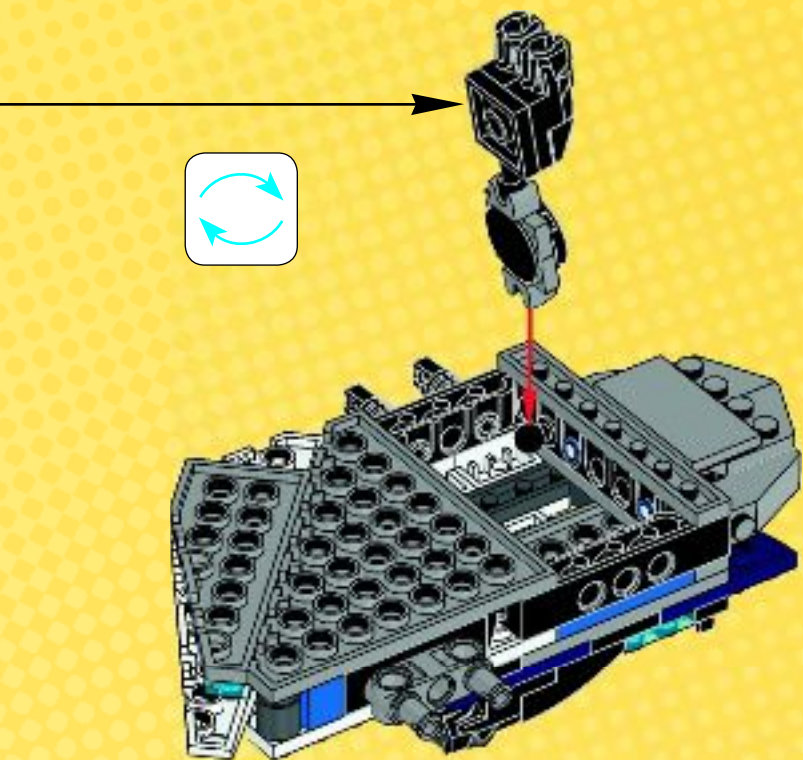



29

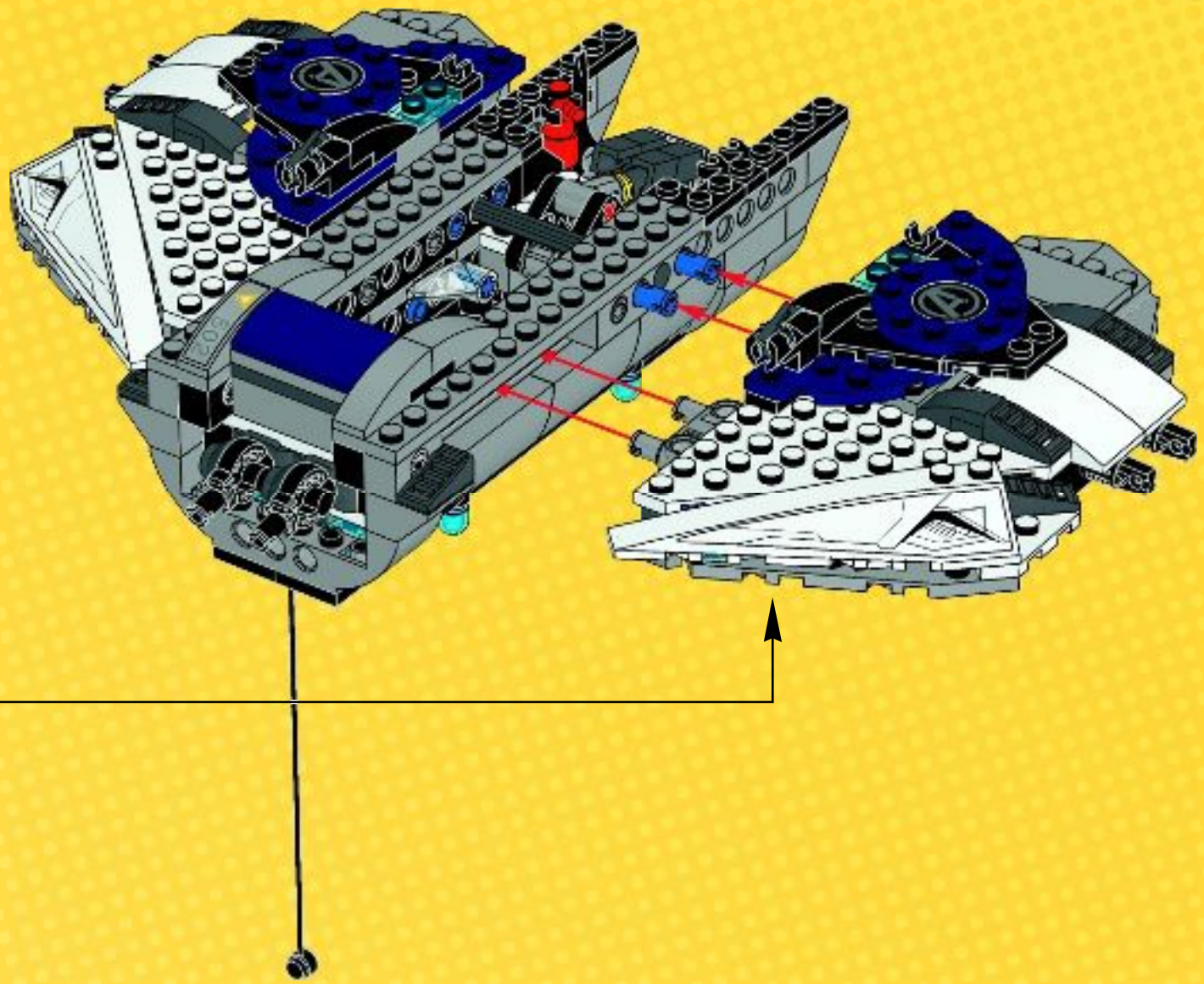

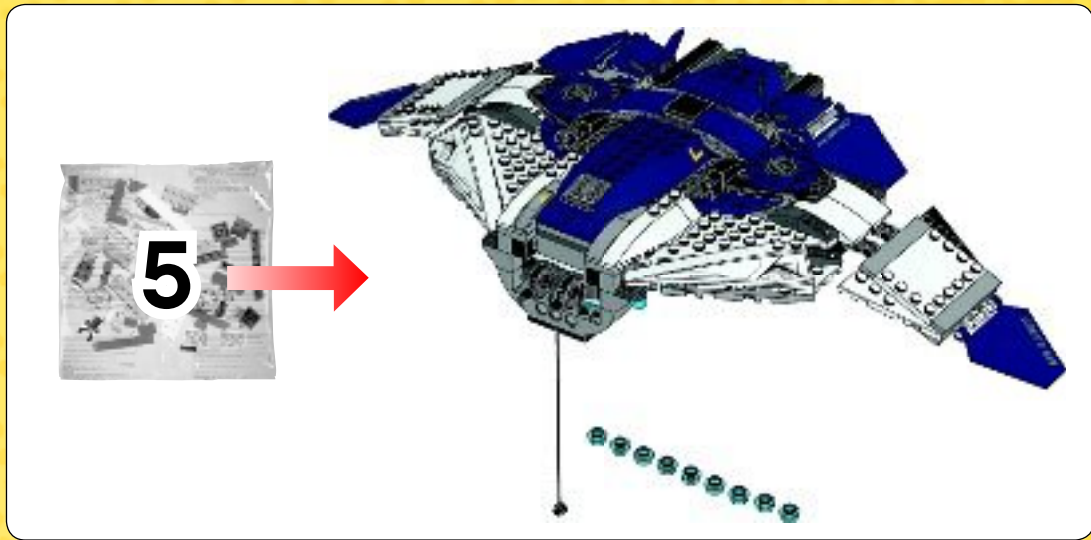

30

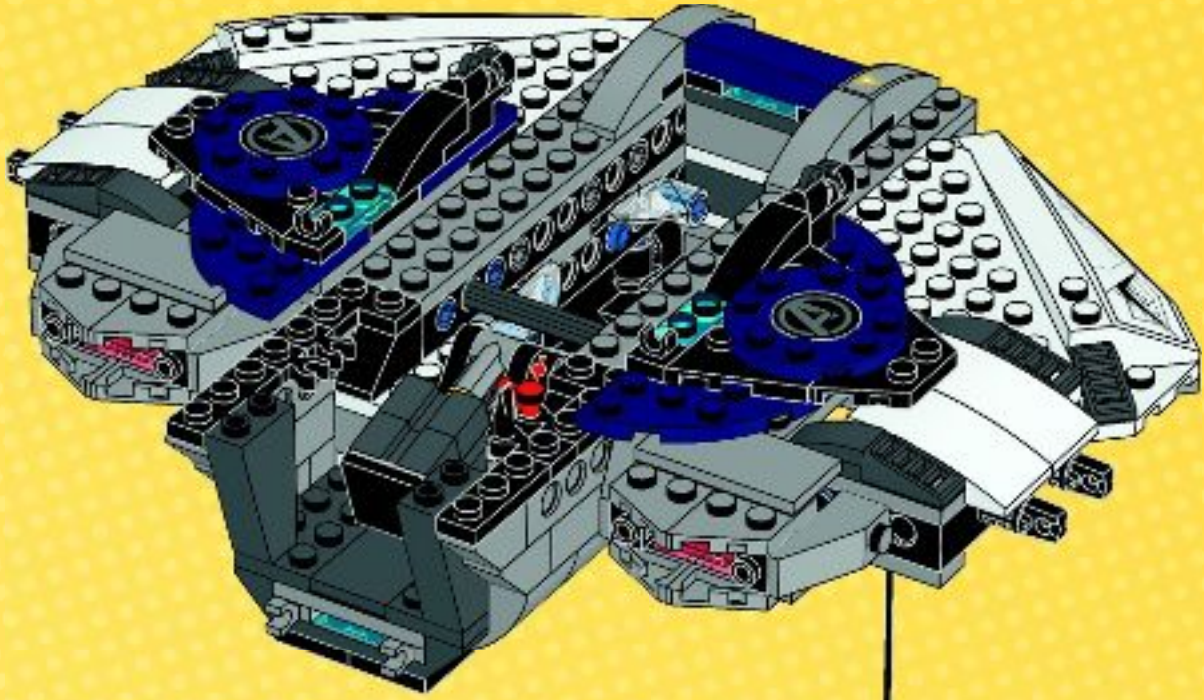





2x

31

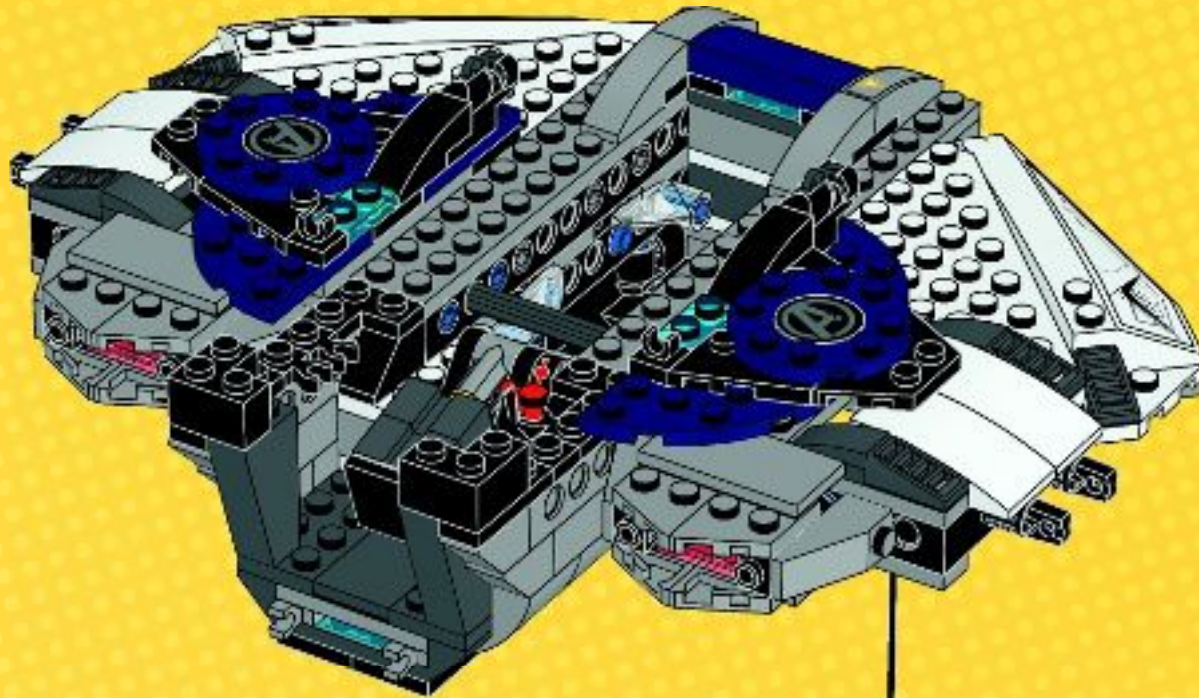

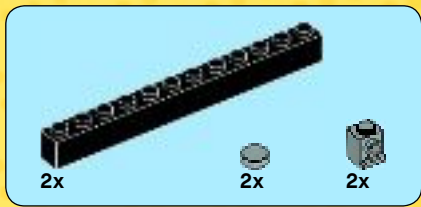

32

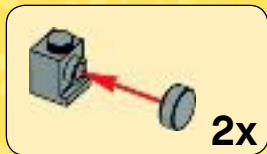
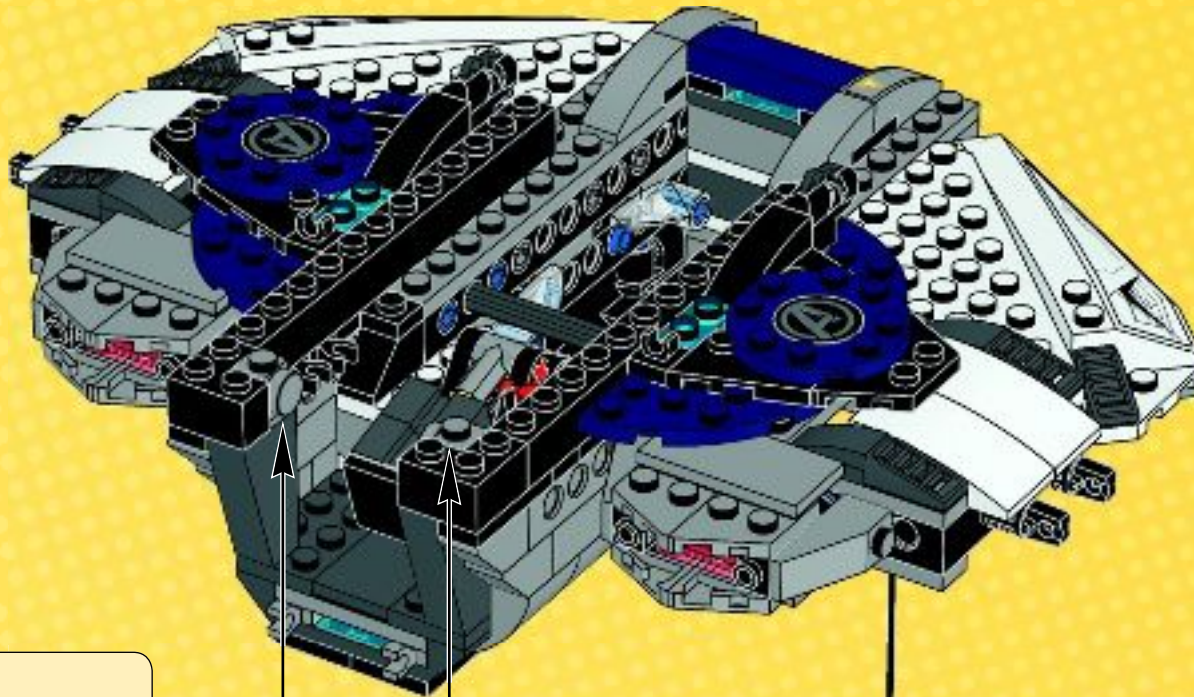



33

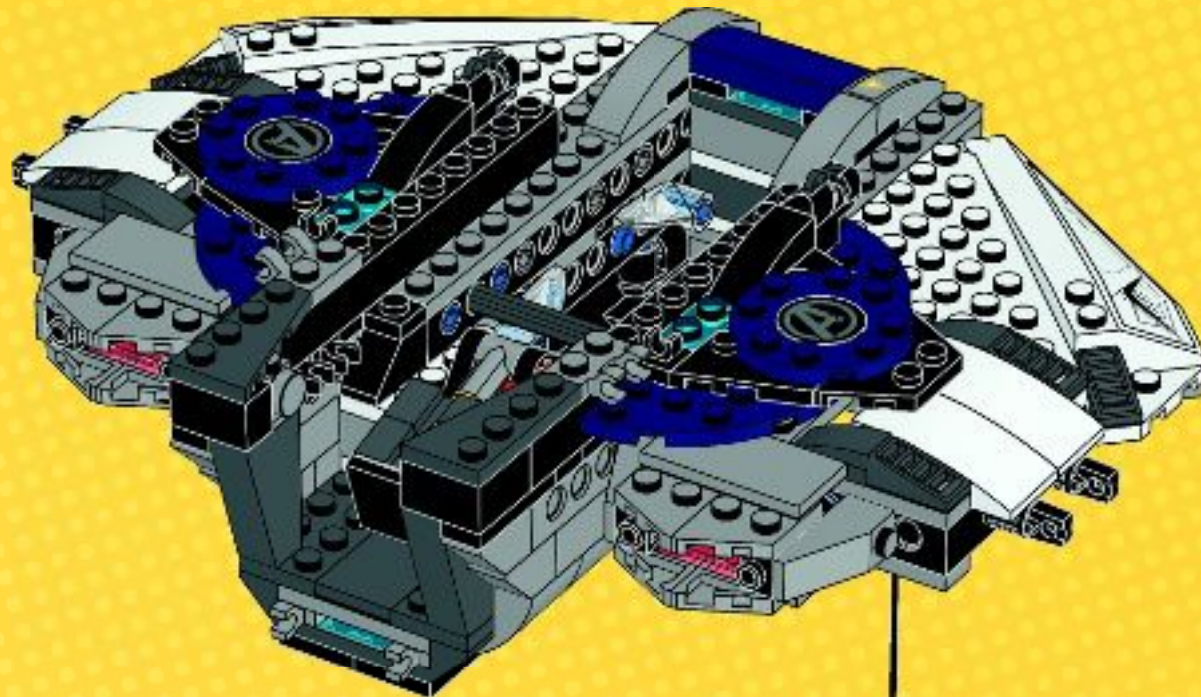

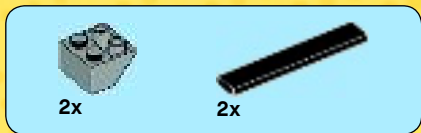

34

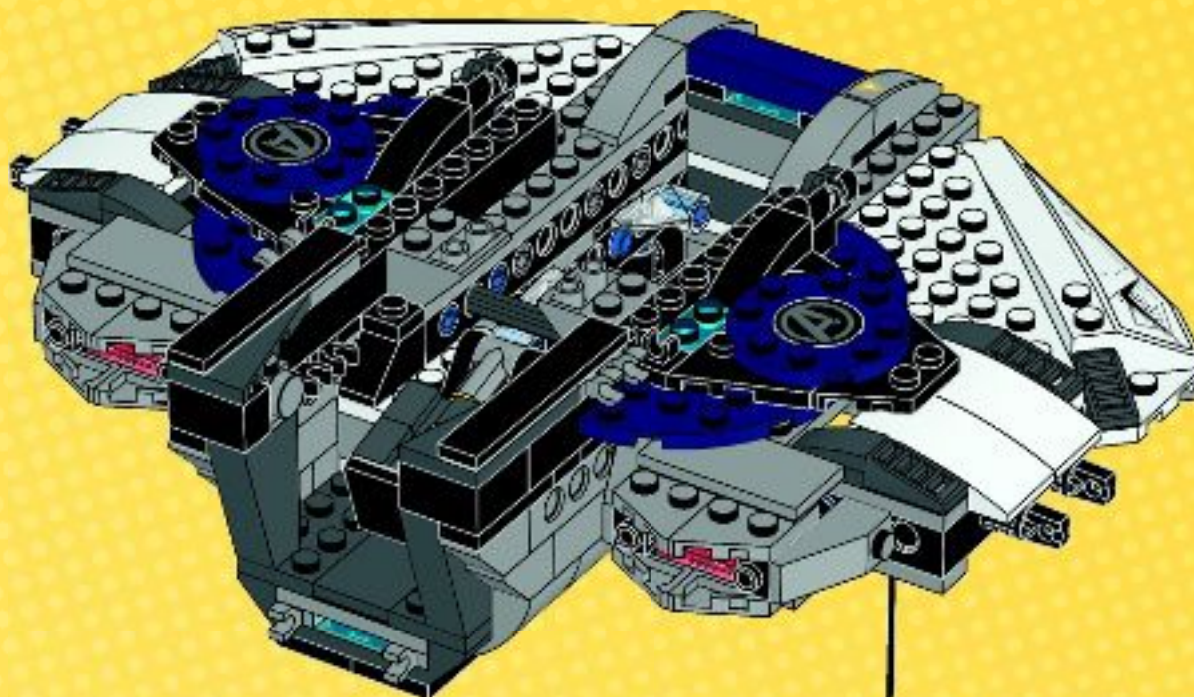

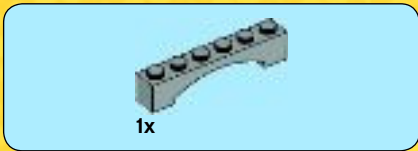

35

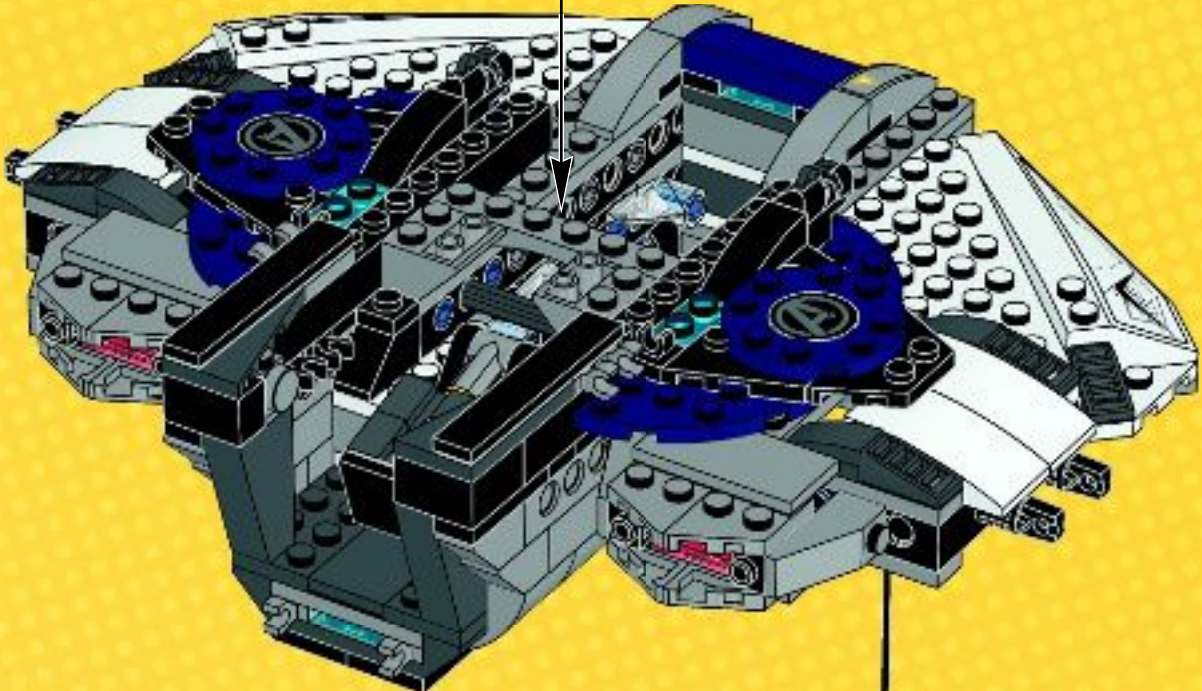
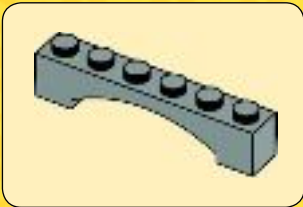

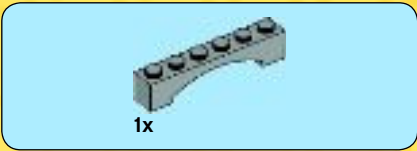

36

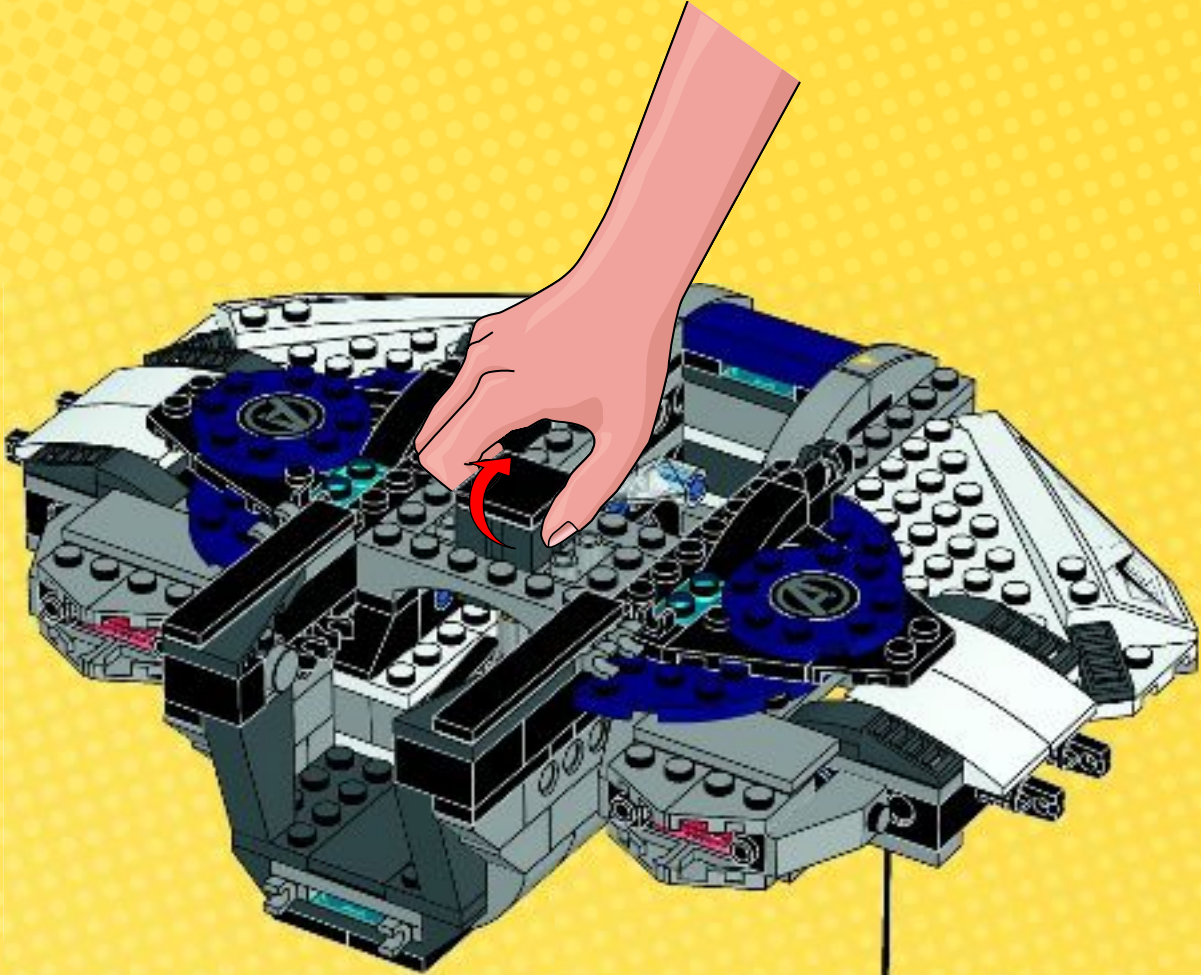



2x



2x

# 37

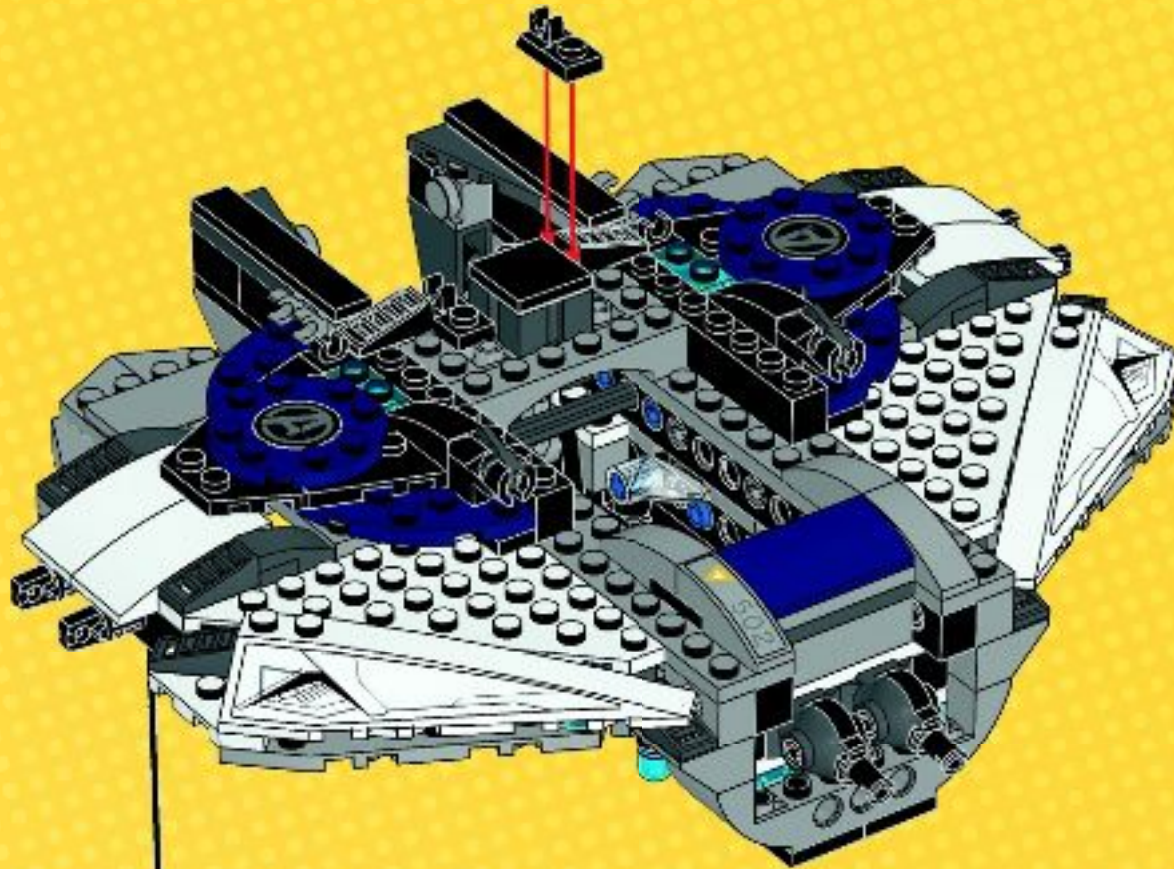
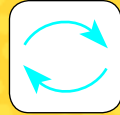



2x



2x

# 38

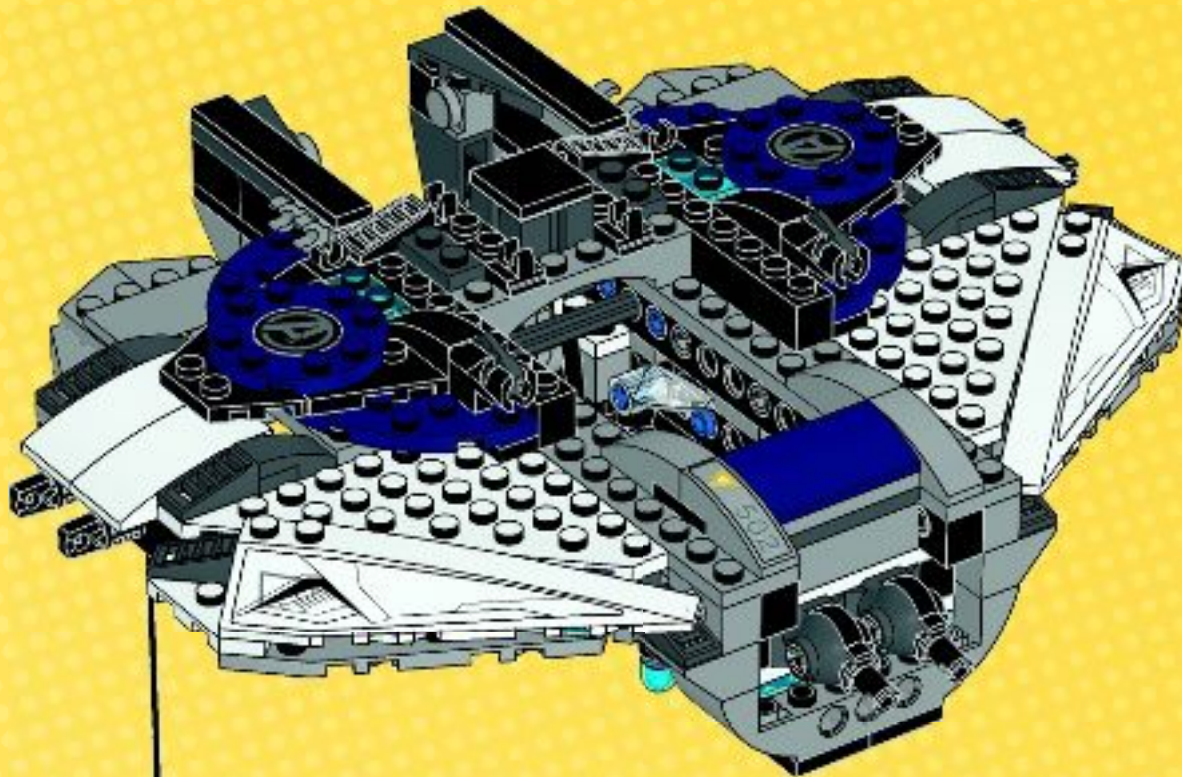





3x

# 39

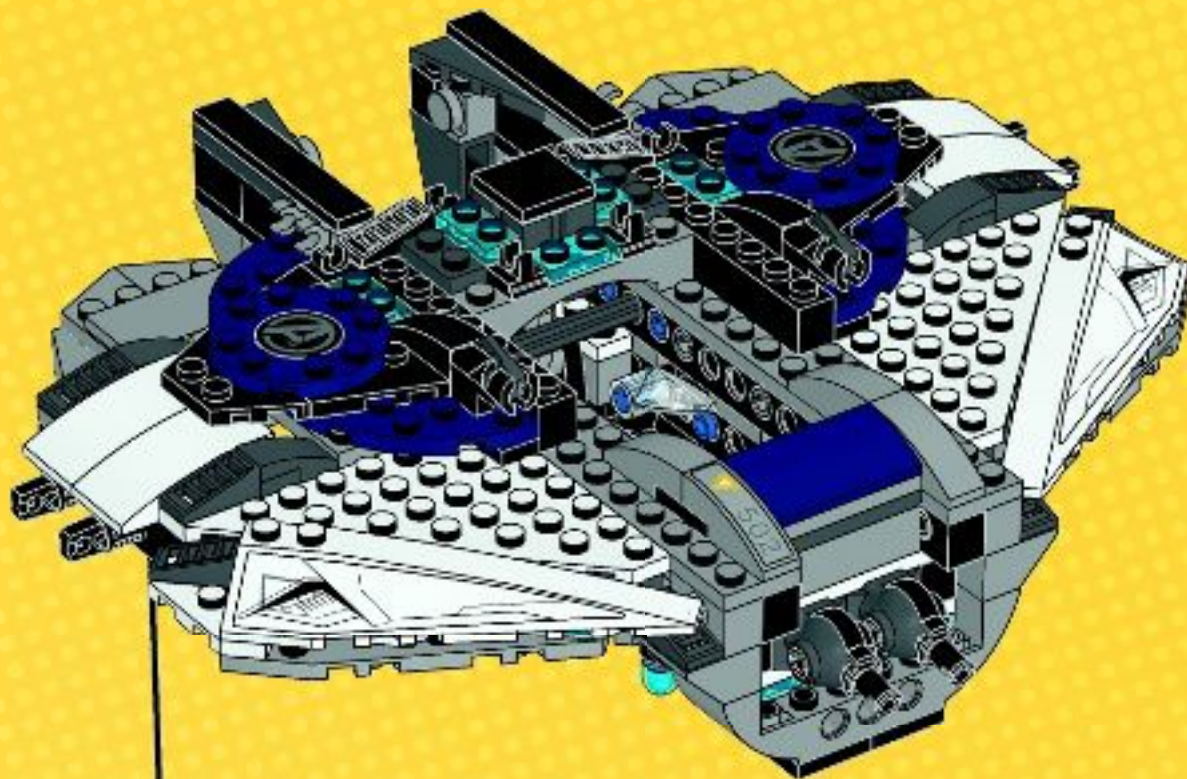



2x

40

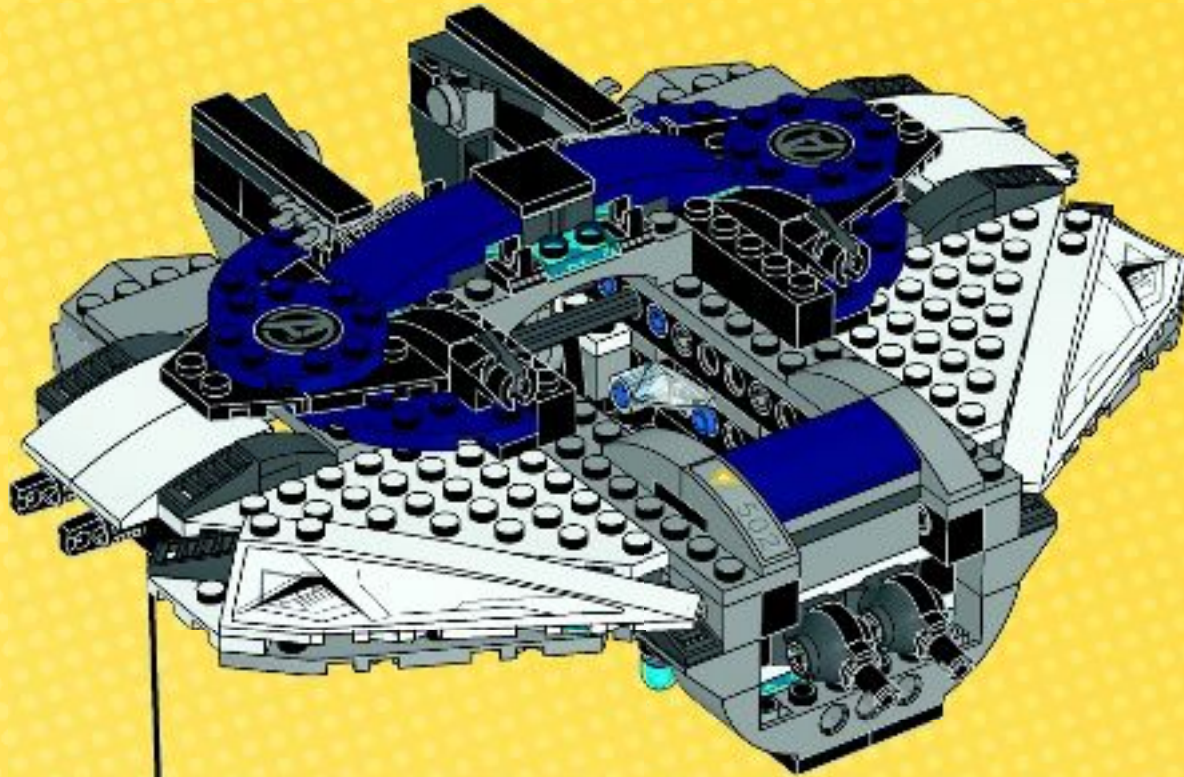

1x

2x

# 41

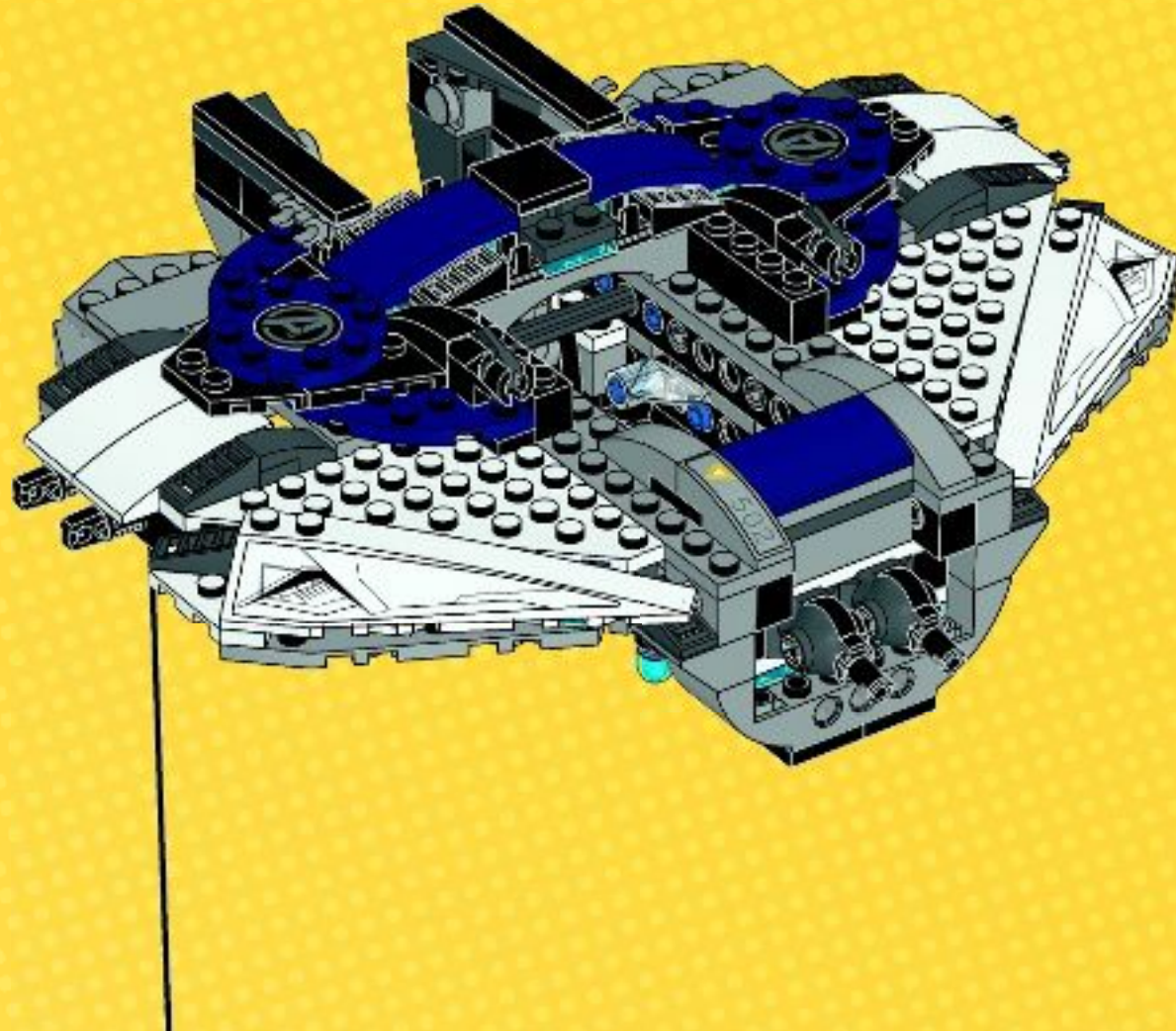

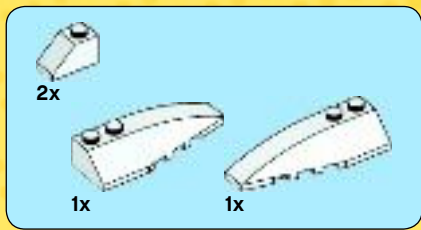

42

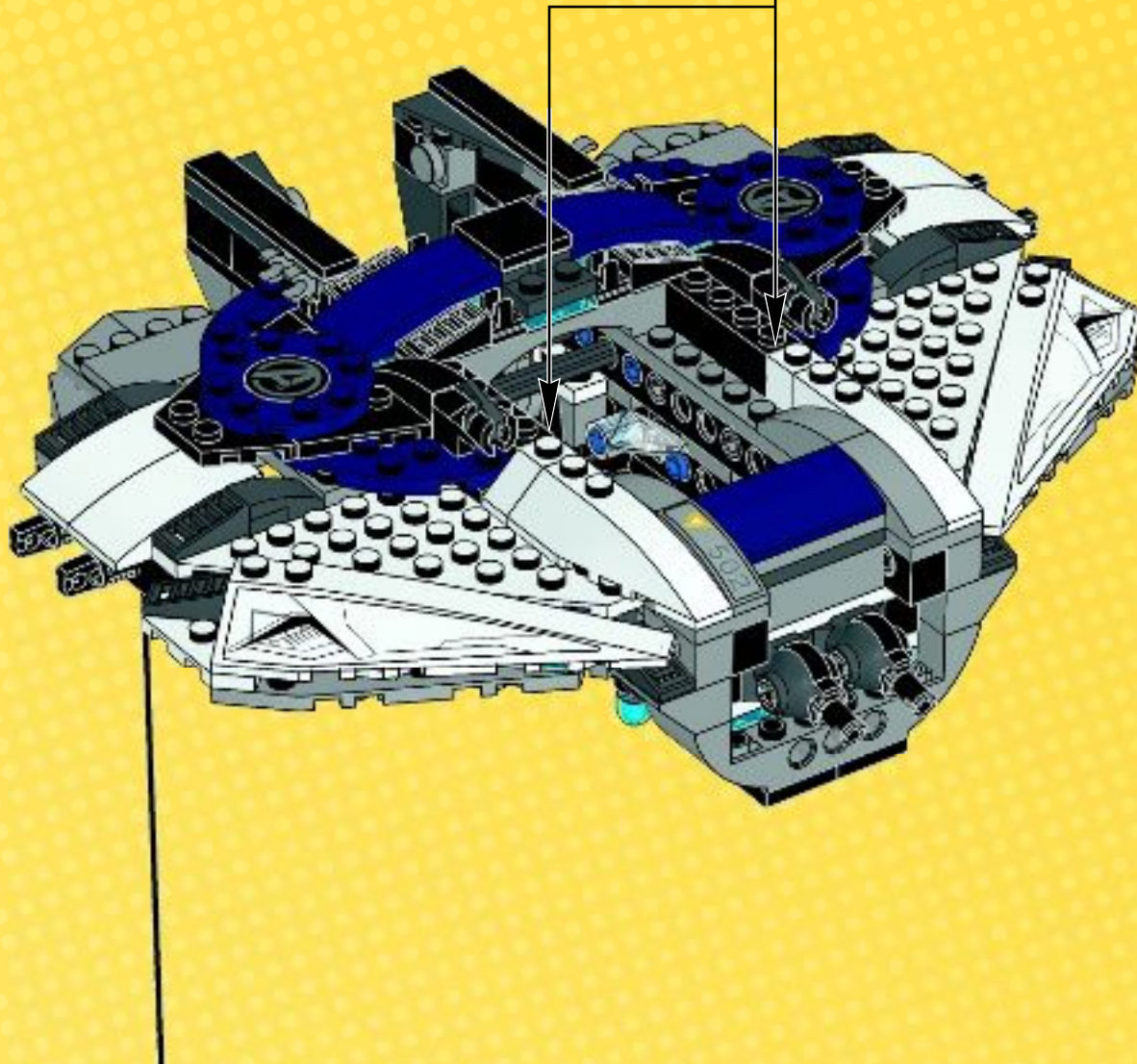
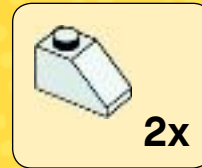

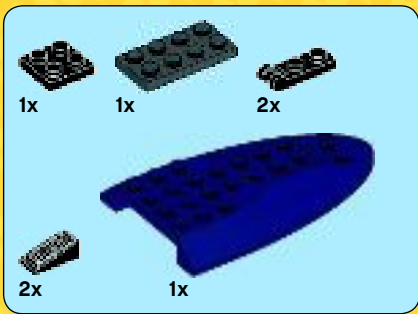

43



2



3



4

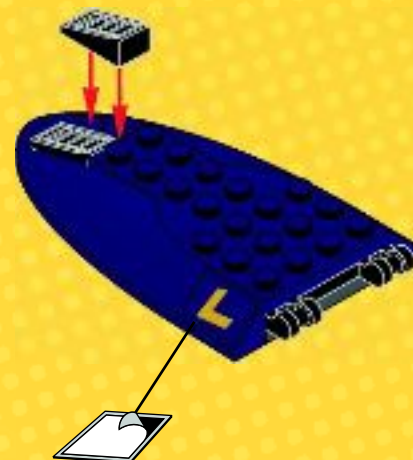

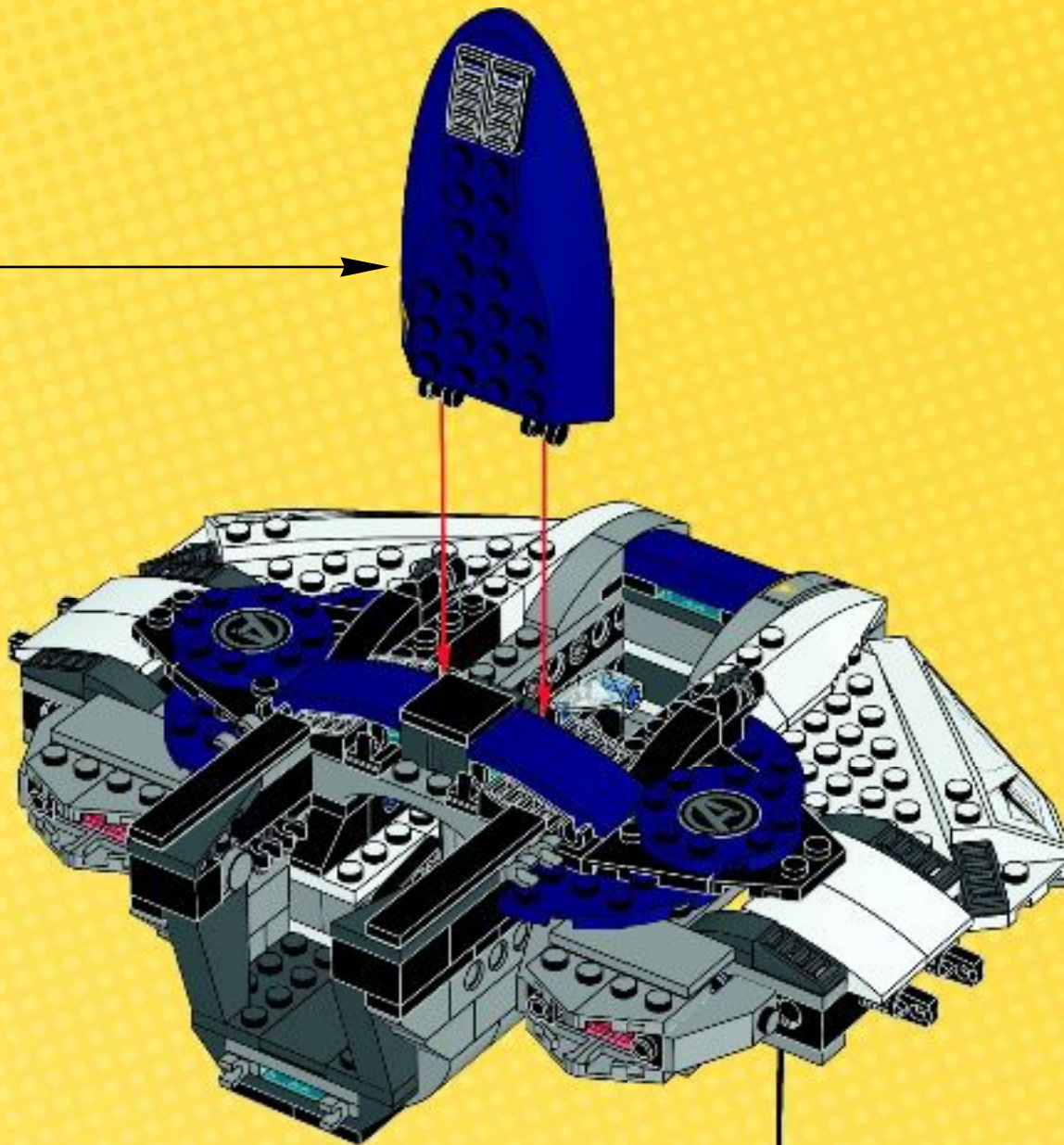

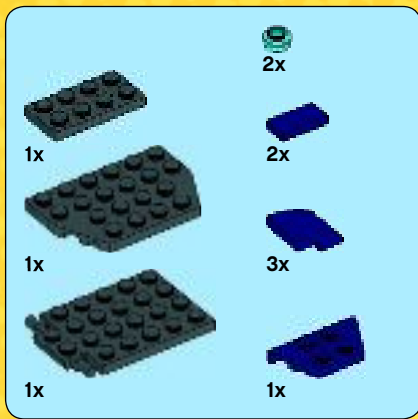

# 44

1



2



3



4



5



6

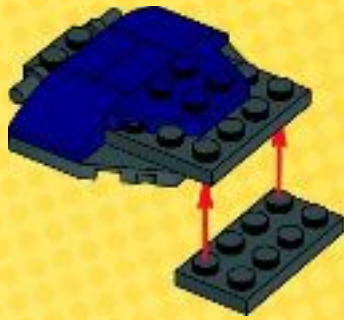

7

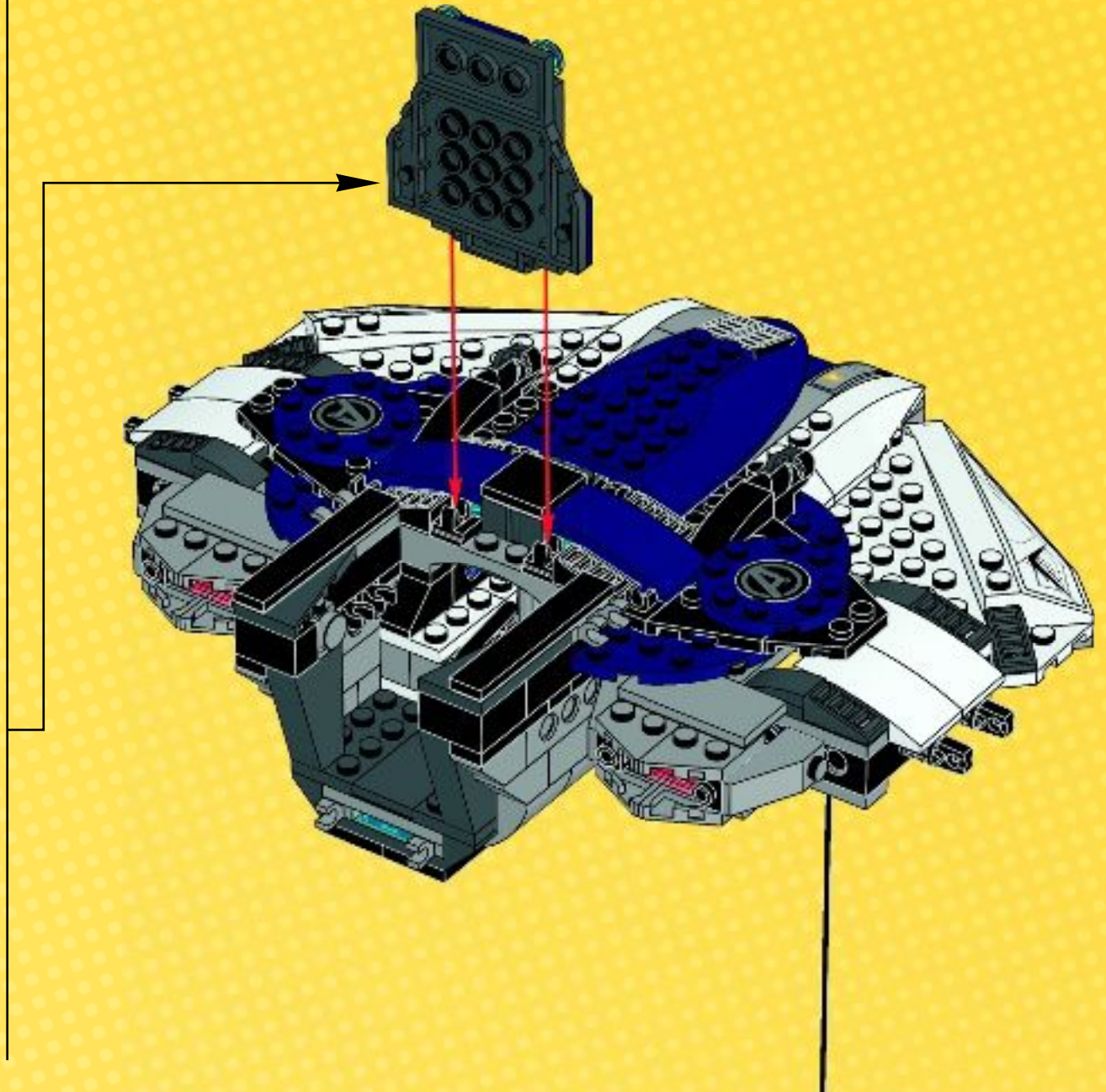



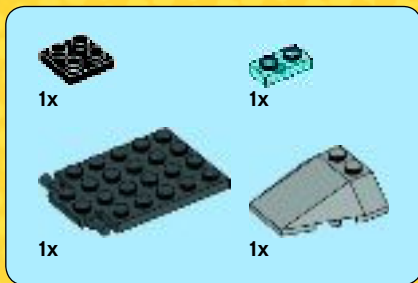

45

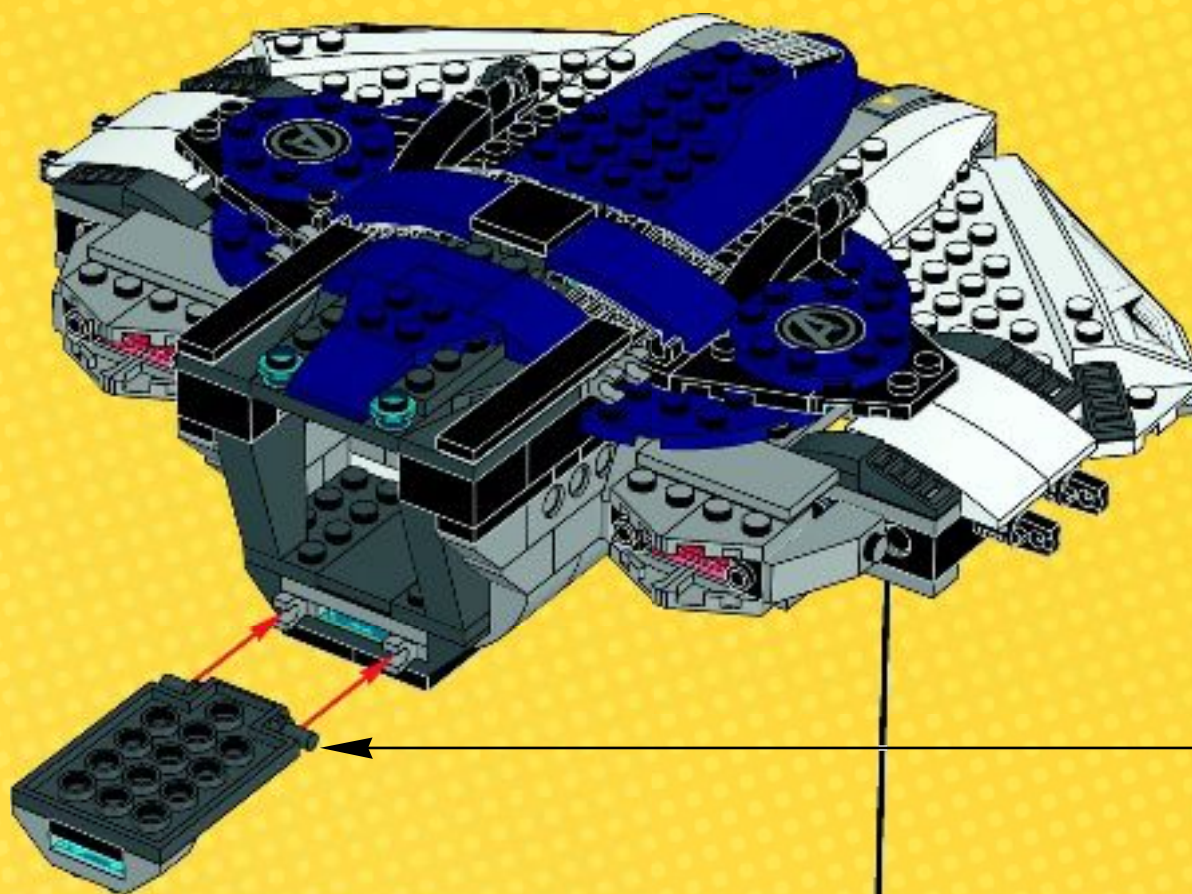



# 46

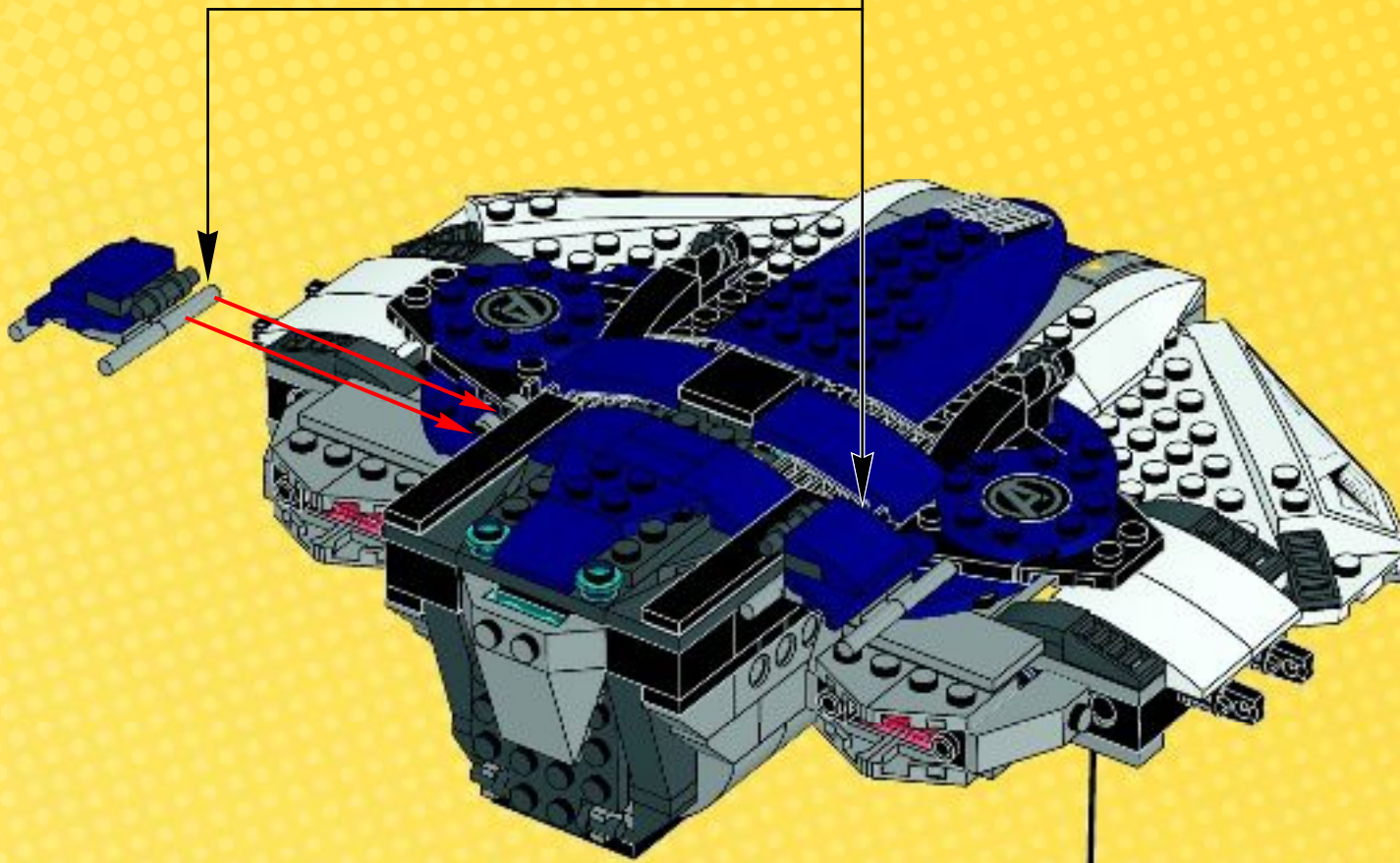
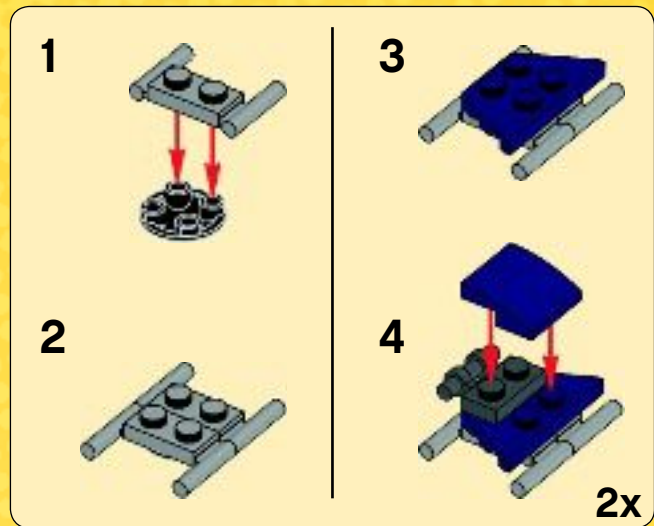

47

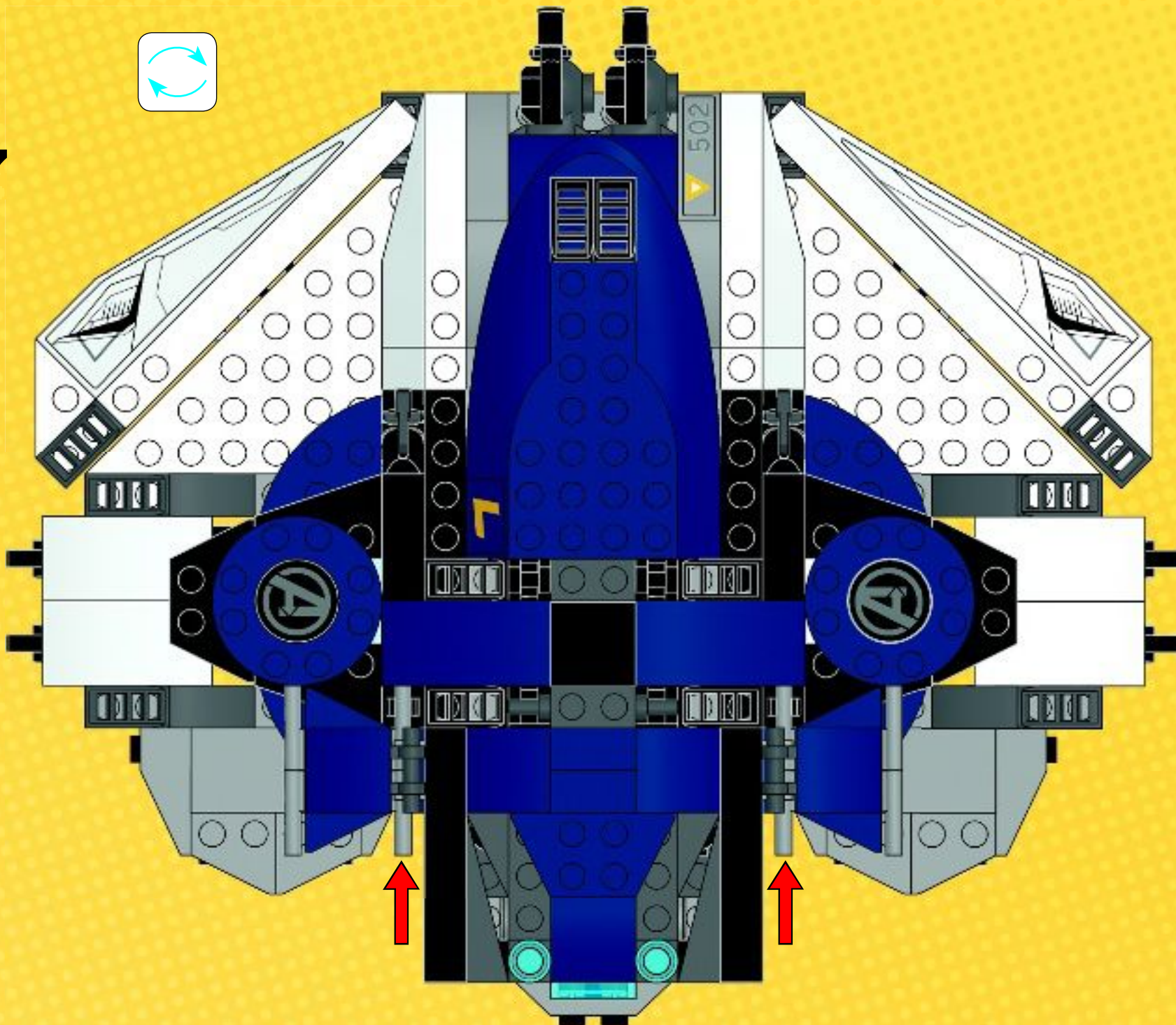

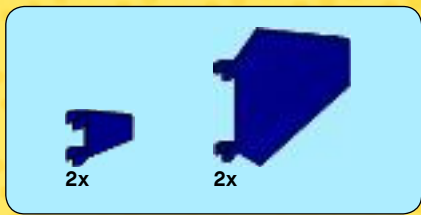

48

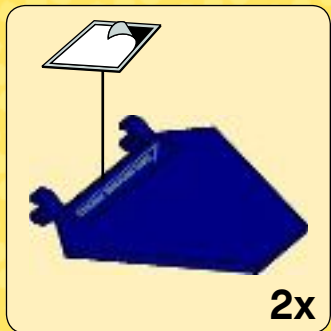
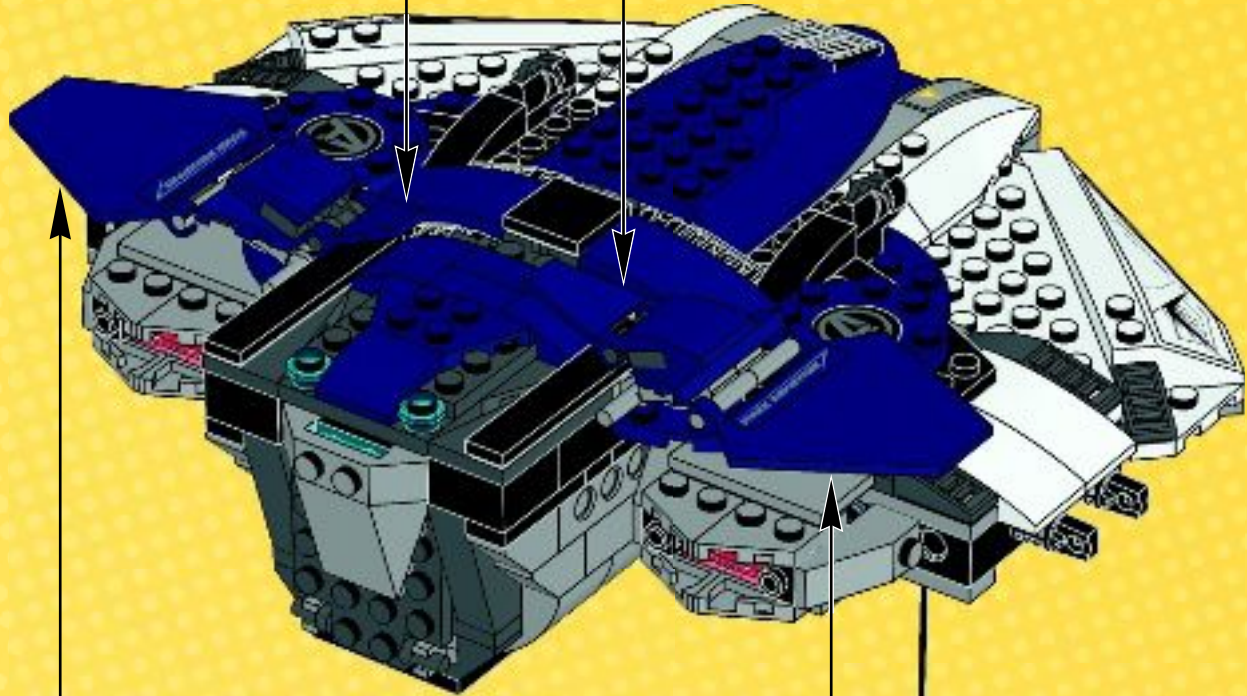



1x

1

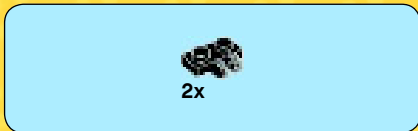

2x

2

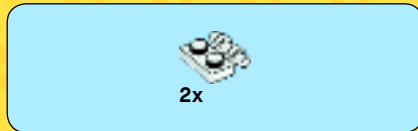

2x

3

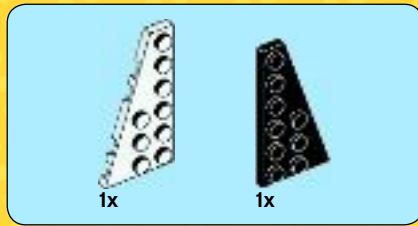

1x

1x

4



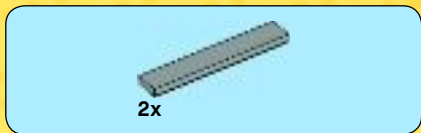

5

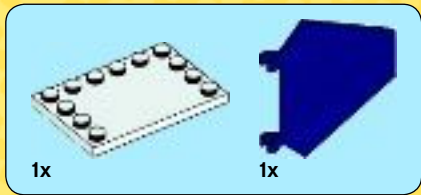

6

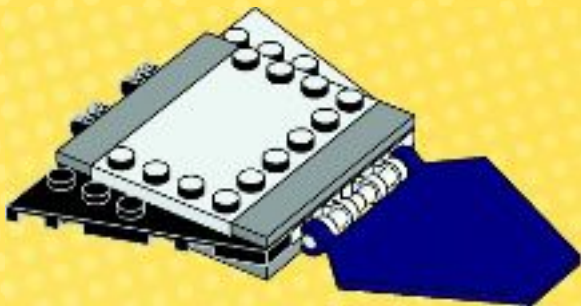

7

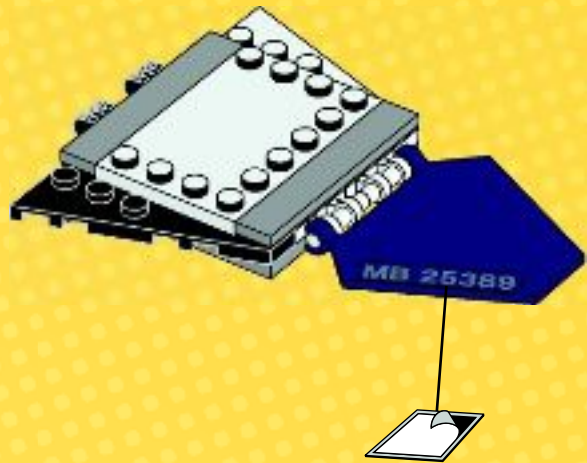



49

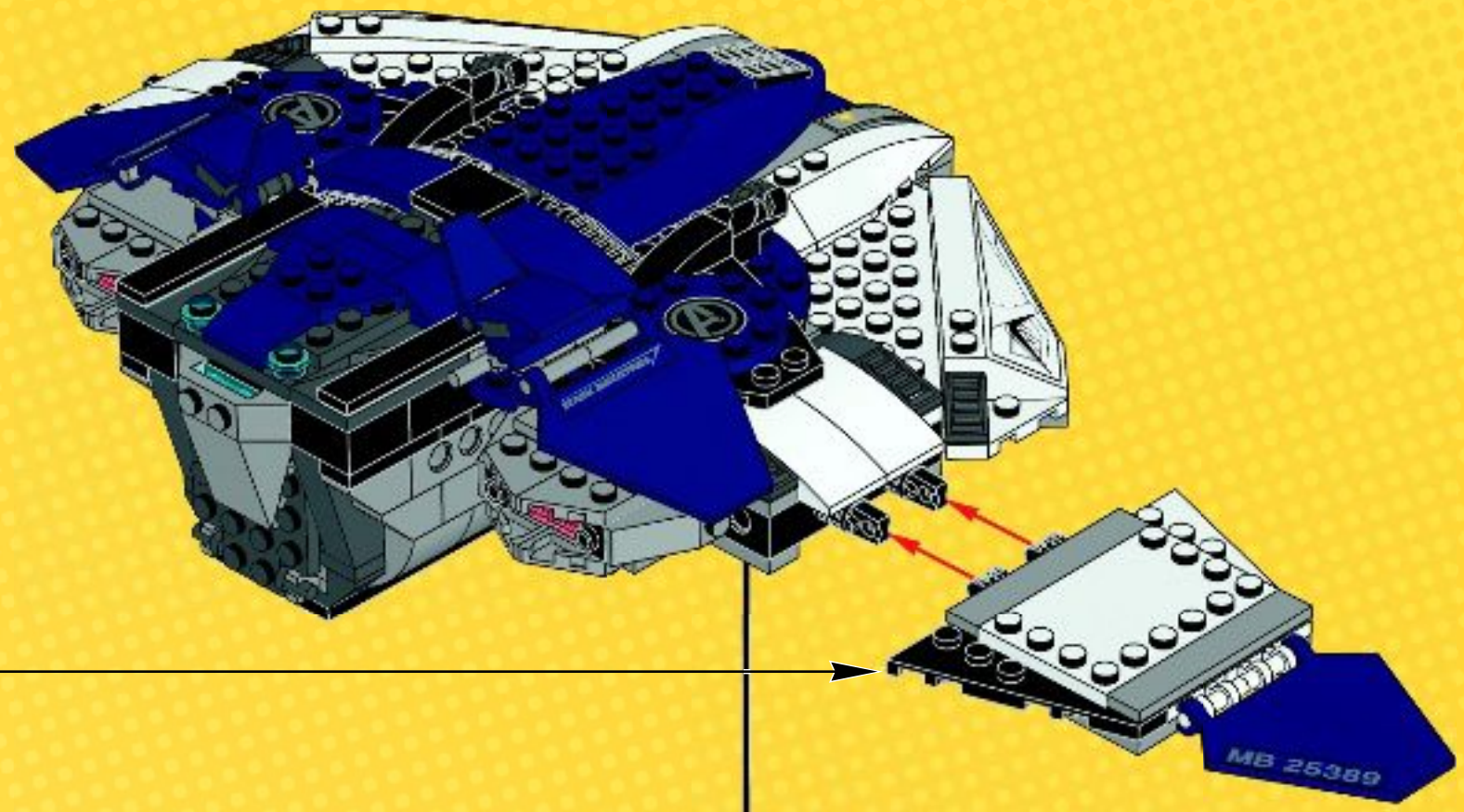



1x

1

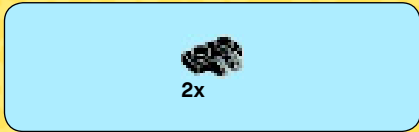

2x

2

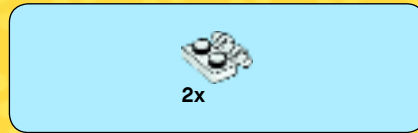

2x

3

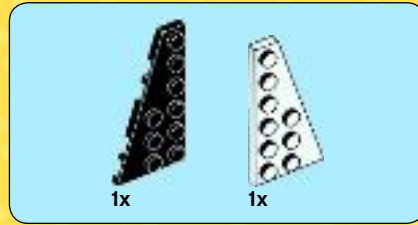

1x

1x

4





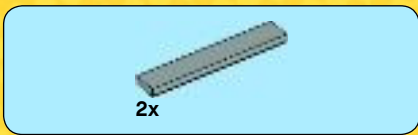

5

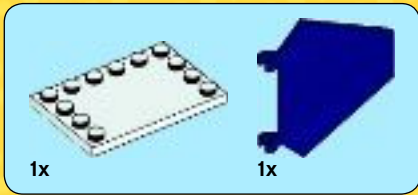
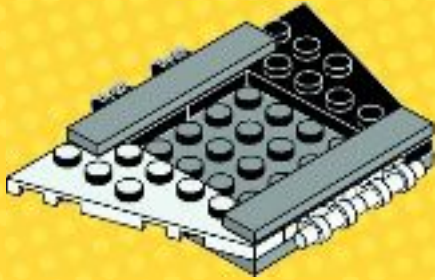

6



7

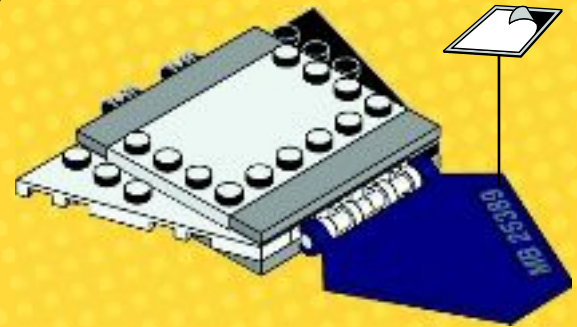

50

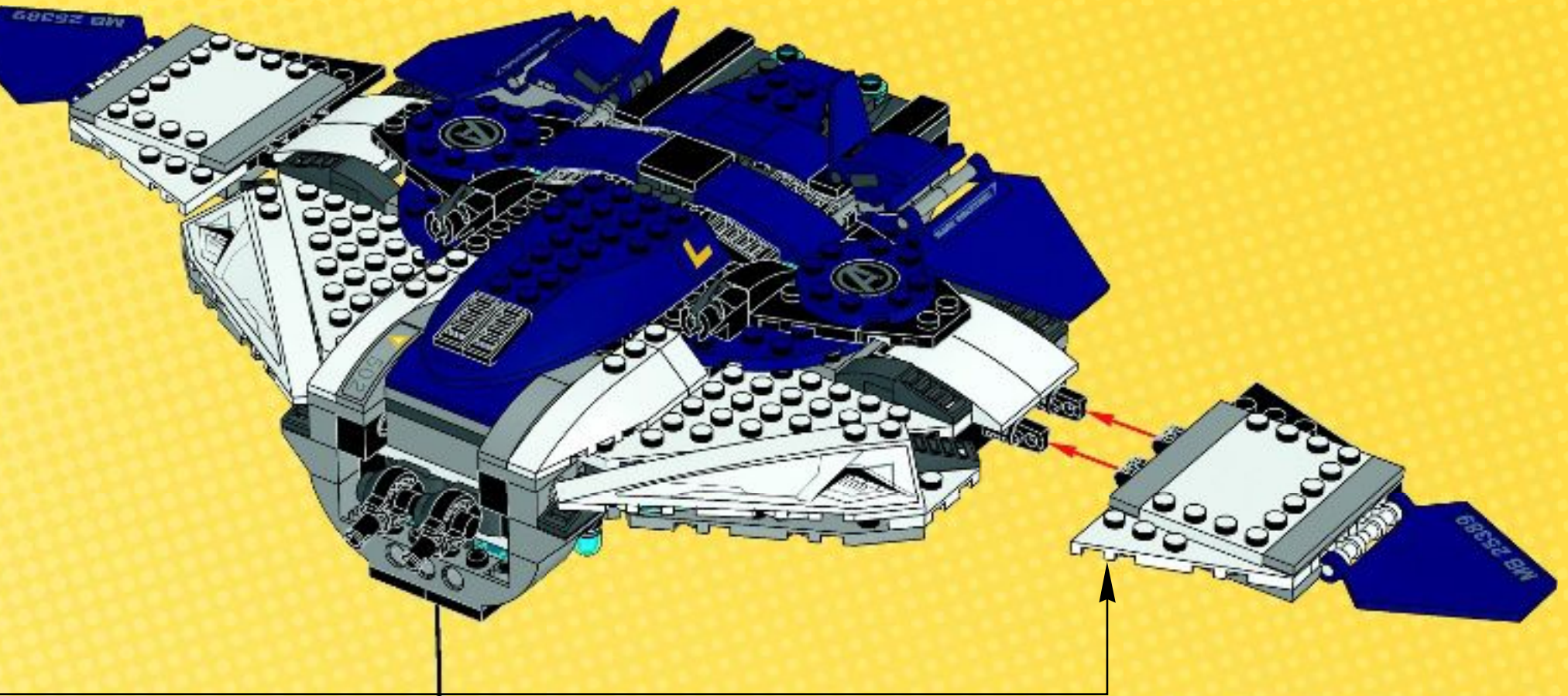

10x

51

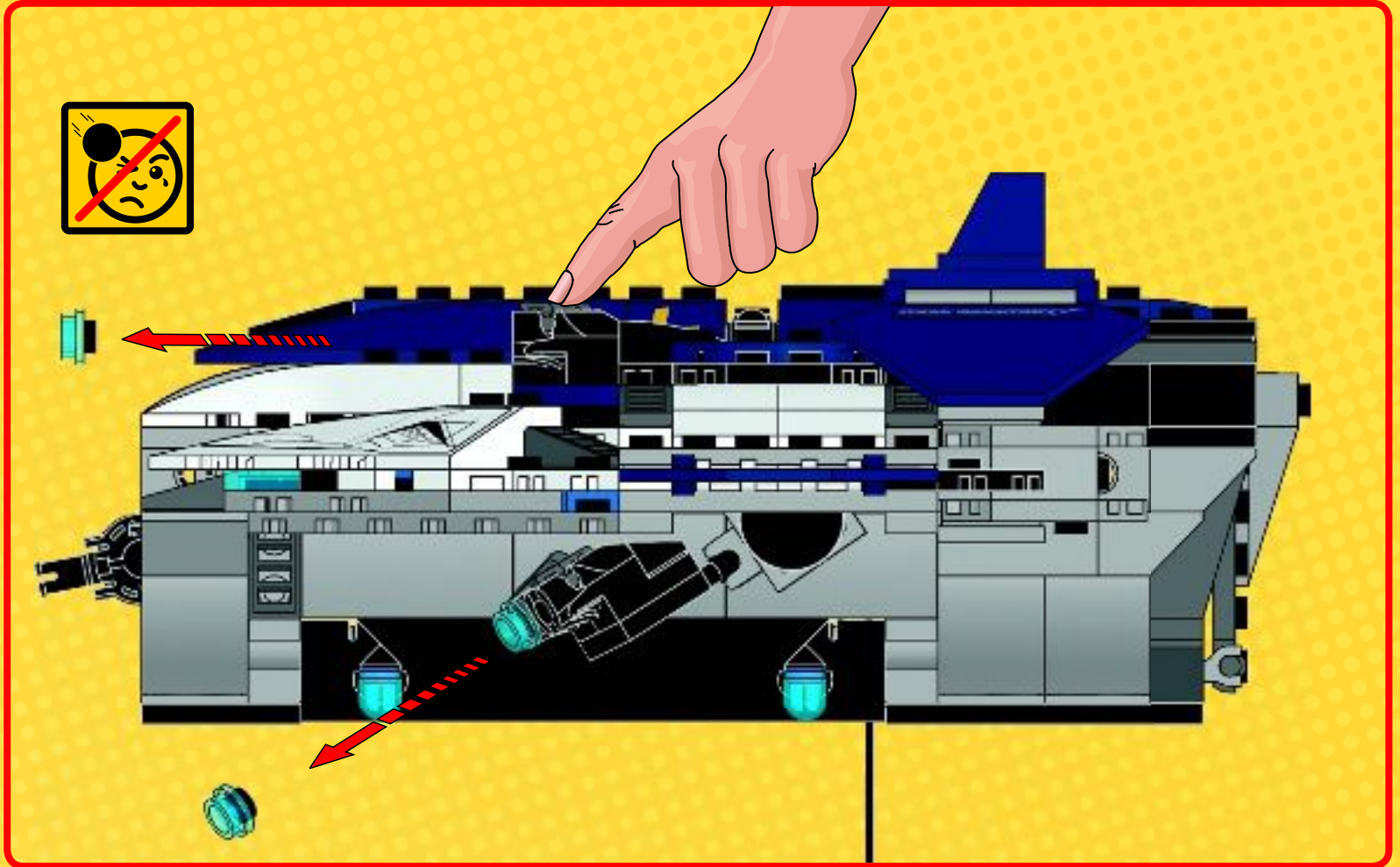

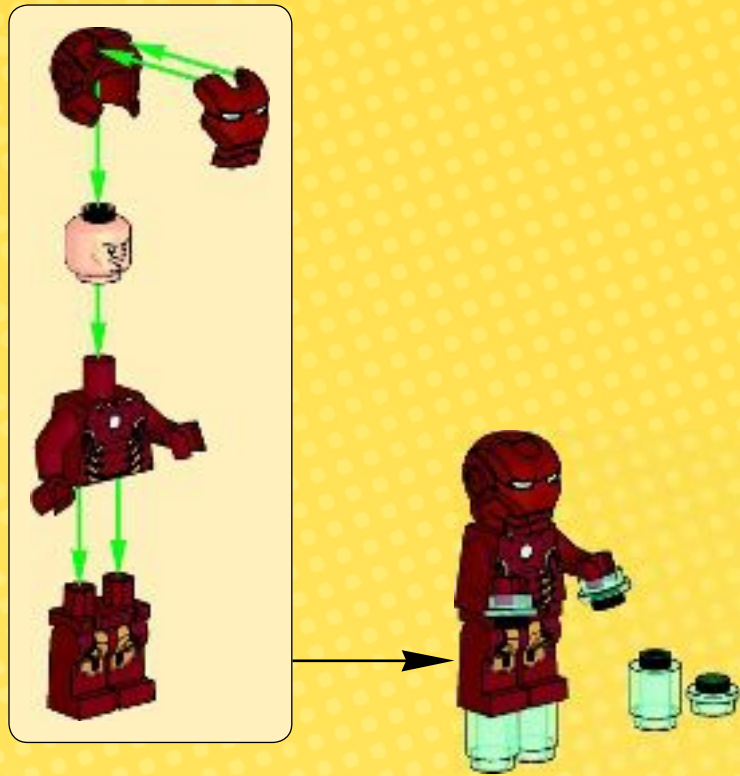
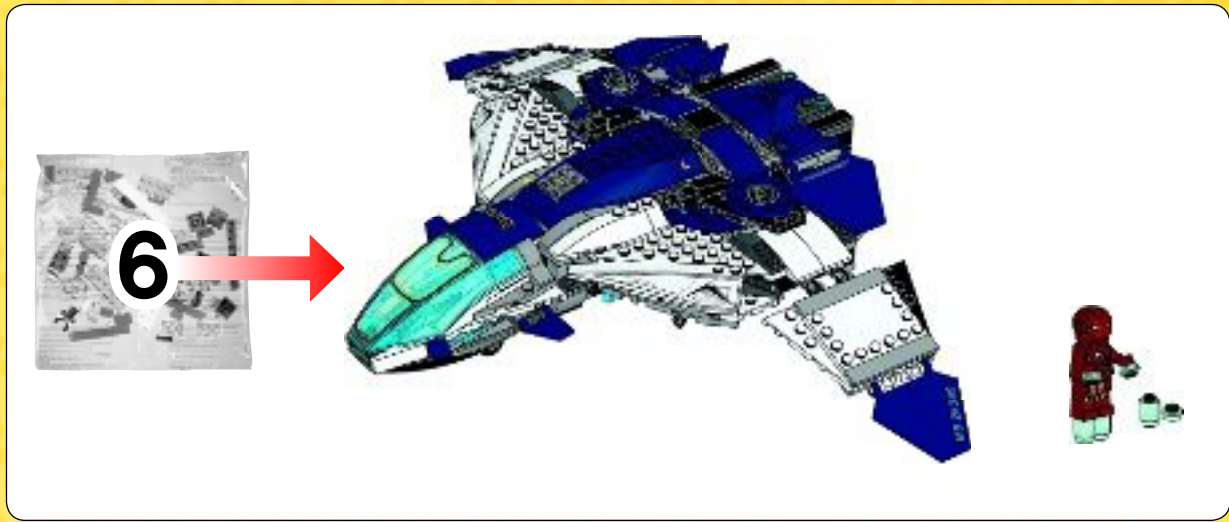

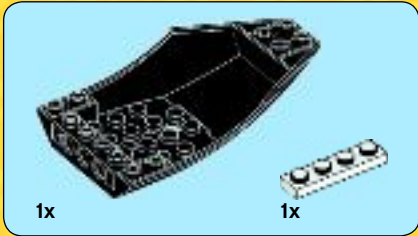

1



2

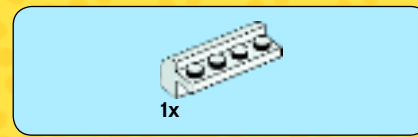

3

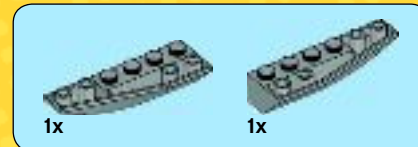

4



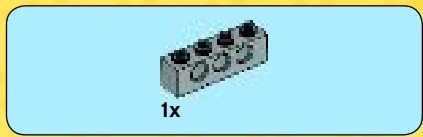

5

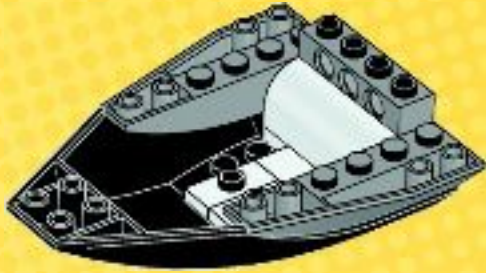

6

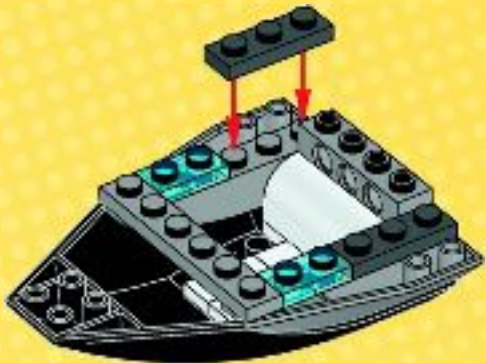

7

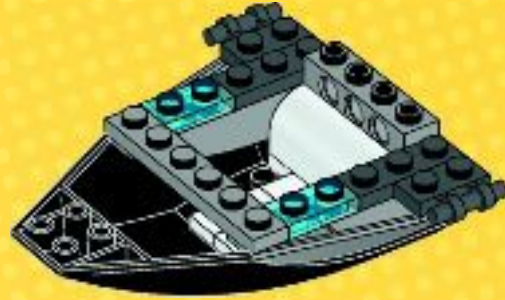

8





1x

# 9

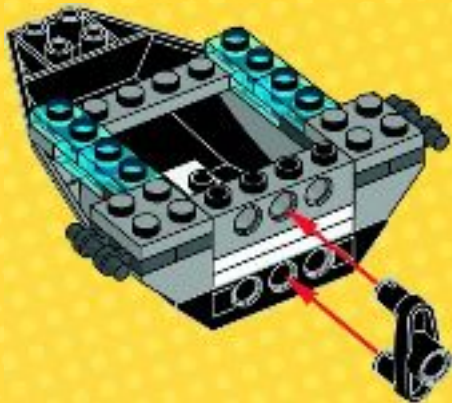

2x



2x

# 10

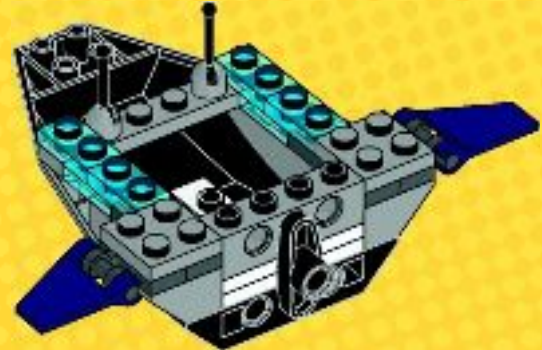

4x



1x



1x

# 11



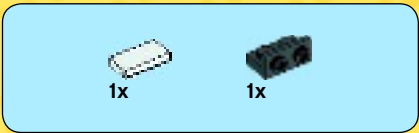

12

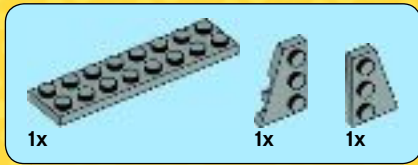
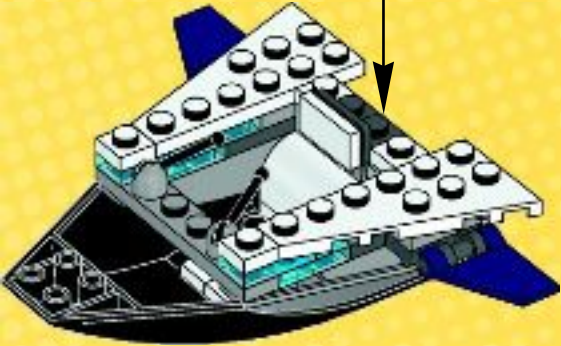
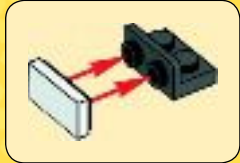

13

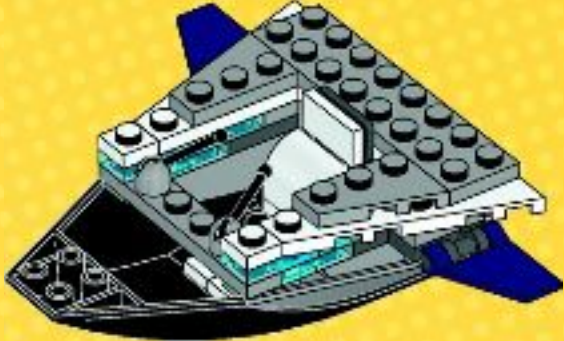

14

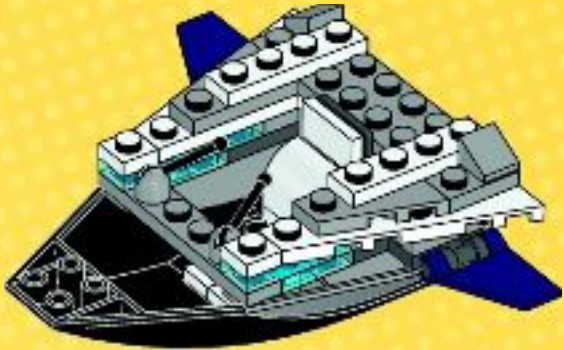



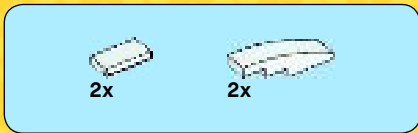

15

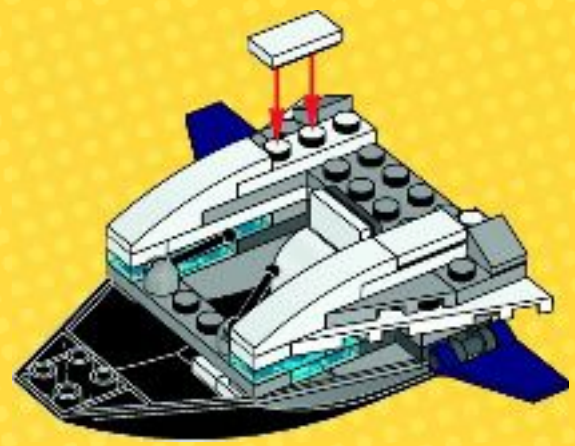

16



17

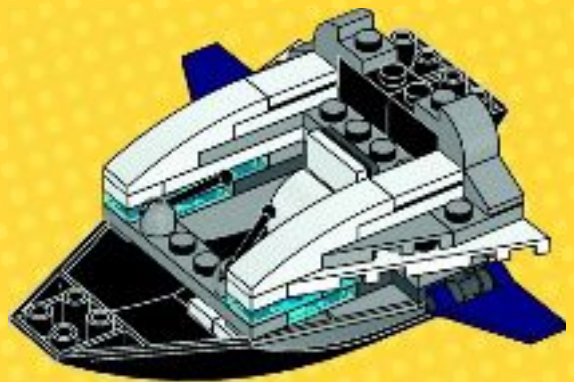



2x



1x

# 18

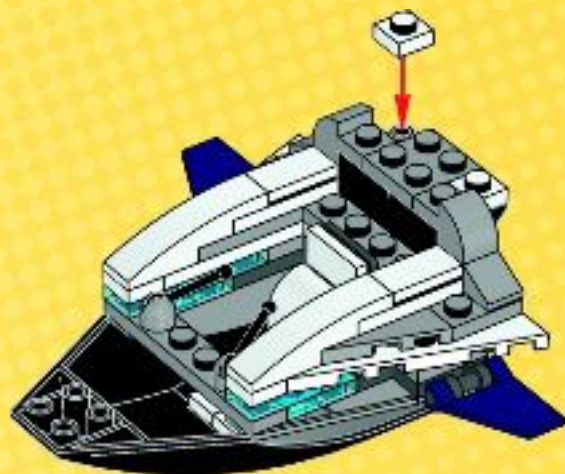

2x

# 19



2x



1x

# 20

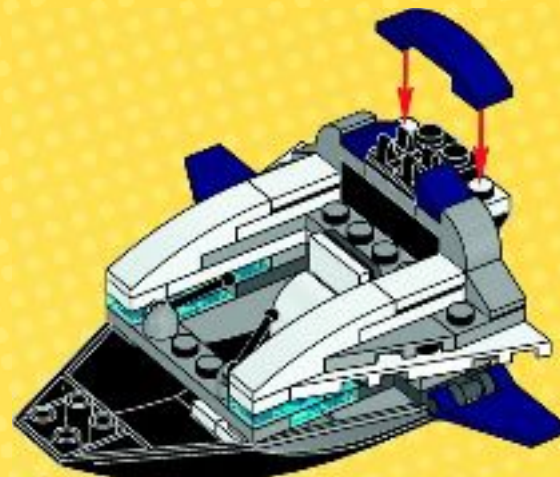

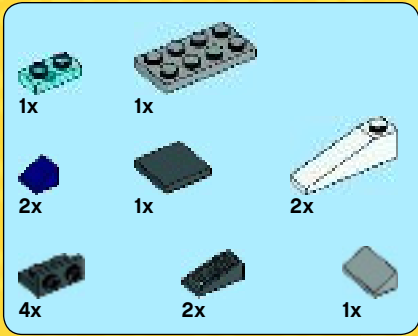

21

1



2



3



4

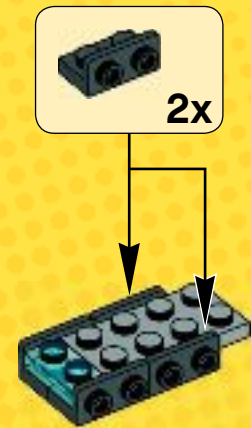

5



6



7



8



9



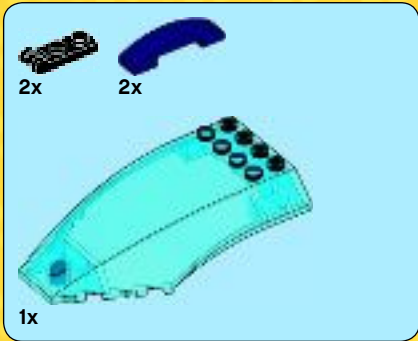

22

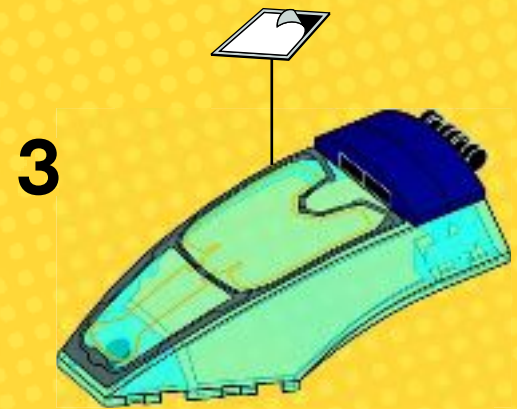
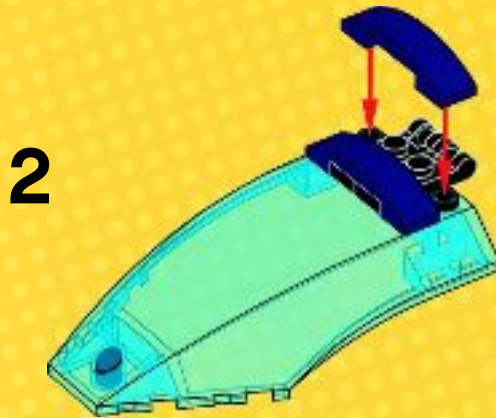
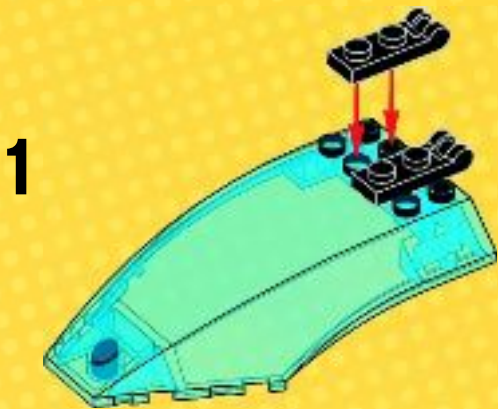

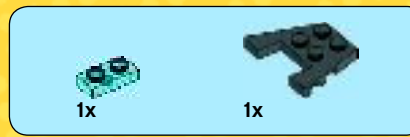
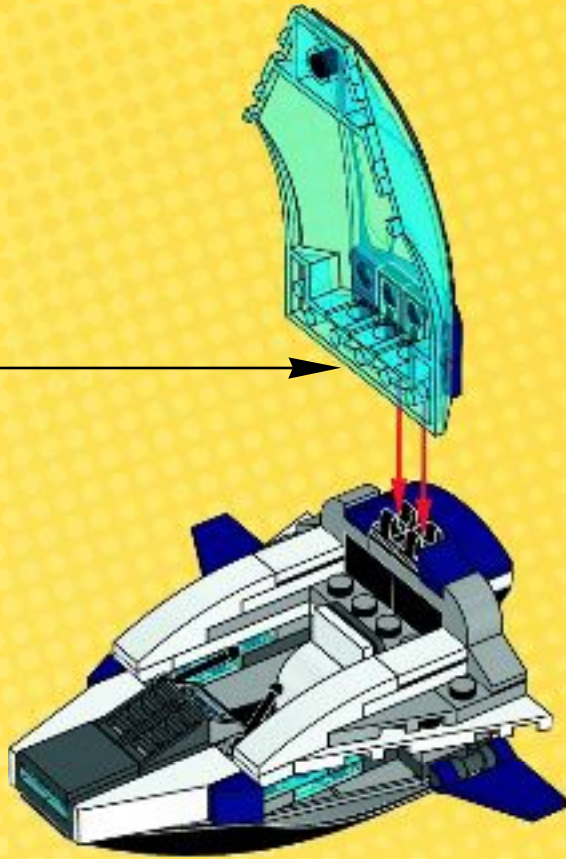

23

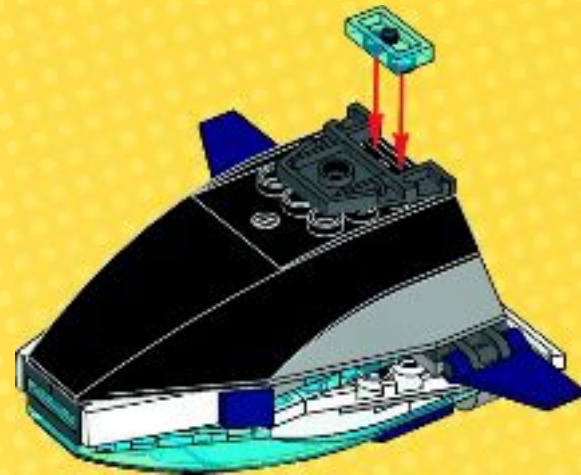



1x

24



1x



1x

25



52

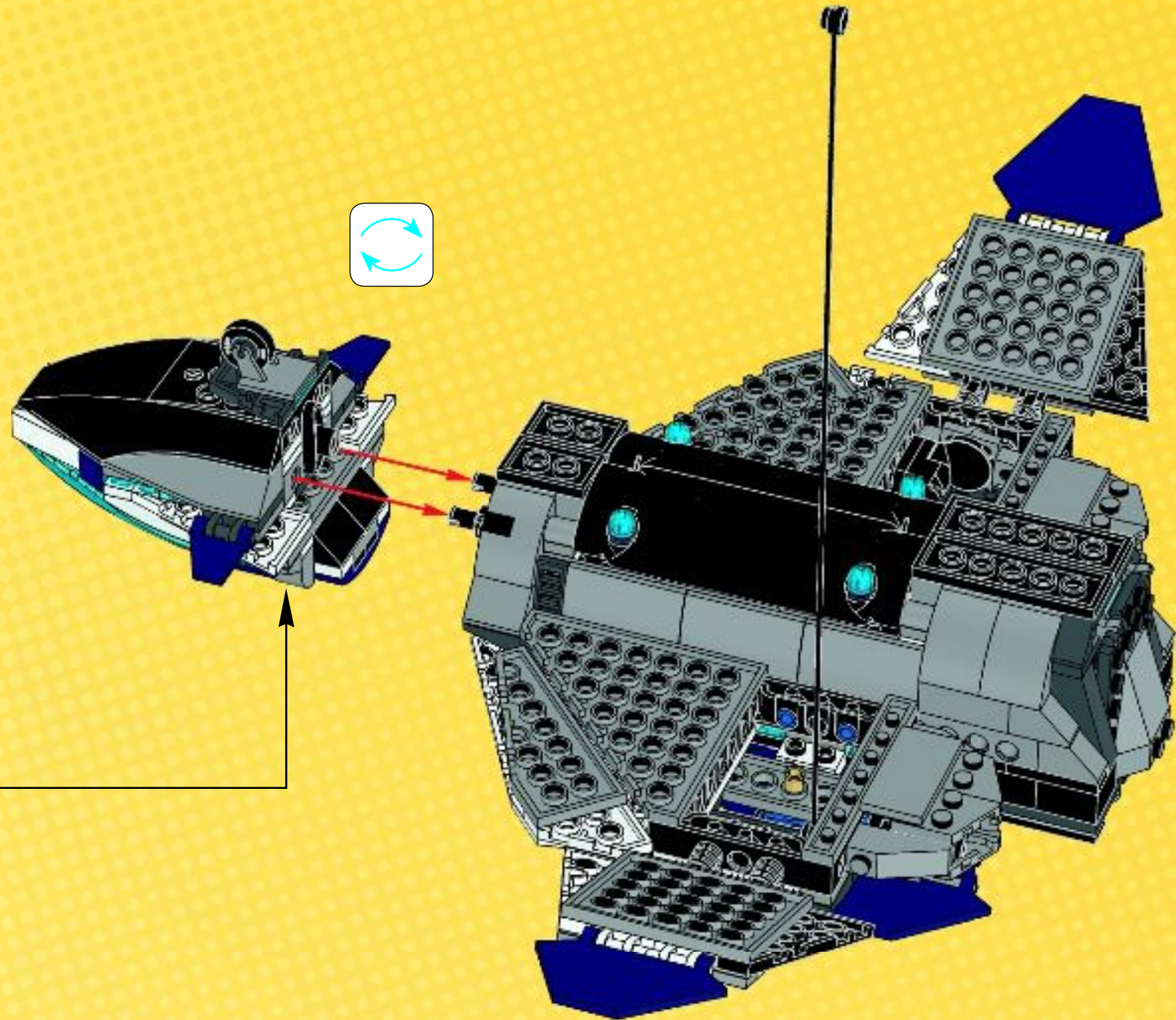



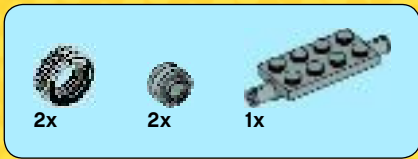

53

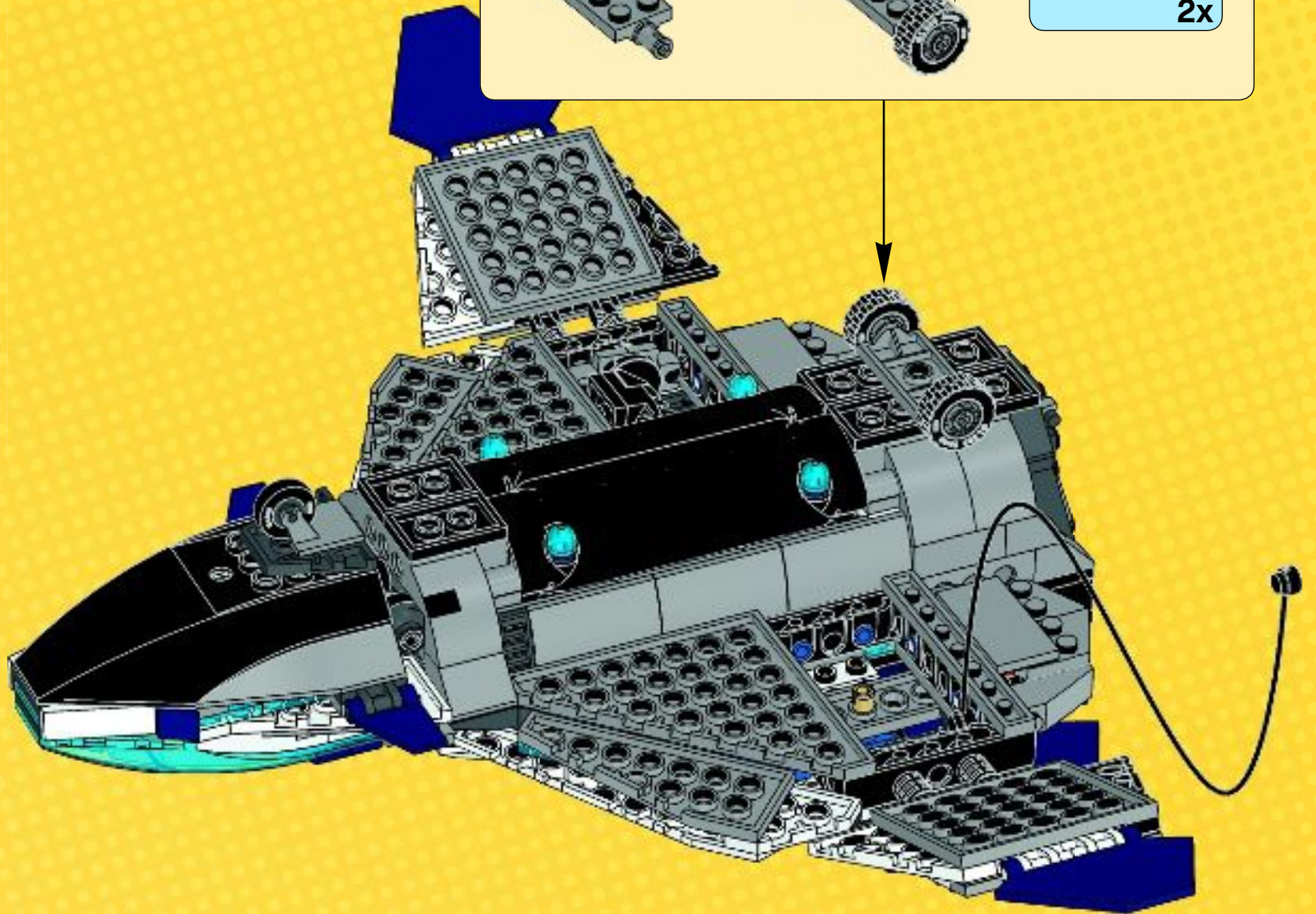
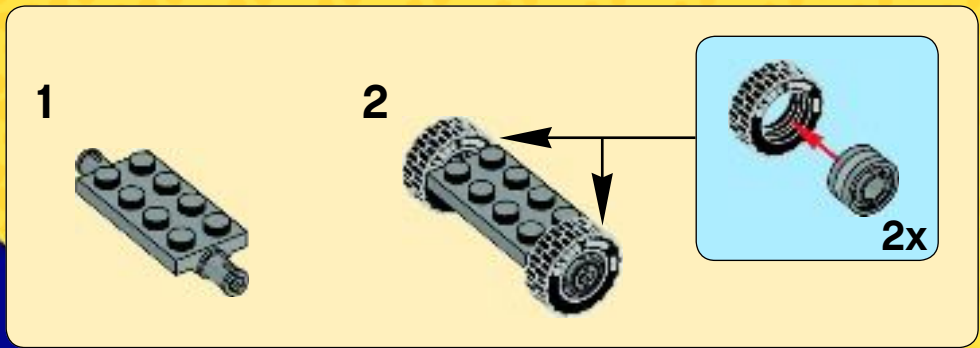

54

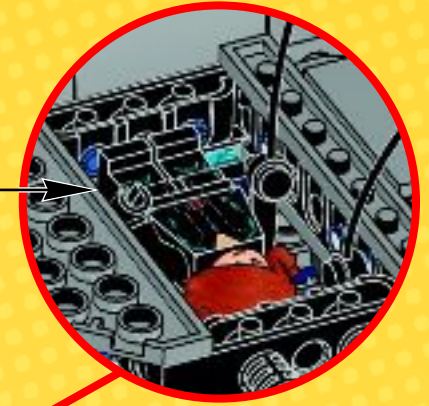
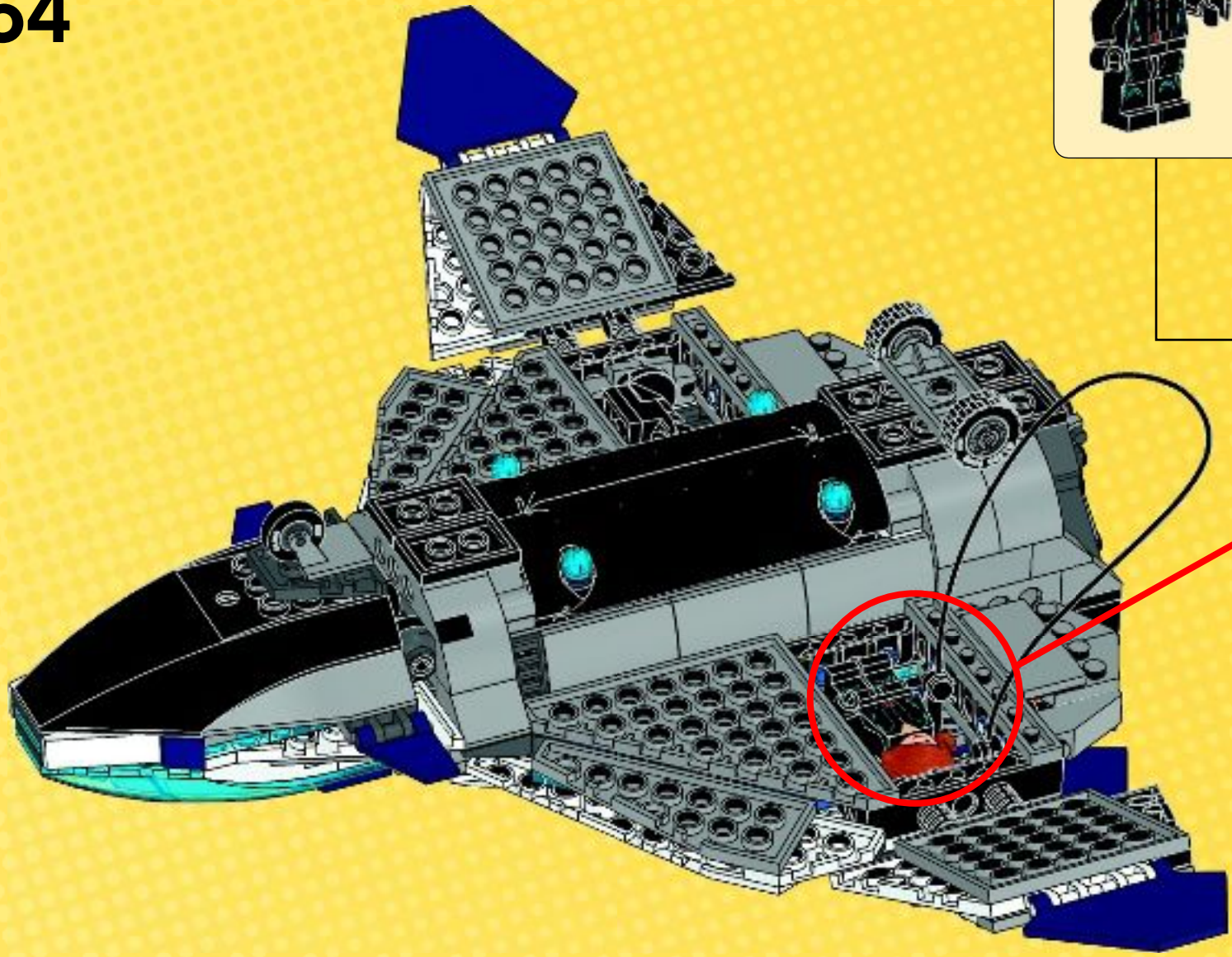

55

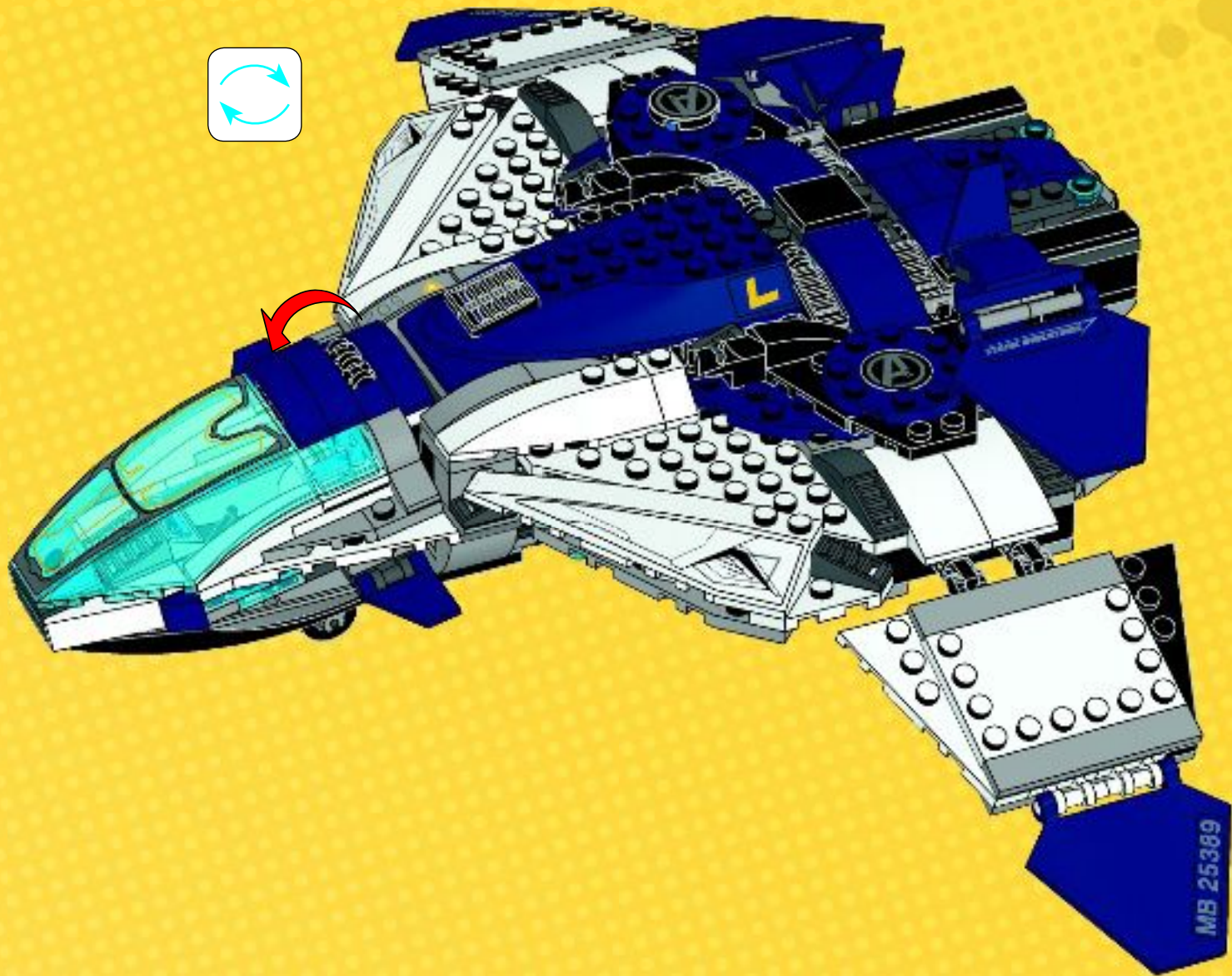



 2x 4567891	 2x 302101	 2x 4569056	 1x 287726	 2x 4251161	 4x 4515368	 3x 6070695
 1x 3200001	 4x 371001	 1x 306221	 2x 235726	 4x 307026	 4x 4523339	 3x 4278359
 2x 4121932	 1x 302001	 1x 459921	 2x 362326	 4x 306926	 1x 6051038	 1x 4283047
 4x 4515359	 3x 379501	 1x 6071464	 3x 302126	 5x 302326	 4x 6066102	 1x 4283046
 2x 6045936	 2x 4163986	 1x 4220515	 6x 292126	 1x 306826	 4x 4550017	 1x 4283046
 4x 6031947	 2x 4249563	 2x 4142865	 2x 4535765	 2x 302226	 6x 4598528	 3x 4531412
 1x 608101	 4x 4140583	 6x 6072633	 2x 4213374	 2x 4565323	 4x 4515340	 1x 6092446
 1x 4160101	 2x 4515364	 1x 371023	 2x 654126	 4x 242026	 5x 6020193	 1x 6024113
 1x 4160124	 2x 4287707	 4x 403223	 2x 4180508	 4x 4599499	 2x 4140588	 1x 6024114
 2x 307001	 17x 4143005	 17x 4143005	 2x 4180536	 1x 371026	 1x 4225201	 1x 6024114
 8x 302401	 4x 4206482	 4x 4206482	 2x 4180536	 3x 6064228	 2x 663626	 1x 658326
 4x 4514553	 2x 4287708	 2x 4287708	 2x 4180536	 2x 4529549	 3x 379526	 1x 6114300
 2x 245001	 2x 245001	 3x 371024	 1x 281726	 3x 6064228	 2x 4188143	 1x 6114067
 1x 6015477	 2x 6051511	 1x 302024	 1x 4548180	 1x 4541984	 4x 4107558	 1x 400626
 1x 6015474	 4x 306901	 1x 6119497	 2x 4121966	 2x 611226	 2x 244526	 1x 4516843
 2x 4585737	 4x 6093526	 1x 4239601	 2x 366026	 1x 4209683	 2x 4617848	 2x 4617848

- 4x 4568644
- 2x 6064174
- 1x 6104030
- 1x 73081
- 4x 4648117
- 1x 6108553
- 1x 4542671
- 6x 4541191
- 4x 4159335
- 4x 6102734
- 1x 6096956
- 2x 4112287
- 2x 4530578

- 1x 4184169
- 12x 4121715
- 1x 6055630
- 1x 370526
- 1x 6115306
- 2x 4650498
- 1x 4613756
- 1x 6093683
- 4x 4611639
- 2x 4244363
- 2x 4190187
- 3x 4183544
- 3x 4163917
- 27x 4260426
- 2x 4266417
- 12x 3005743
- 1x 6089633

- 4x 4497952
- 3x 4194746
- 3x 4153989
- 3x 3005747
- 1x 6112735
- 2x 4179833
- 2x 6056214
- 1x 6114071
- 4x 4504374
- 5x 6061569
- 3x 6037886
- 1x 6097430
- 2x 6056662
- 1x 4173328
- 1x 4654448

- 2x 4528488
- 3x 4613335
- 2x 6108550
- 4x 6023154
- 4x 4529551
- 4x 6106179
- 1x 4162916
- 1x 6109389
- 1x 6109387
- 1x 6114180
- 1x 6114075
- 1x 6111232
- 1x 6111158
- 1x 6023972

- 1x 6107539
- 1x 6008350
- 2x 4542673
- 2x 4211389
- 2x 4211388
- 2x 4211428
- 4x 4211476
- 2x 4211440
- 1x 4211660
- 5x 4211441
- 1x 4211676
- 2x 4521921
- 2x 4568637
- 2x 4211374

- 4x 4211437
- 4x 4211436
- 4x 4211488
- 1x 6030235
- 2x 4211519
- 4x 4251163
- 4x 4622803
- 6x 4597901
- 2x 4618874
- 3x 6070267
- 1x 4260935
- 1x 4260934
- 1x 4211350
- 2x 4211398
- 4x 4211397



  
**Customer Service**  
**Kundenservice**  
**Service Consommateurs**  
**Servicio Al Consumidor**  
**LEGO.com/service or dial**  

**: 00800 5346 5555**  
**: 1-800-422-5346**

# WIN

GO TO [WWW.LEGO.COM/PRODUCTFEEDBACK](http://WWW.LEGO.COM/PRODUCTFEEDBACK) AND GIVE US YOUR SHORT **FEEDBACK** ABOUT THIS LEGO® SET FOR A CHANCE TO WIN A COOL LEGO PRIZE.



## LEGO.com/productfeedback

### GEWINNE



Erzähle uns auf [www.LEGO.com/productfeedback](http://www.LEGO.com/productfeedback)

etwas über die Erfahrungen, die du mit diesem LEGO® Set gemacht hast, und sichere dir die Chance auf einen coolen LEGO Preis!

### GAGNE



Rends-toi sur [www.LEGO.com/productfeedback](http://www.LEGO.com/productfeedback)

et donne-nous quelques commentaires sur ce produit LEGO® pour avoir une chance de gagner un prix LEGO !

### GANAN



Visita [www.LEGO.com/productfeedback](http://www.LEGO.com/productfeedback)

y envíanos tu opinión acerca de este set LEGO®. ¡Participarás en el sorteo de un premio LEGO!

### 获取奖品



登录 [www.LEGO.com/productfeedback](http://www.LEGO.com/productfeedback)

给出关于此乐高®套装的简短反馈，就有机会获得炫酷乐高奖品

### 경품 당첨 기회



[www.LEGO.com/productfeedback](http://www.LEGO.com/productfeedback)

페이지로 이동하여 이 레고® 세트에 대한 간략한 피드백을 보내 주시고 멋진 레고 경품을 탈 수 있는 기회도 잡으십시오

### ЗАПОЛНИ АНКЕТУ И ПОЛУЧИ ПРИЗ



Перейди по ссылке [www.LEGO.com/productfeedback](http://www.LEGO.com/productfeedback)

ответь всего на несколько вопросов об этом наборе LEGO®, и у тебя появится шанс выиграть замечательный приз от компании LEGO.