



ELVES

41077



1



2



3



4



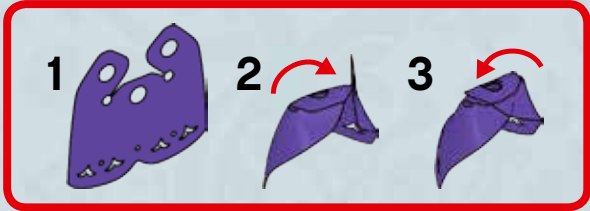
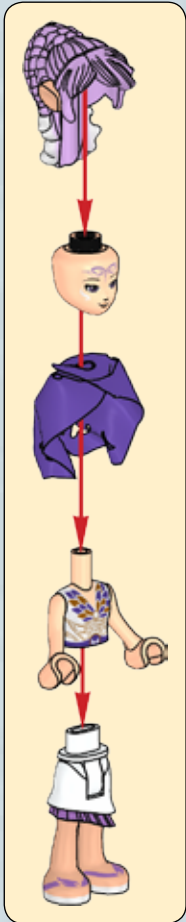

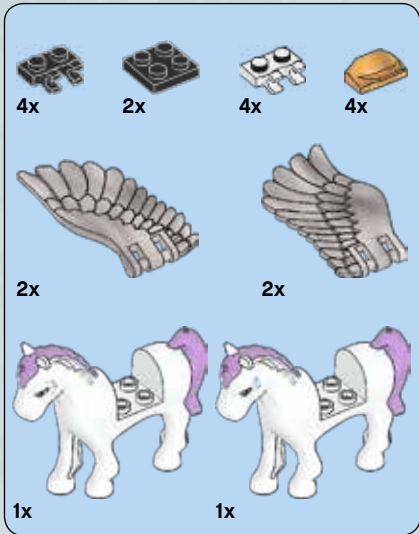

1



2



4



5

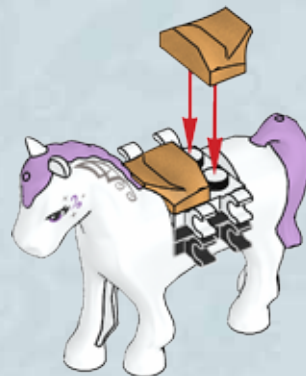

1

3

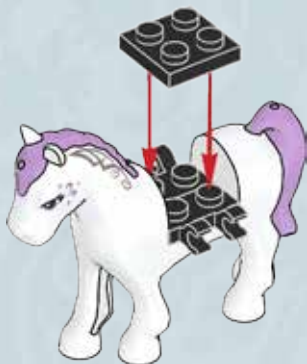

6

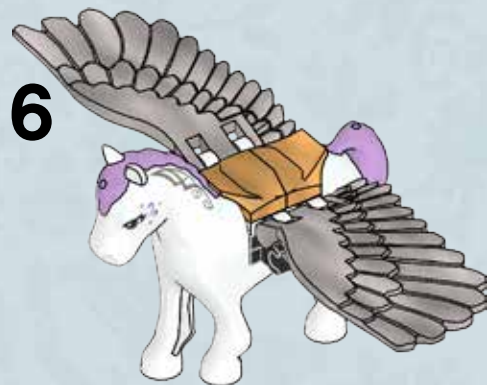

2x

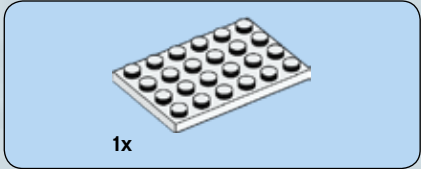
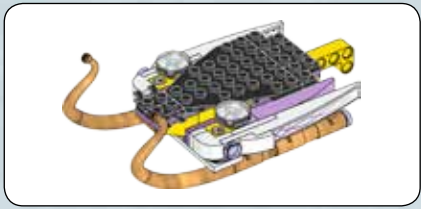

1



2

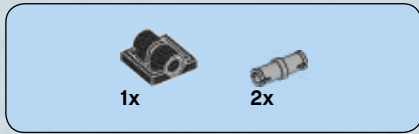
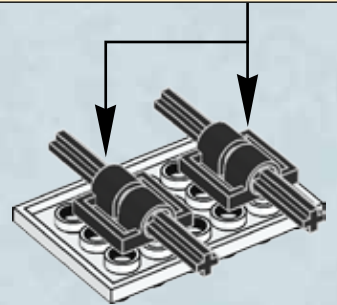
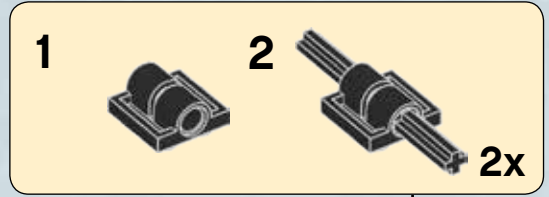

3

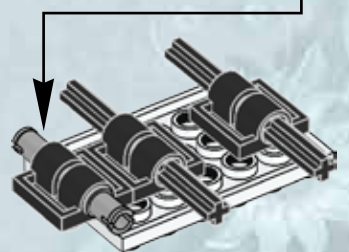
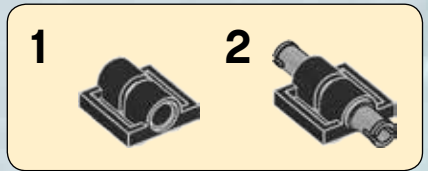

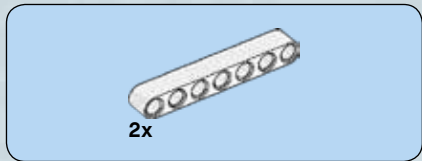

4

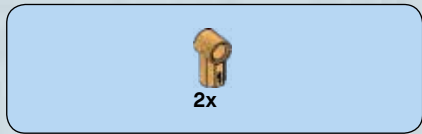
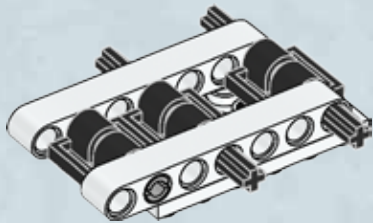

5

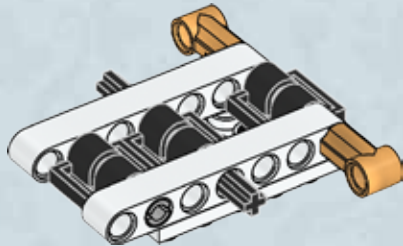



6

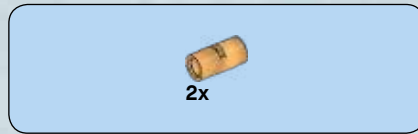
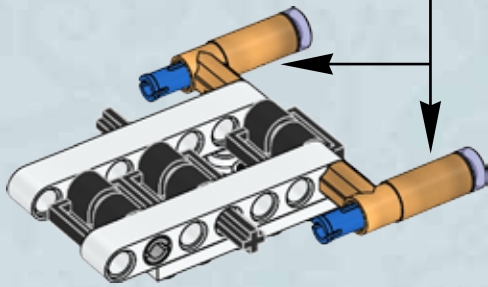
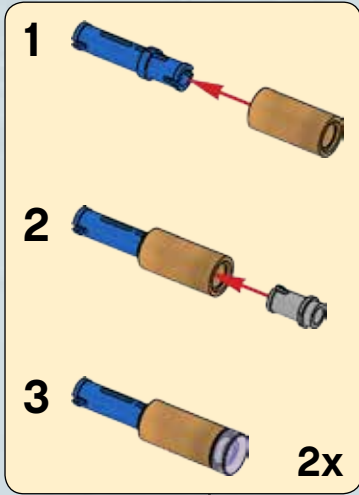

7

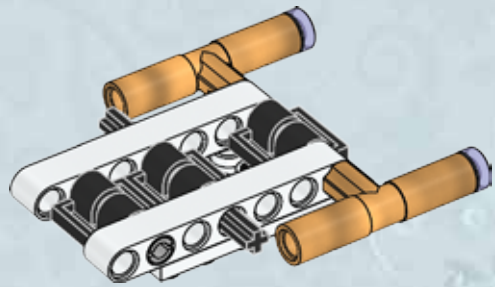



2x

8

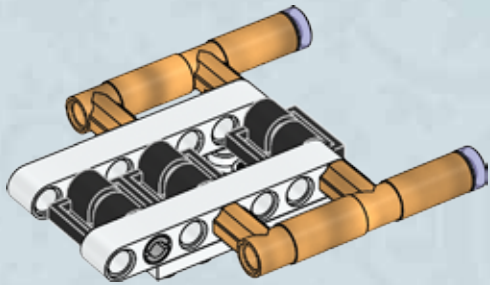

2x



2x

9

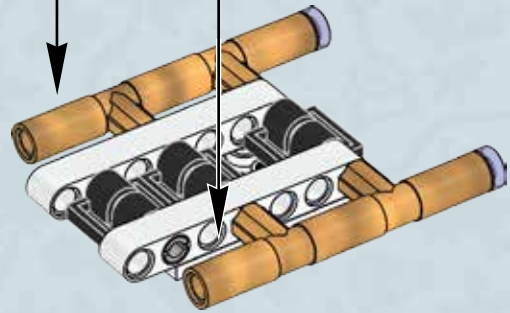
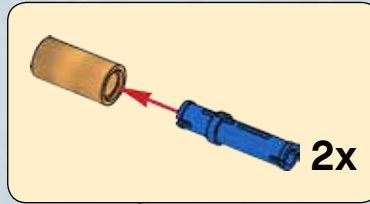

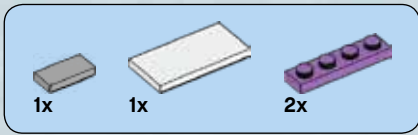

10

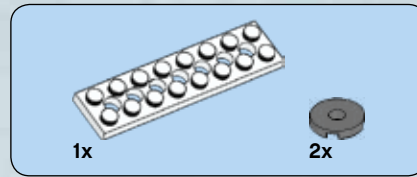
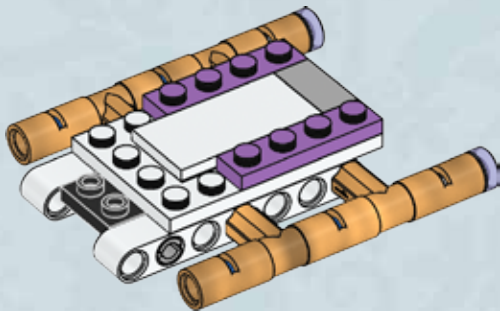

11

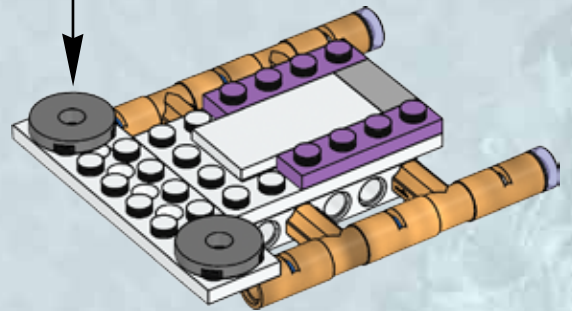
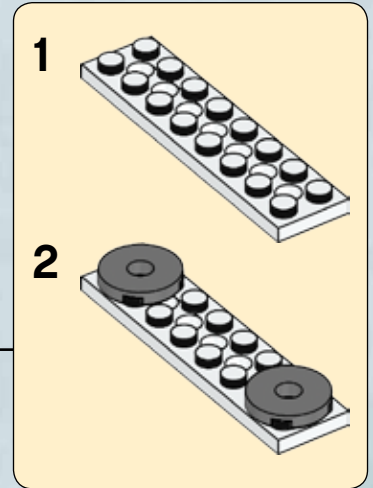



1x



2x

12

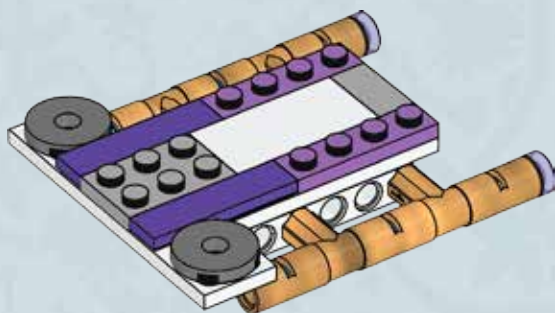

2x



2x

13

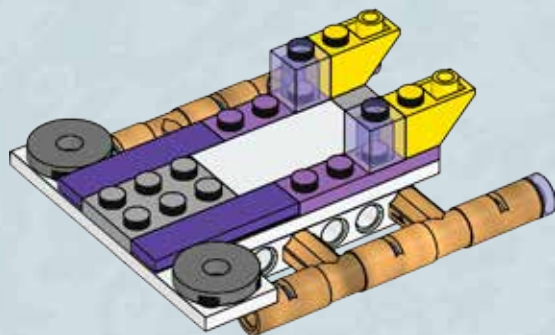



2x



4x

14

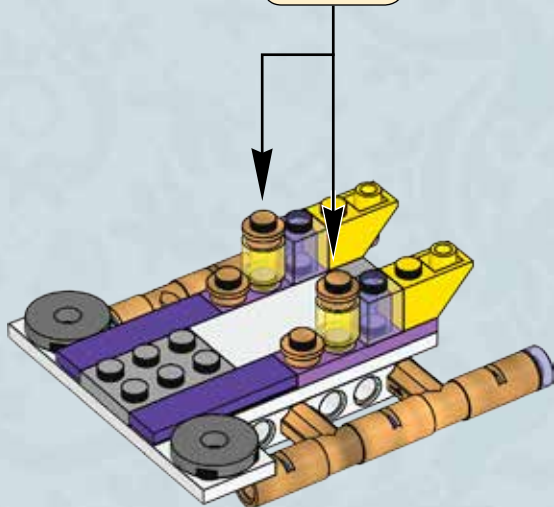
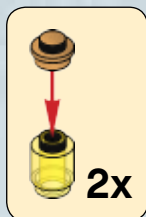

2x



1x



1x

15

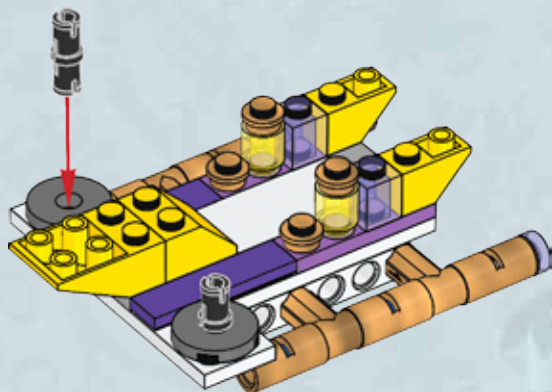

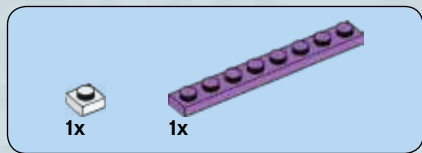

1

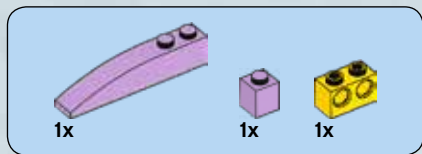
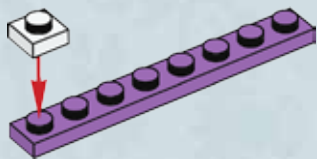

2

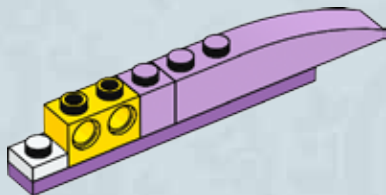

3

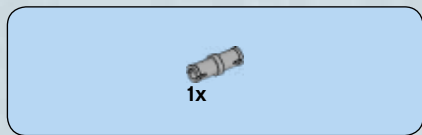
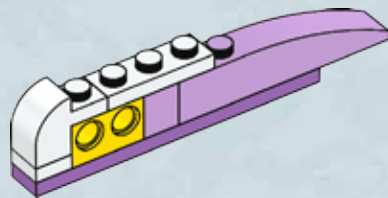

4

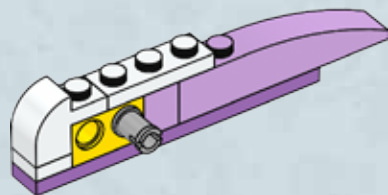

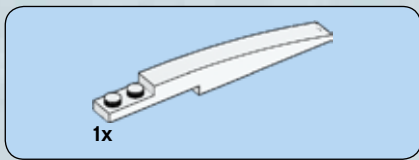

5

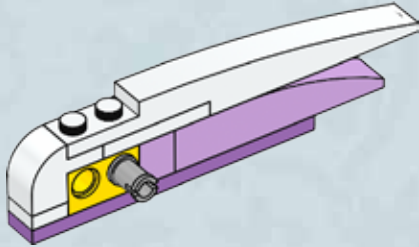

6

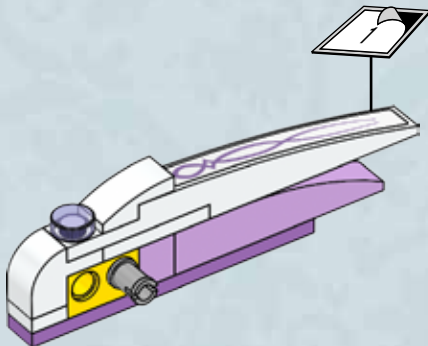

16

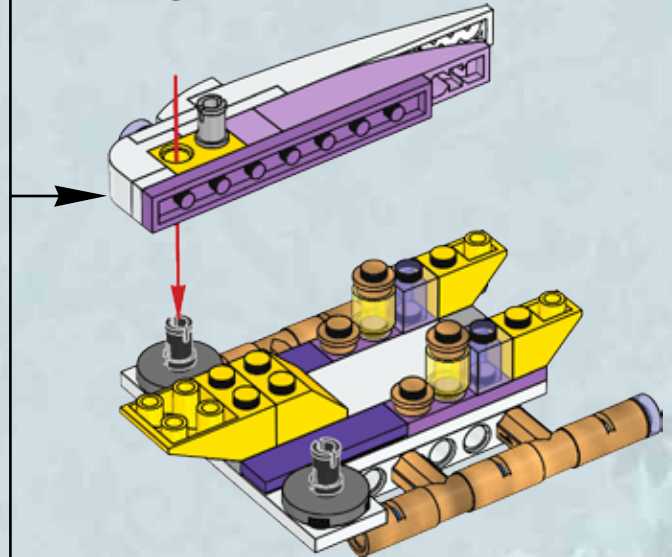

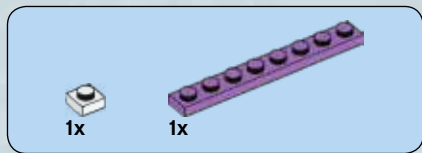

1

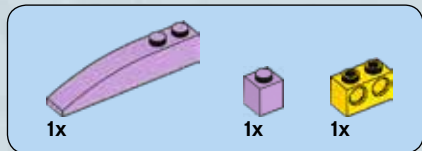
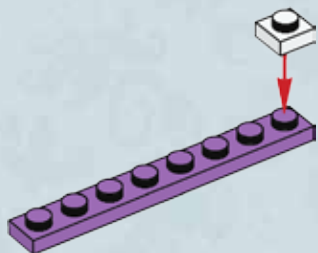

2

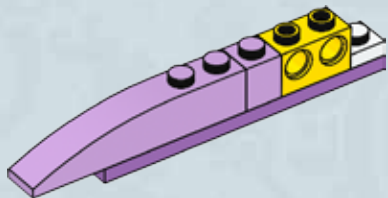

4

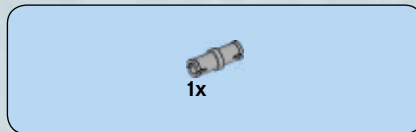
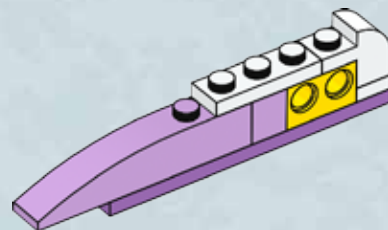

3

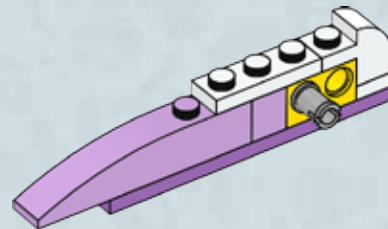

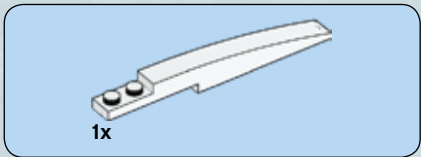

5

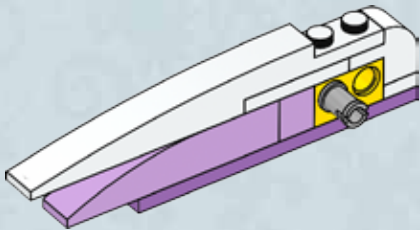

6

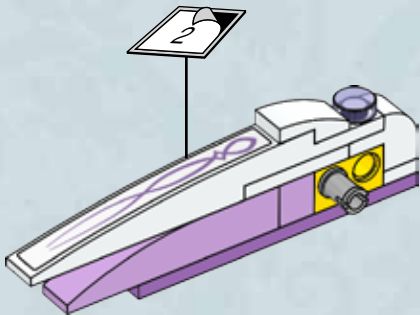

17

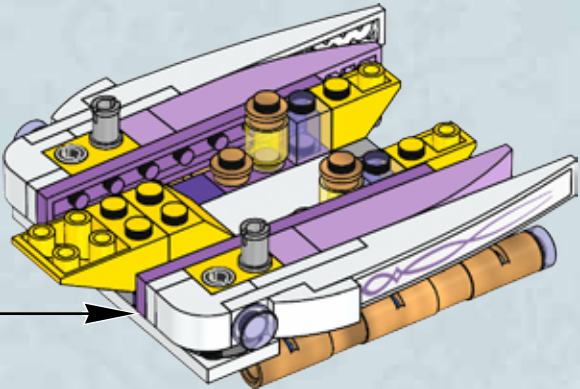



1x

1



1x

2

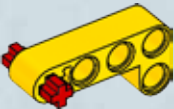

2x

3



1x

4





1x

5



2x

6

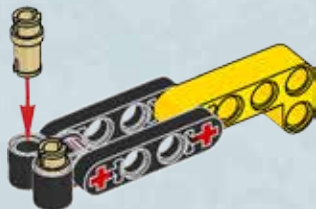

18

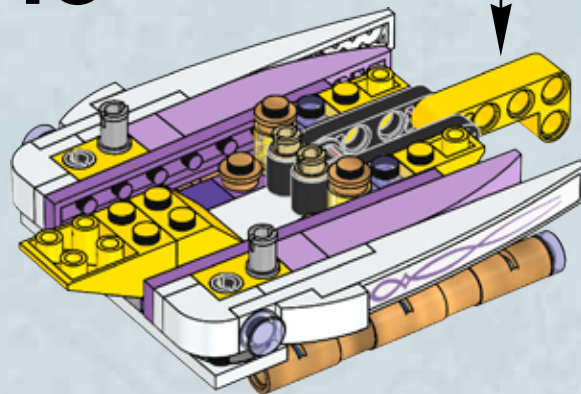

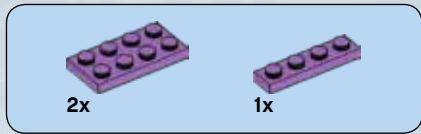

19

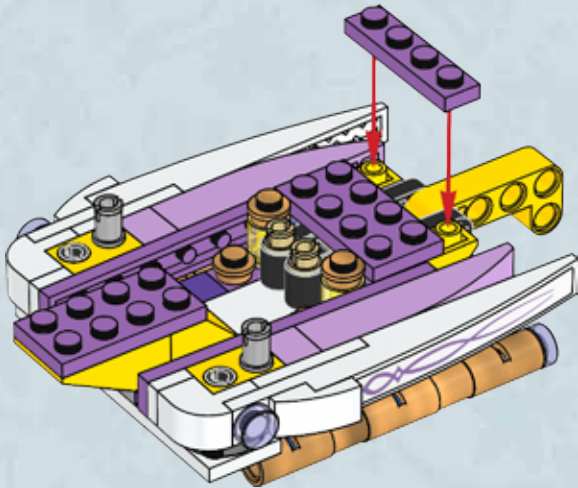

20

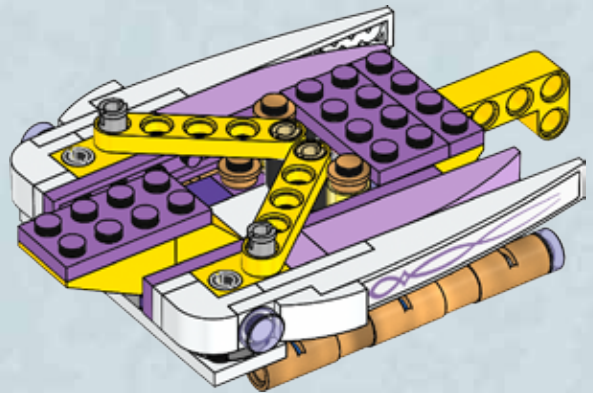

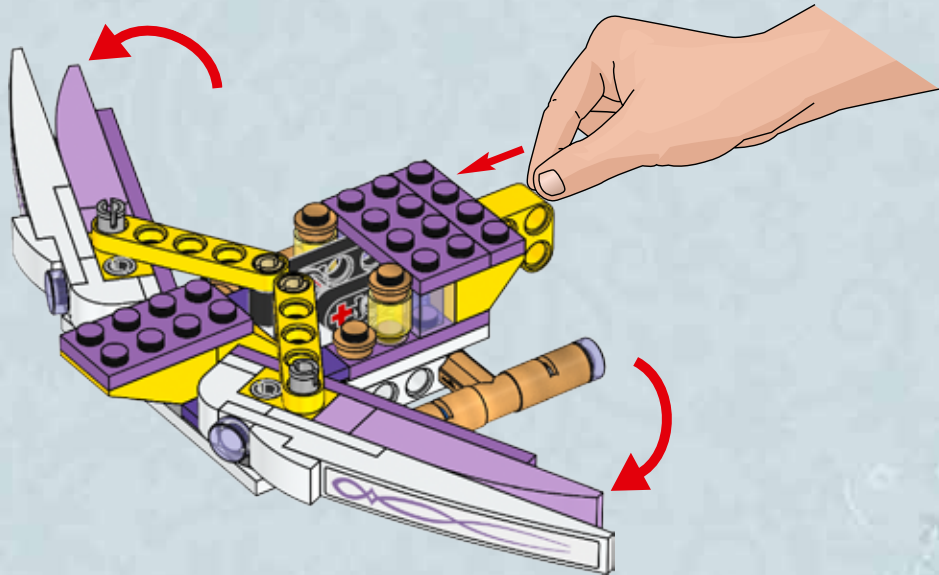
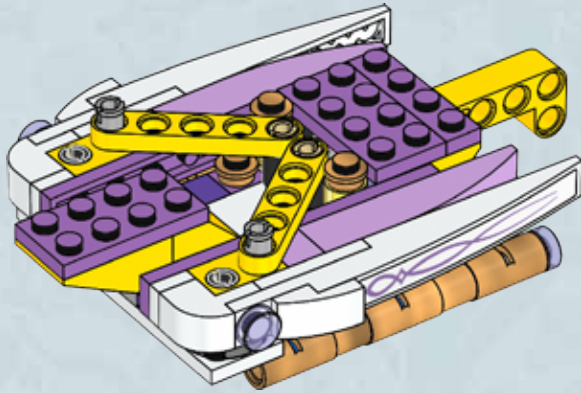



2x



2x

21

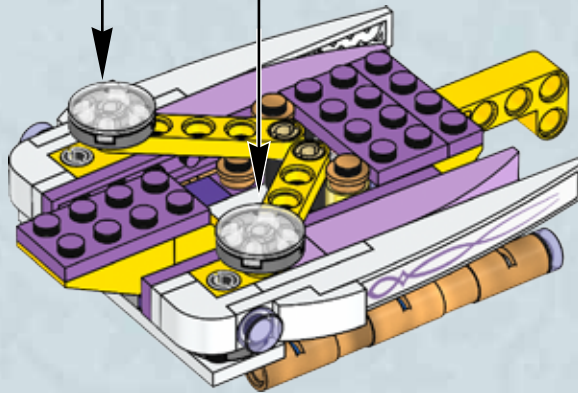
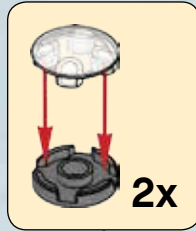



2x



1x

22

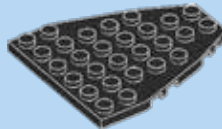
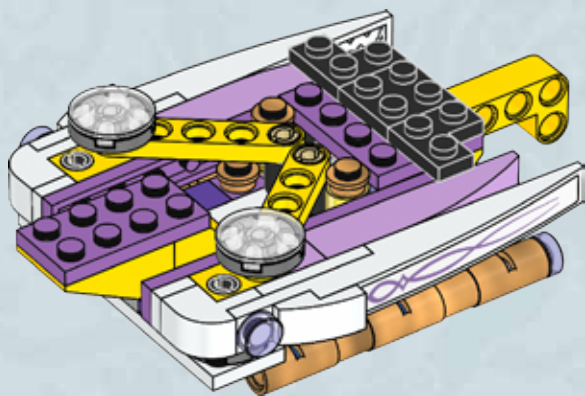

1x



2x

23

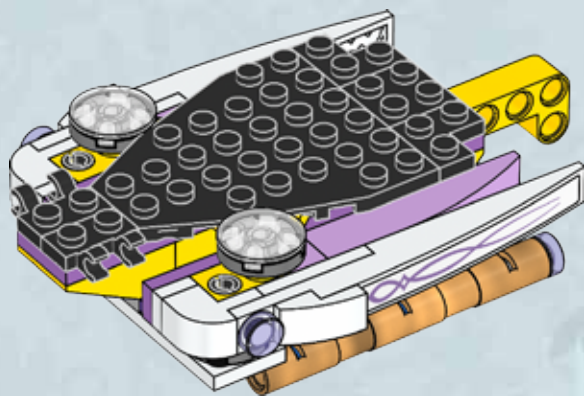



24

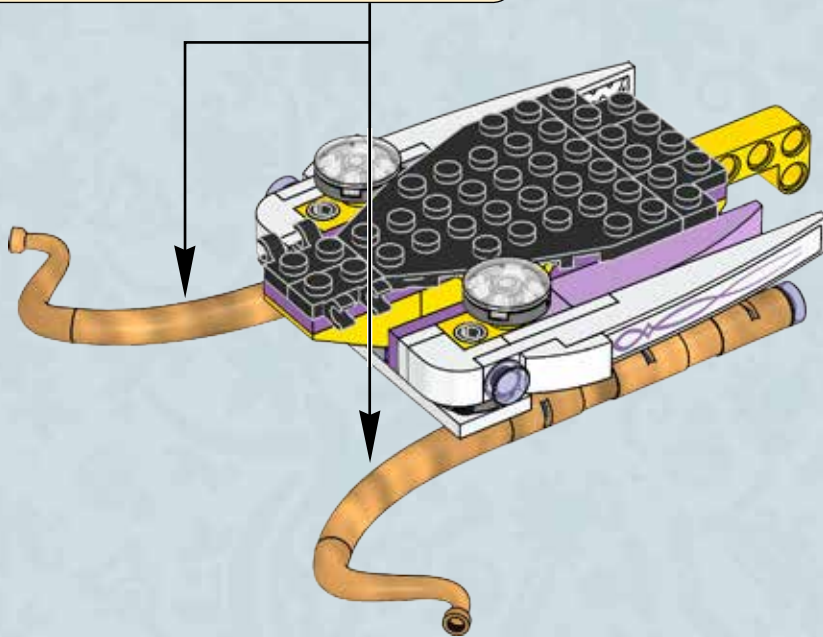
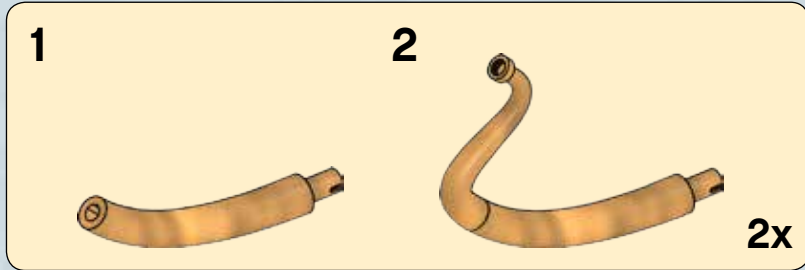

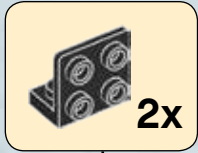

25

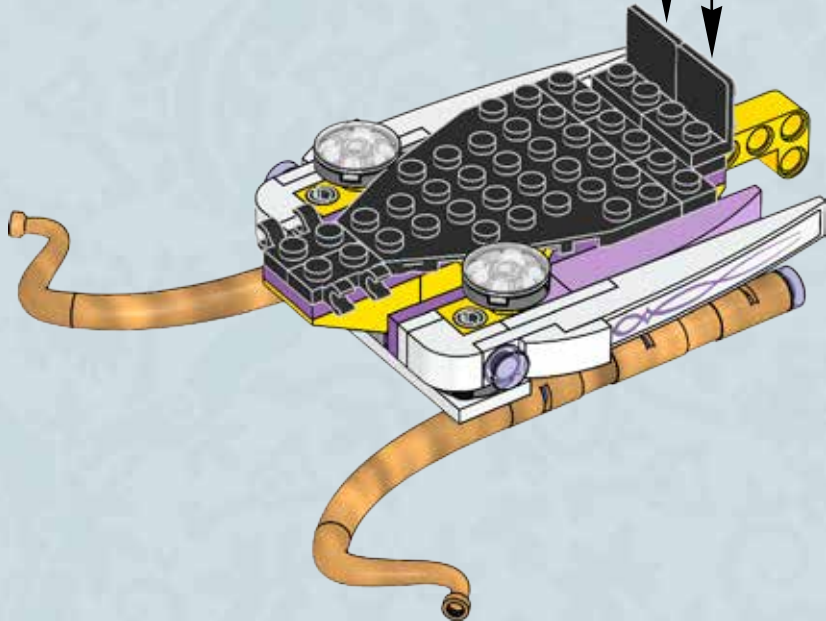

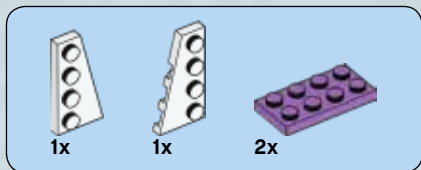

26

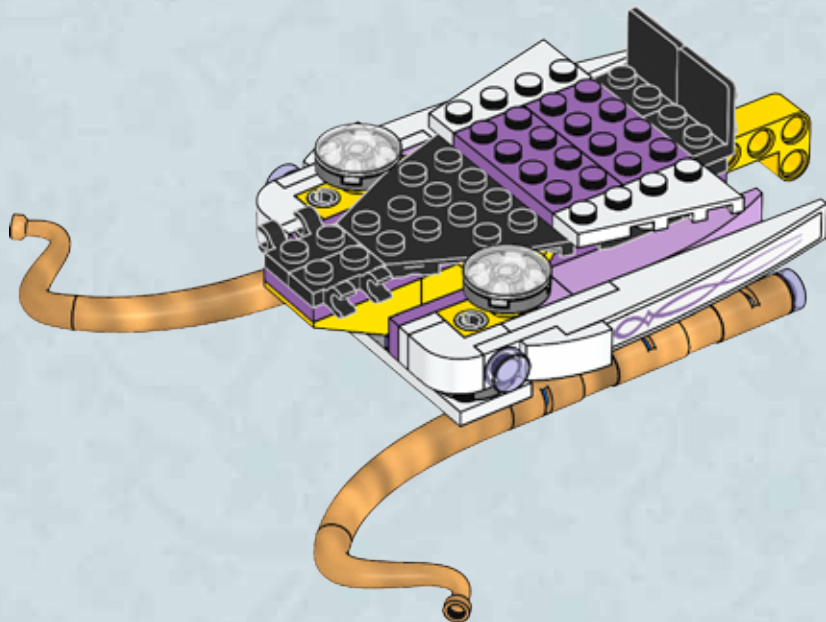

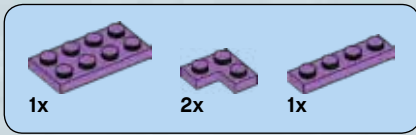

27

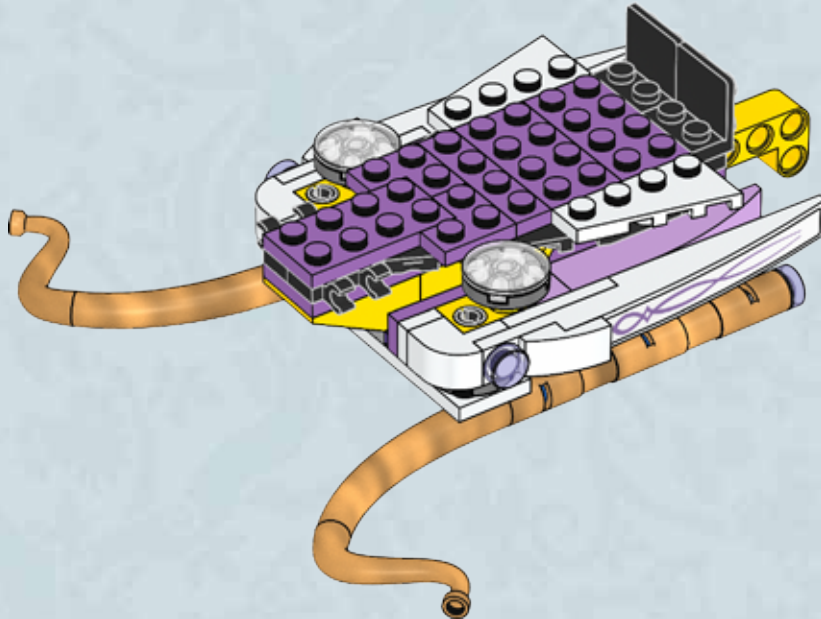

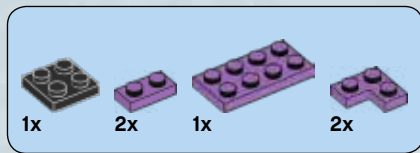

28

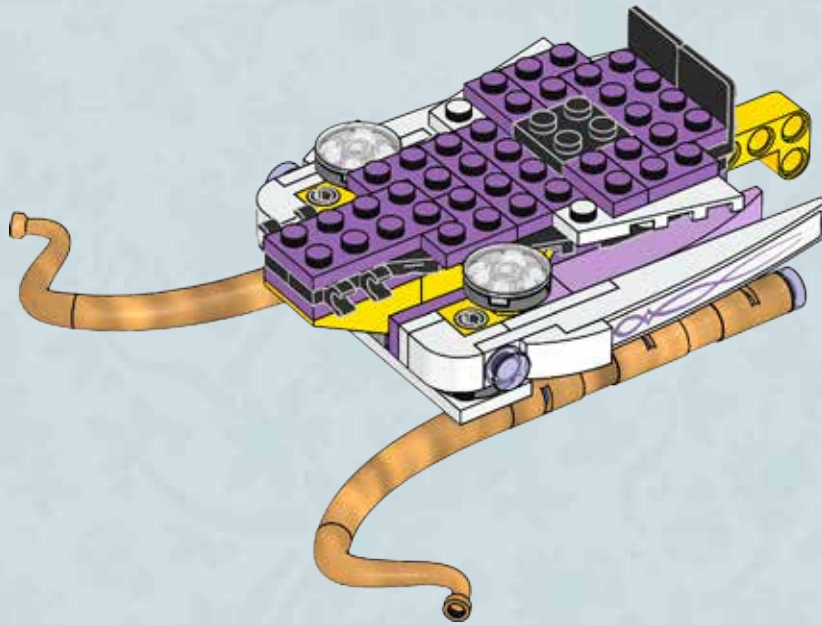



2x

29

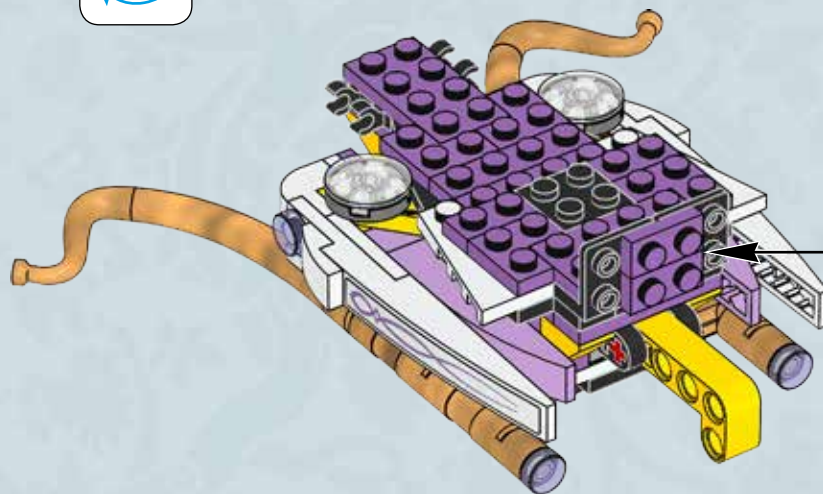
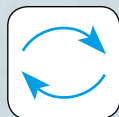

2x



30

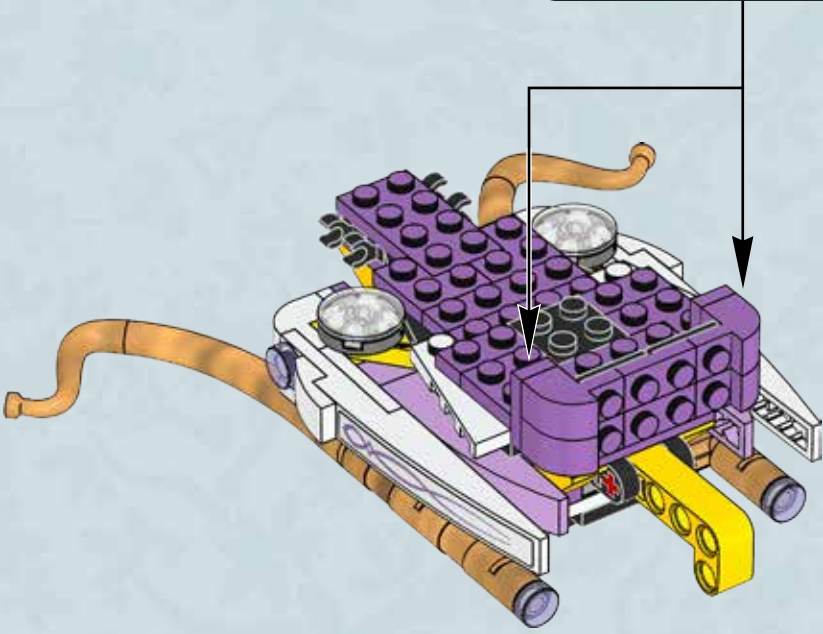
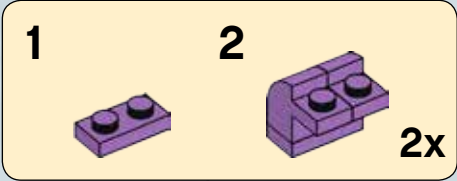



31

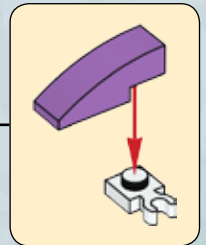
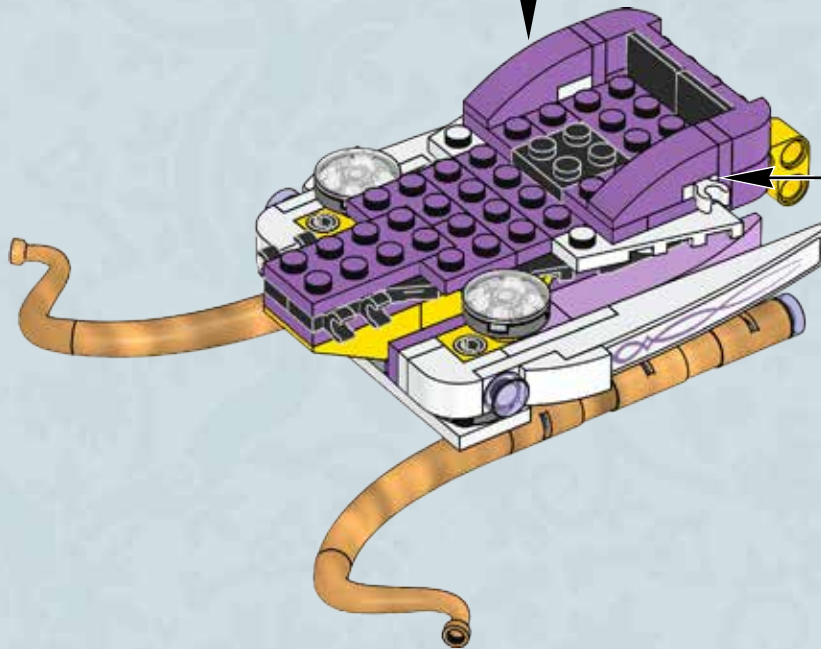
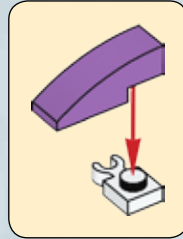
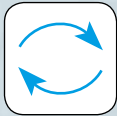

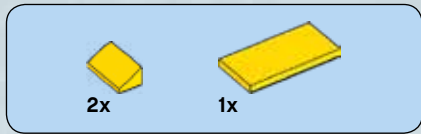

32

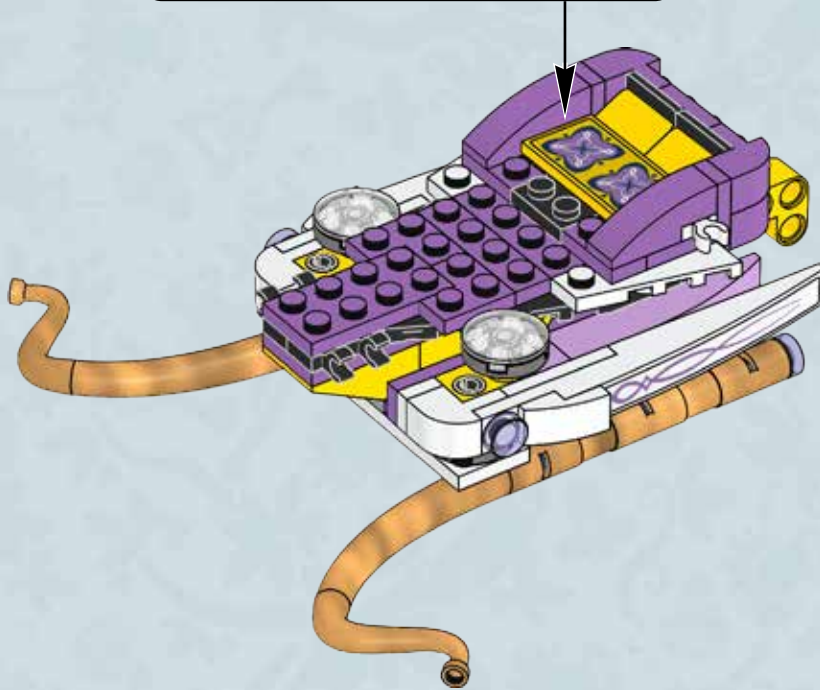
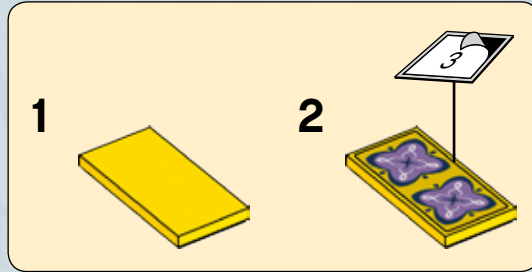



2x

33



2x

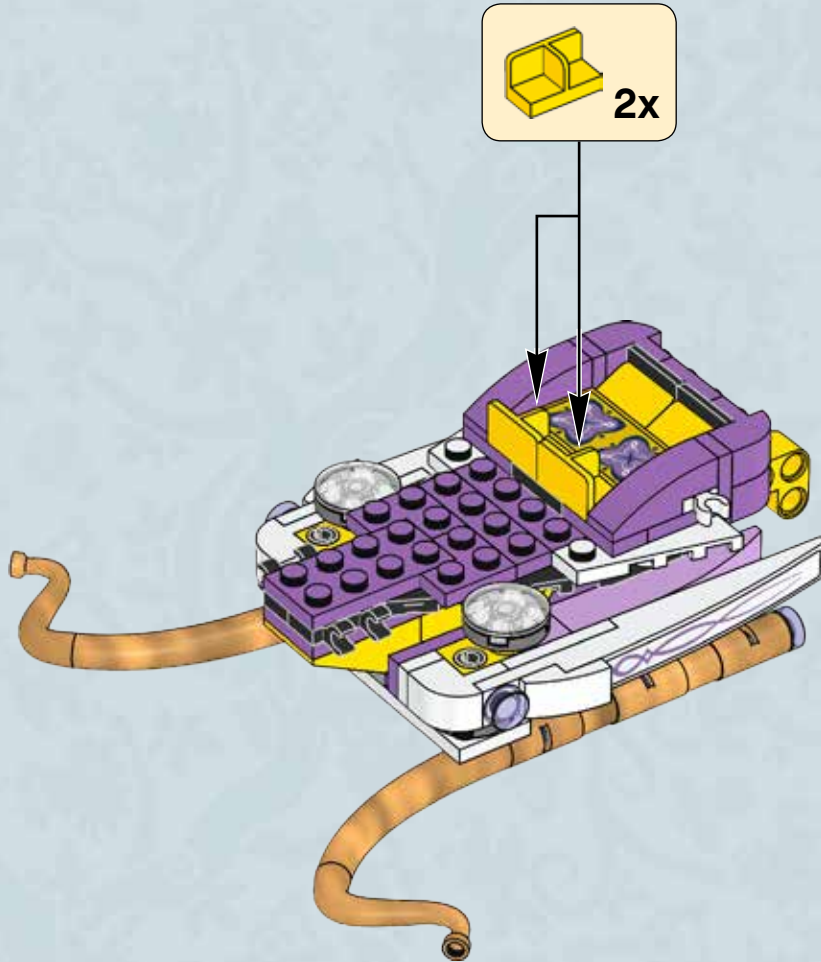

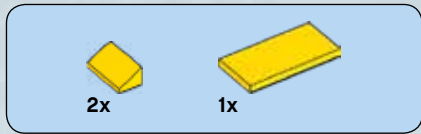

34

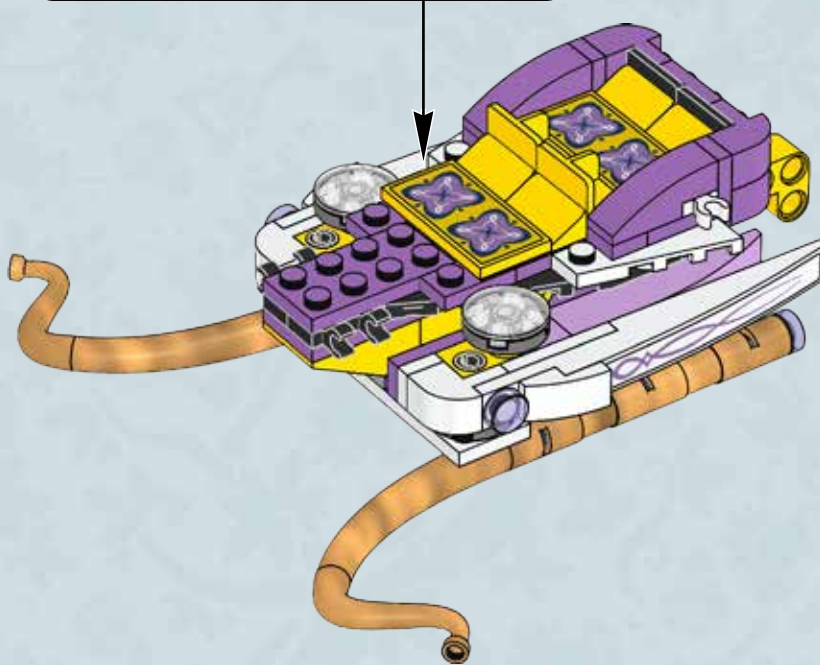
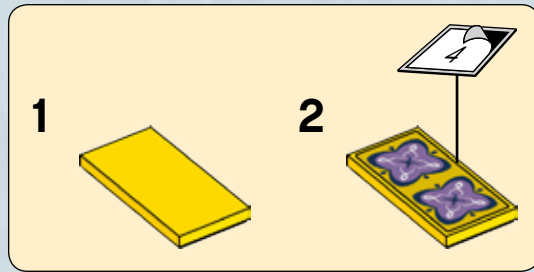



2x



2x

35

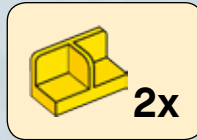

2x

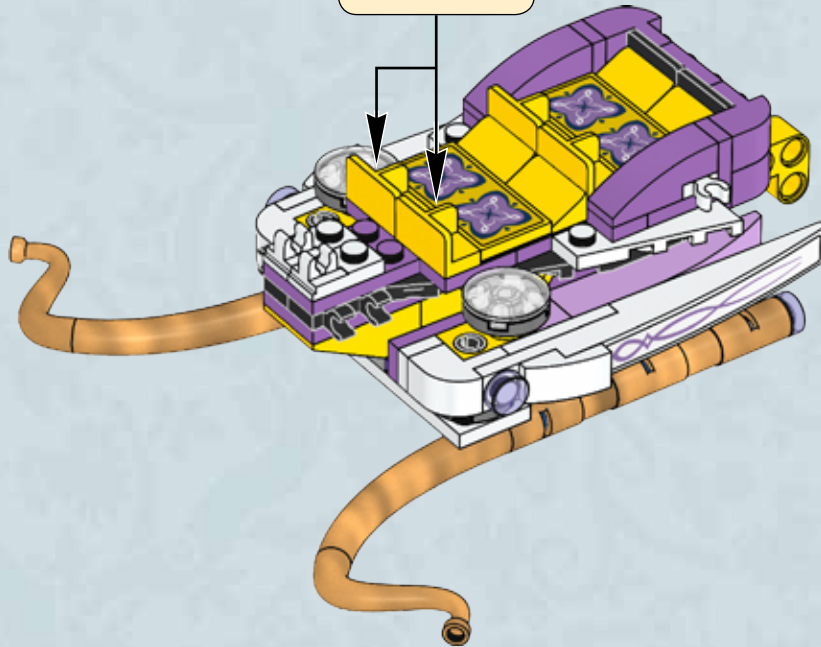

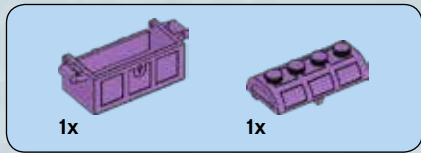

36

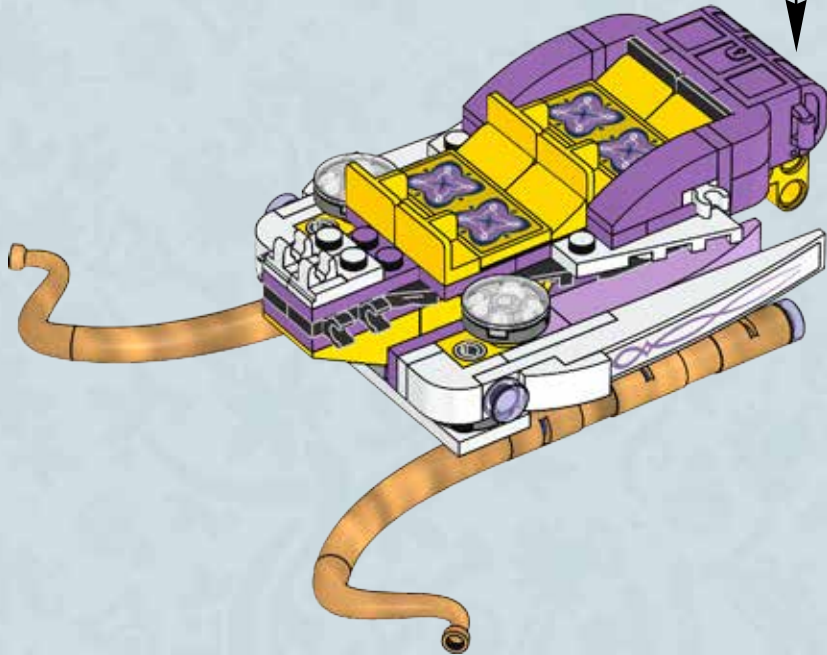
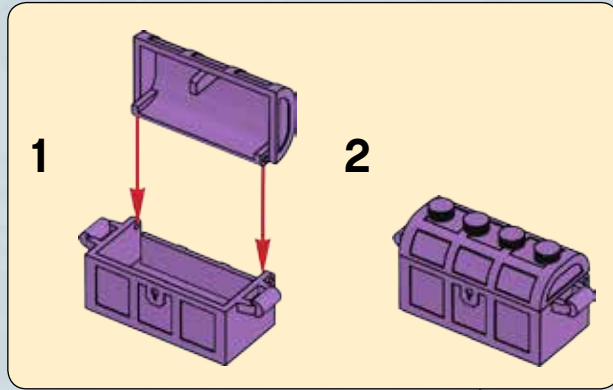



2x

37

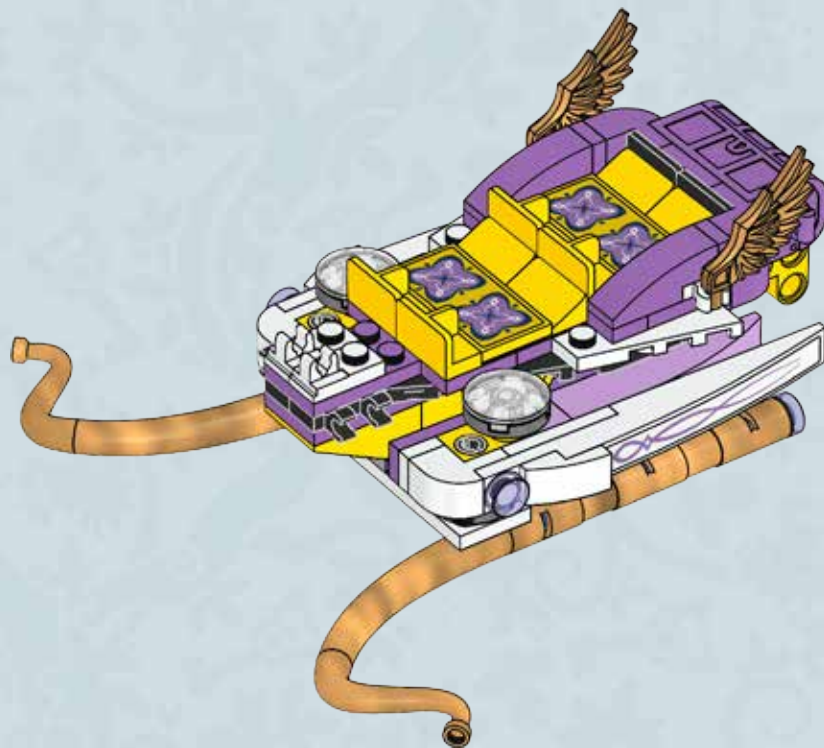

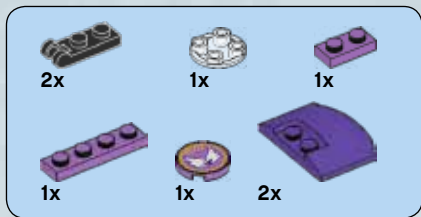

38

1

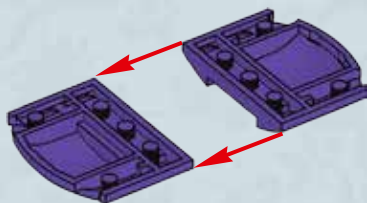

2

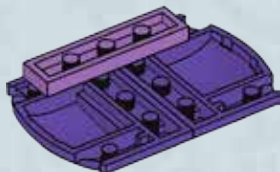

3

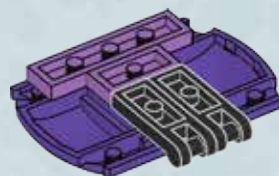

4



5



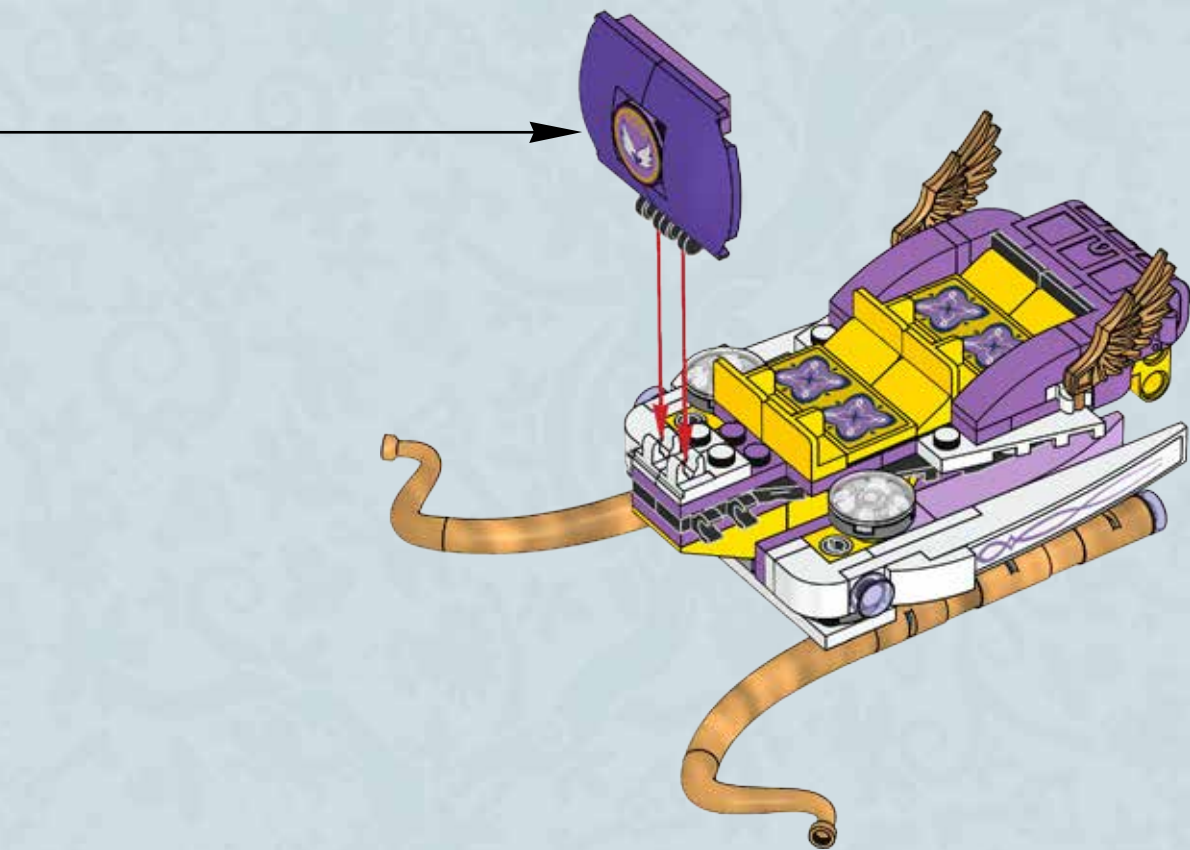

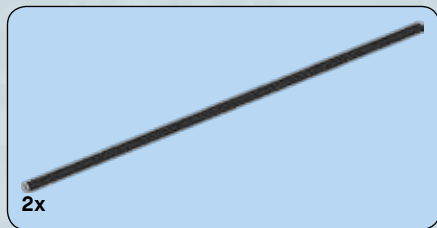

39

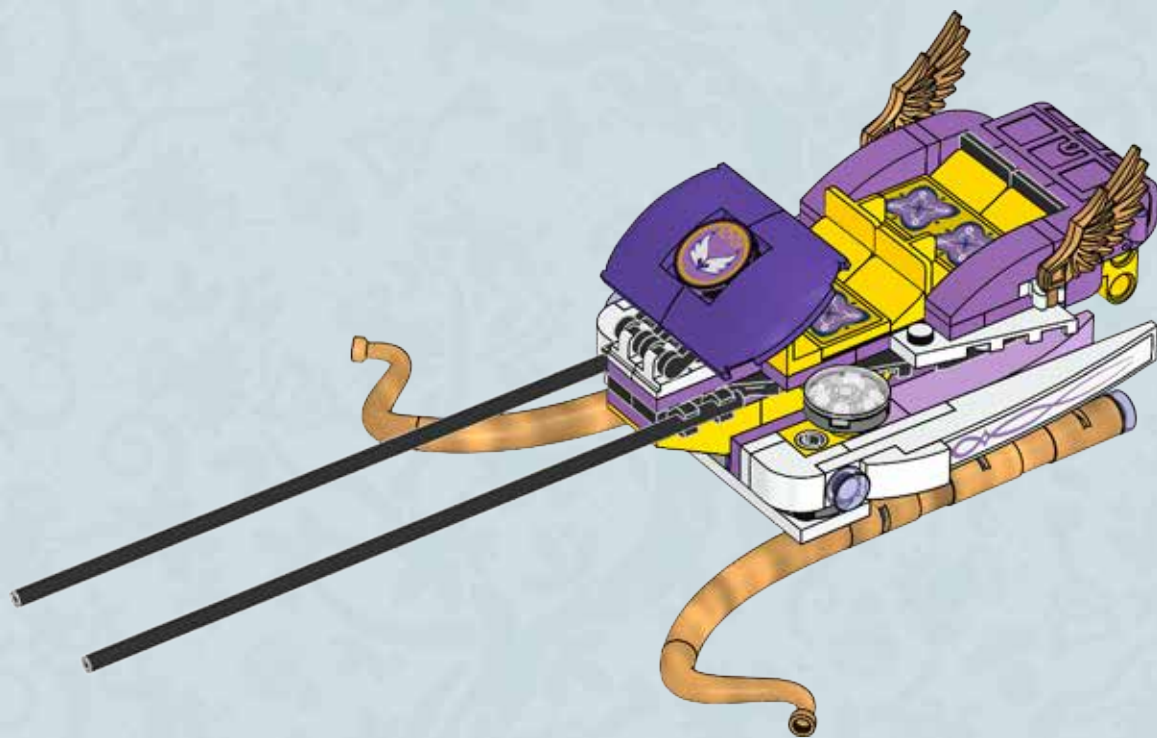

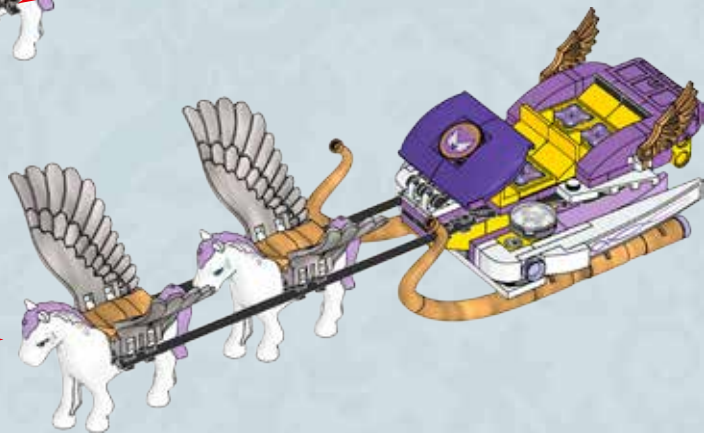
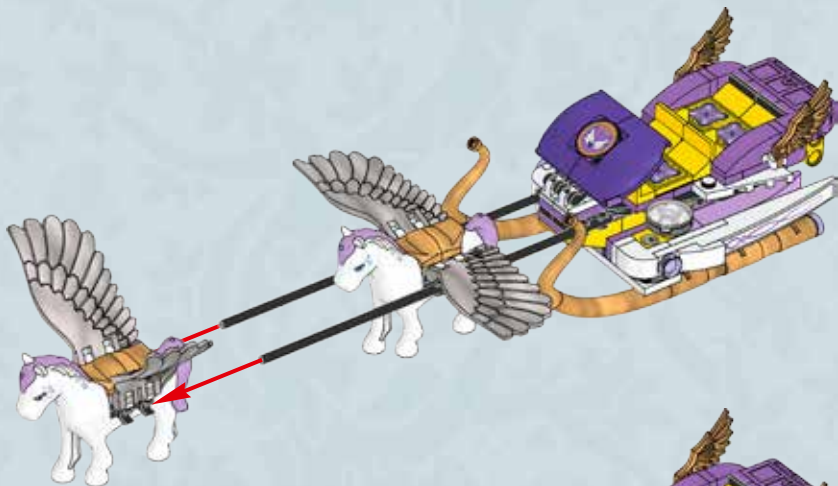
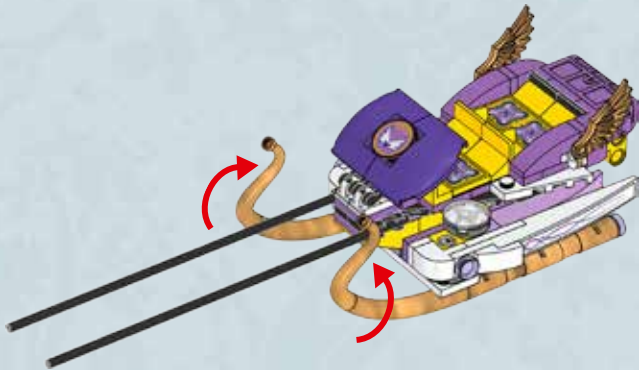

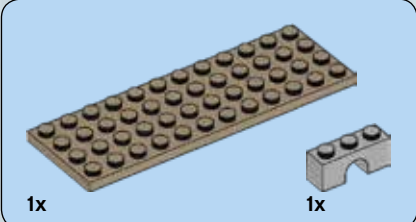

1

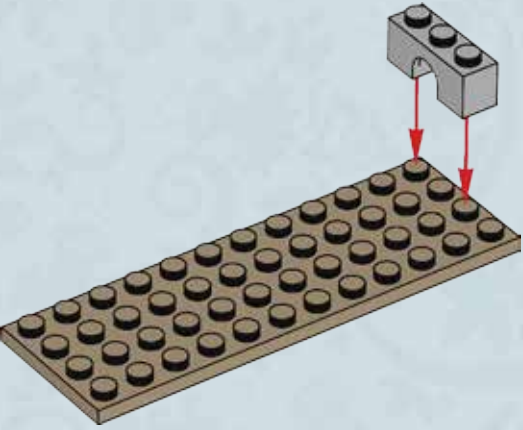

2

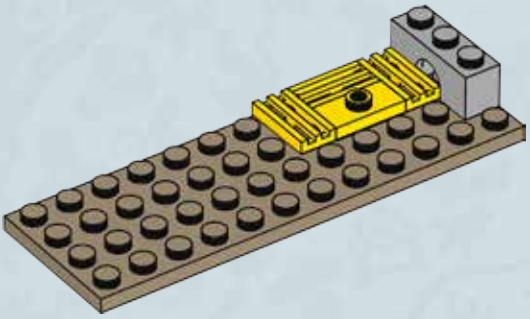

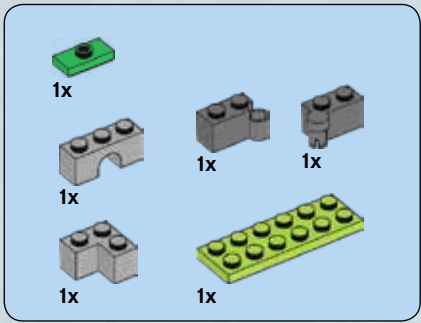

3

1

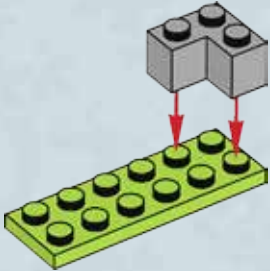

2

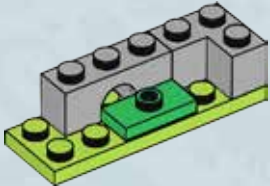

3

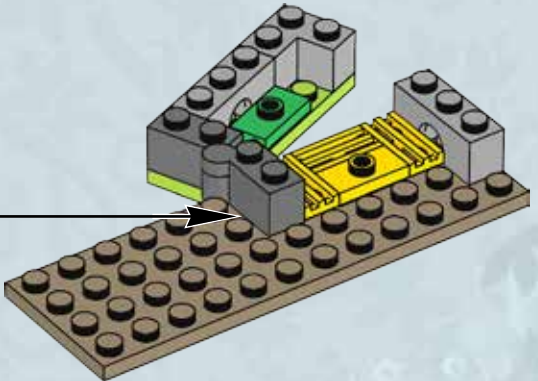
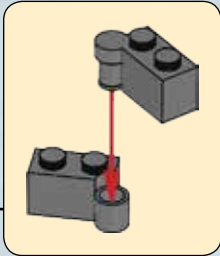
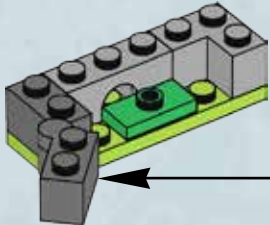



2x



1x

4

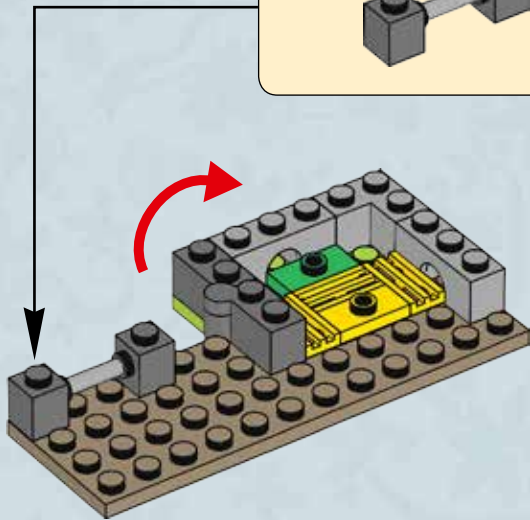
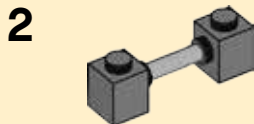
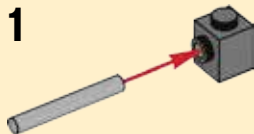

1:1



1x



1x

5

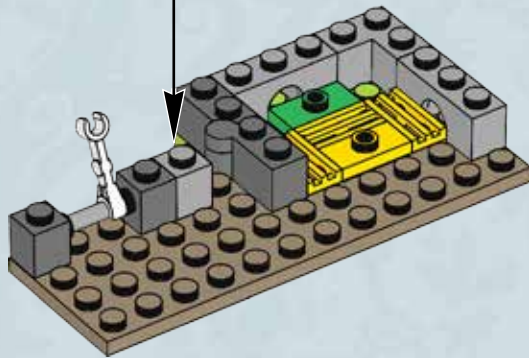

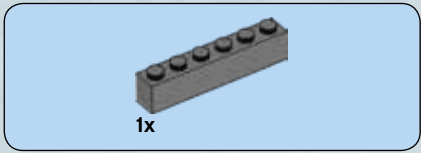

6

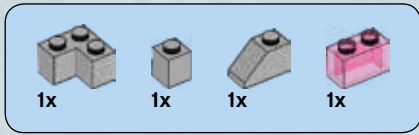
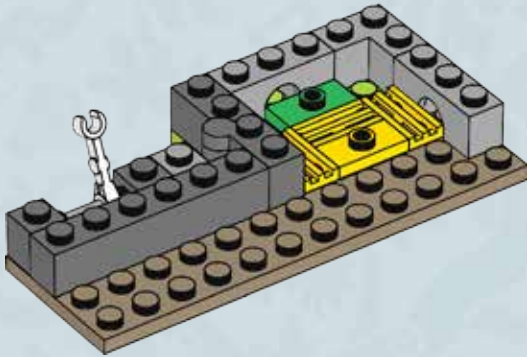

7

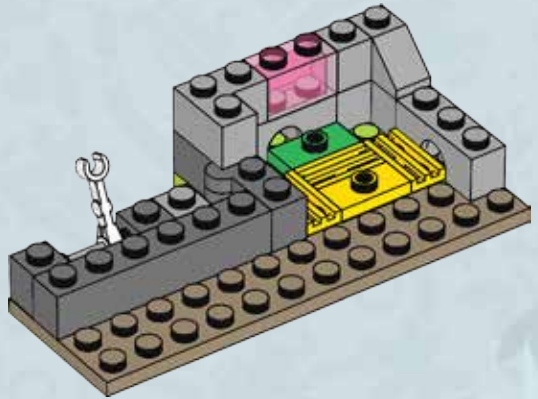



8

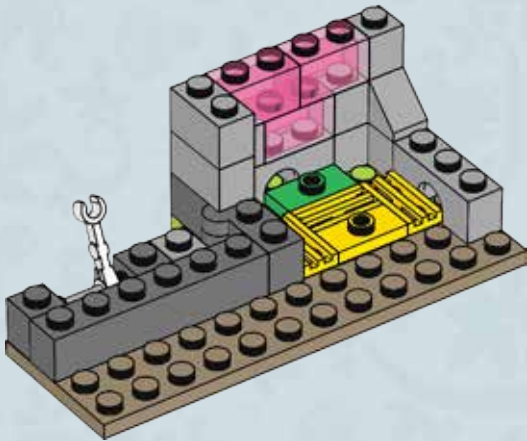

9

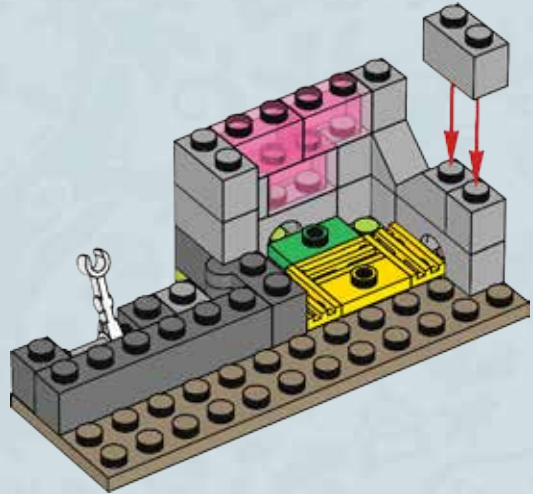



10

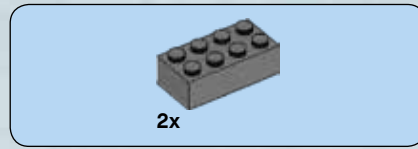
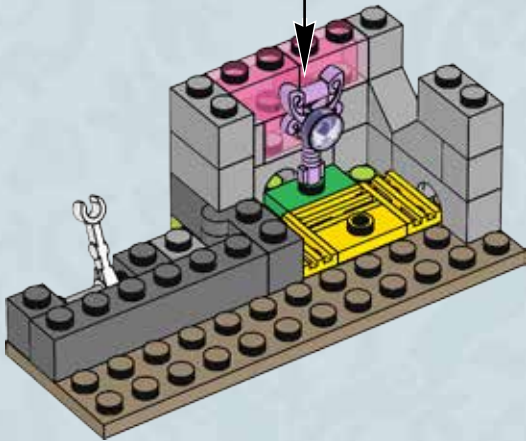
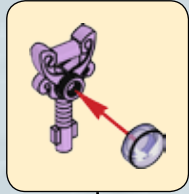

11

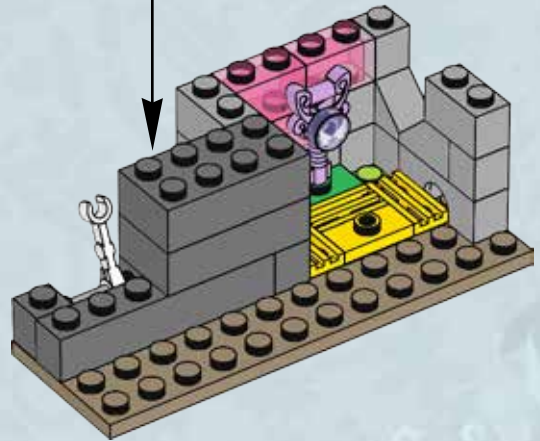
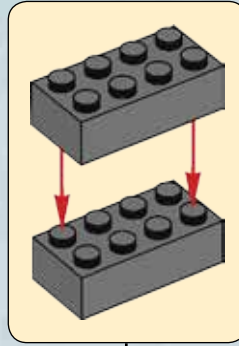

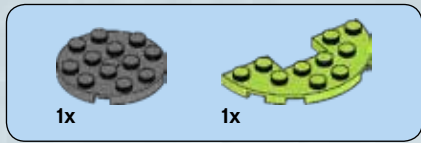

12

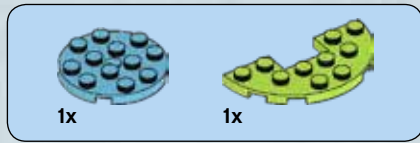
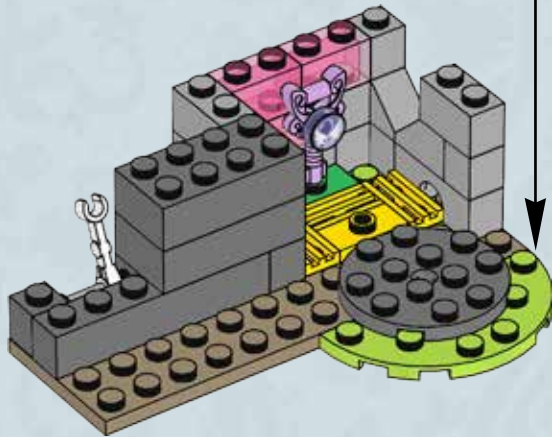

13

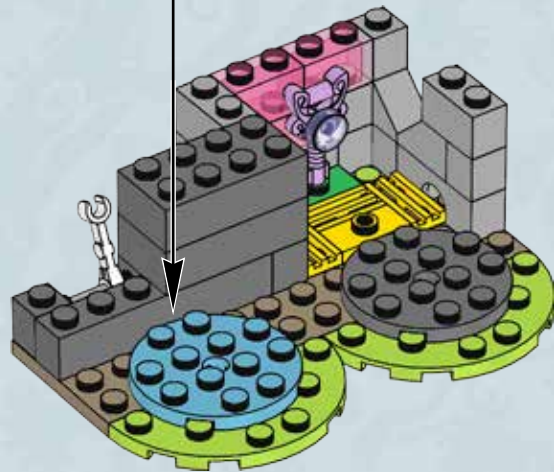
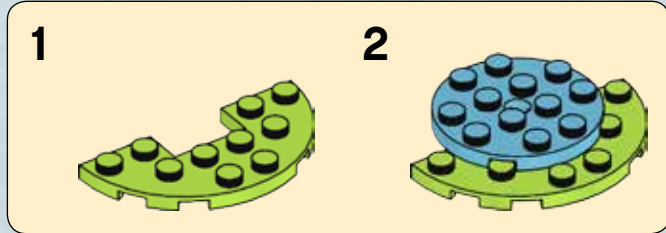

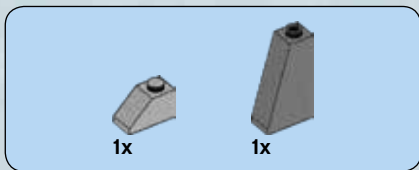

14

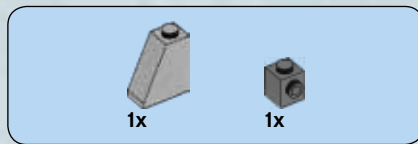
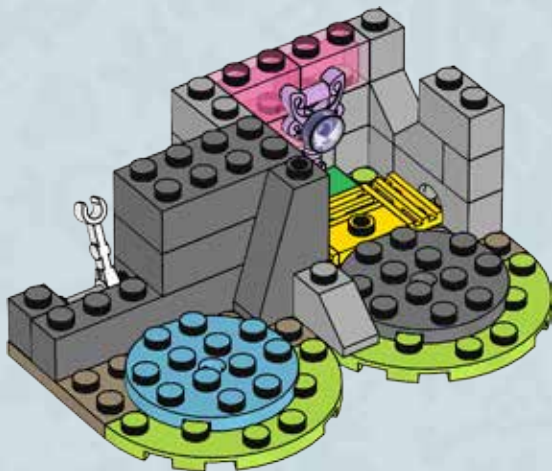

15

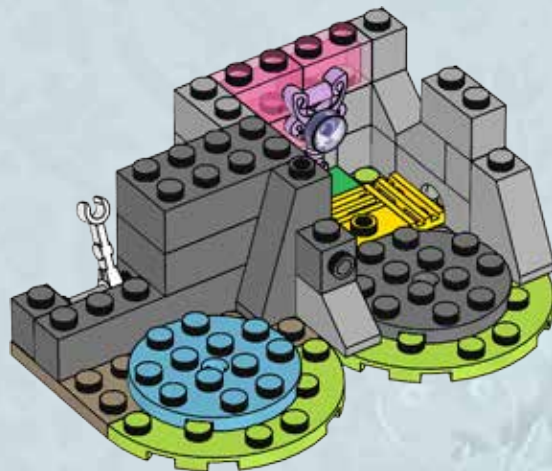



16

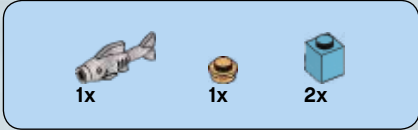
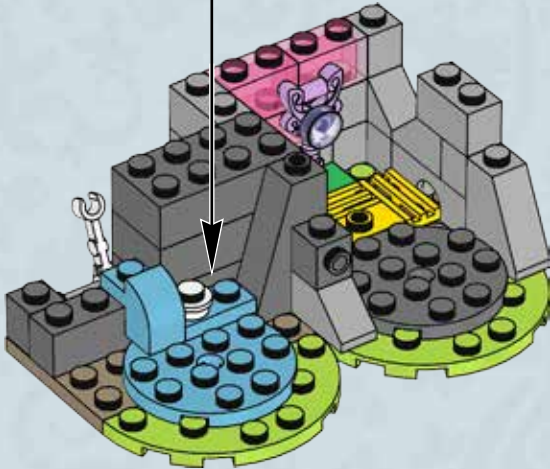
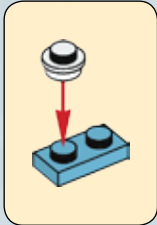

17

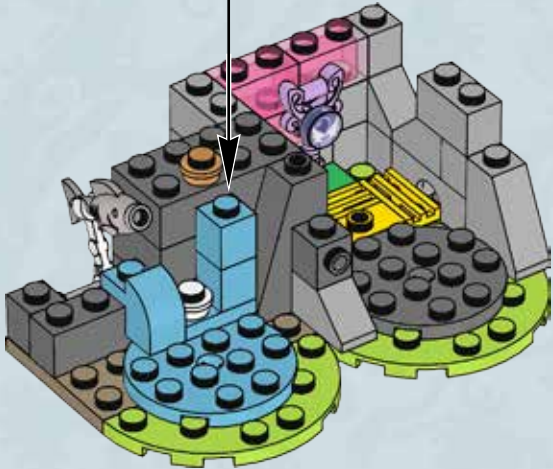
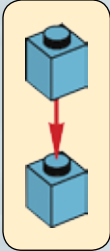



1x

18

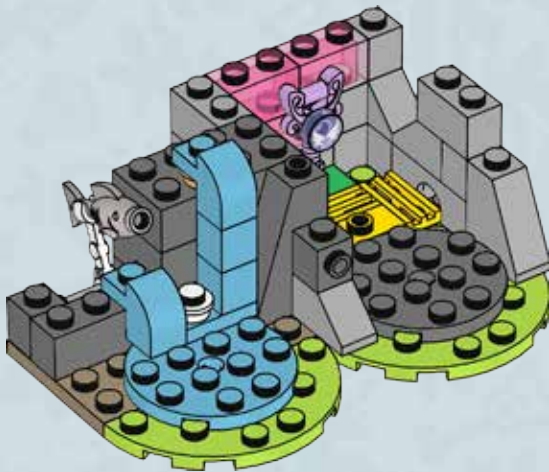

1x



1x

19

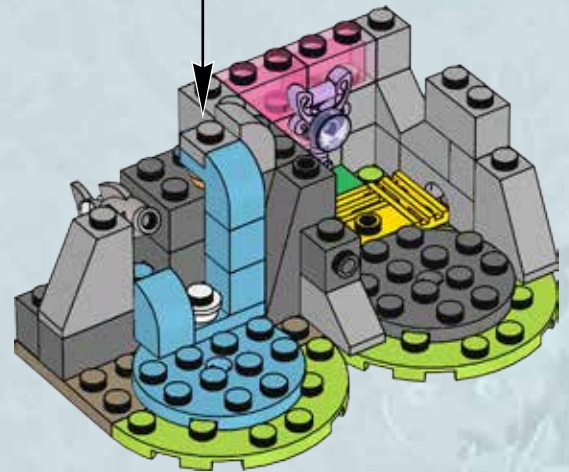
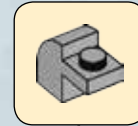



1x

20

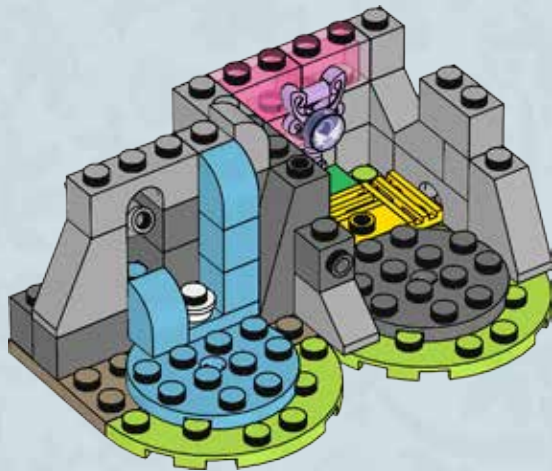

1x



1x

21

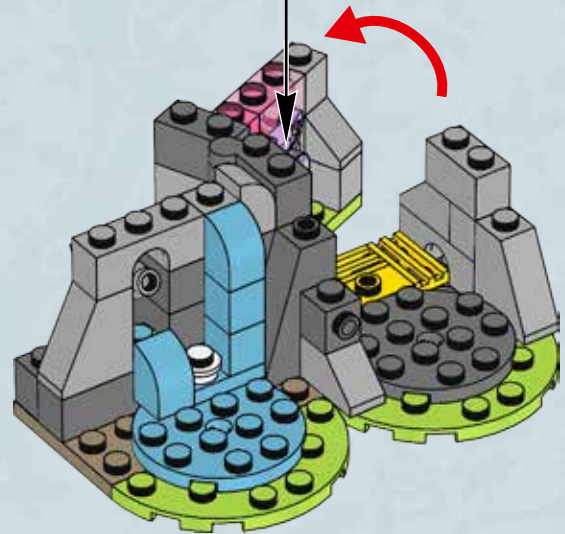
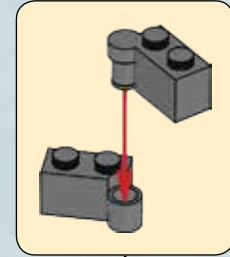

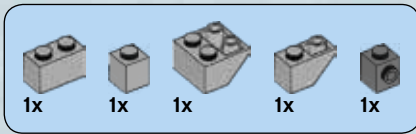

22

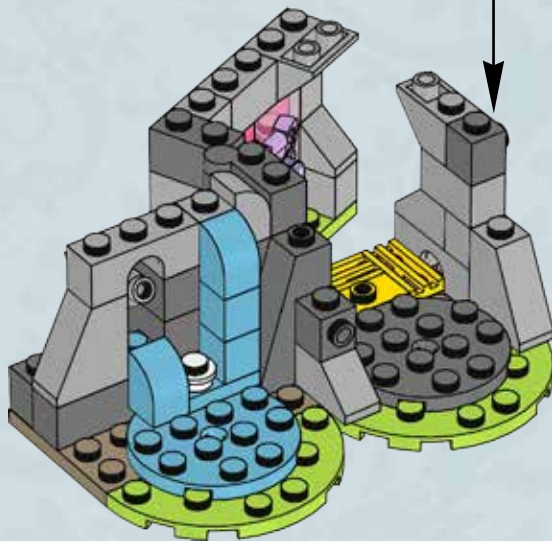

23

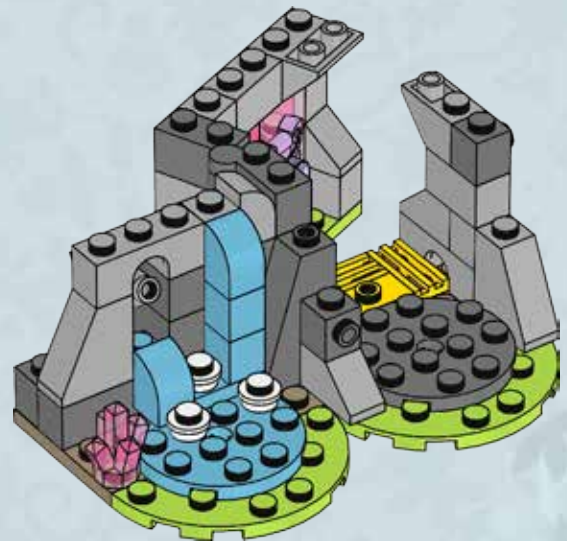

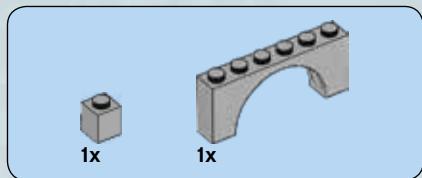

24

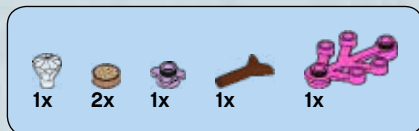
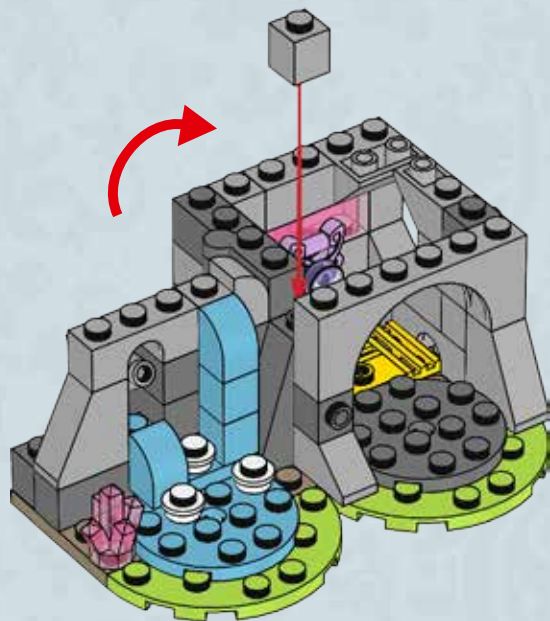

25





3x

26



27

1



2



3



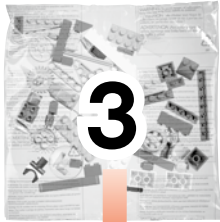

2x

28

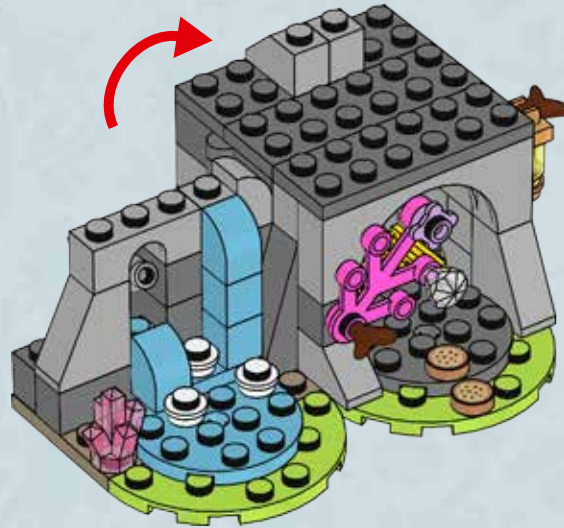

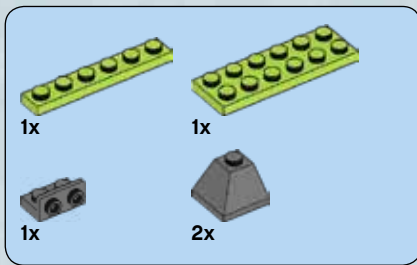

29



30



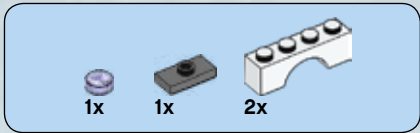

31

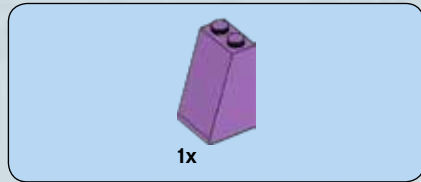
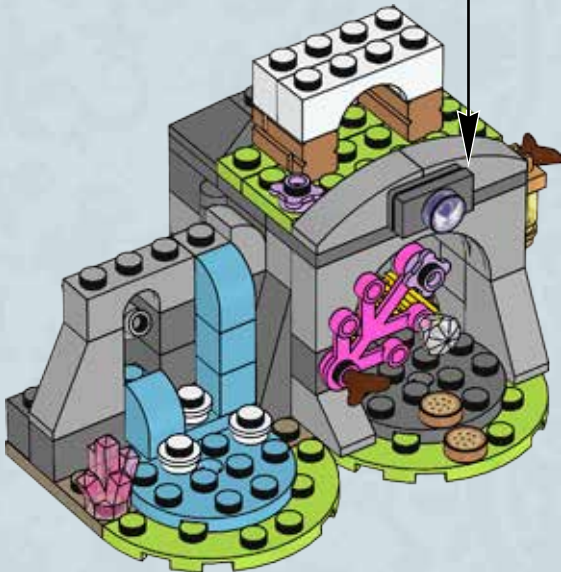
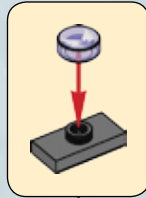

32

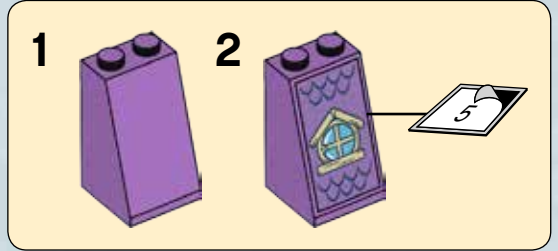

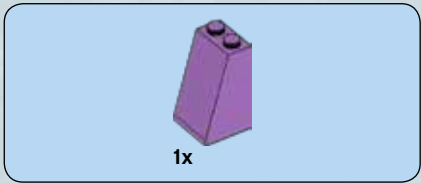

33

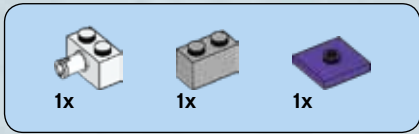
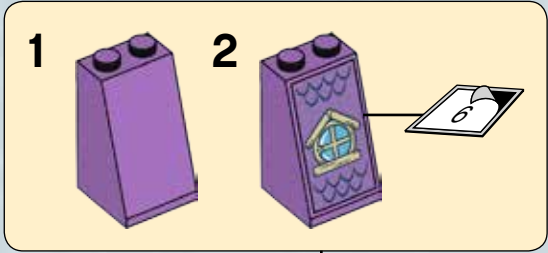

34





35

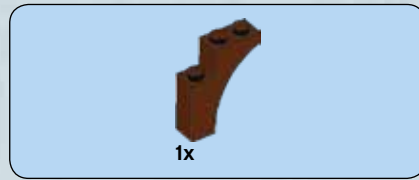

36

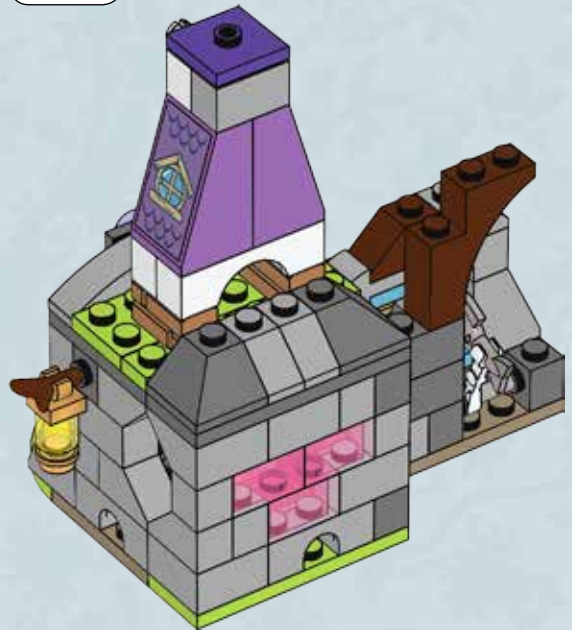
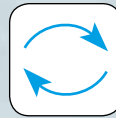



1x

37

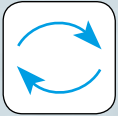

1x



1x

38





1x



1x

39

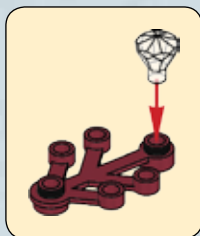

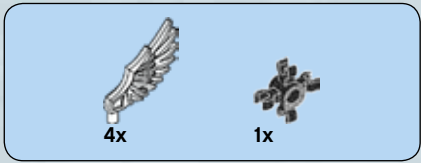

40

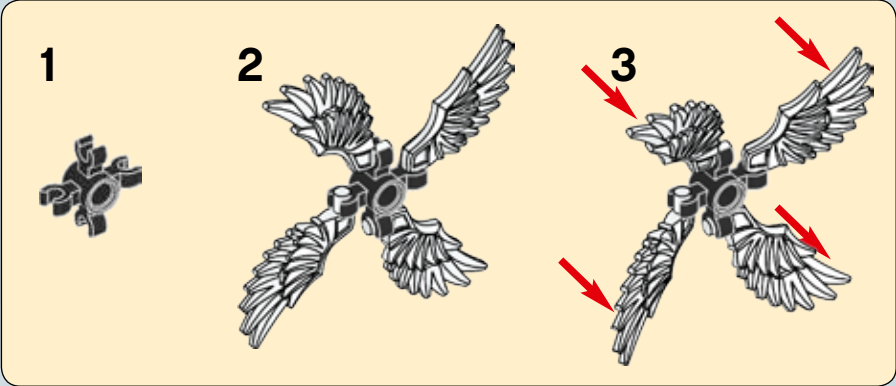

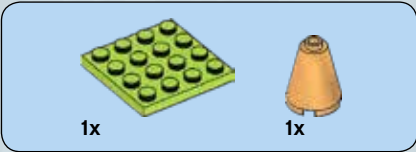

1

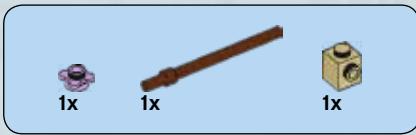

2

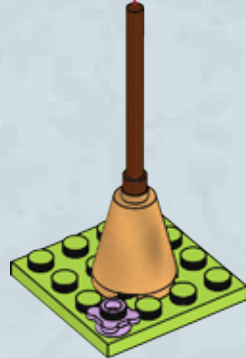
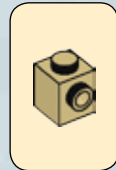



1x



1x



1x

3

1



2



1x



1x



1x

4

1



2





5

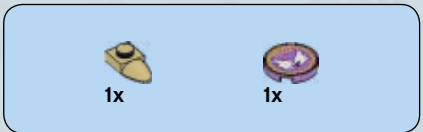
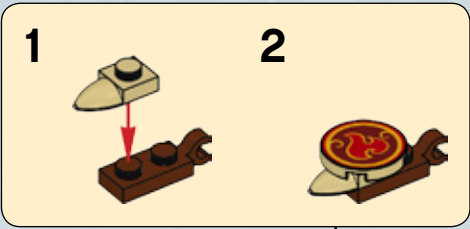

6







ELVES





 [LEGO.com/elves](https://www.LEGO.com/elves)

Azari



ELVES



Aira



Emily Jones



Naida



Farran



ELVES





ELVES

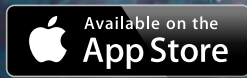

Apple, the Apple logo, iPad and iPhone are trademarks of Apple Inc. Google Play is a trademark of Google Inc.



ELVES



41077



41078



41075



41073



41074



41076



41072



41071

 LEGO.com/elves



Friends



41105



LEGO.com/popstar



CREATOR



31035



31036



31038



3 IN 1

LEGO.com/creator



1x
4160228



2x
609101



2x
6034044



2x
365901



2x
6035405



2x
302401



2x
362301



1x
4560178



1x
303201



2x
4613256



2x
4598527



4x
4556152



1x
4527945

74



3x
614101



1x
4161326



1x
4160857



1x
6106066



1x
6056353



4x
6018302



1x
6115935



1x
6115944



2x
4495927



1x
4579260



1x
6104425



1x
6104406



4x
4224793



2x
6013938



2x
4142865



4x
4514553



2x
4201615



4x
4550348



2x
366524



1x
303924



1x
374724



1x
6092583



3x
241224



2x
4560181



4x
4621603



1x
4141628



2x
4503425



4x
302226



2x
242026



1x
4569733



2x
6000650



6x
4556158



3x
281726



2x
4515368



1x
4550190



1x
6052369



1x
4140430



2x
4142236



2x
4121715



4x
6089119



1x
6092586



3x
4278412



2x
4248937



1x
4646864



3x
3006844



3x
6096995



1x
6099532



1x
4529160



1x
4504850



2x
4621548



1x
6104413



2x
6109765



1x
6107429



2x
6066120



2x
6115827



5x
6065505



1x
6024916



1x
6103036



1x
6117859



2x
4211199



1x
6069984



1x
6055086



3x
6008297



1x
6081990



2x
6078605



6x
4211389



4x
4211388



2x
4211349



2x
4515374



1x
4211437



6x
4211614



1x
4211436



1x
4211519



3x
4645397



2x
4251163



1x
6106189

1x 4211414
 1x 4211396
 1x 6093527
 2x 4211483
 4x 4211807
 2x 4211085
 1x 4211100
 4x 4558955
 1x 4221745
 2x 4210646
 1x 6092572
 3x 4211002
 1x 6000606
 4x 6055313

1x 4528323
 2x 6011461
 2x 4210795
 1x 6093480
 1x 4659770
 2x 6057988
 1x 6116753
 2x 6109754
 1x 6102378
 1x 6102366
 4x 6109757
 1x 6092672

1x 6071259
 6x 4523159
 2x 6069990
 2x 6097514
 4x 6114676
 6x 6109756
 2x 6109755
 2x 4656783
 2x 6055384
 1x 6102406
 1x 6102373
 1x 4611885
 2x 4619652
 2x 4655246

1x 6097419
 1x 6102828
 1x 6116243
 1x 6104410
 2x 6022007
 4x 4625616
 2x 4619514
 7x 4619512
 4x 4619517
 5x 4619524
 6x 4619516
 2x 4625022
 2x 6104415

1x 6056227
 1x 6056226
 2x 6097053
 2x 6037657
 3x 6074906
 1x 6103003
 1x 6097248
 2x 6114675
 2x 6114674

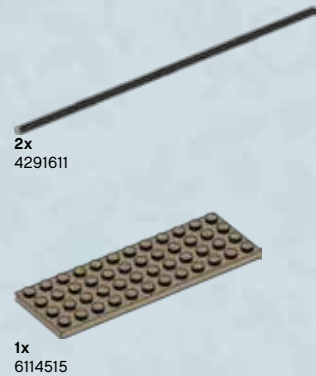

2x 4291611
 1x 6114515



Customer Service
 Kundenservice
 Service Consommateurs
 Servicio Al Consumidor
 LEGO.com/service or dial



: 00800 5346 5555
 : 1-800-422-5346

WIN

GO TO WWW.LEGO.COM/PRODUCTFEEDBACK AND
GIVE US YOUR SHORT **FEEDBACK** ABOUT THIS
LEGO® SET FOR A CHANCE TO WIN
A COOL LEGO PRIZE.



LEGO.com/productfeedback

GEWINNE



Erzähle uns auf
www.LEGO.com/productfeedback

*etwas über die Erfahrungen, die du mit
diesem LEGO® Set gemacht hast, und
sichere dir die Chance auf einen coolen
LEGO Preis!*

GAGNE



Rends-toi sur
www.LEGO.com/productfeedback

*et donne-nous quelques commentaires
sur ce produit LEGO® pour avoir une
chance de gagner un prix LEGO !*

GANAN



Visita
www.LEGO.com/productfeedback

*y envíanos tu opinión acerca de este set
LEGO®. ¡Participarás en el sorteo de un
premio LEGO!*

获取奖品



登录
www.LEGO.com/productfeedback

*给出关于此乐高®套装的简短反馈，
就有机会获得炫酷乐高高奖品*