



JUNIORS

10667







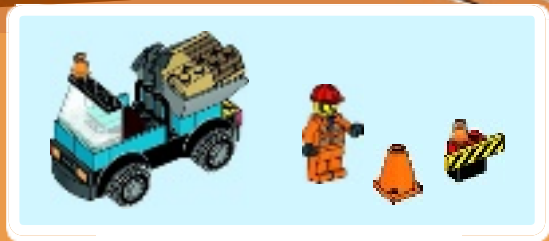

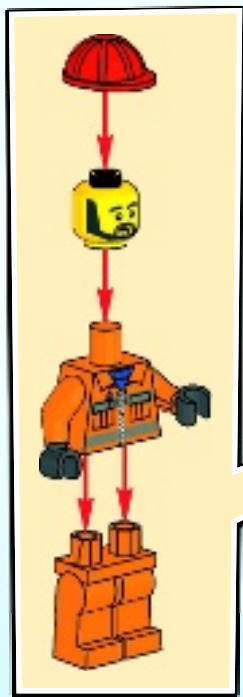

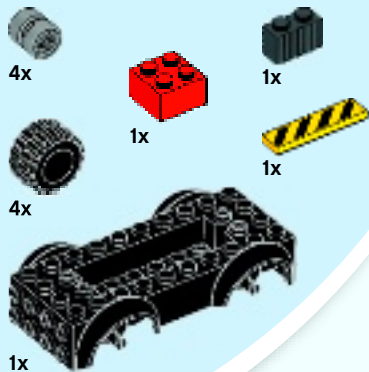

1

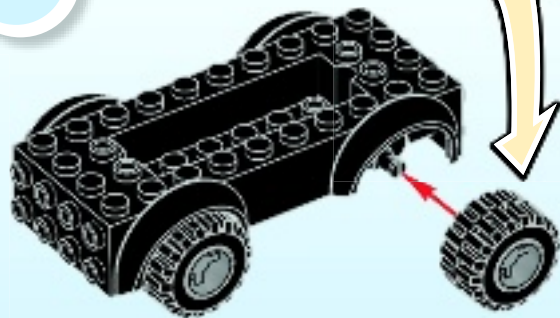
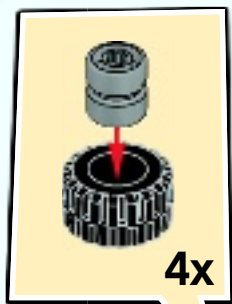

2



3

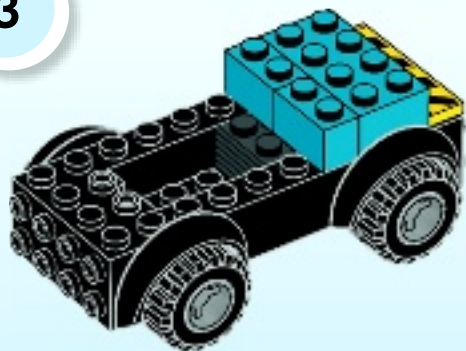

4

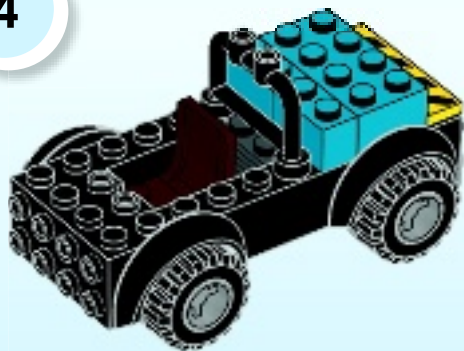
A minifigure with brown hair and a green shirt, holding a magnifying glass over a circular area.

1x

1x

2x

1x



2x



2x



1x



1x



1x



5

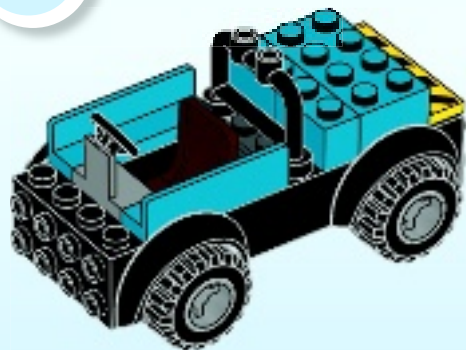

6

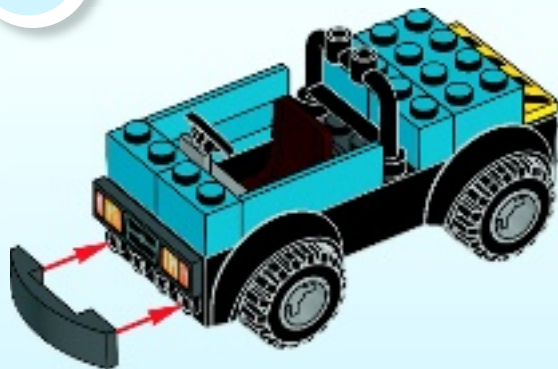

7

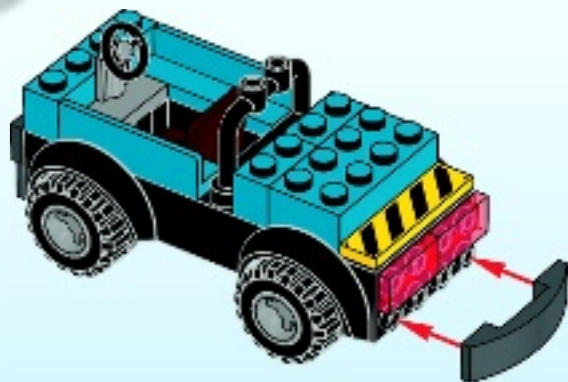

8

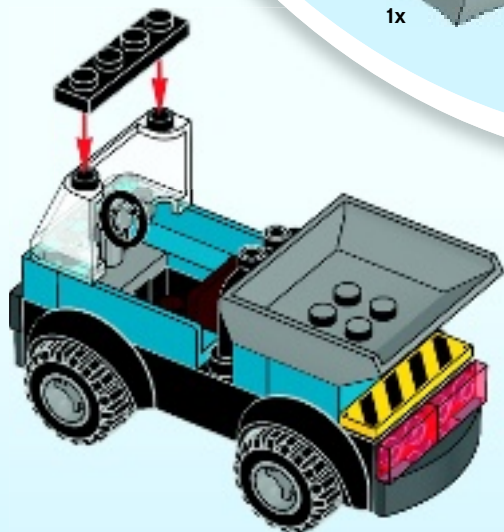

2x

1x

1x

1x

1x

1x



2x



2x



1x



2x



1x



9

1



2

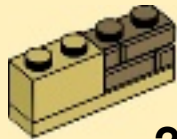

2x



10

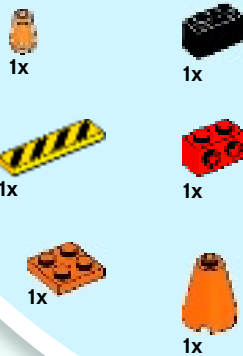
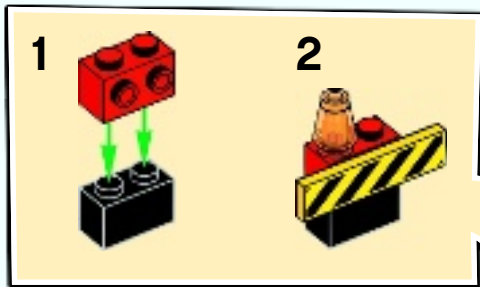

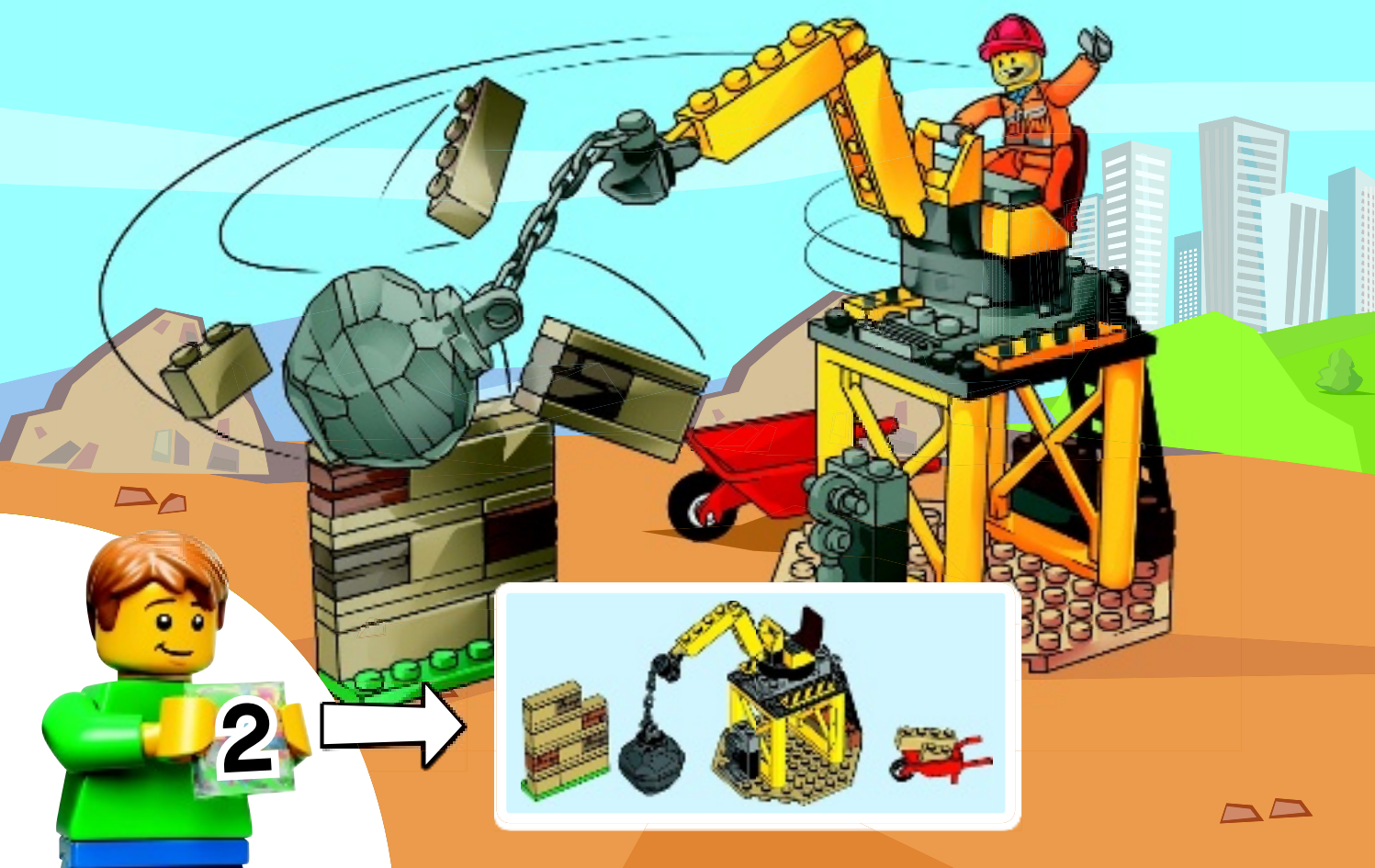

2





1x



1x



1x

1

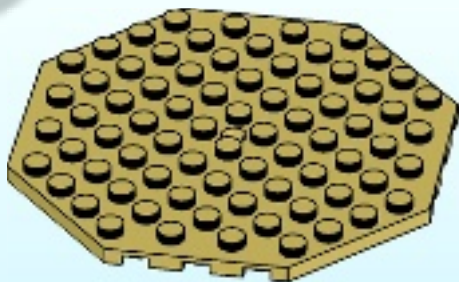

2





1x



1x



1x



1x

3

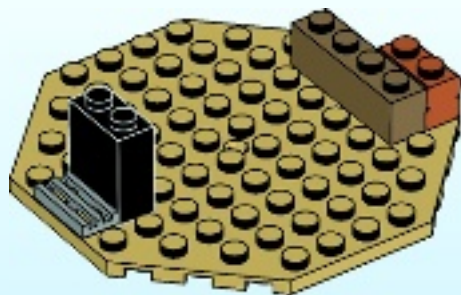

4

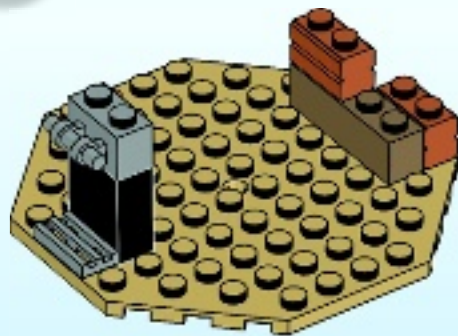

5

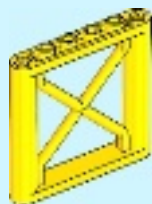
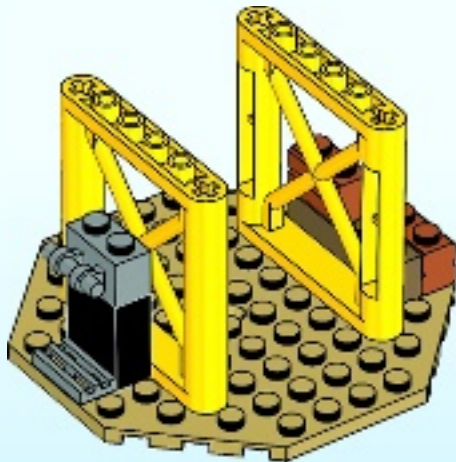

2x

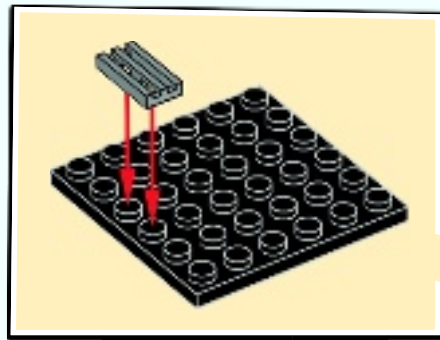

6

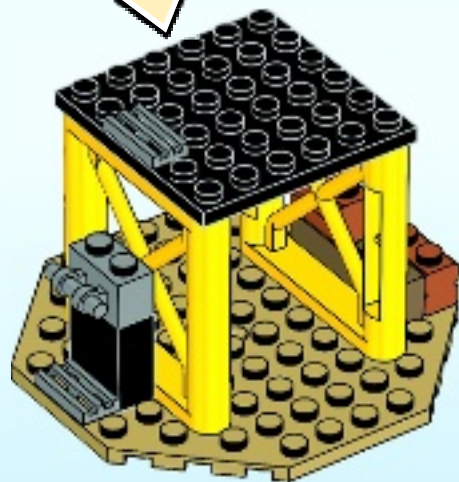



2x



1x

7

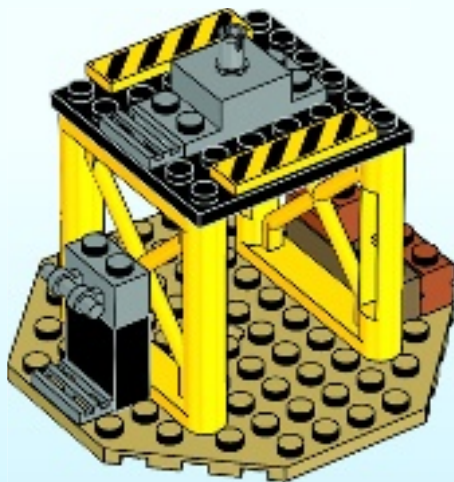

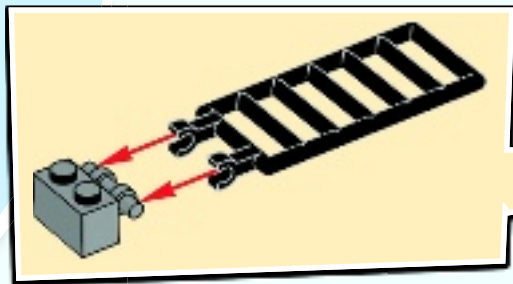

8

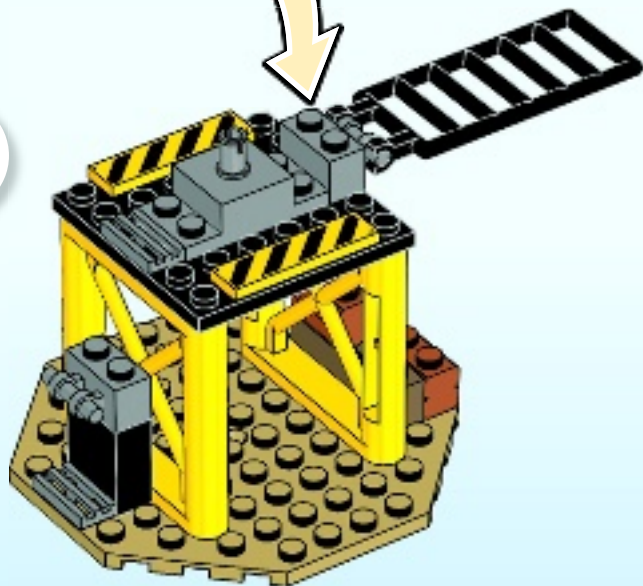



2x



1x



1x



1x

1



2



3



4





5



6



9



10

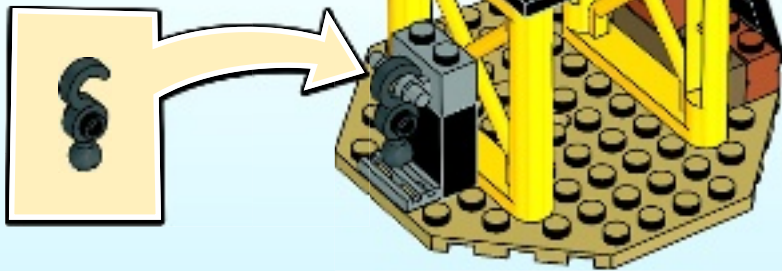

1x



2x

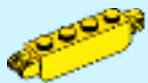

1x



1

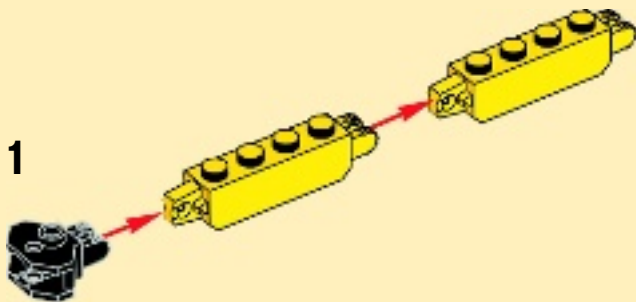

2

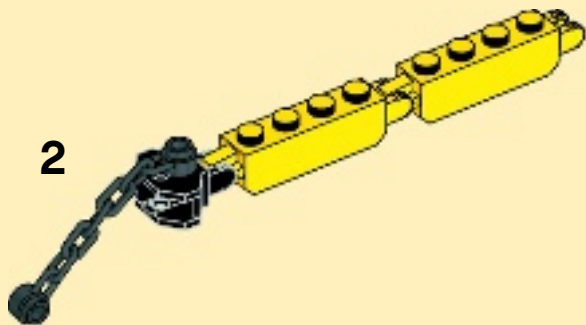

11

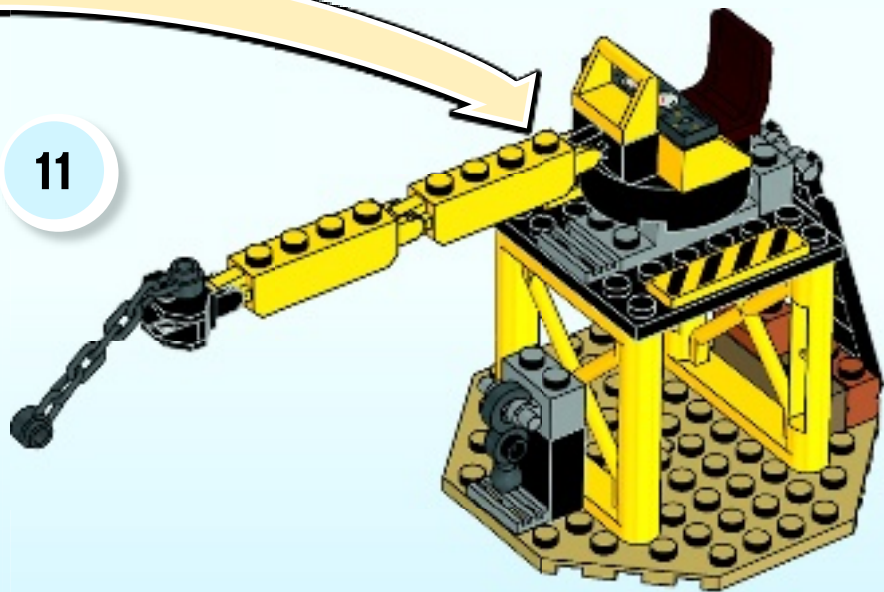



1x



1x



1x

12

1



2

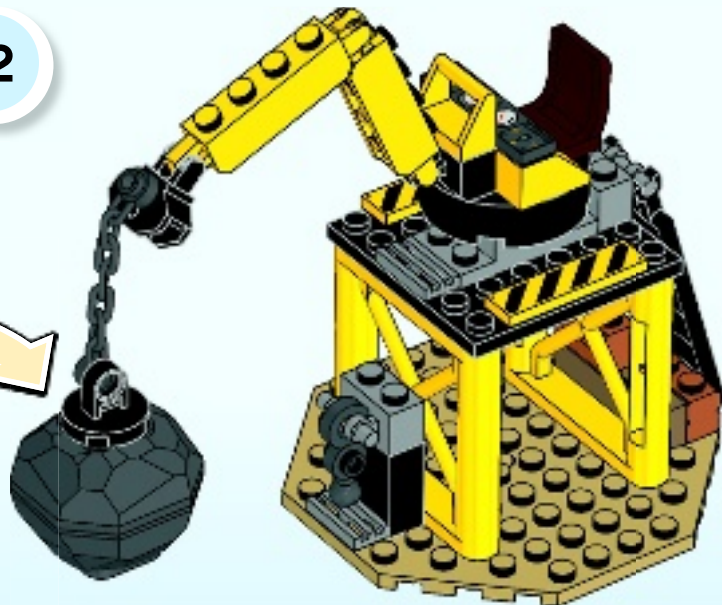

1



2



3



1x

1x

1x



1x



1x

1x



1x



1x



1x

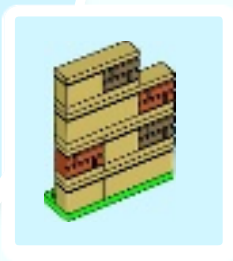

1

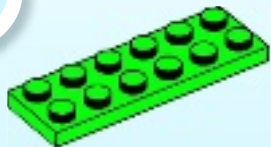

2

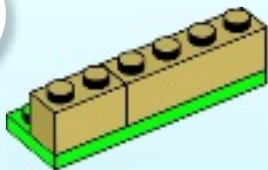

3

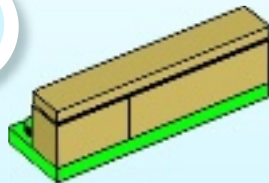

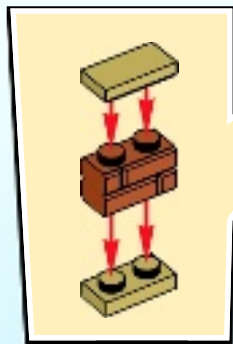
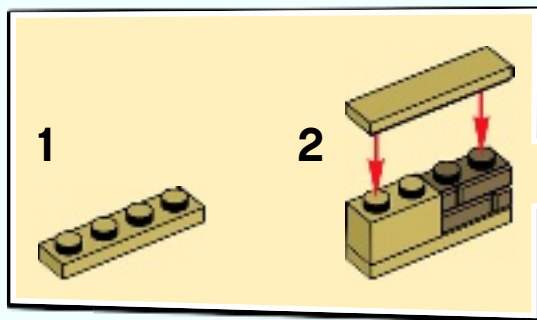

4

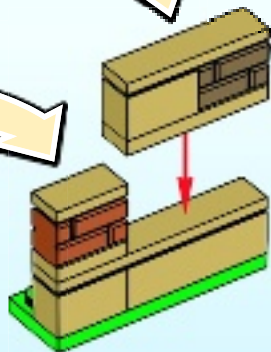

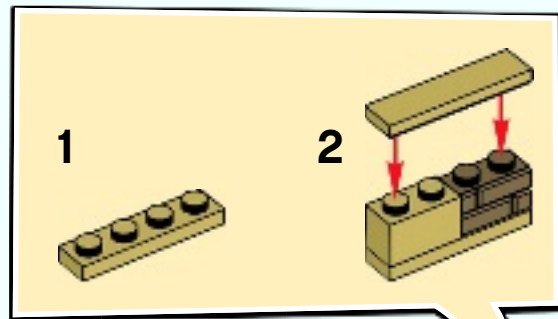
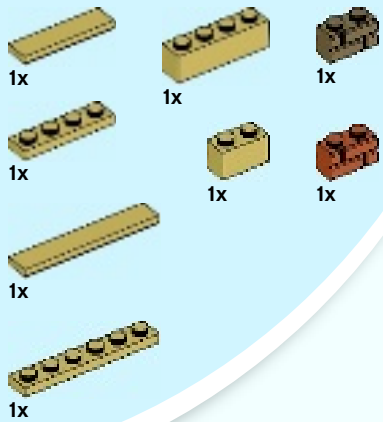

5

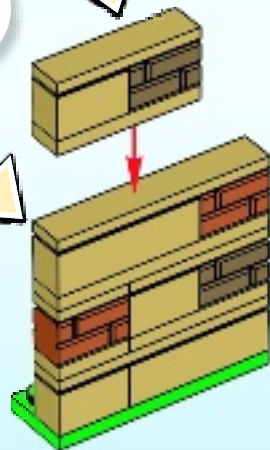
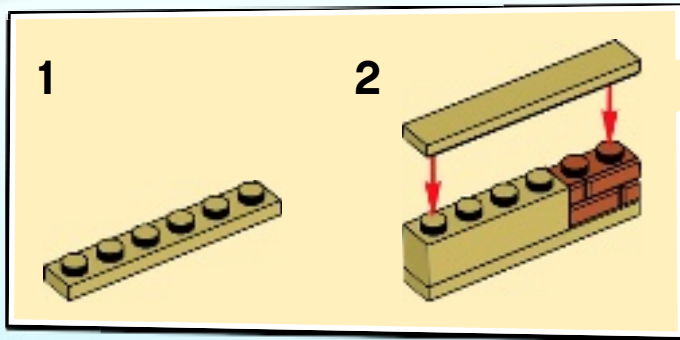

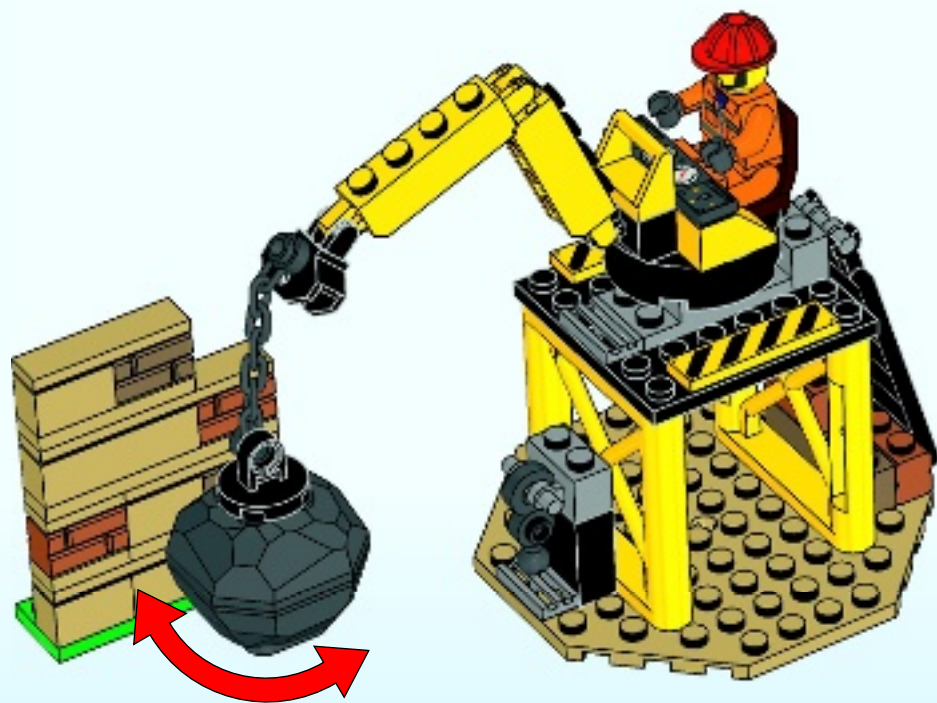



JUNIORS



10668



10667



10674



10673



Ready for more? build and play

- Bereit für mehr? Bauen und Spielen
- Encore plus de jeu ? construis et joue
- ¿Estás preparado? ¡Más construcción y más juegos!
- Estás pronto para mais? constrói e brinca
- Készen állsz MÉG TÖBB építésre és játékra?



LEGO CITY
5-12

LEGO JUNIORS
4-7



THE CITY WITH ENDLESS POSSIBILITIES...

LEGO.COM/CITY



WIN!

Go to LEGO.com/productfeedback to fill out a survey for a chance to win a cool LEGO® Product.

No purchase necessary.
Open to all residents where not prohibited.



LEGO.com/productfeedback

GEWINNE!

Nimm an der Umfrage auf LEGO.com/productfeedback teil und hab die Chance ein cooles LEGO® Produkt zu gewinnen!

Die Teilnahme am Gewinnspiel führt zu keinerlei Kaufverpflichtungen. Teilnahme in allen nicht ausgeschlossenen Ländern möglich.



6072698

WIN!

Ga naar LEGO.com/productfeedback, vul een enquêteformulier in en maak kans op een cool LEGO® product.

Geen aankoopverplichting.
Iedereen mag deelnemen, uitgezonderd ingezetenden van landen waar een enquêteverbod geldt.

GAGNE!

Visite LEGO.com/productfeedback pour répondre à un questionnaire et avoir une chance de gagner un produit LEGO® très cool!

Aucune obligation d'achat.
Ouvert à tous les résidents des pays autorisés.

当てよう!

LEGO.com/productfeedback にアクセスして、アンケートにご記入ください。当選者にはレゴ®製品を差し上げます。

お買い上げの必要はありません。
禁止されていない限り、すべての皆様にご利用いただけます。



JUNIORS

10667



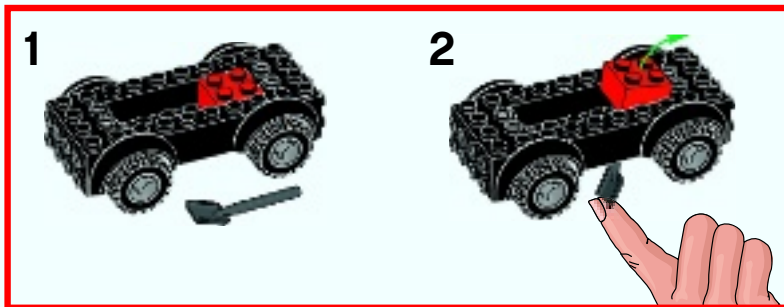

LEGO.com/brickseparator

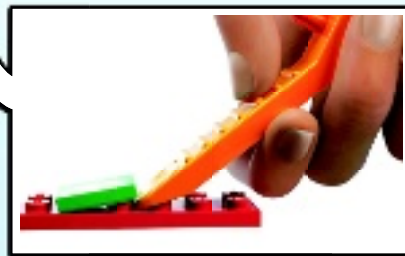
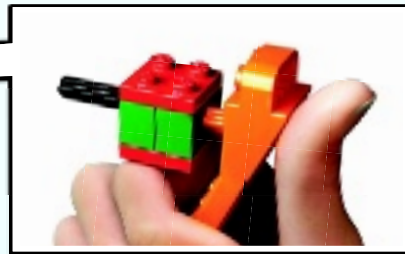



Build & Rebuild



+



+





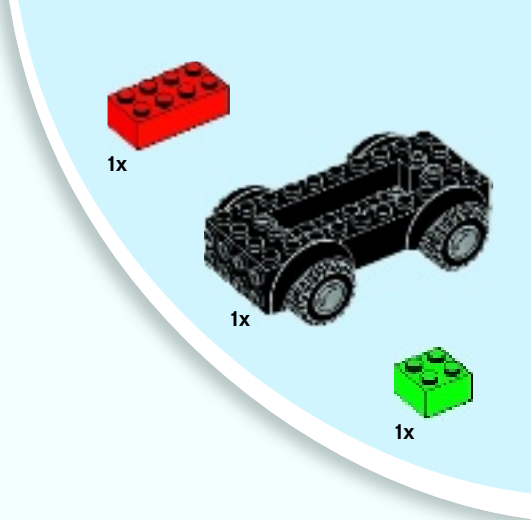

1

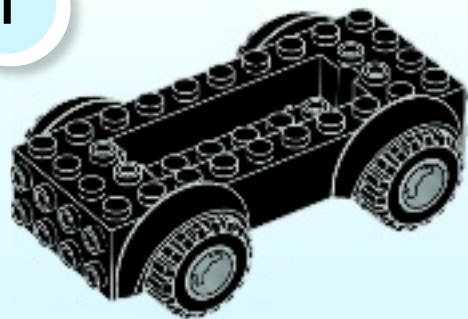

2





3

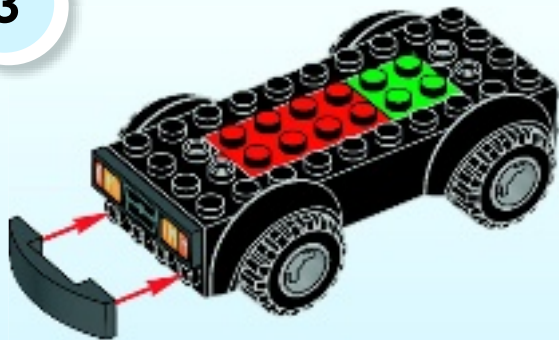

4

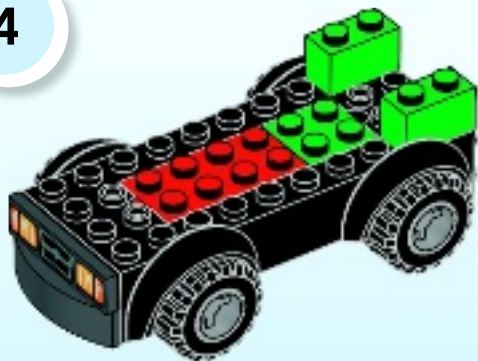

5

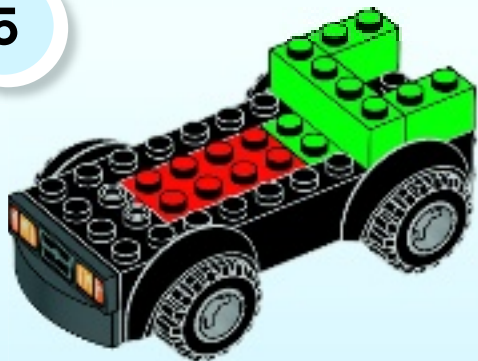

2x



1x



6

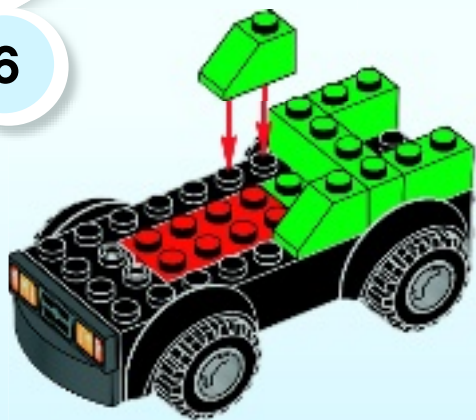

7

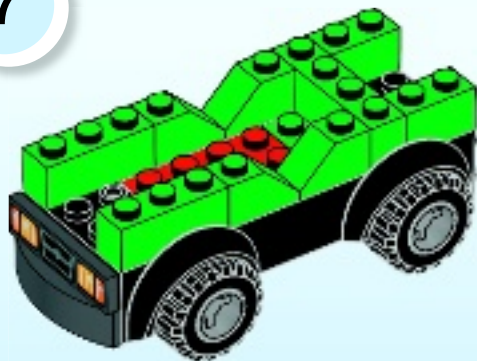

8

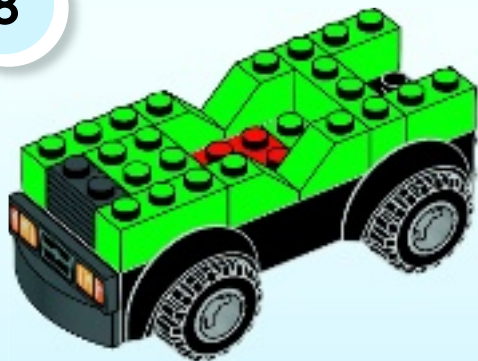

9

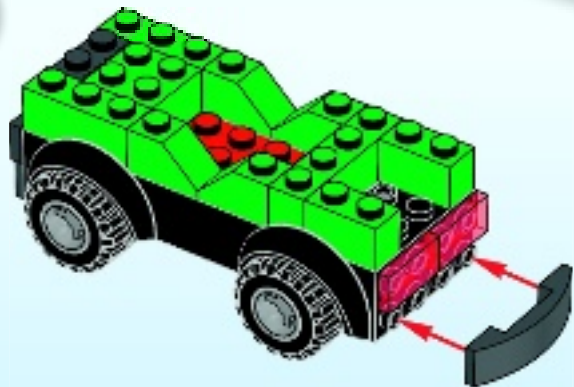

1x



1x



2x



1x



1x



1x



1x



1x



1x

10

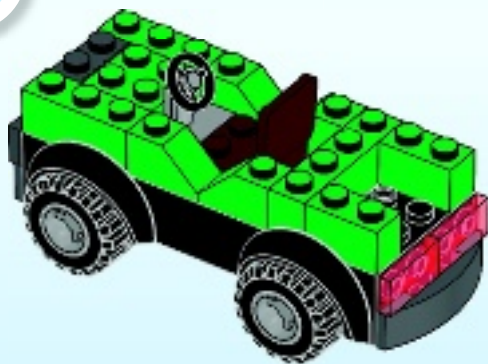

11

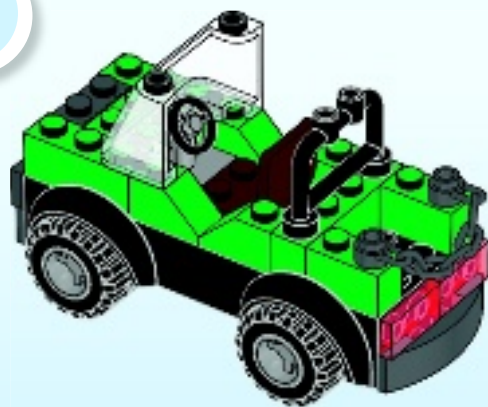

12



13



1x



1x



1x



1x



1x



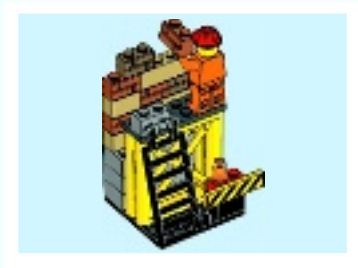

3x



3x



1x

1



2

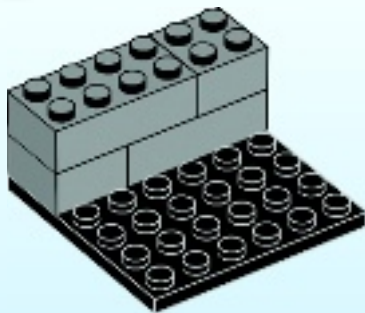

3





1x



1x



2x

4



5

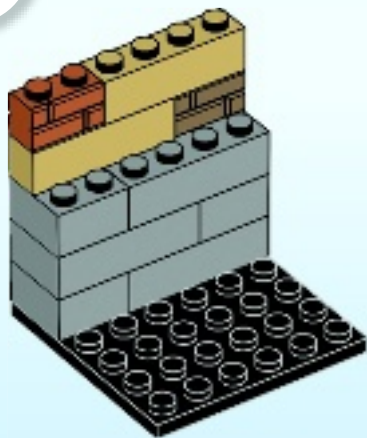

6

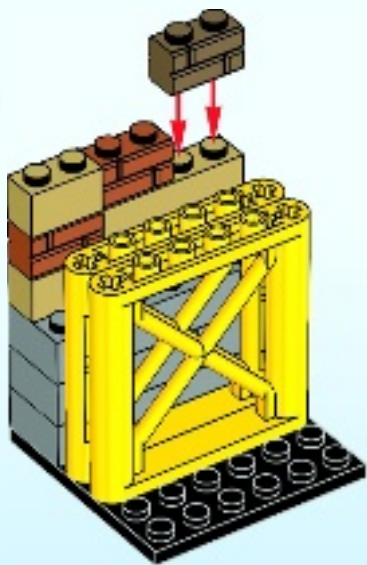

7

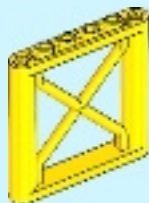
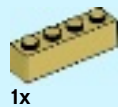
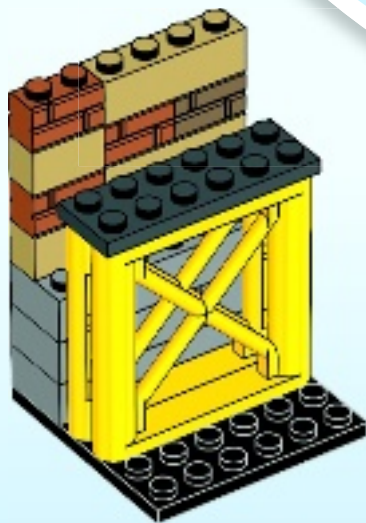



1x



1x



1x

8

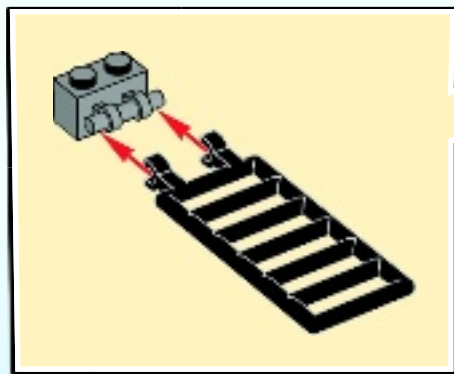

9





1x
4296997



1x
383321



2x
4121934



1x
6019155



2x
300421



2x
300321



3x
300121

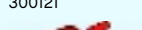

1x
4646527



6x
4109995



3x
4113916



1x
4114026



1x
4113917



4x
4113233



2x
4550324



1x
4124067



2x
4157277



1x
6037610



1x
4144567



1x
4163904



2x
4167106



1x
602026



1x
371026



1x
395826



1x
6025012



1x
300426



1x
4618852



1x
6010831



1x
408326



1x
4516843



4x
4568644



1x
4558957



1x
6031982



1x
4120158



2x
4121739



2x
4153825



2x
4153827



1x
6022148



1x
4159007



1x
4654448



2x
4189801



4x
4121969



2x
4107736



2x
300328



2x
4109679



2x
4112838



2x
4106356



1x
379528



1x
4226995



3x
4211387



3x
4211385



2x
4211580



1x
4211666



2x
4211350



1x
4211452



1x
4520296



4x
4211764



4x
4656783



6x
6004943



3x
4655172



2x
6021547



2x
4211206



1x
382340



2x
4121965



2x
300424



2x
300324



2x
300124



2x
4218728



4x
4119091



2x
6057479



1x
4262093



1x
243224



2x
4164022



2x
4220632



2x
4165967



4x
4646577



1x
6001822



2x
4567338



1x
4210636



2x
4648256



1x
6057518



1x
6020825



1x
4506778



1x
4506779



1x
4212529



1x
4211007



1x
4211006



1x
4600437



2x
4211002



Customer Service

Kundenservice

Service Consommateurs

Servicio Al Consumidor

LEGO.com/service or dial



: 00800 5346 5555

: 1-800-422-5346



LEGO.com/Juniors



App



Games



Find more building instructions
online



6072701

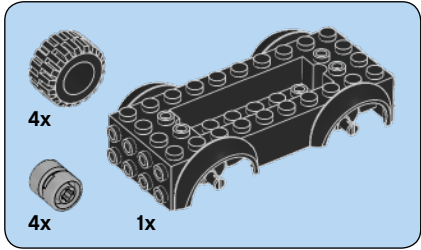
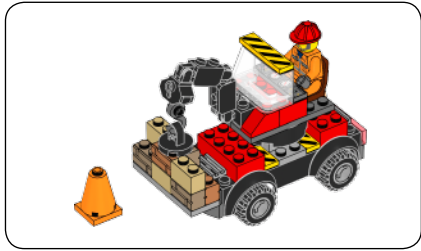

1

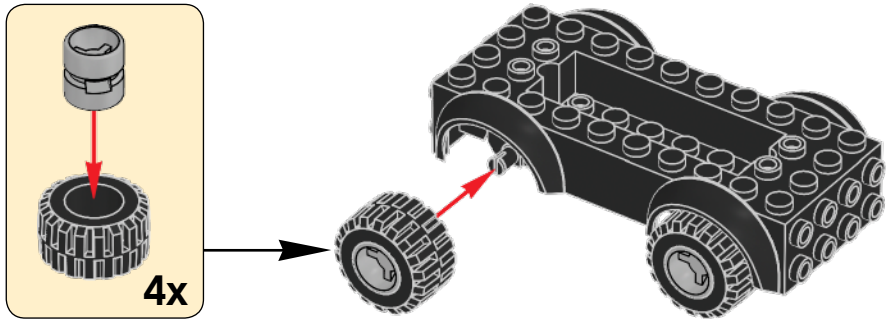

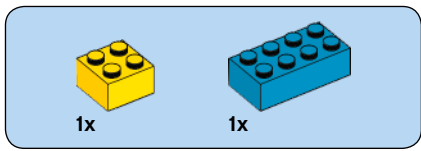

2

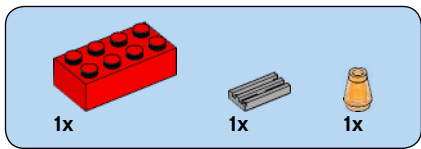
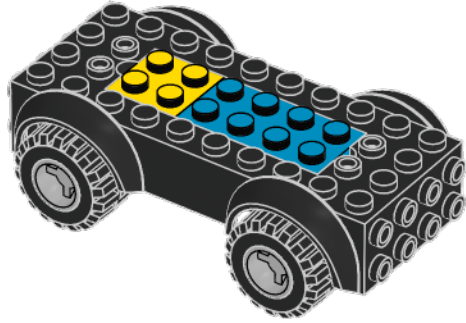

3

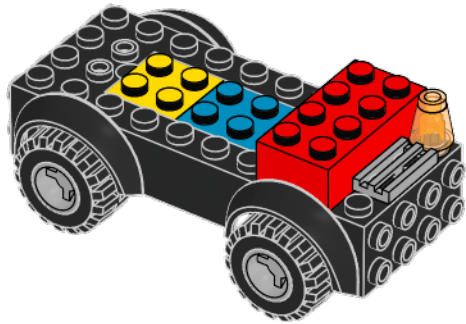

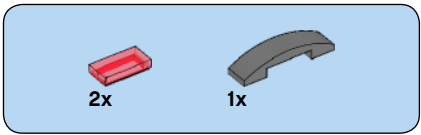

4

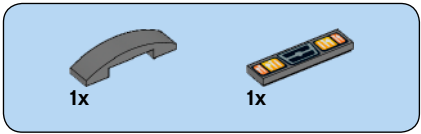
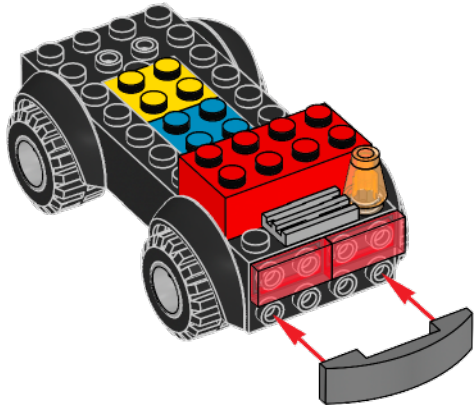

5

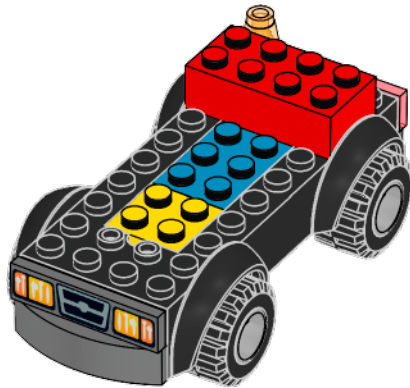

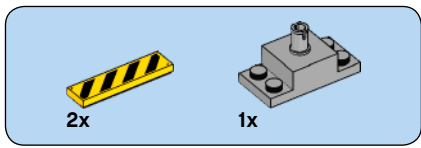

6

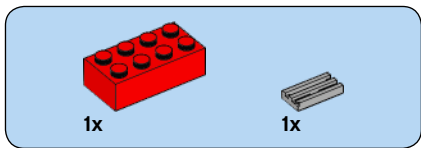
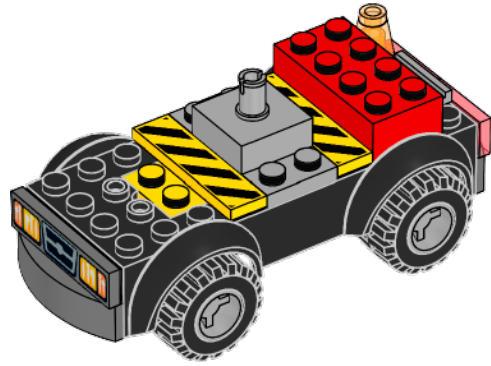

7

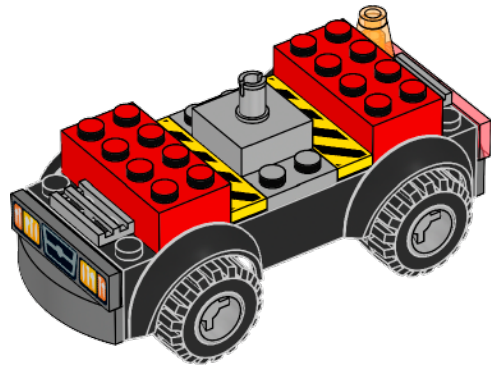

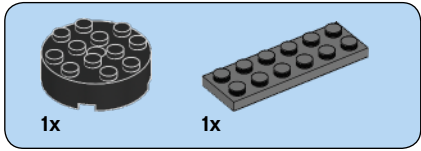

1

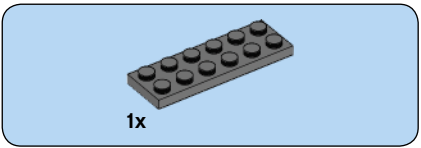
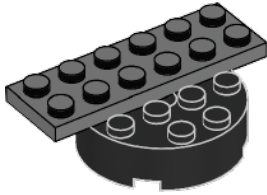

2

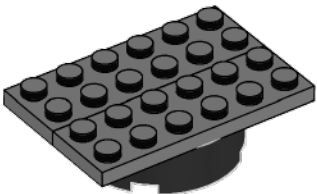

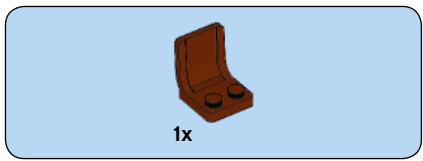

3

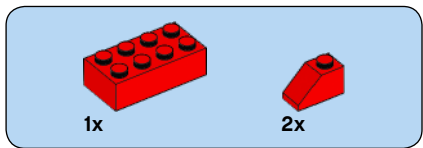
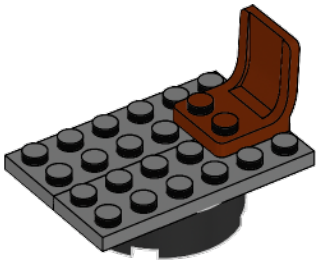

4

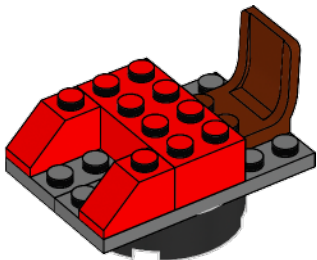

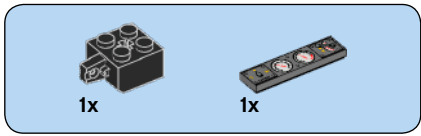

5

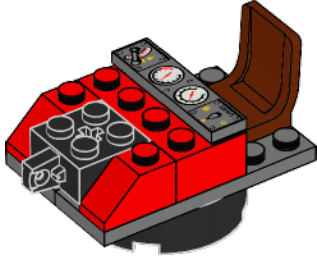

6

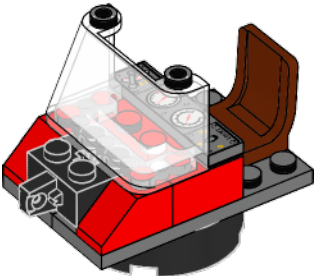

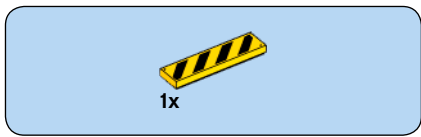

7

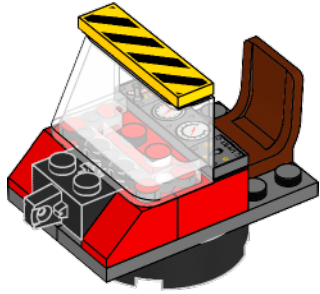

8

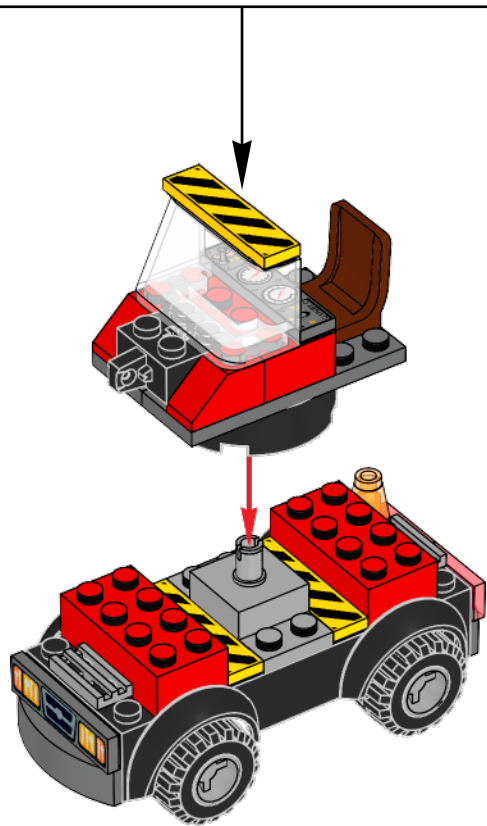

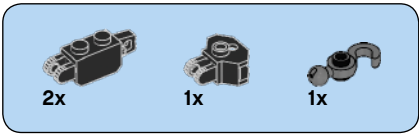

9

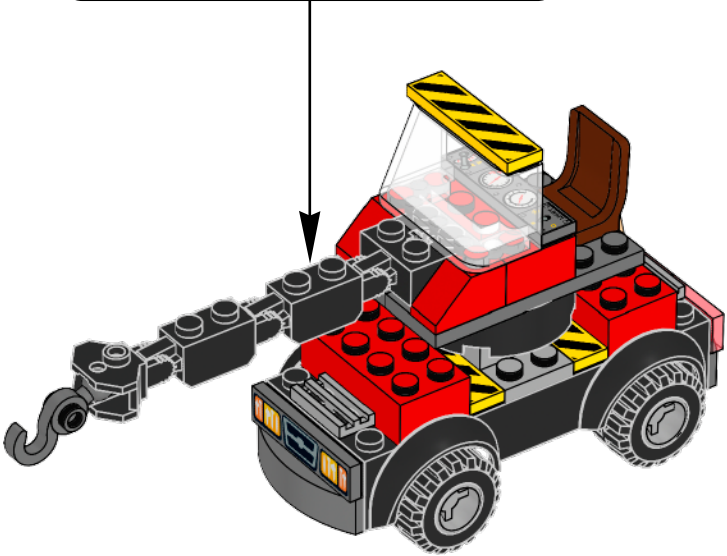
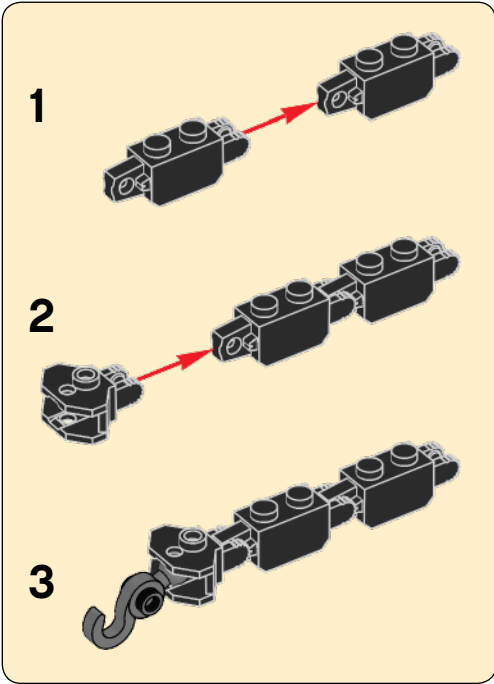

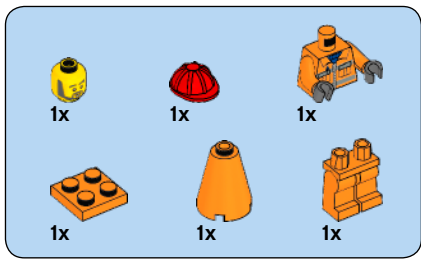

10

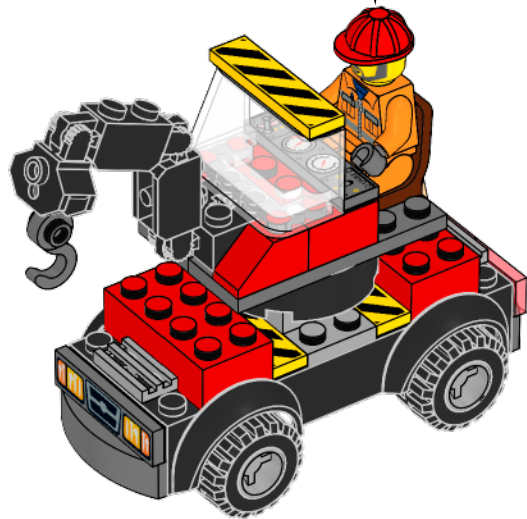
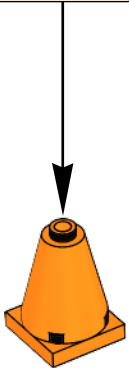
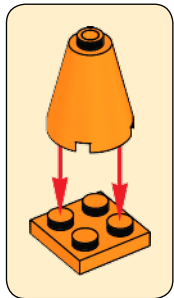
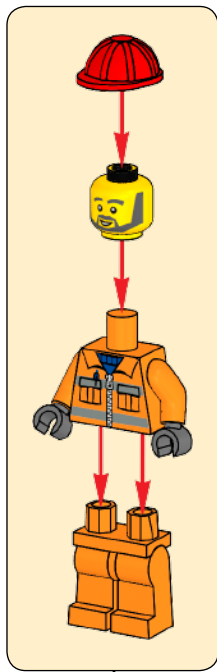

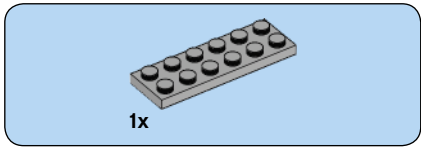
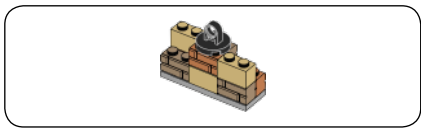

1

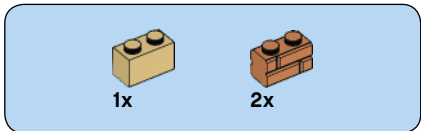
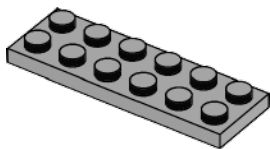

2

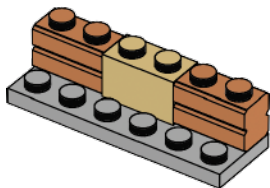

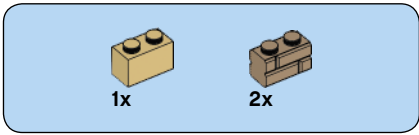

3

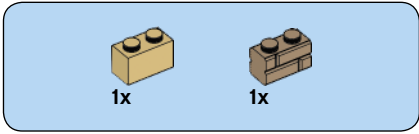
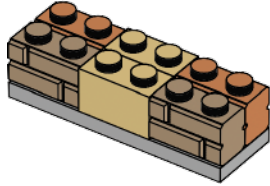

4

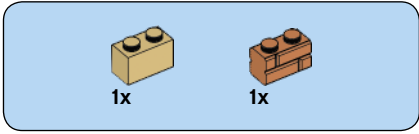
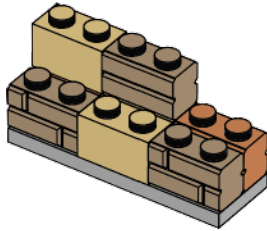

5

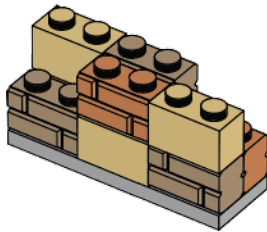



6

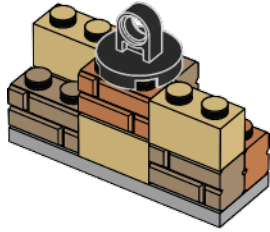

11

