



STAR WARS™

75130



 [LEGO.com](https://www.lego.com)

MICROFIGHTERS

SERIES 3

The Disney logo is shown in its classic script font, positioned in the bottom right corner of the image.

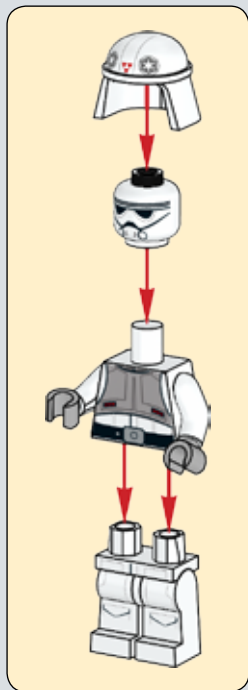



1x

1



1x

1x

1x

2

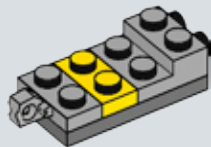

3



2x



2x

3



2x

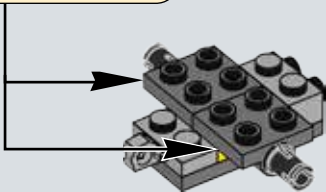

4

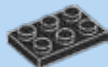

1x



1x

4

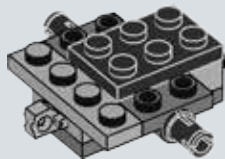

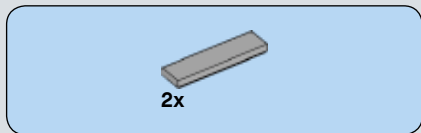

5

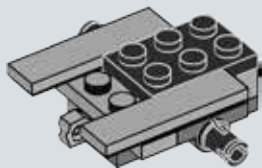

6

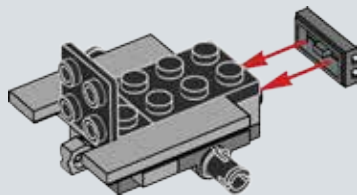



4x

7

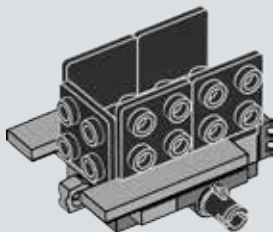

6



2x



1x

8

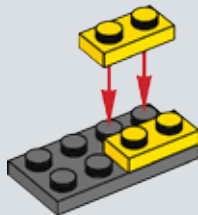



1x

9

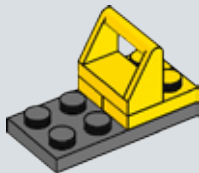

1x



1x

10

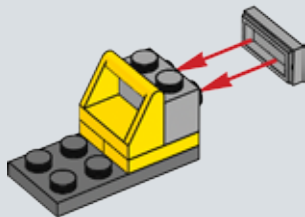

11

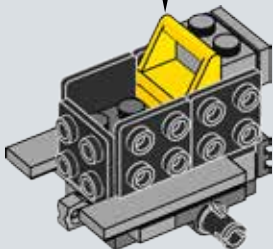

8

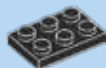

1x



1x

12

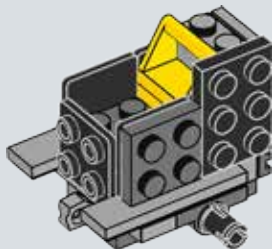

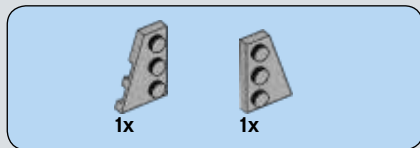

13

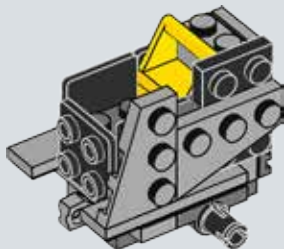

14

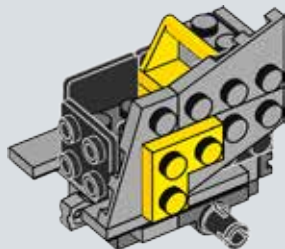



1x



1x

15

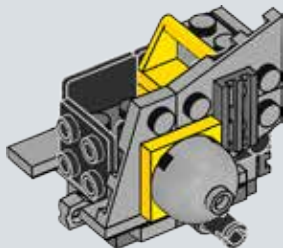

10

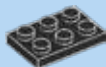

1x



1x

16

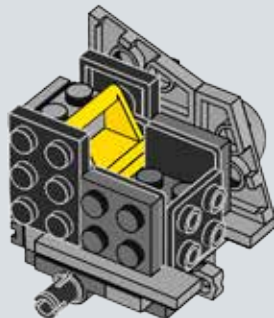



1x



1x

17

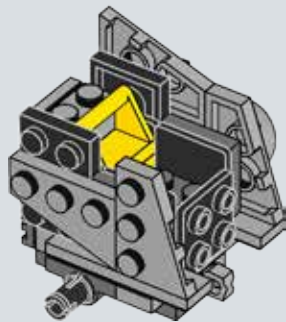

1x



1x

18

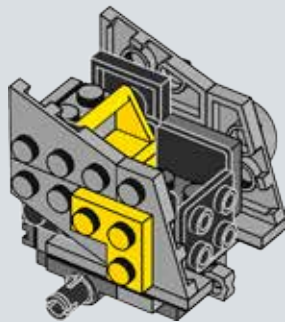



1x



1x

19

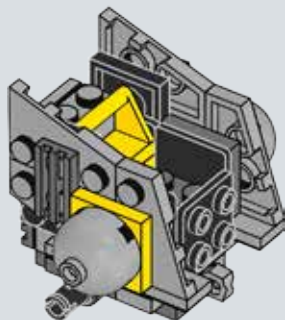



20

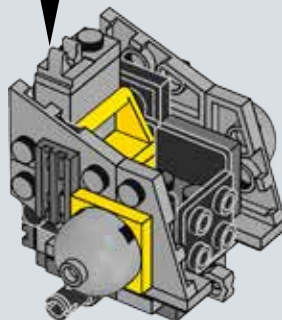
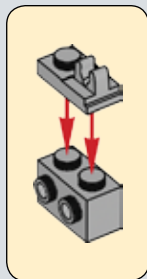

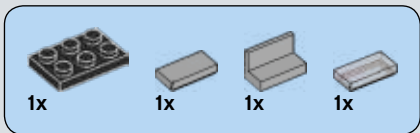

21

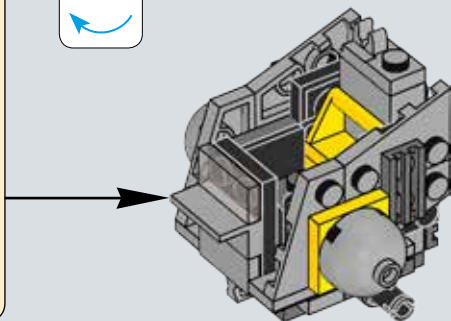
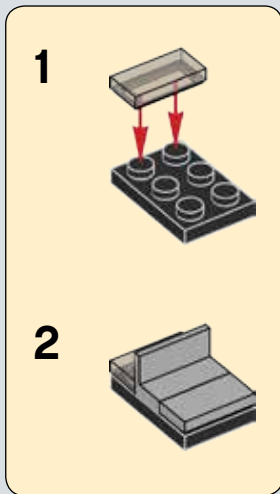

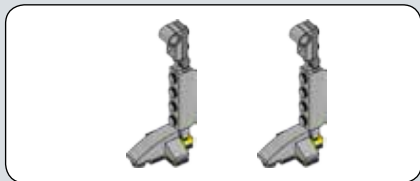

22



23





1x

24



16



1x

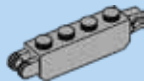

1x

25

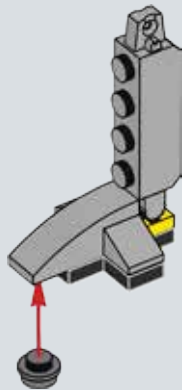

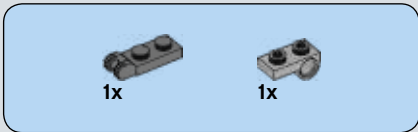

26

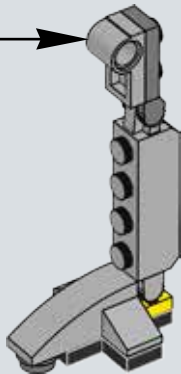
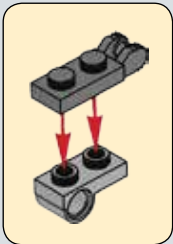

2x

27

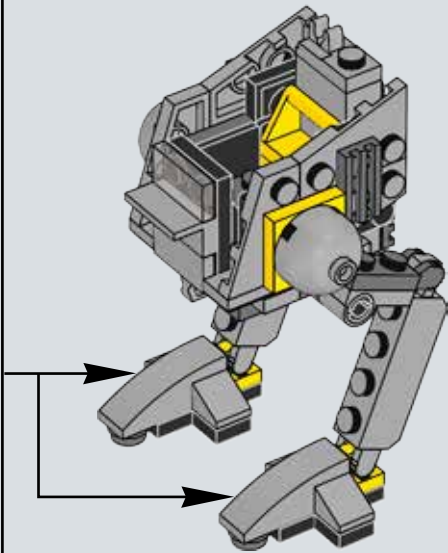

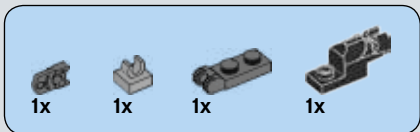

28

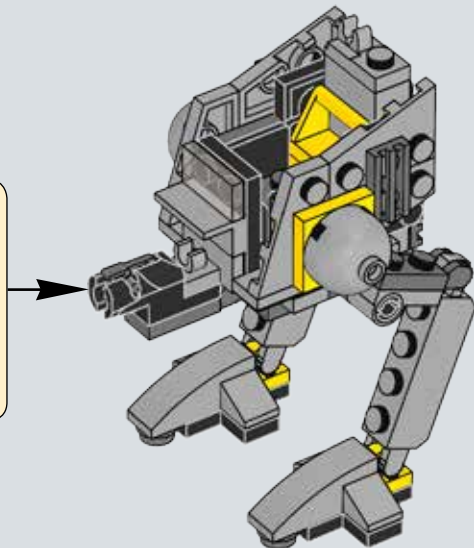
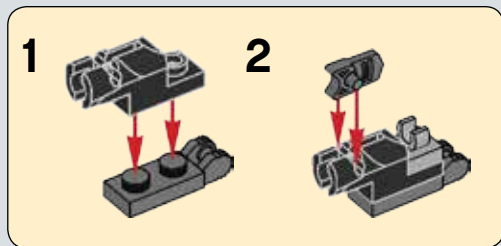



1x

29

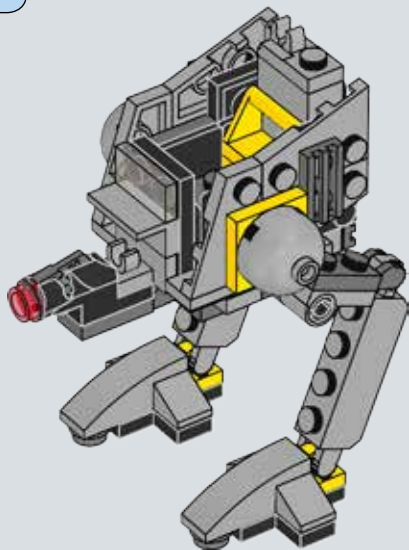

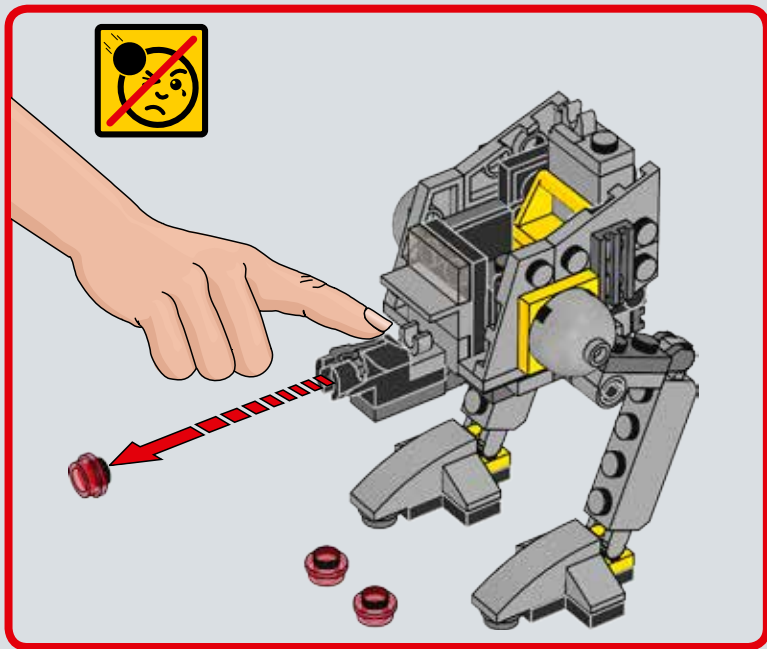

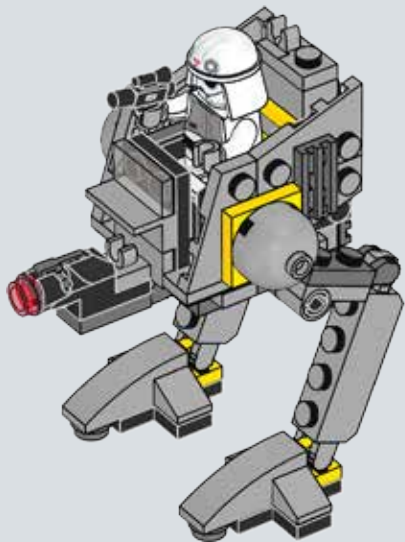



Customer Service

Kundenservice

Service Consommateurs

Servicio Al Consumidor

LEGO.com/service or dial



00800 5346 5555 :



1-800-422-5346 :



LEGO

**STAR
WARS™**

75128



75127



MICROFIGHTERS



75125 + 75126



75127 + 75128



75129 + 75130





GEWINNE



Erzähle uns auf
www.LEGO.com/productfeedback

etwas über die Erfahrungen, die
du mit diesem LEGO® Set gemacht
hast, und sichere dir die Chance auf
einen coolen LEGO Preis!

GAGNE



Rends-toi sur
www.LEGO.com/productfeedback

et donne-nous quelques commen-
taires sur ce produit LEGO® pour
avoir une chance de gagner un
prix LEGO !

GANAN



Visita
www.LEGO.com/productfeedback

y envíanos tu opinión acerca de este
set LEGO®. ¡Participarás en el sorteo
de un premio LEGO!

获取奖品



登录
www.LEGO.com/productfeedback

给出关于此乐高®套装的简短反馈，
就有机会获得炫酷乐高奖品

LEGO and the LEGO logo are trademarks of the LEGO Group. ©2016 The LEGO Group.
© & ™ Lucasfilm Ltd.

6143146