



# Friends



41107



[LEGO.com/popstar](http://LEGO.com/popstar)

1



2



3



4





1



1



2



3



2





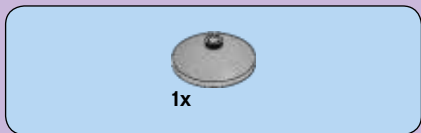
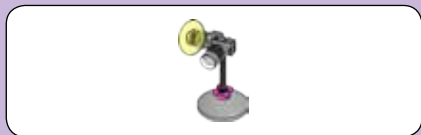

1

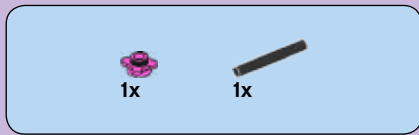

2



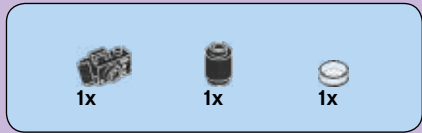

3

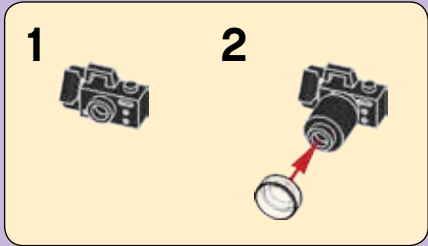

4

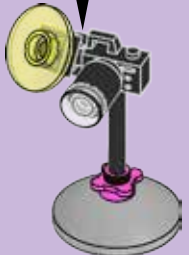
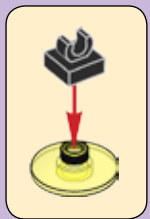



**1**



**1**



**2**



**3**



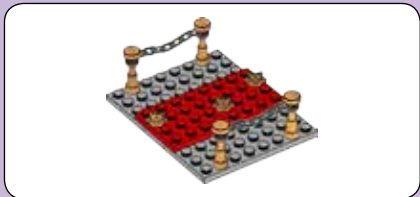

1



8



2





3

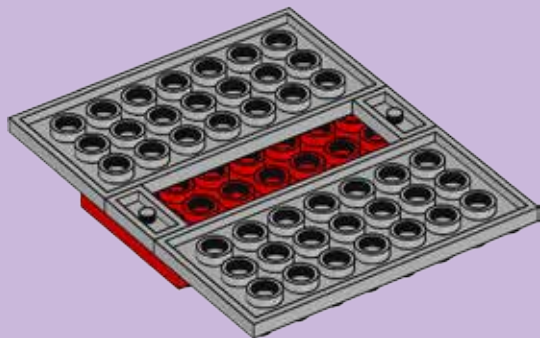

4

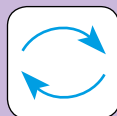





2x

5



4x

6



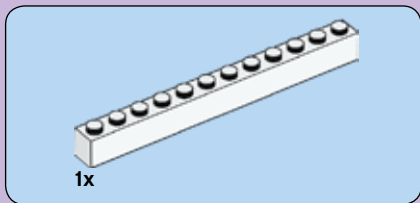

1

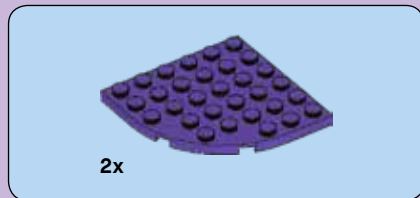
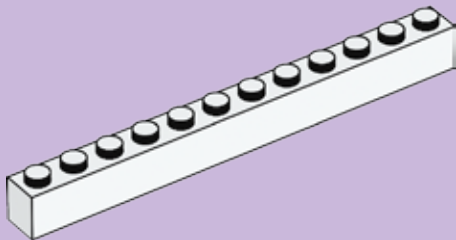

2

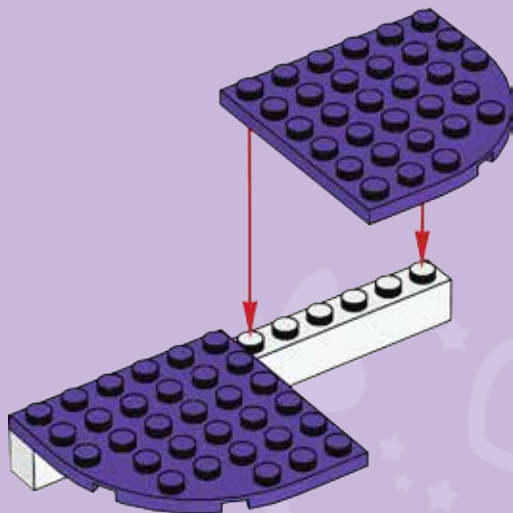

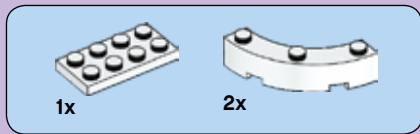

3

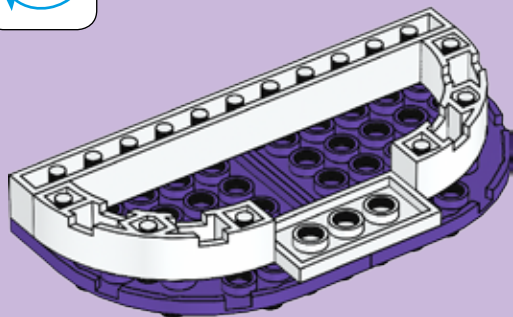
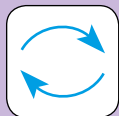

4

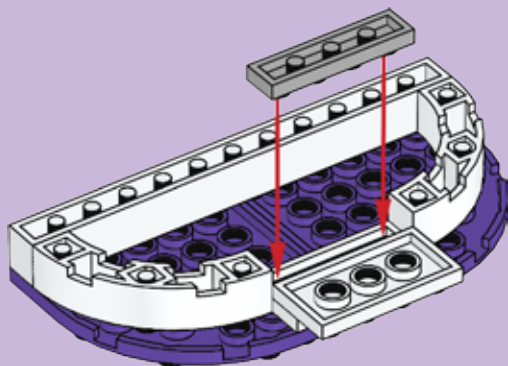

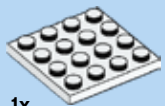

1x

5

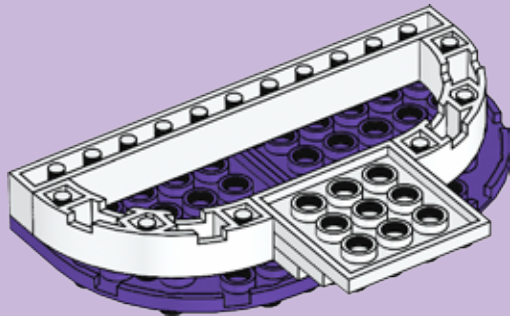

4x



2x

6

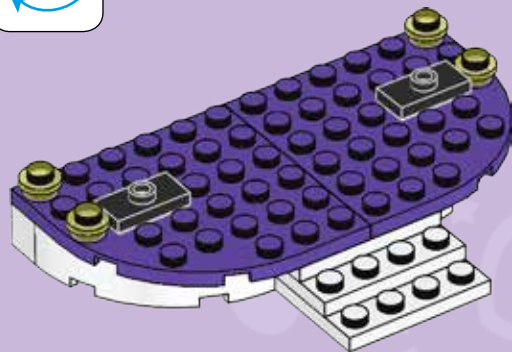
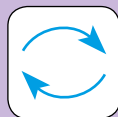

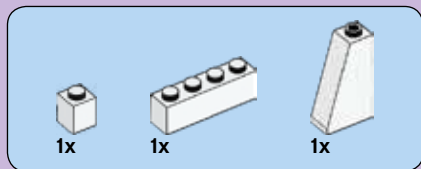

7

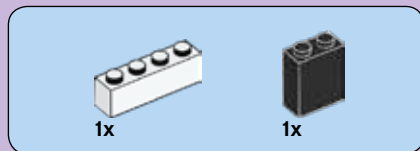
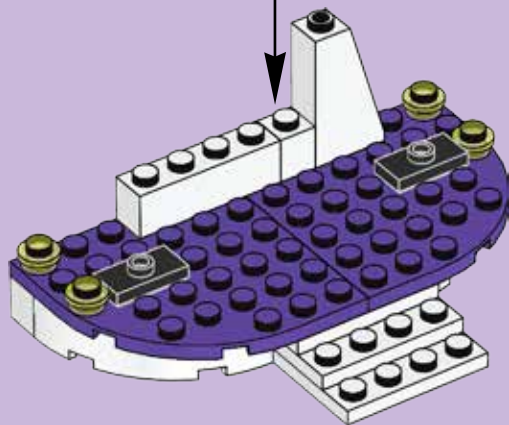

8

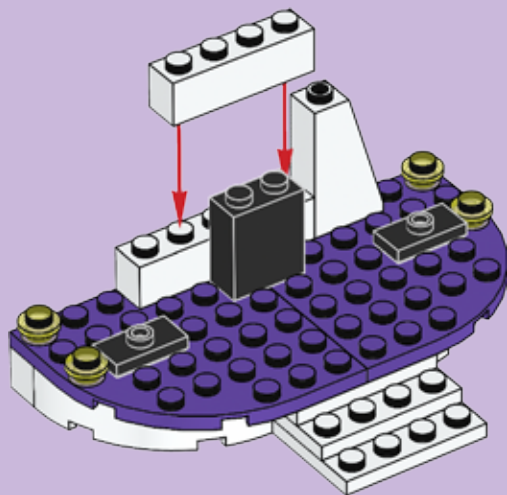





1x



2x

# 9

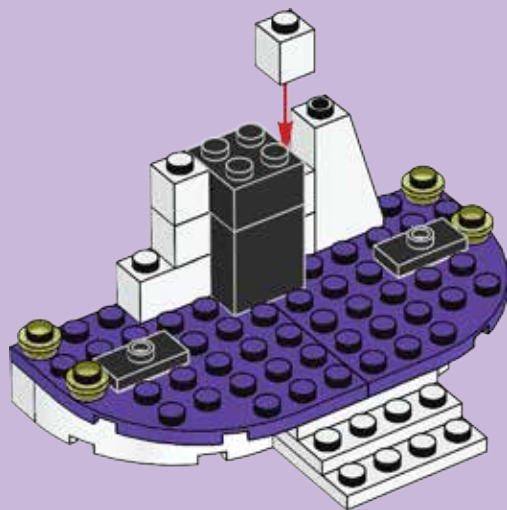

1x



1x

# 10

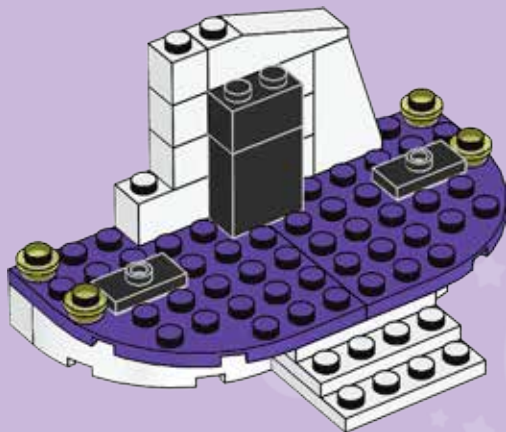





1x



1x



1x

# 13

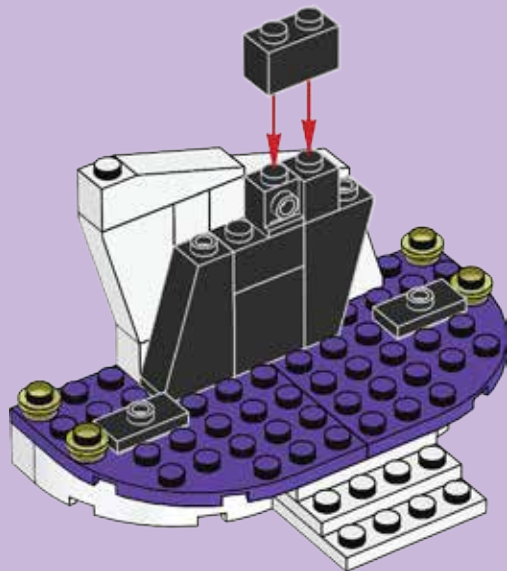

1x



1x



1x



1x

# 14

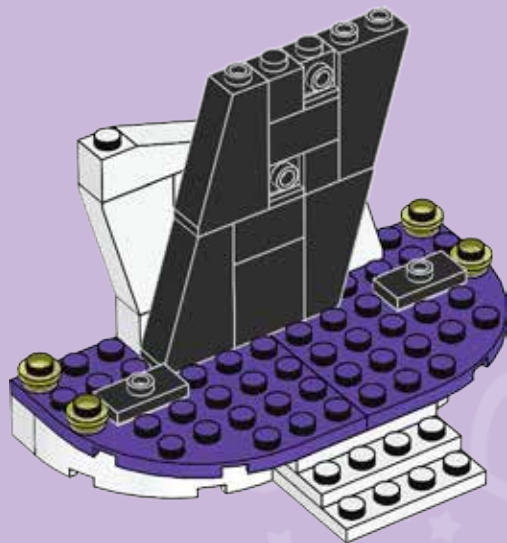



1x



1x

# 15

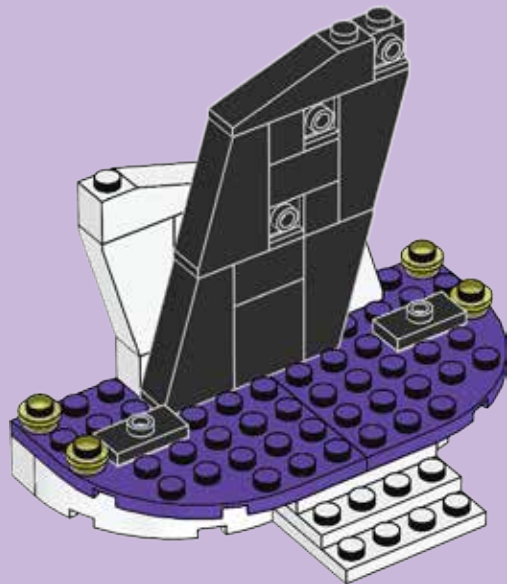

18



2x



3x

# 16



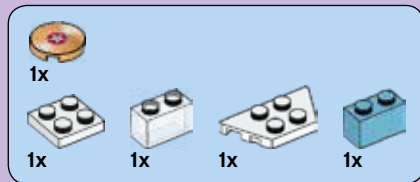

17





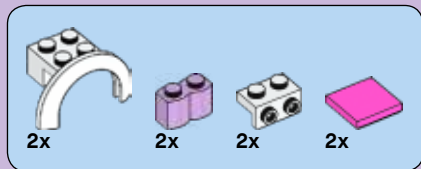

18

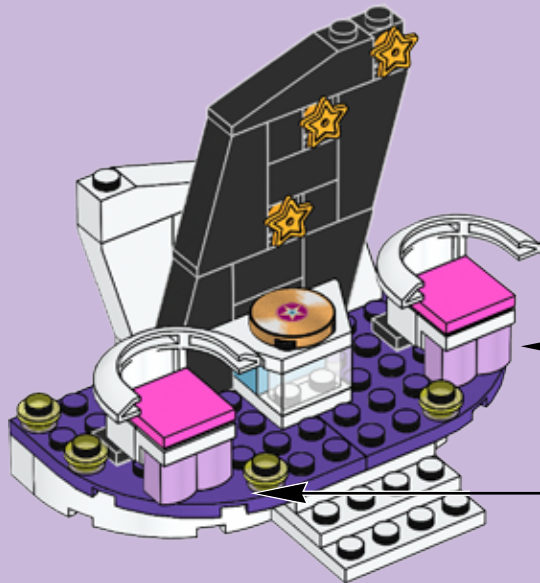
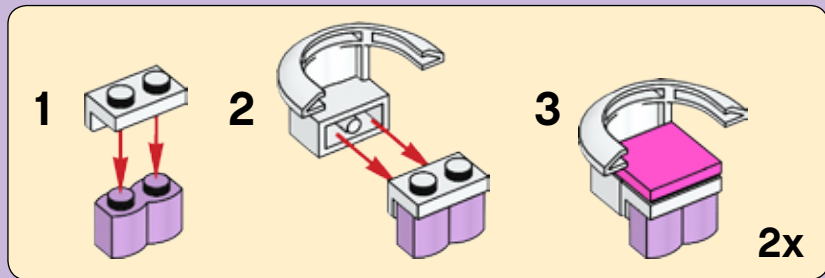

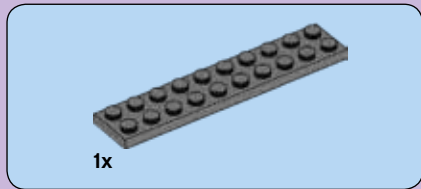
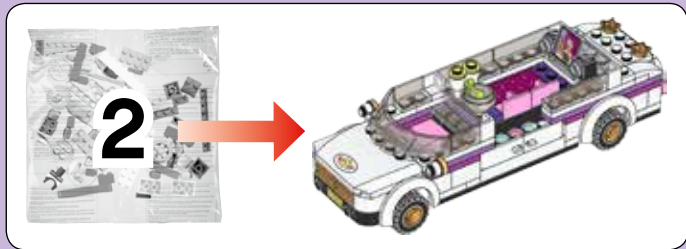

1

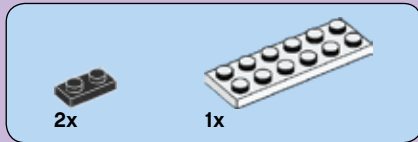
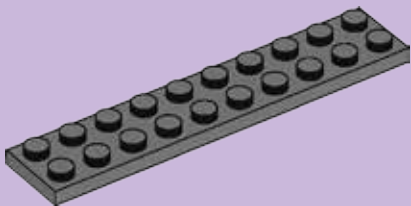

2

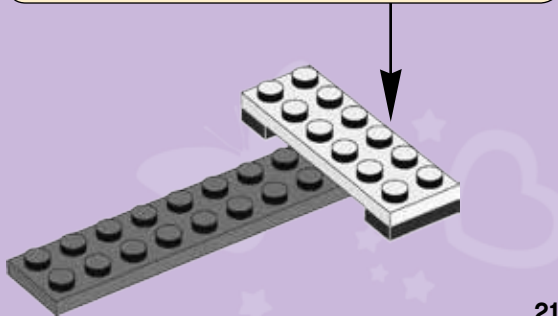
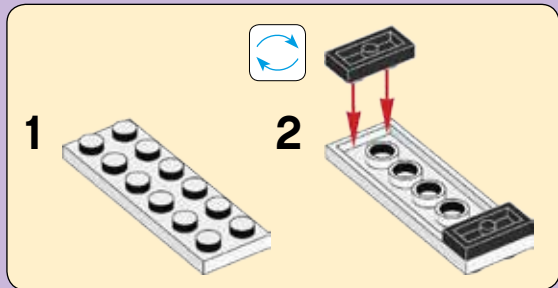

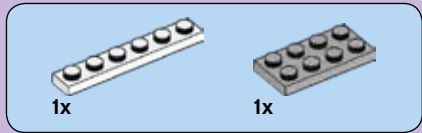

3

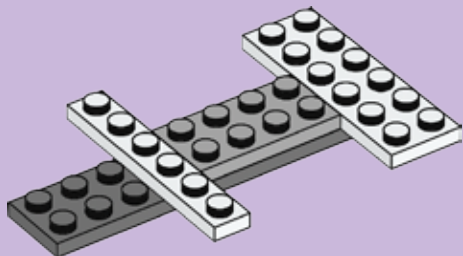

4

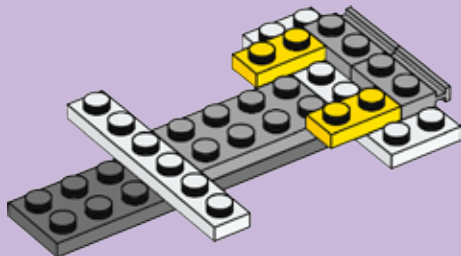

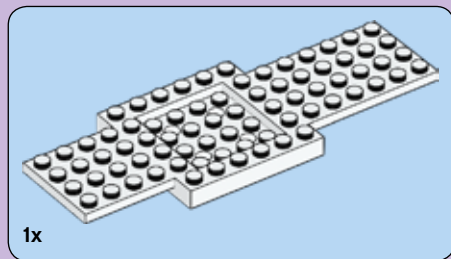

5

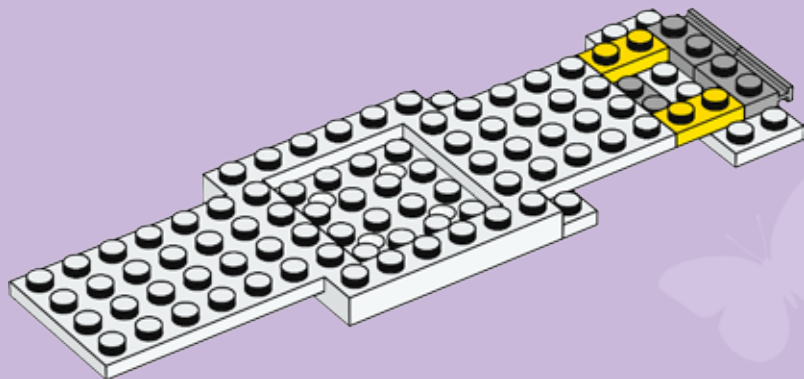

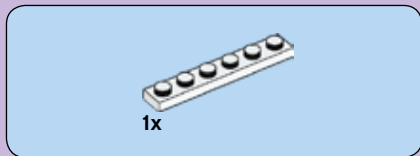

6

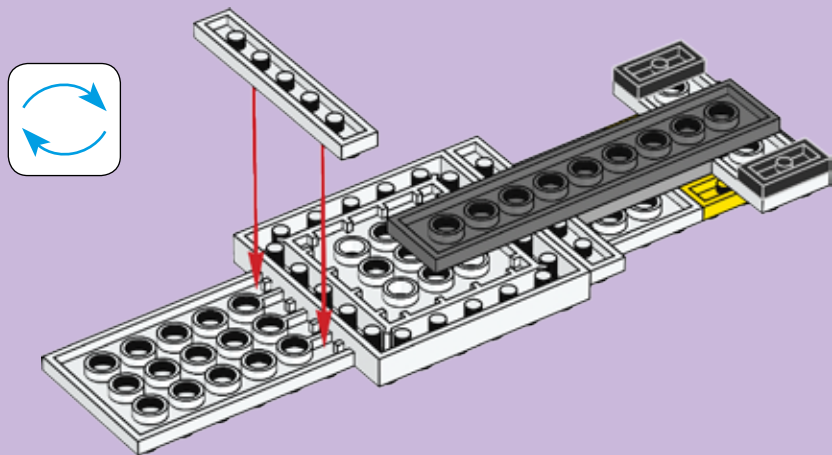



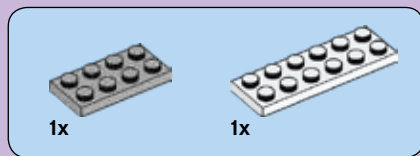

7

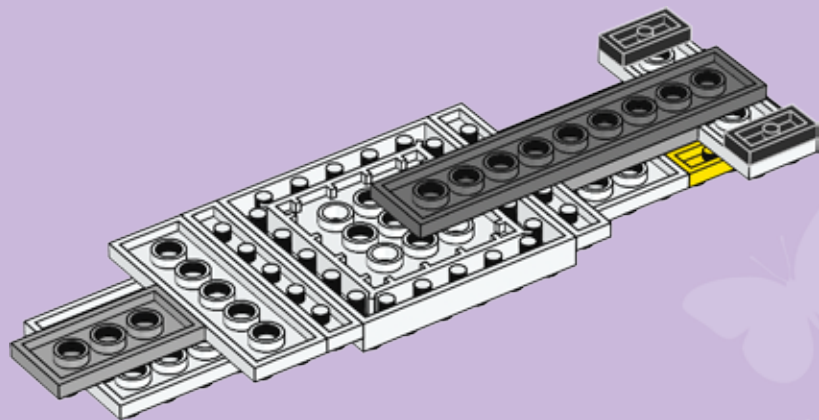

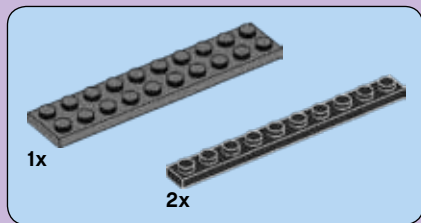

8

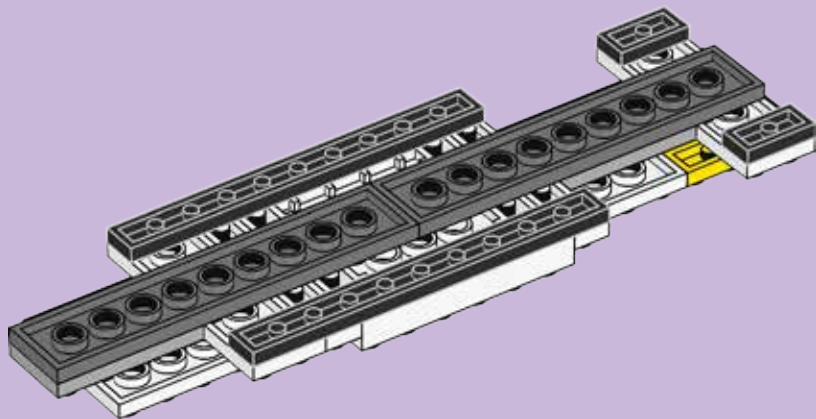



9

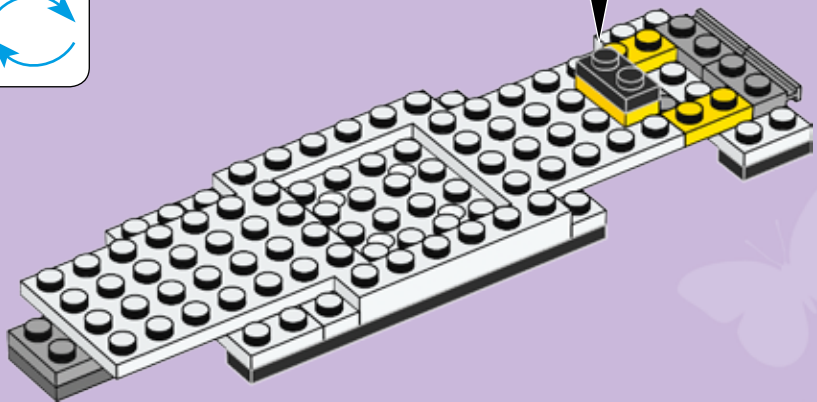
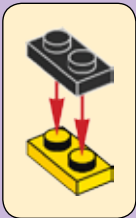



2x



1x

# 10

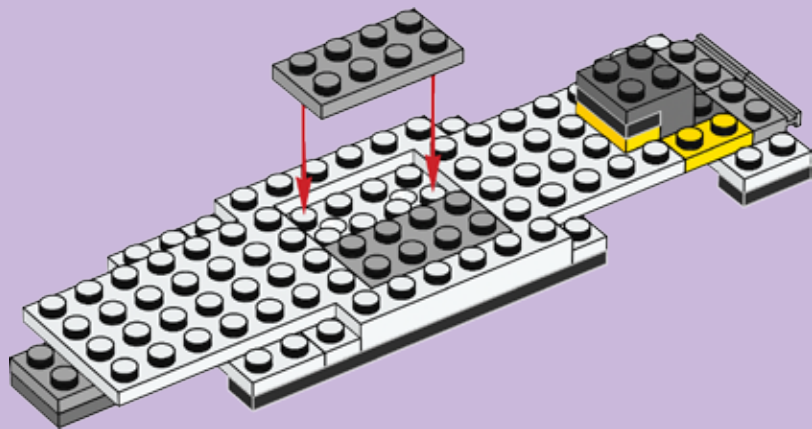

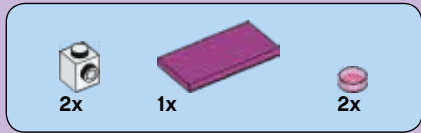

11

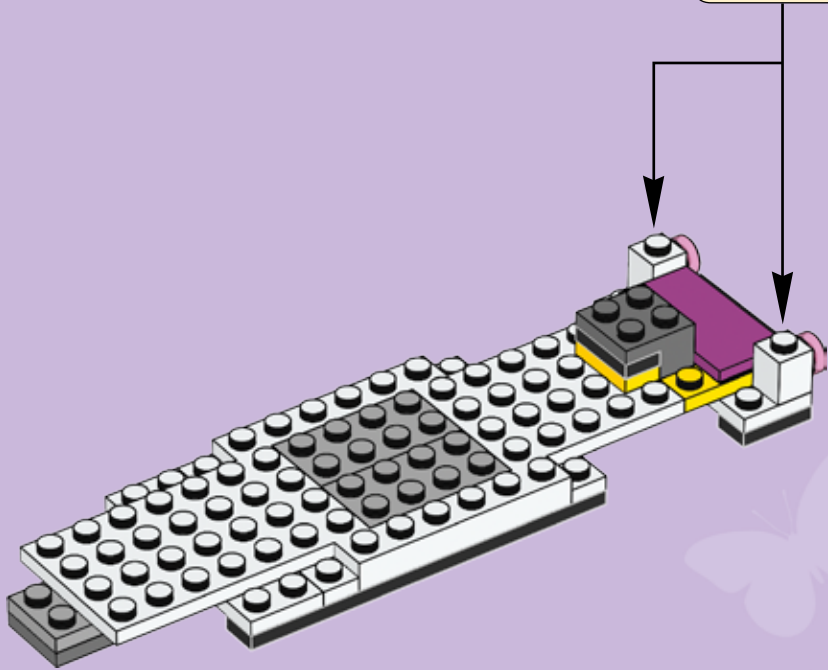
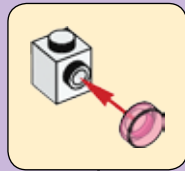



2x



2x

# 12

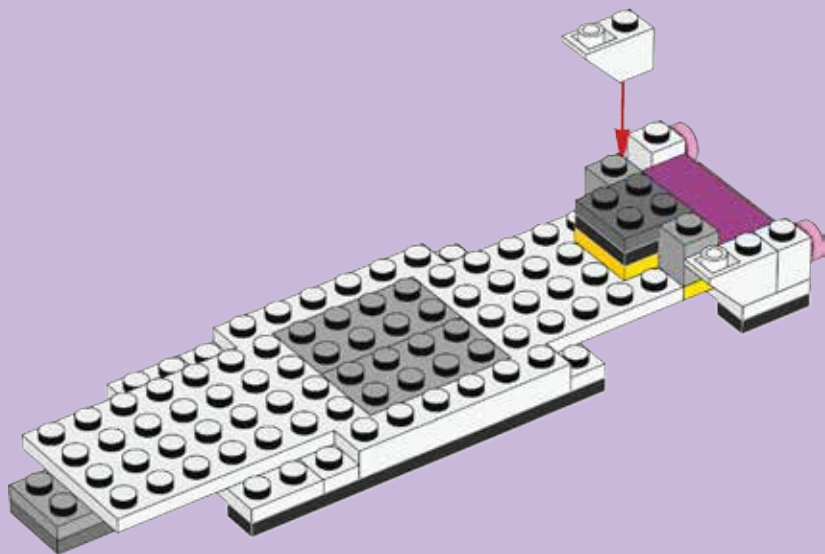



2x



1x

# 13

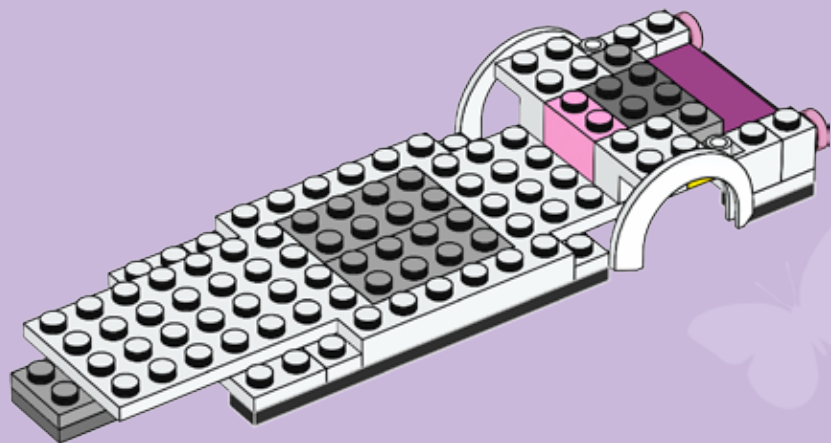

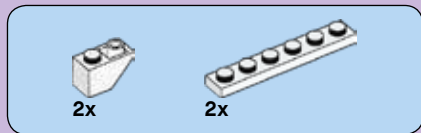

14

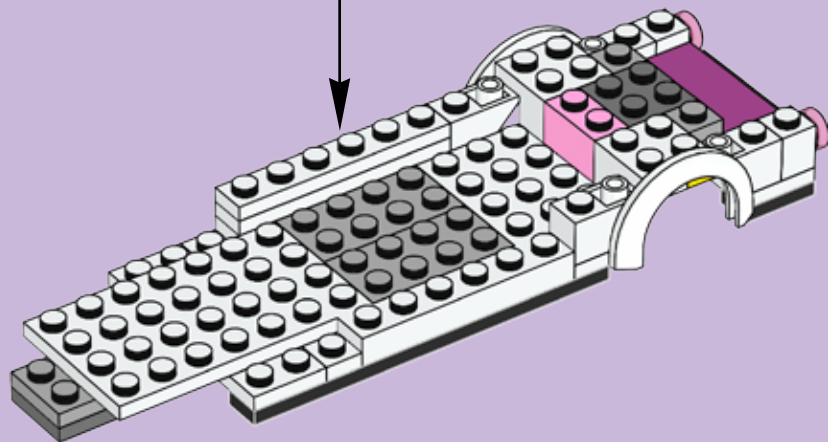
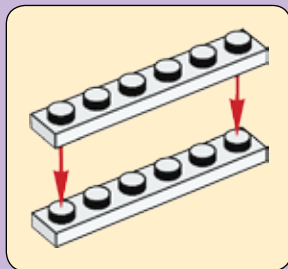



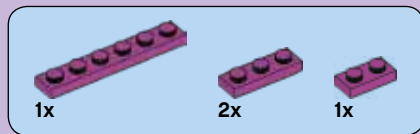

# 15

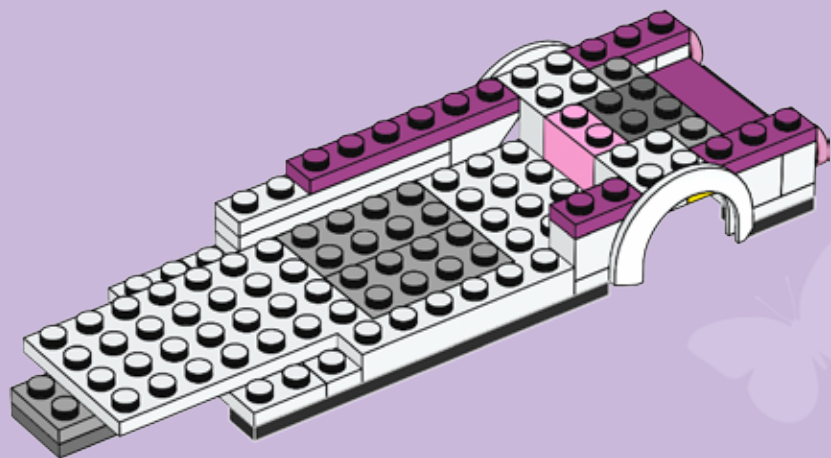

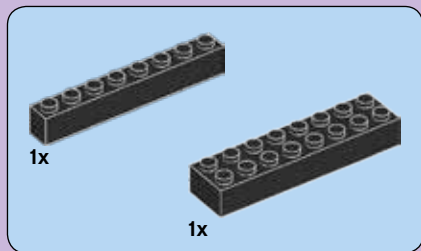

16

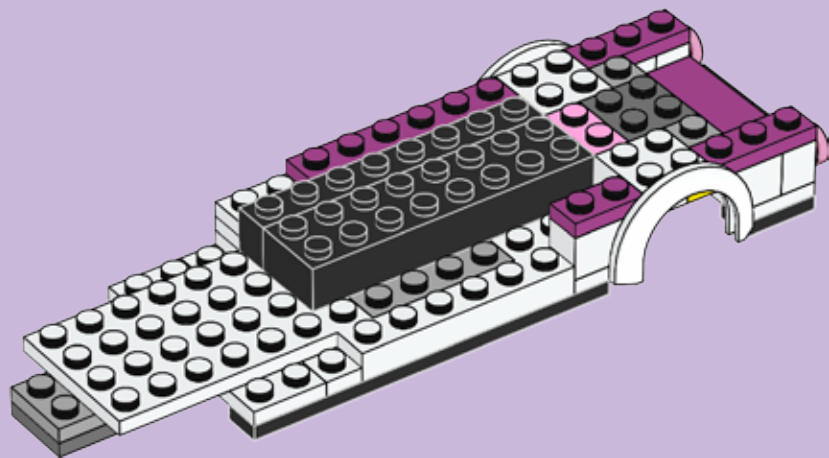



1x



2x



2x

# 17

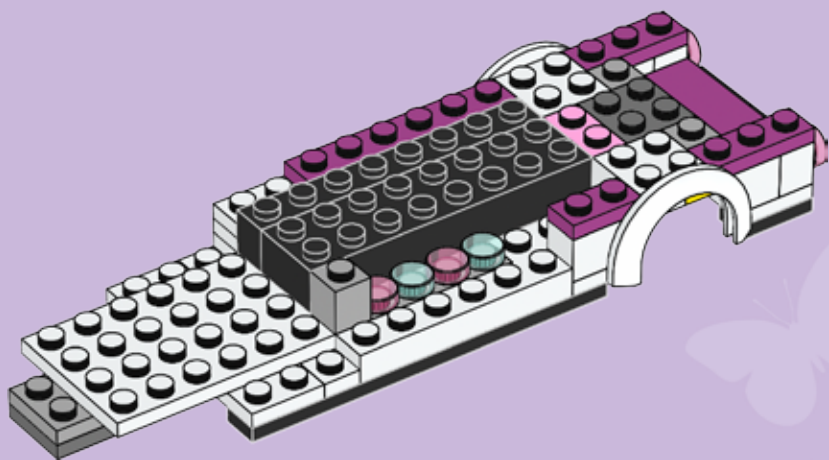



2x



2x

# 18

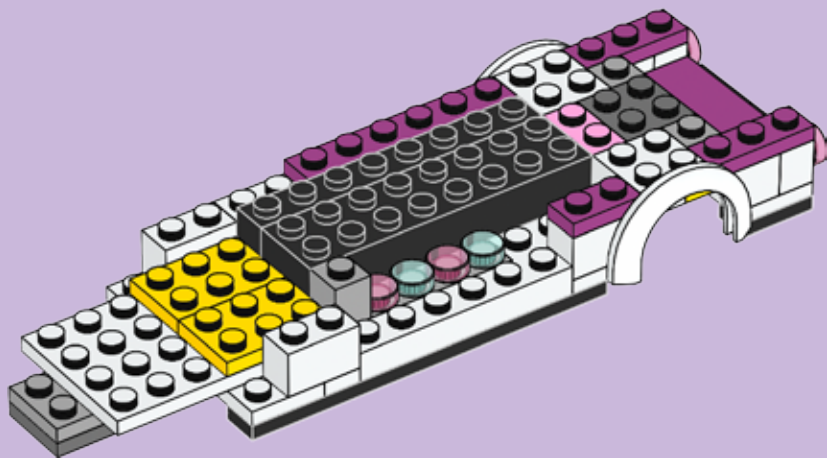



1x



1x



2x

# 19

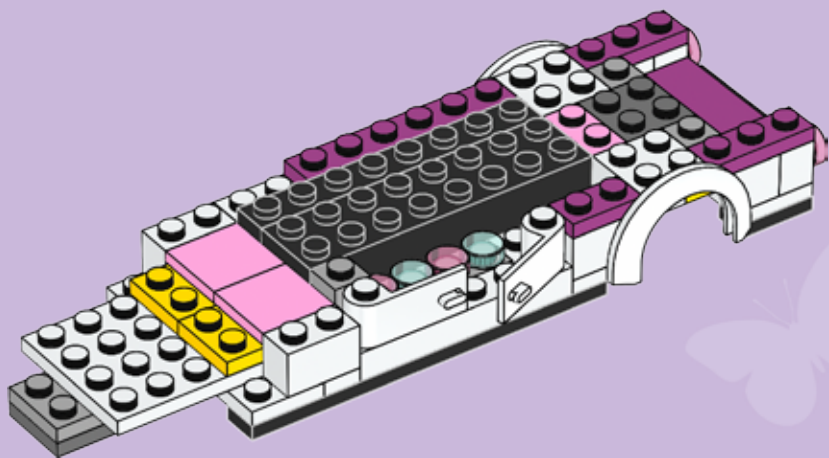



2x



2x

# 20

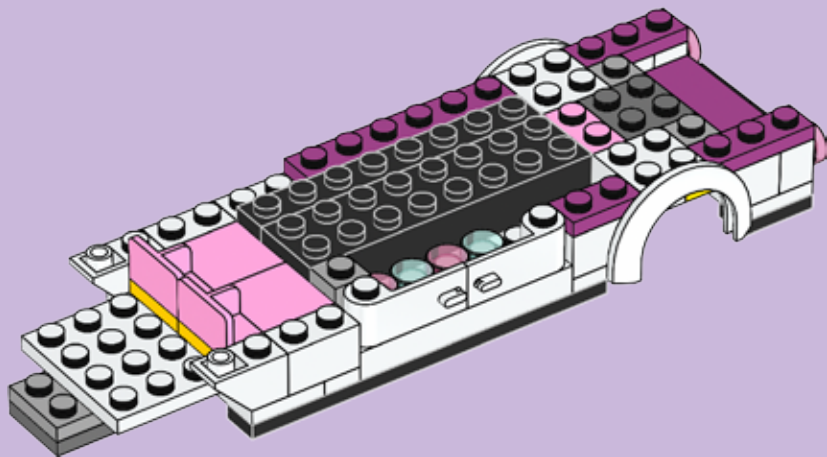

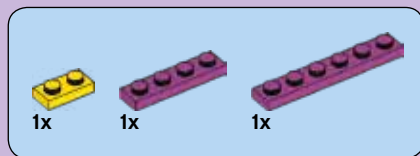

# 21

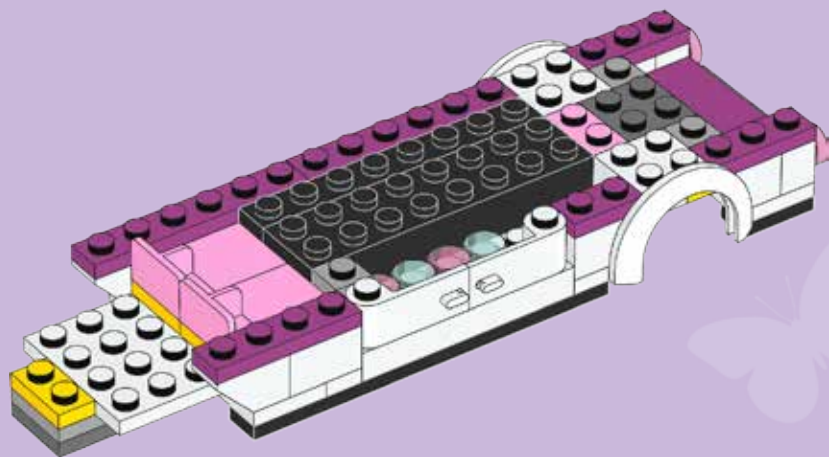



22

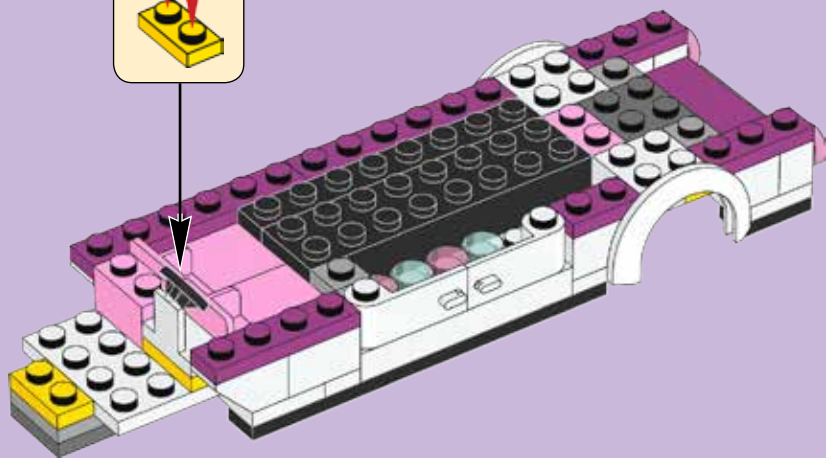
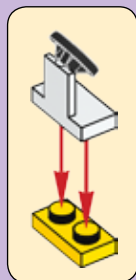





# 23

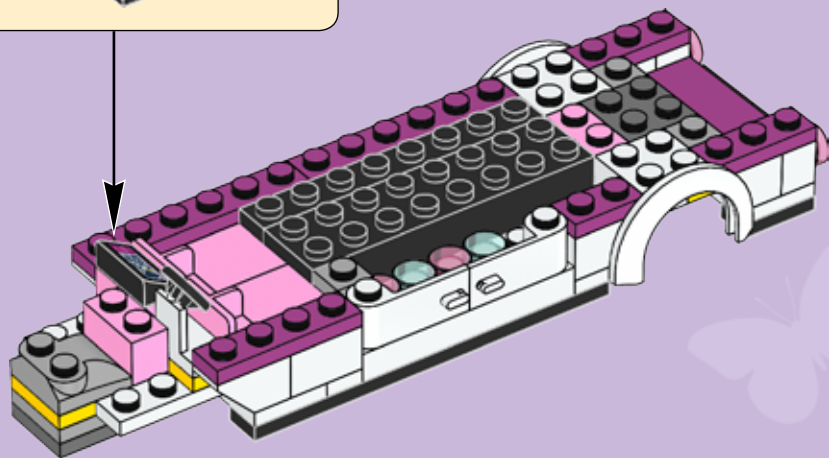
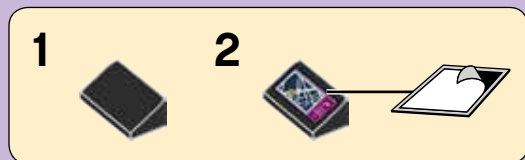



2x

24

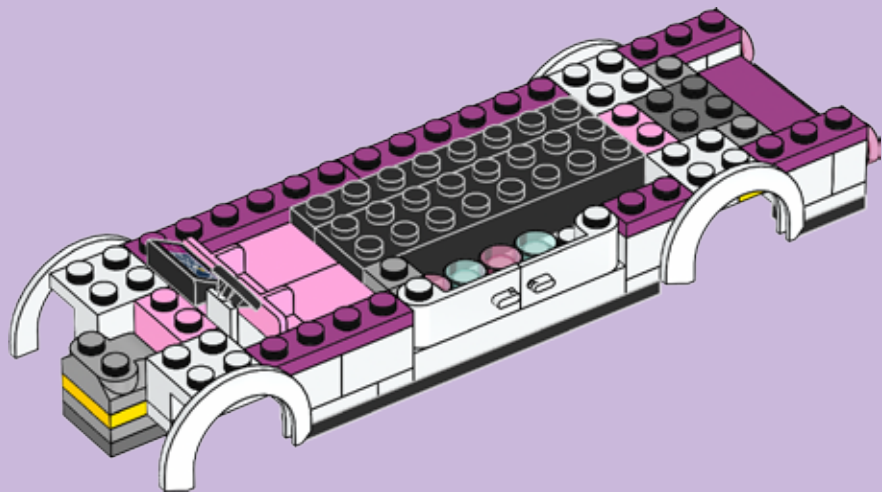

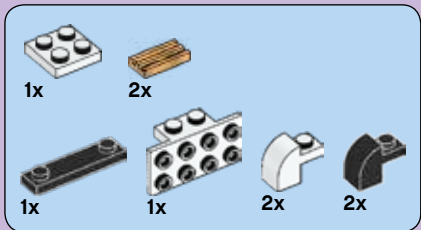

# 25

1



2

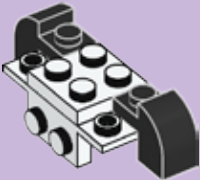

3

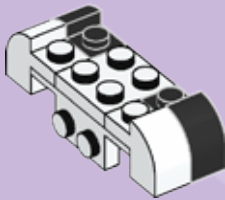

4

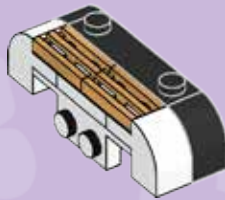

5

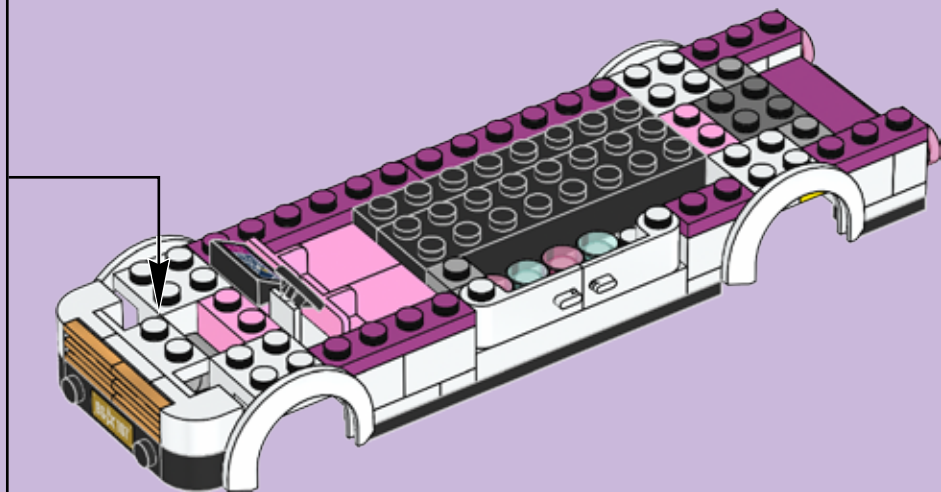
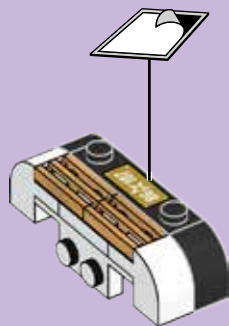



2x

26

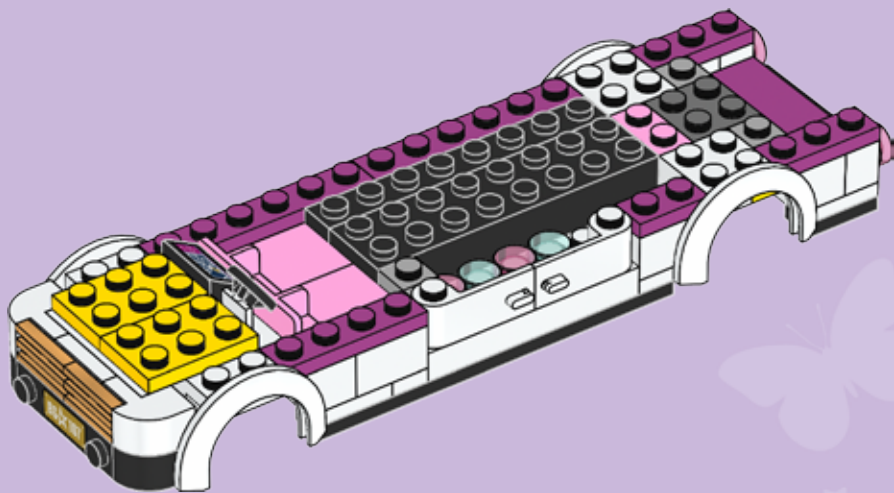

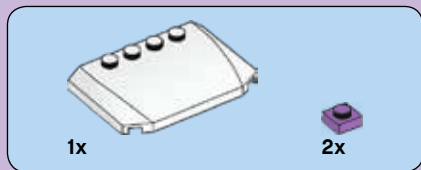

27

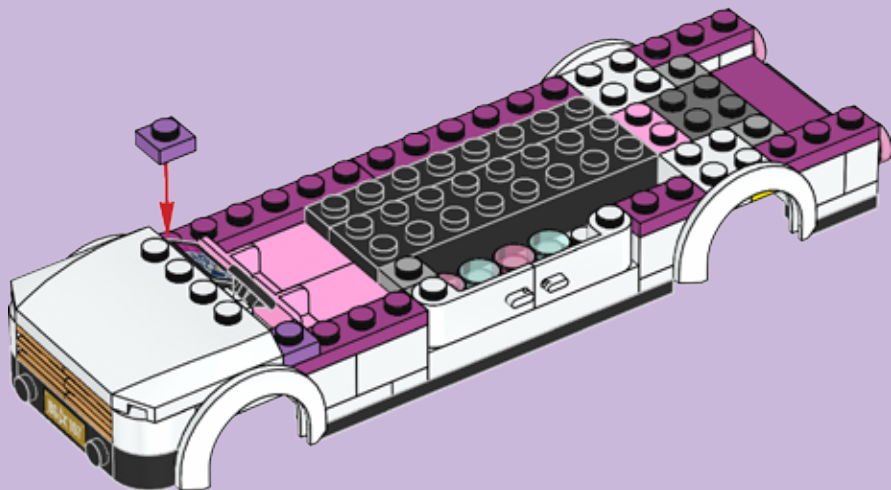

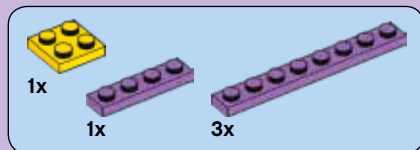

# 28

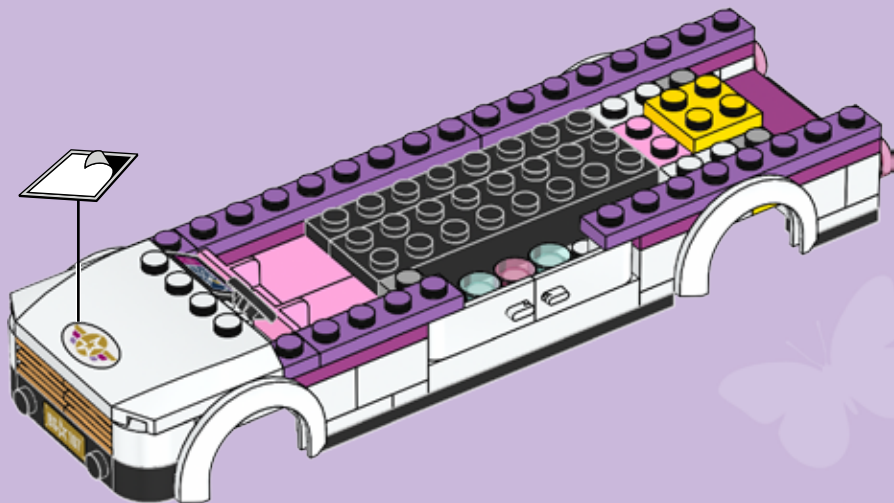



1x



1x



2x

# 29

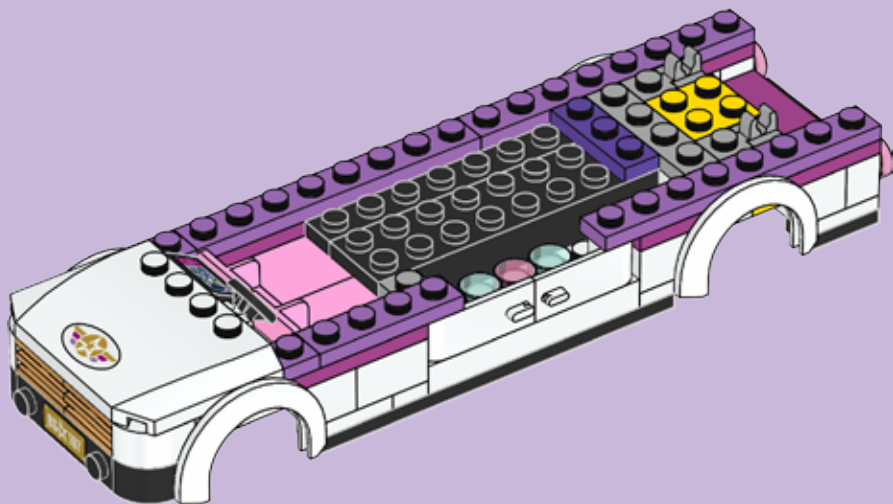





1x



2x



2x

# 30



2x

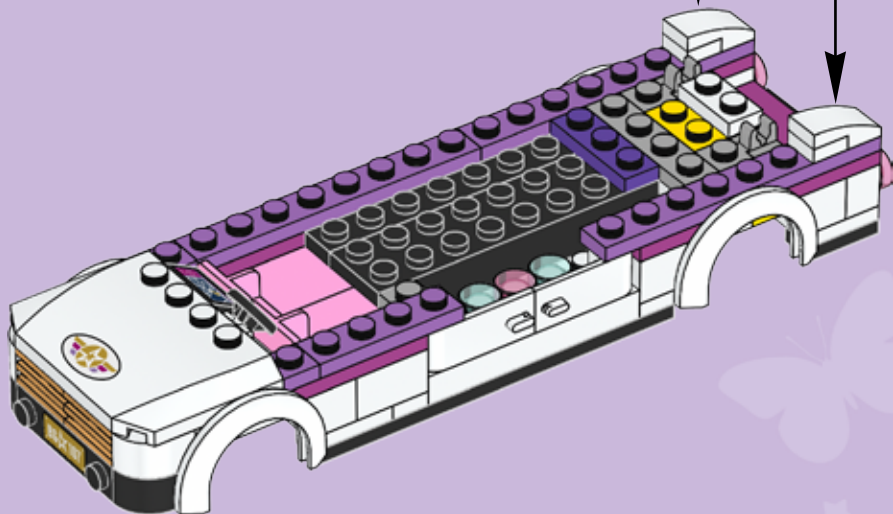

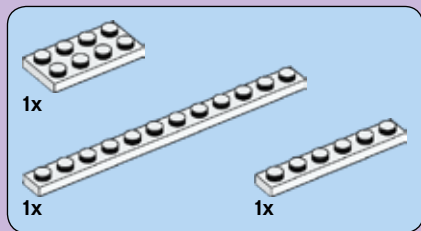

# 31

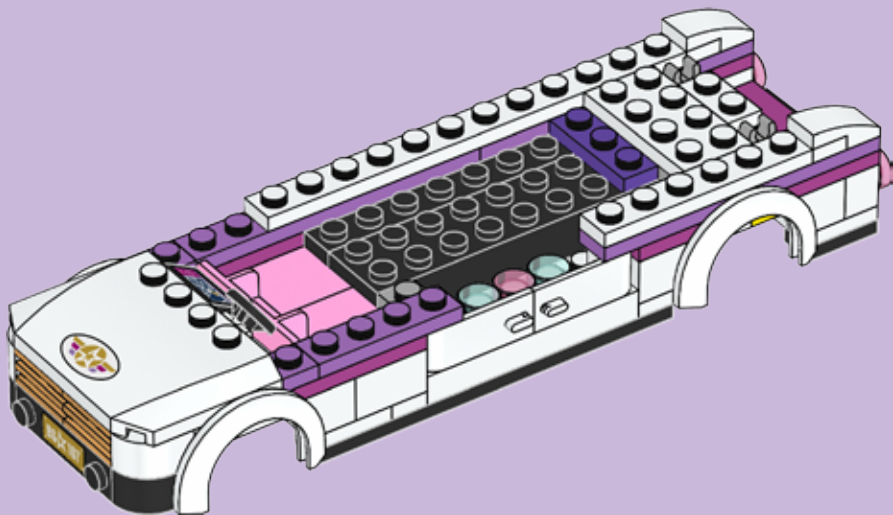



1x



1x



2x



1x



2x



2x

# 32

## 1



## 2



## 3

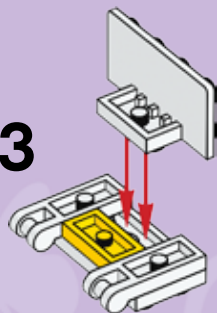

4

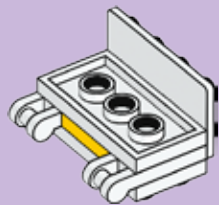

5

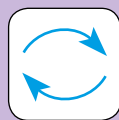

6

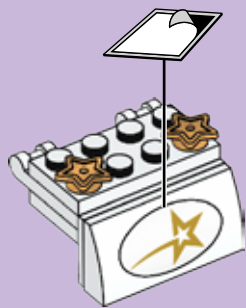

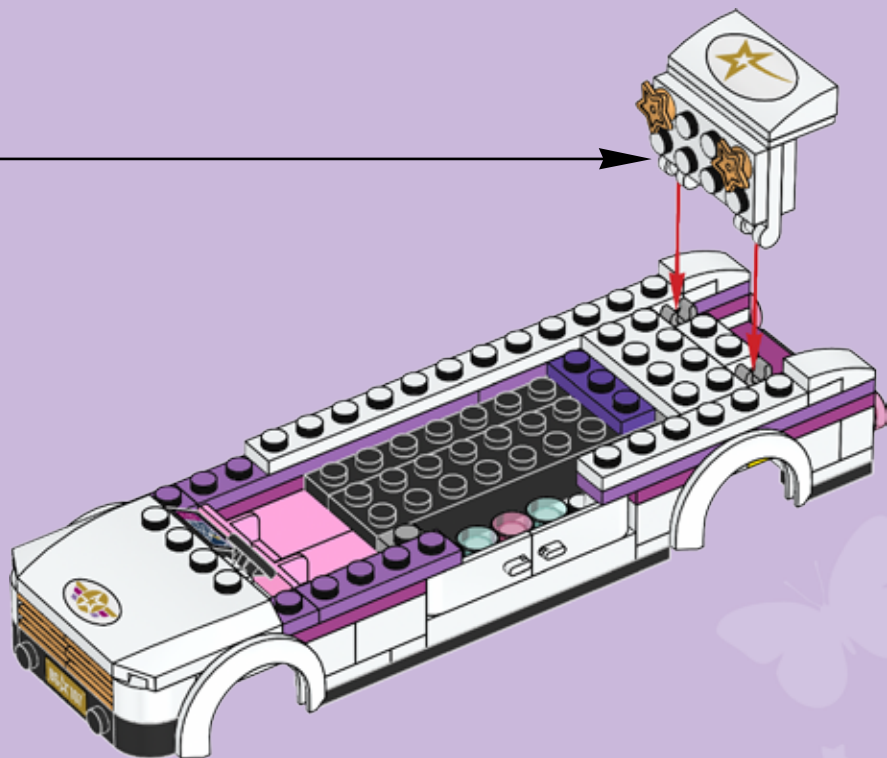



1x

# 33

1



2



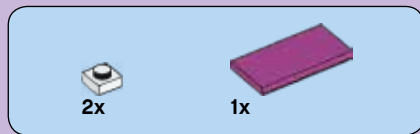

# 34

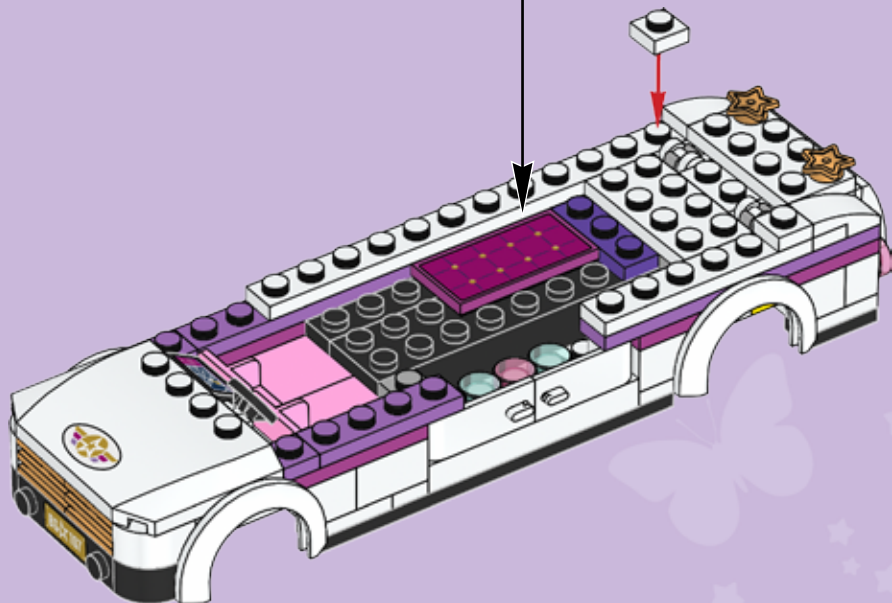



1x



1x



2x

# 35

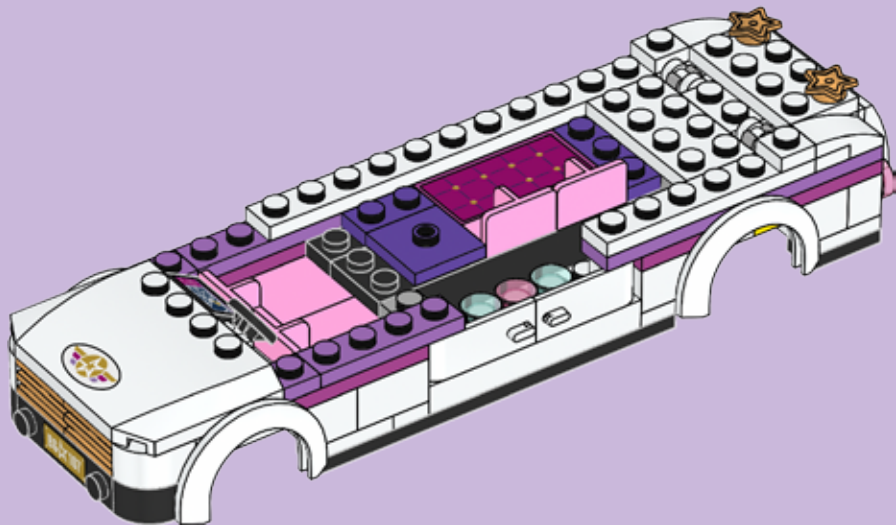





# 36

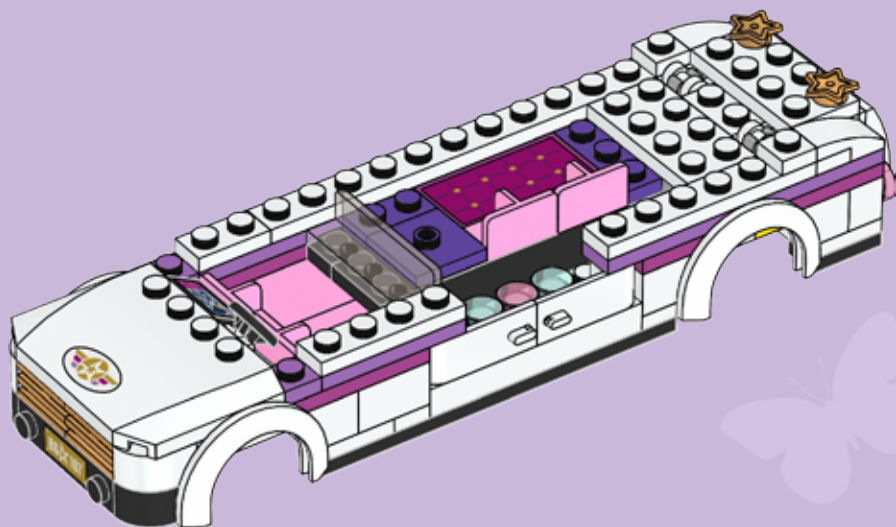



37

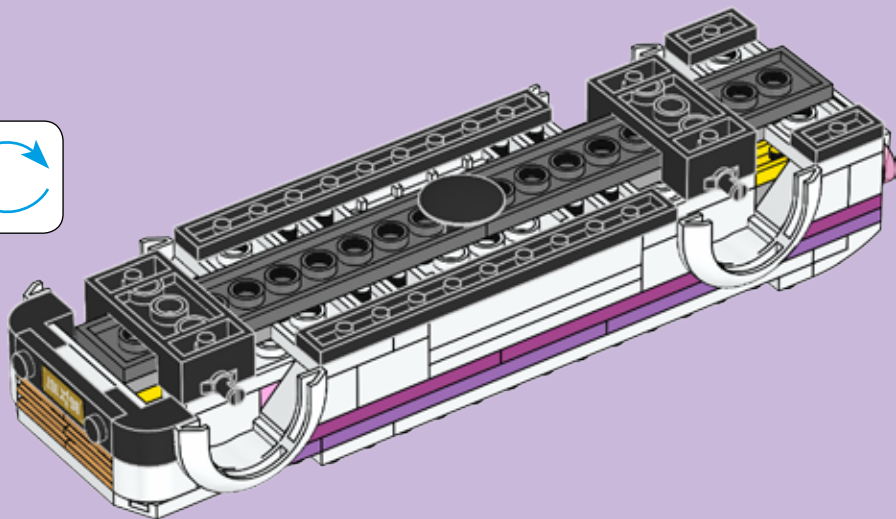
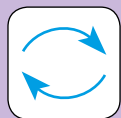



2x



2x

# 38

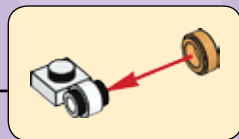
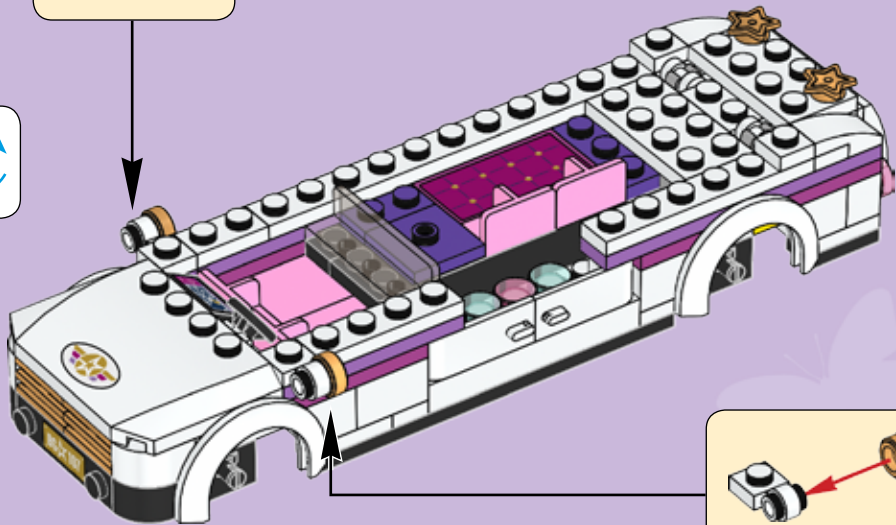
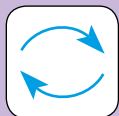
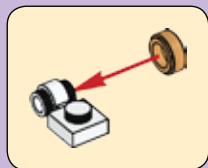



2x



1x

# 39

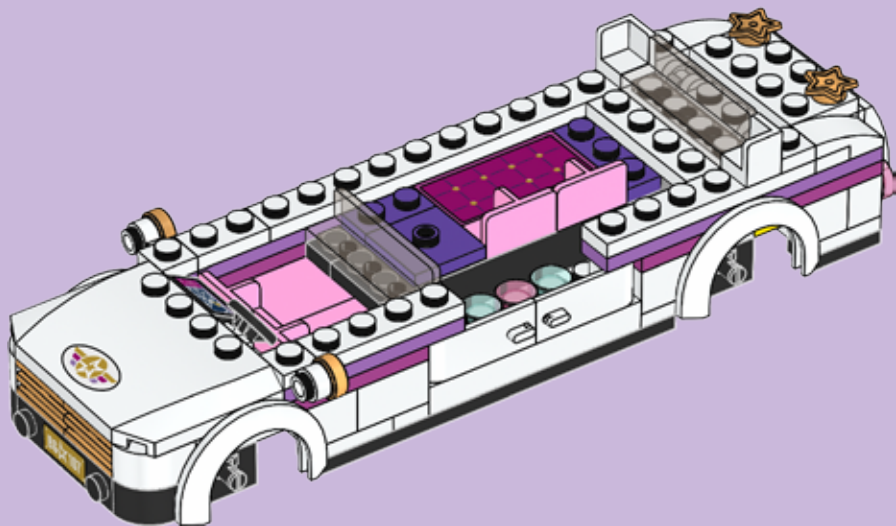



1x



1x

# 40

1

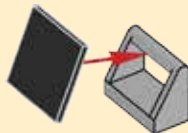

2

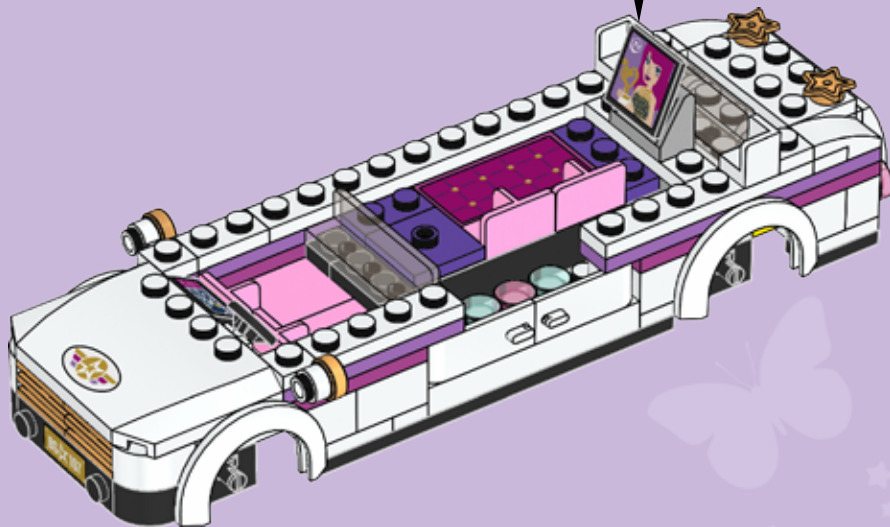
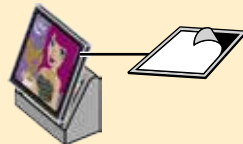



2x



4x

# 41

1



2



2x

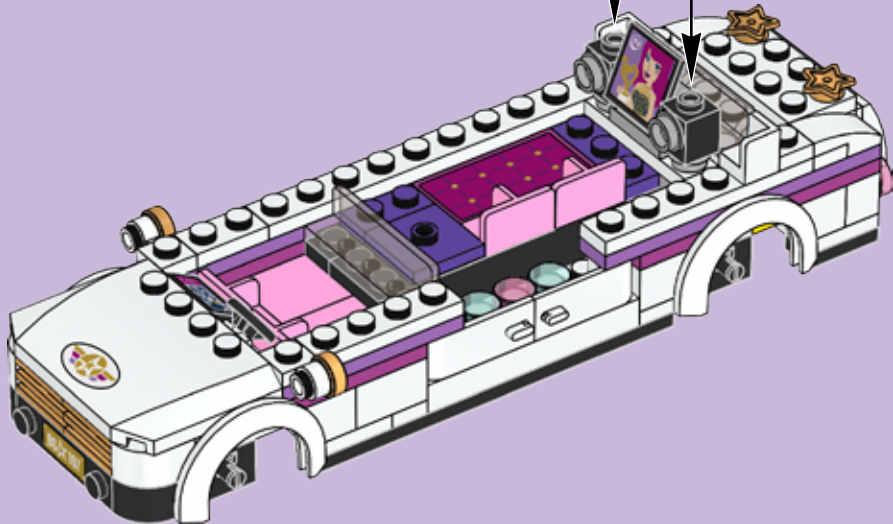



3x

42

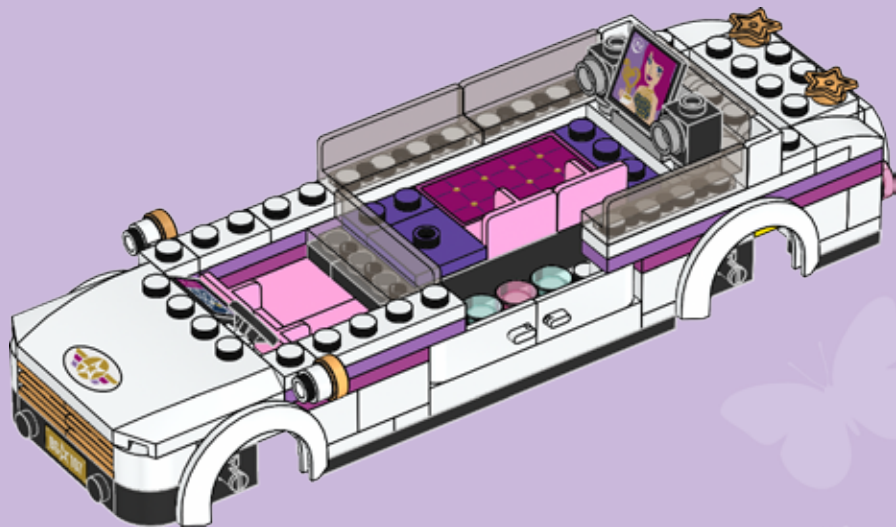



2x



2x

# 43

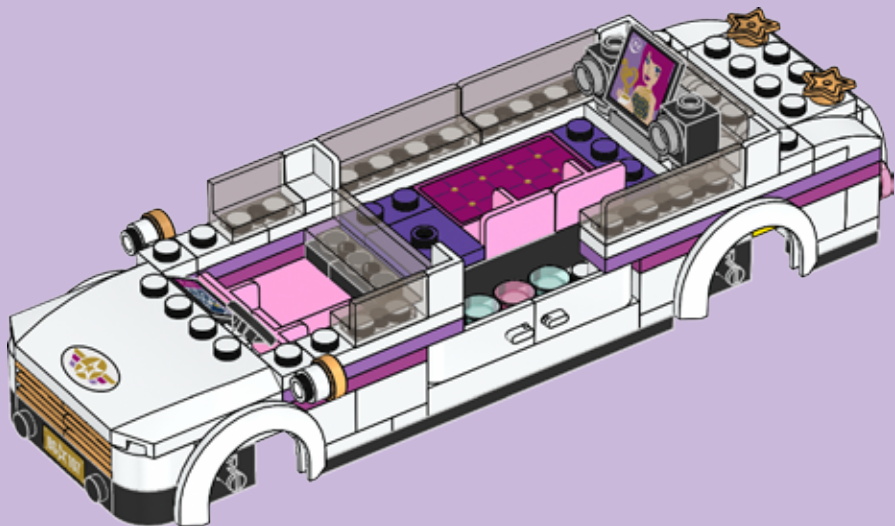



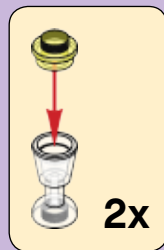

44

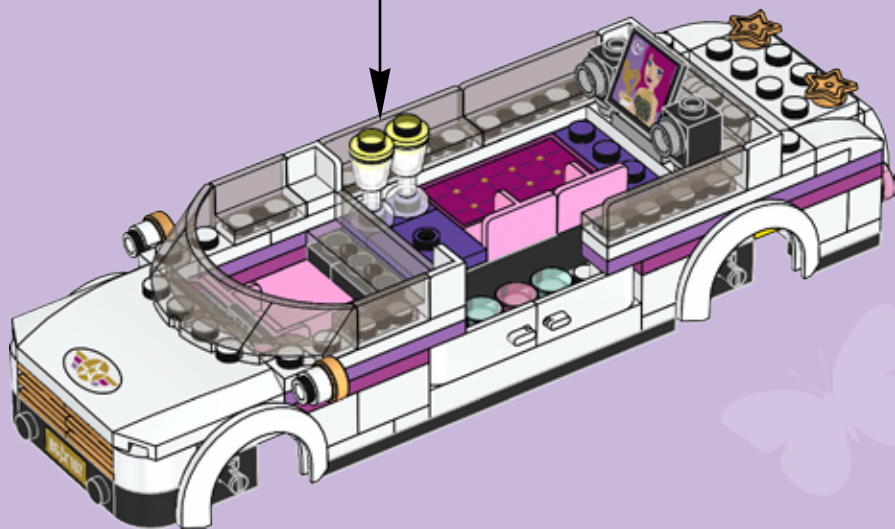



1x



1x



# 45

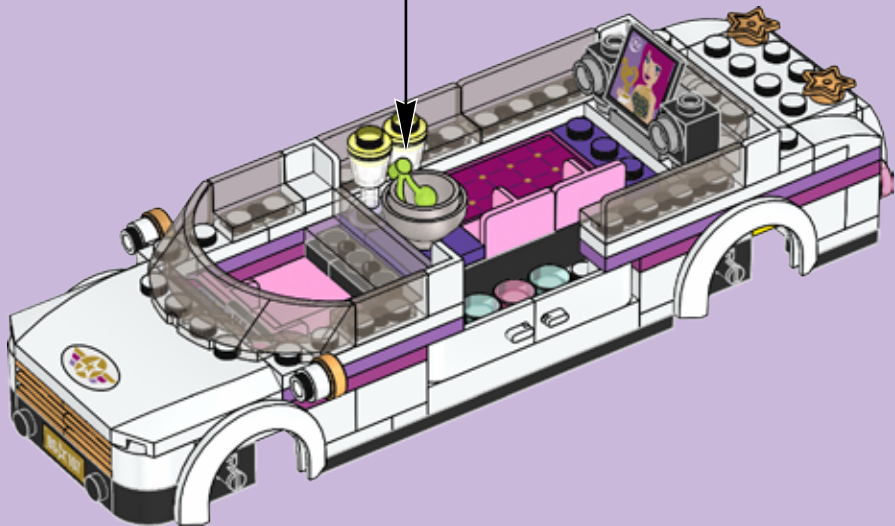



4x



4x

# 46

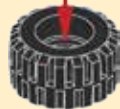
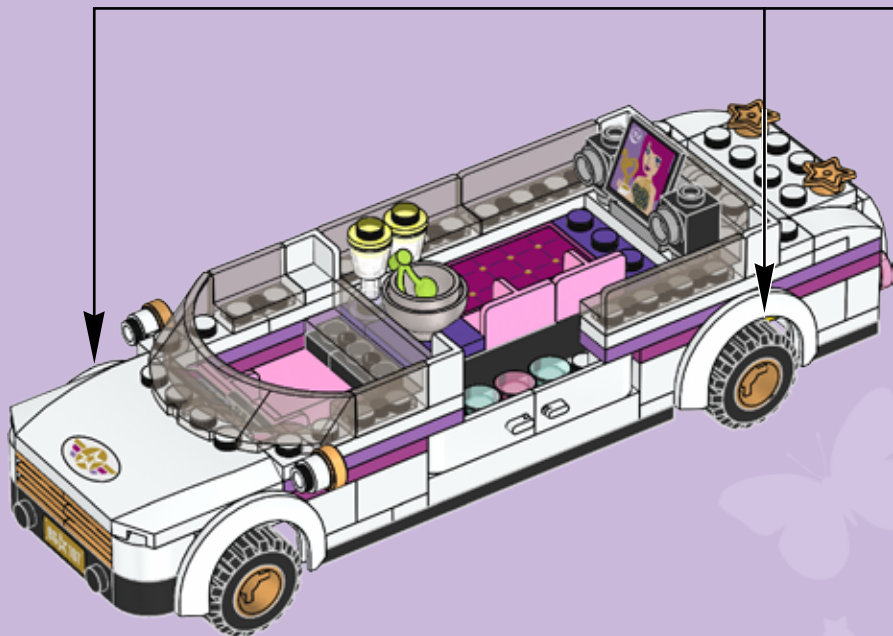

4x

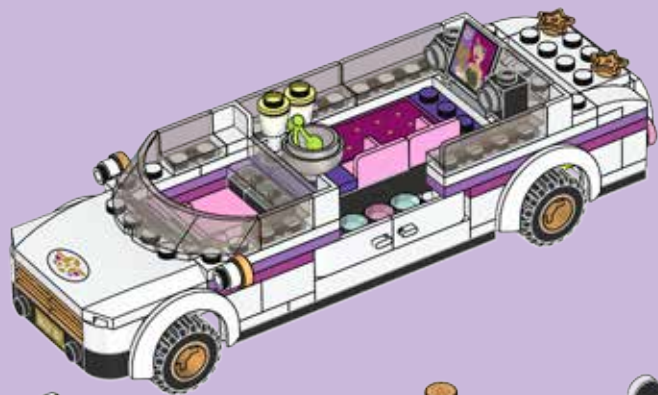



# Friends

41100



## Heartlake City



41099



41098



41101







1x  
6096991



1x  
6022579



1x  
6097098



3x  
6017001



3x  
4211389



1x  
4494475



2x  
4211398



2x  
4211445



4x  
4211395



1x  
4211357



2x  
4598526



2x  
4211568



4x  
4211525



1x  
6070564



1x  
6093054



2x  
6054406



4x  
4216479



1x  
6116295



3x  
4517993



2x  
4615728



4x  
6100629



1x  
4655695



1x  
4659770



1x  
6035470

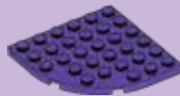

2x  
6022021



2x  
4490599



1x  
4585493



6x  
4649422



1x  
6115442



5x  
6070746



4x  
4538126



4x  
6116548



1x  
6102756



1x  
6092674



2x  
4619521



1x  
4619524



3x  
4625022



2x  
6056283



1x  
6096137



1x  
6043921



1x  
6115441



1x  
6018863



1x  
6112648



1x  
6112879



1x  
6112883



1x  
6019089



1x  
303521



2x  
4211407

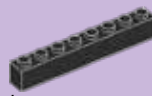

1x  
300826

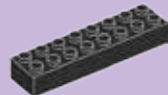

1x  
6037390



2x  
4210678

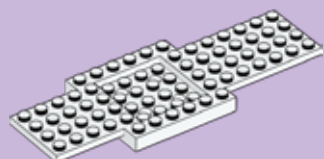

1x  
6109956

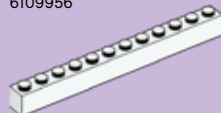

1x  
611201



1x  
4514842



2x  
447726

Customer Service

Kundenservice

Service Consommateurs

Servicio Al Consumidor

LEGO.com/service or dial



: 00800 5346 5555

: 1-800-422-5346



# Friends



■ 41106



■ 41105



■ 41104



■ 41106



■ 41105



■ 41104



■ 41103



LEGO.com/popstar



**LEGO**

**Friends**



41105

7-12

LEGO.com/popstar



[LEGO.com/popstar](http://LEGO.com/popstar)



Friends

Apple, the Apple logo and iPad are trademarks of Apple Inc. Google Play is a trademark of Google Inc.





# Friends

■ 41101



■ 41100



■ 41098

# WIN

GO TO [WWW.LEGO.COM/PRODUCTFEEDBACK](http://www.LEGO.COM/PRODUCTFEEDBACK) AND  
GIVE US YOUR SHORT **FEEDBACK** ABOUT THIS  
LEGO® SET FOR A CHANCE TO WIN  
A COOL LEGO PRIZE.



## LEGO.com/productfeedback

### GEWINNE



Erzähle uns auf  
[www.LEGO.com/productfeedback](http://www.LEGO.com/productfeedback)

etwas über die Erfahrungen, die du mit  
diesem LEGO® Set gemacht hast, und  
sichere dir die Chance auf einen coolen  
LEGO Preis!

### GAGNE



Rends-toi sur  
[www.LEGO.com/productfeedback](http://www.LEGO.com/productfeedback)

et donne-nous quelques commentaires  
sur ce produit LEGO® pour avoir une  
chance de gagner un prix LEGO !

### GANAN



Visita  
[www.LEGO.com/productfeedback](http://www.LEGO.com/productfeedback)

y envíanos tu opinión acerca de este set  
LEGO®. ¡Participarás en el sorteo de un  
premio LEGO!

### 获取奖品



登录  
[www.LEGO.com/productfeedback](http://www.LEGO.com/productfeedback)

给出关于此乐高®套装的简短反馈，  
就有机会获得炫酷乐高奖品