



JUNIORS



10674



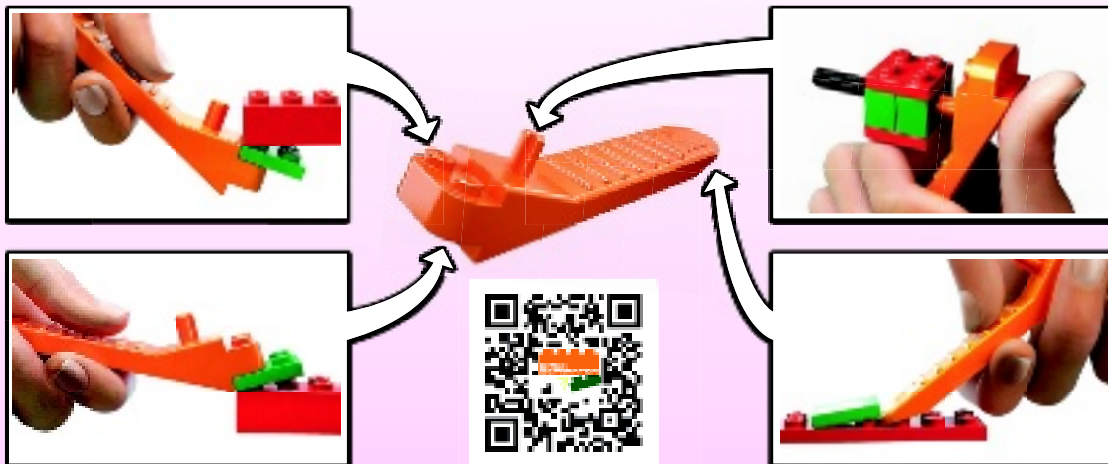

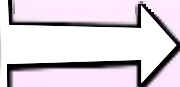

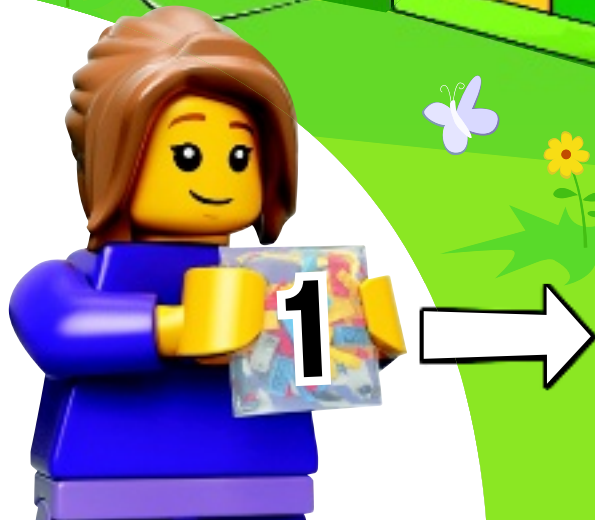

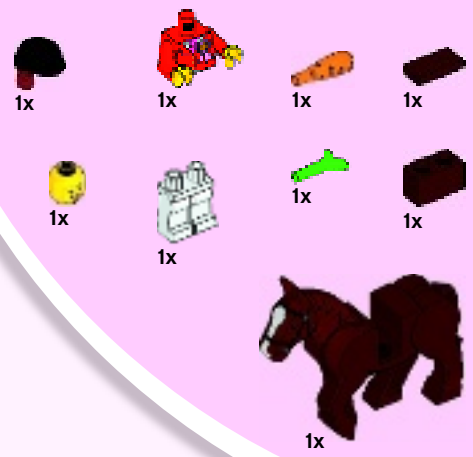
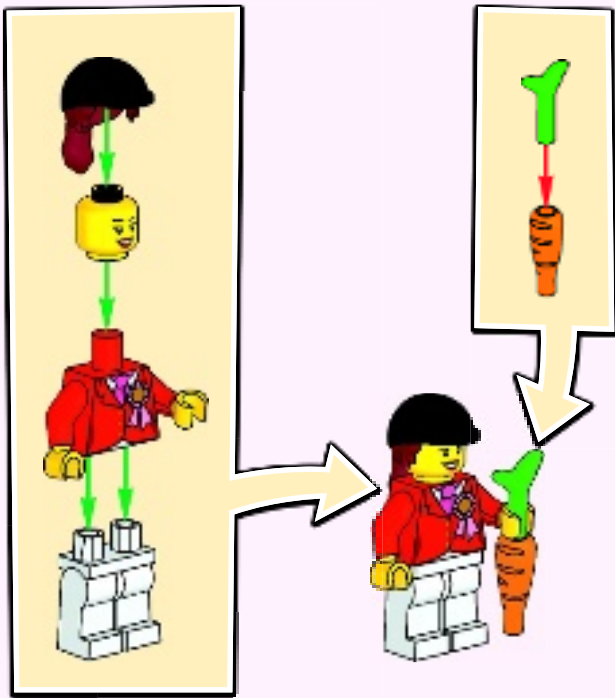

1



2



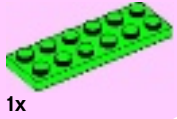
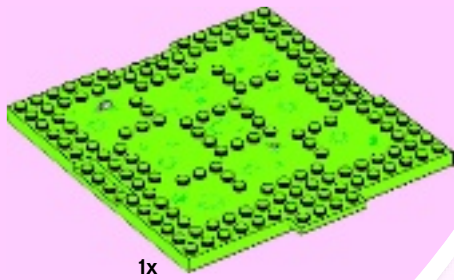

1

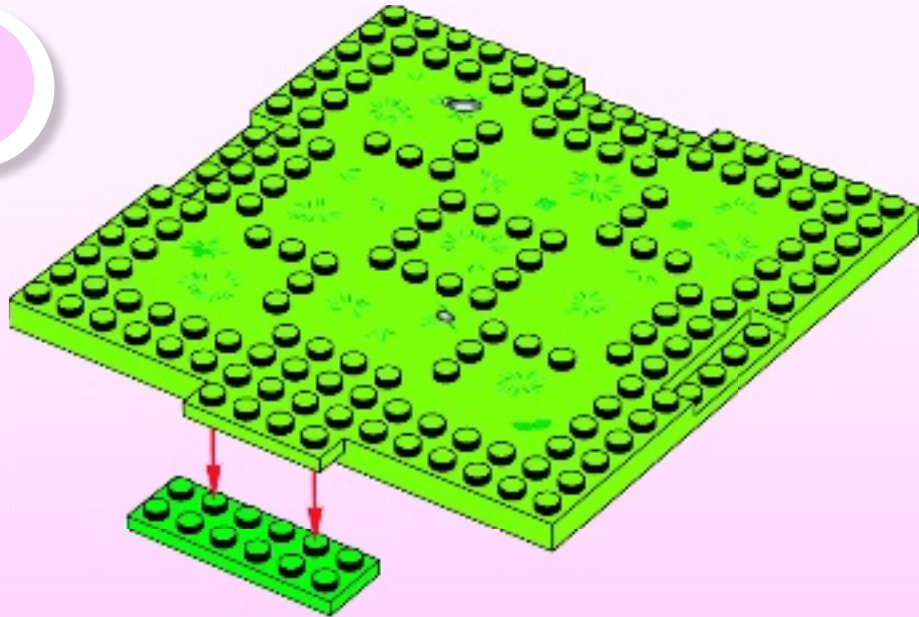

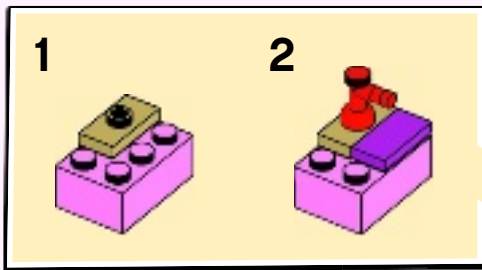

2

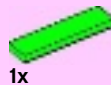
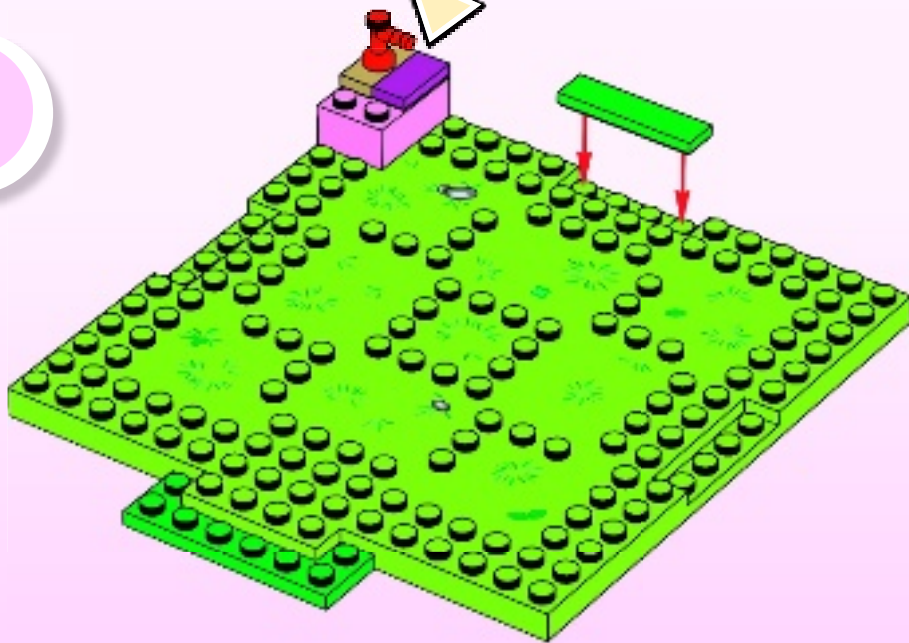

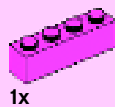

3

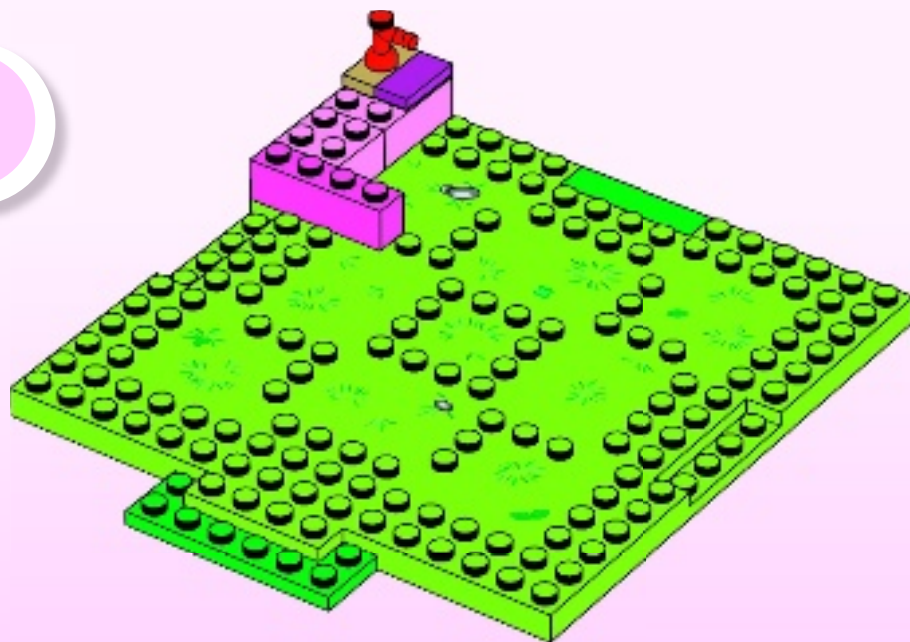

4

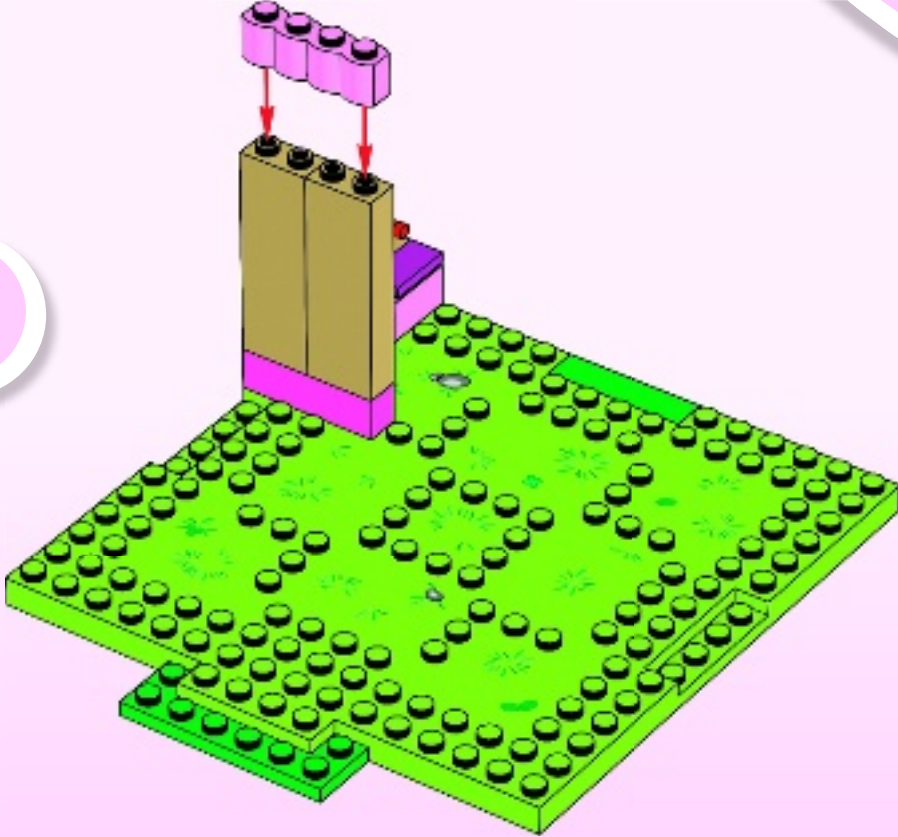

1x



2x

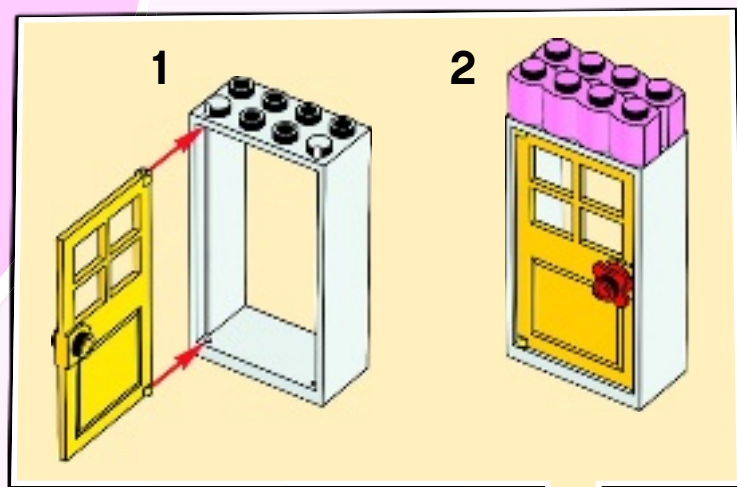
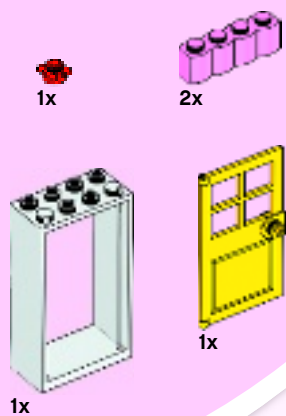

5



6

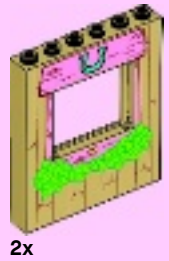
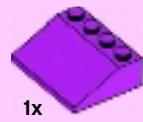
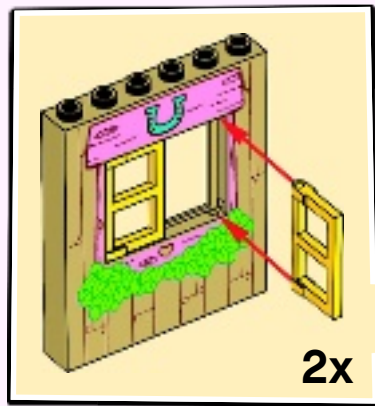

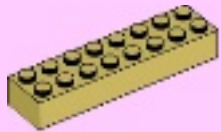

2x



7



8

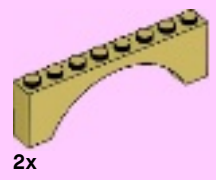

2x



1x



1x



1x



9



10



1x



1x



2x



1x



1x

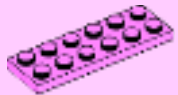

1x

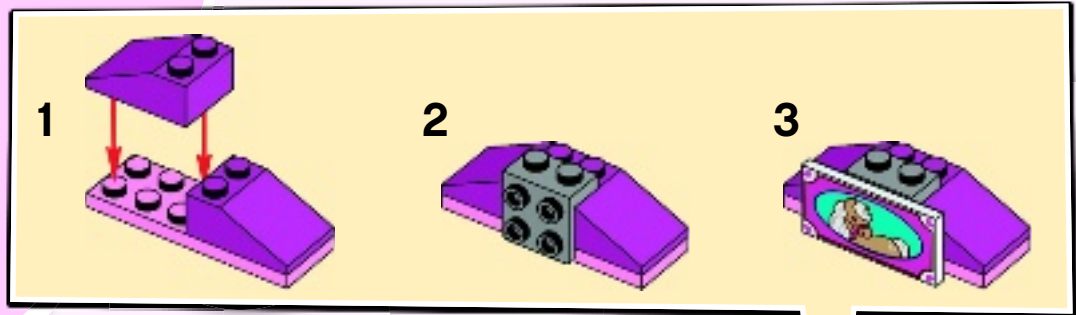

11





12



2x



1x



13



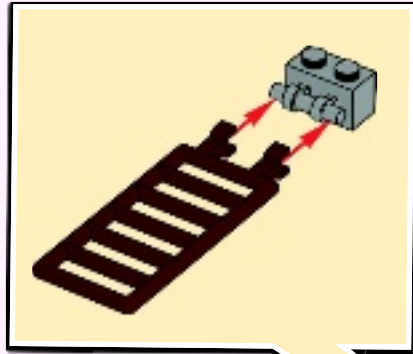

14



1x



1x



1x



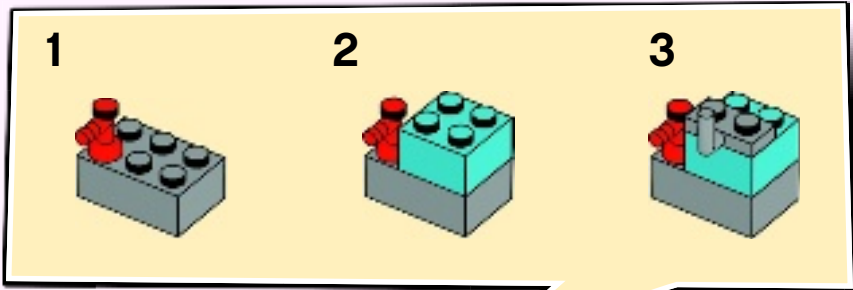

1x

1x

1x

1x

15

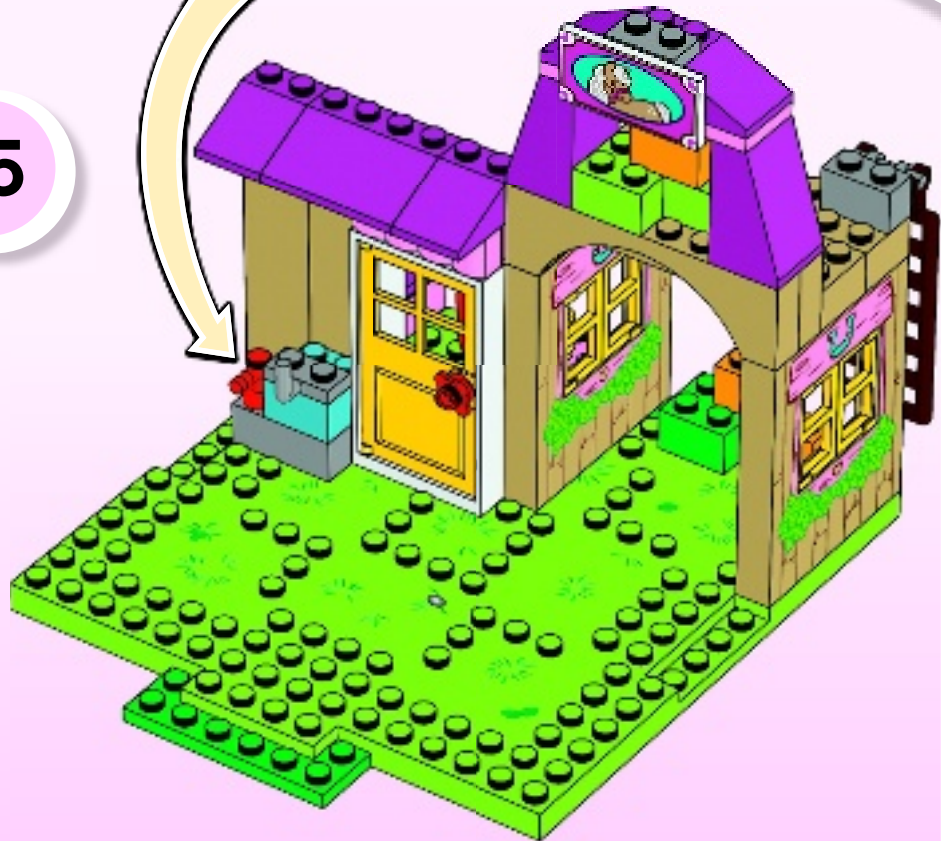



16





4x



5x

17





3x



3x



2x



2x



2x

18

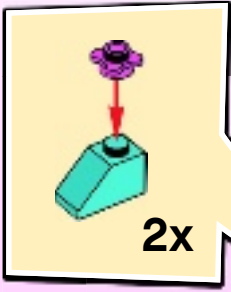

2x



1

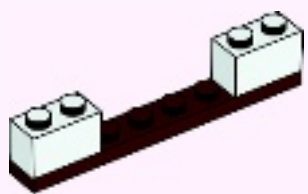

2

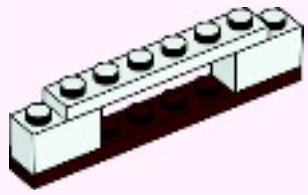

3

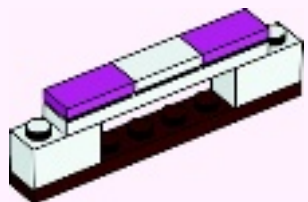

4

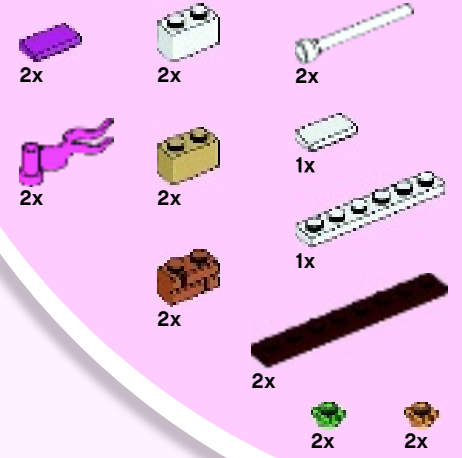
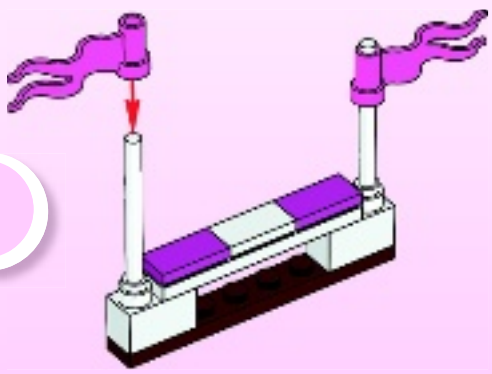

1

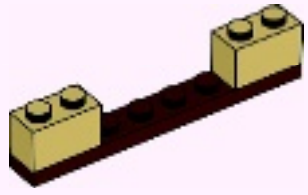

2

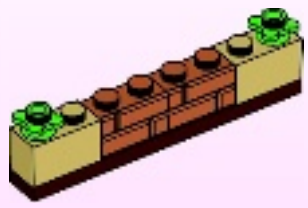

3







2x

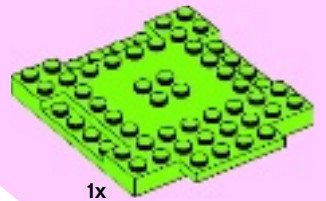

1x

19

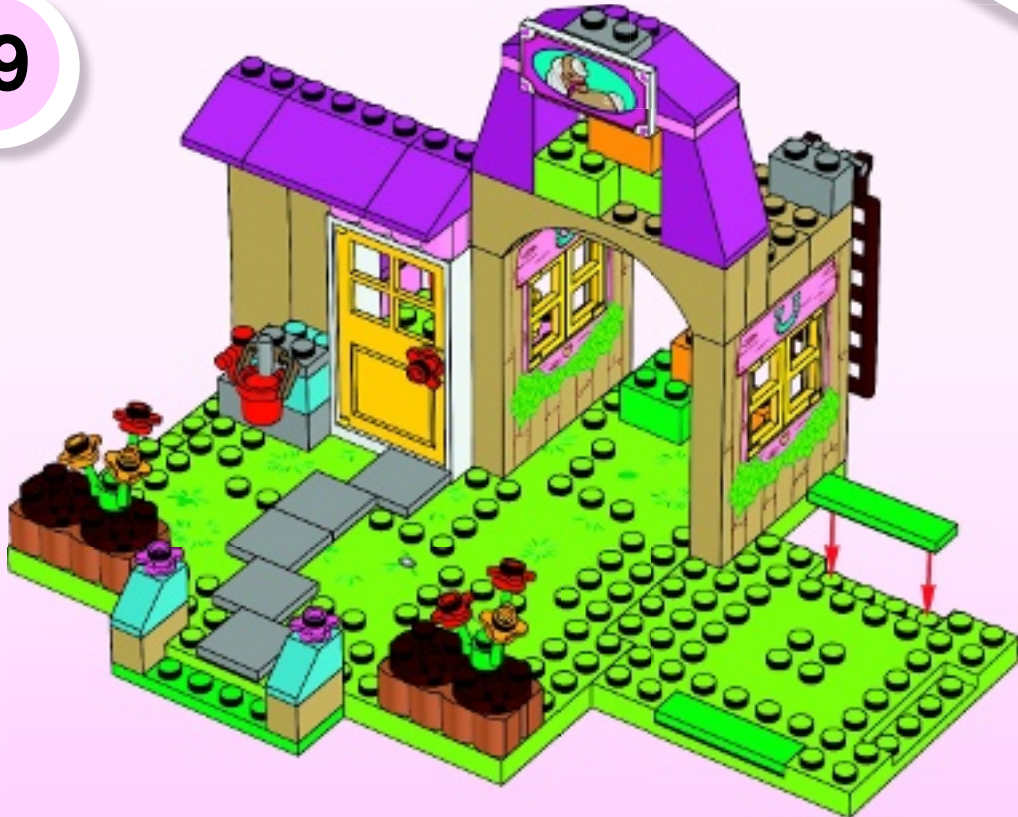



2x



1x



2x

20



1

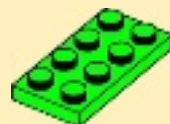

2



21



1x

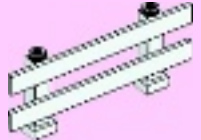

2x



1x

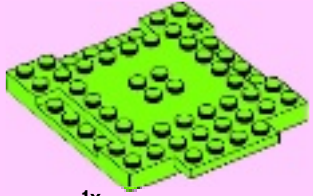

1x



22



23



2x



1x



1x





1x



2x



4x

24

1



2

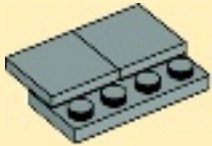

25

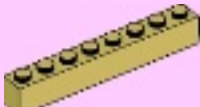

1x



1x

2x

2x

1x



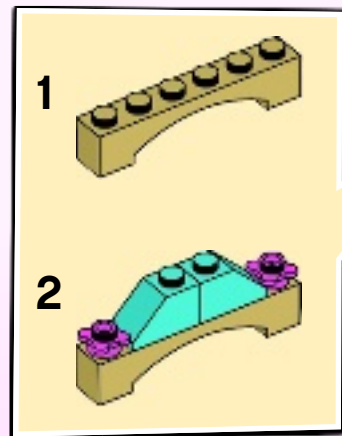

26

1

2



27

- 1x 
- 1x 
- 4x 
- 1x 

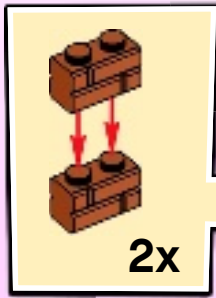



1x



1x



2x



1x



1x



3x



3x

28

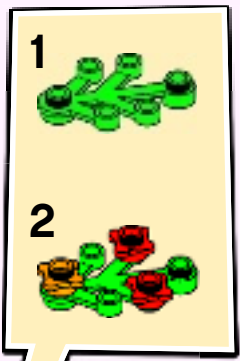
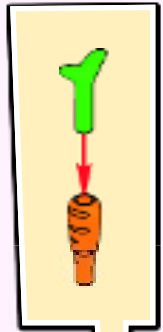



LEGO

JUNIORS



10674



10667



10673



10668



Ready for more? build and play

- Bereit für mehr? Bauen und Spielen
- Encore plus de jeu ? construis et joue
- ¿Estás preparado? ¡Más construcción y más juegos!
- Estás pronto para mais? constrói e brinca
- Készen állsz MÉG TÖBB építésre és játékra?

LEGO

Friends

5-12



LEGO JUNIORS

4-7



... with **LEGO® Friends**
in **Heartlake City**

LEGO.com/friends



Win!

Go to LEGO.com/productfeedback to fill out a survey for a chance to win a cool LEGO® Product.

No purchase necessary.
Open to all residents
where not prohibited.



LEGO.com/productfeedback

Gewinne!

Nimm an der Umfrage auf LEGO.com/productfeedback teil und hab die Chance ein cooles LEGO® Produkt zu gewinnen!

Die Teilnahme am Gewinnspiel führt zu keinerlei Kaufverpflichtungen. Teilnahme in allen nicht ausgeschlossenen Ländern möglich.

Win!

Ga naar LEGO.com/productfeedback, vul een enquêteformulier in en maak kans op een cool LEGO® product.

Geen aankoopverplichting. Ledereen mag deelnemen, uitzonderend ingezetenden van landen waar een enquêteverbod geldt.

Gagne!

Visite LEGO.com/productfeedback pour répondre à un questionnaire et avoir une chance de gagner un produit LEGO® très cool!

Aucune obligation d'achat. Ouvert à tous les résidents des pays autorisés.

当てよう!

LEGO.com/productfeedbackにアクセスして、アンケートにご記入ください。当選者にはレゴ製品を差し上げます。

お買い上げの必要はありません。

禁止されていない限り、すべての皆様にご利用いただけます。



JUNIORS

10674



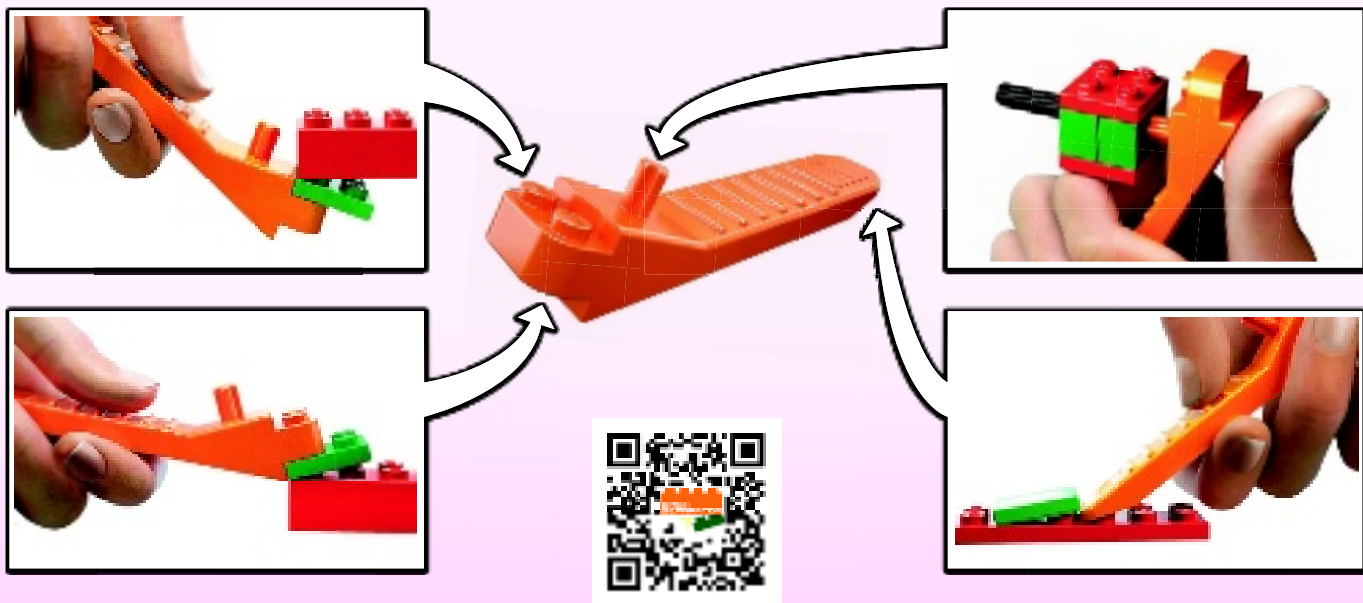



Build & Rebuild

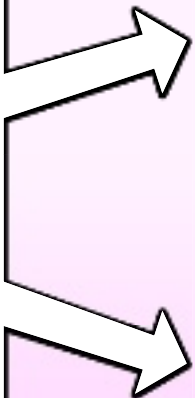



Build & Rebuild

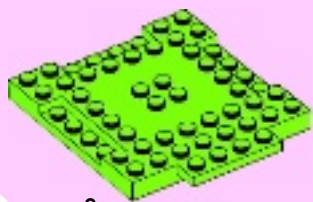
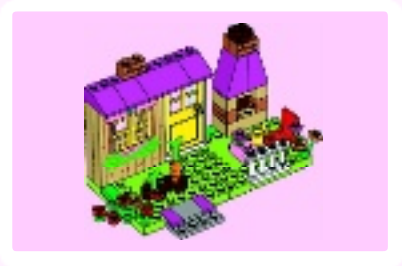

2x

1

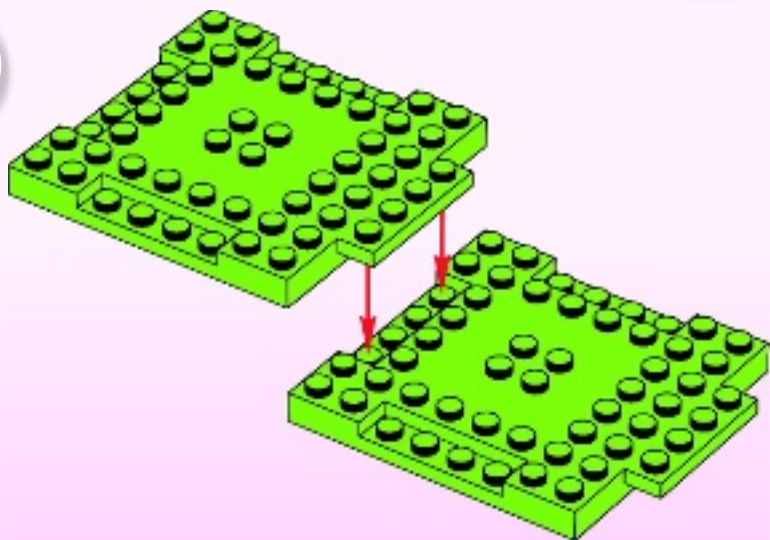



3x

2

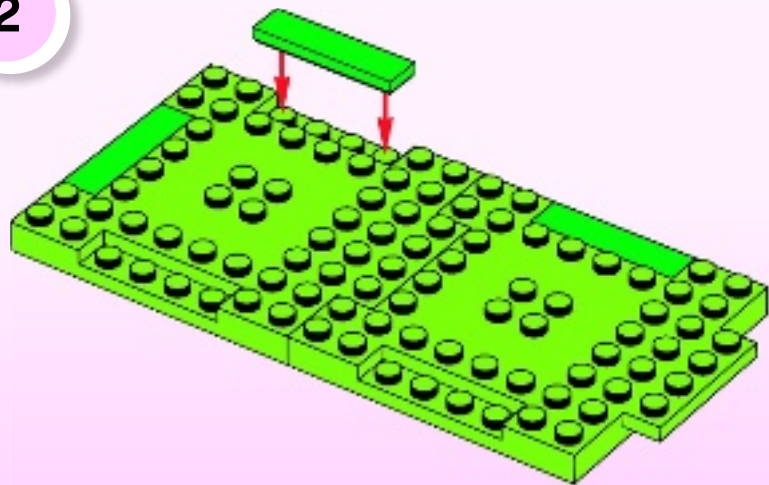

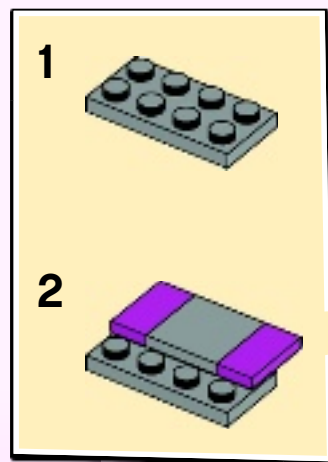

3

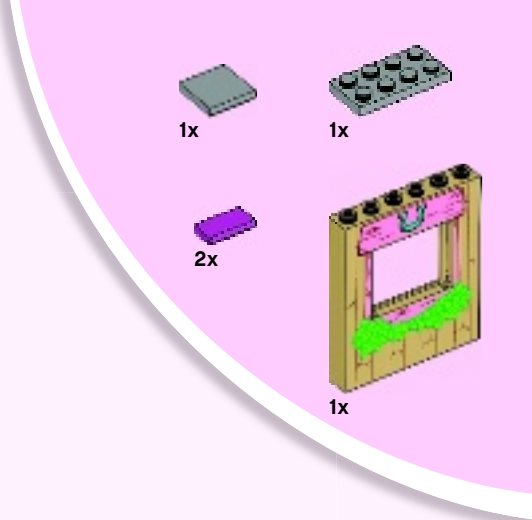
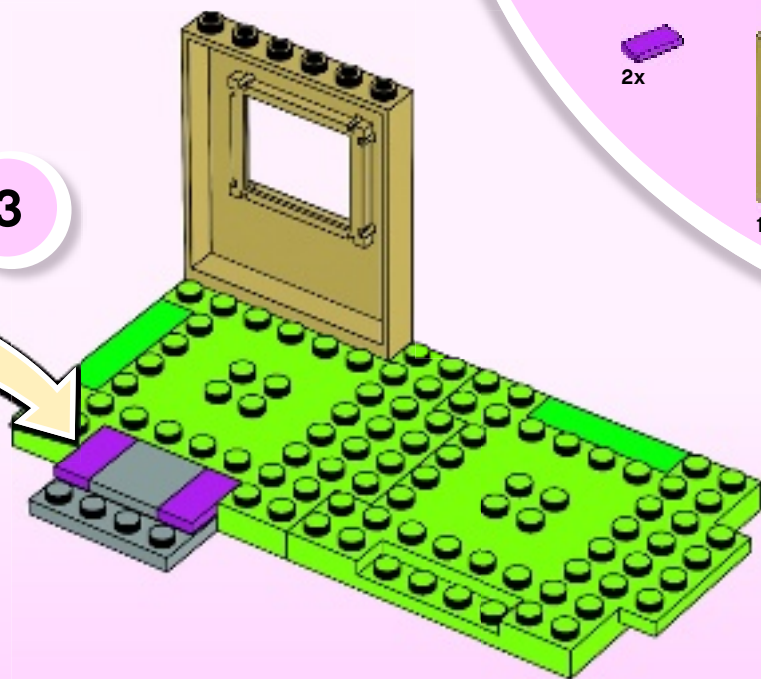

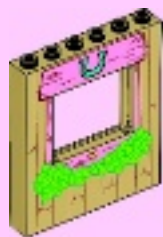

1x



2x

4

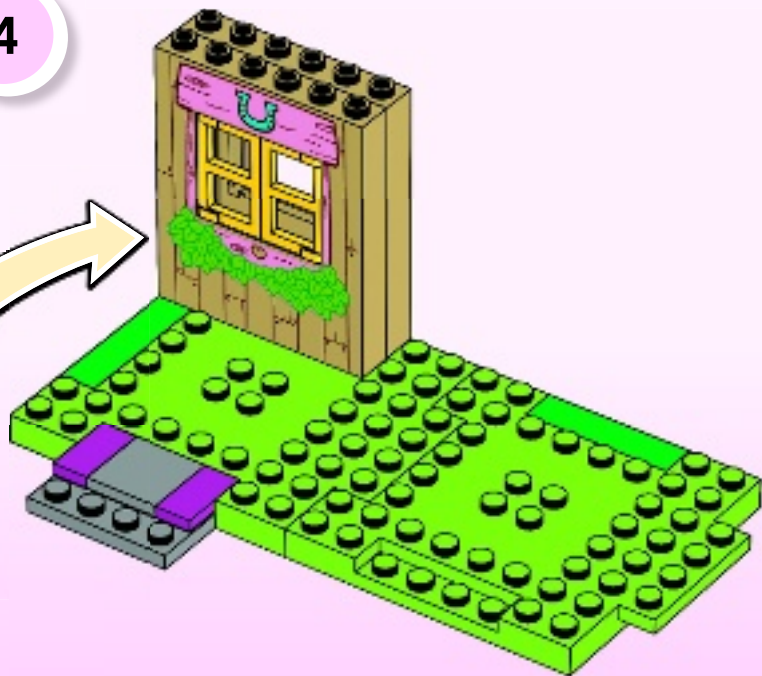
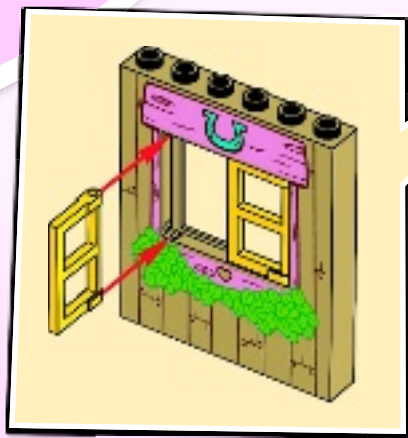

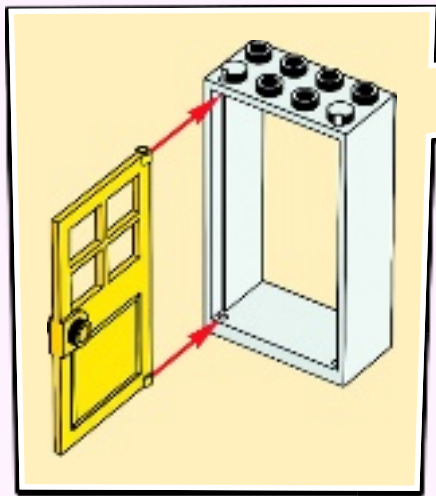

5

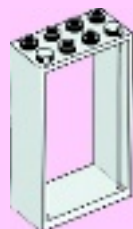



3x



1x

6

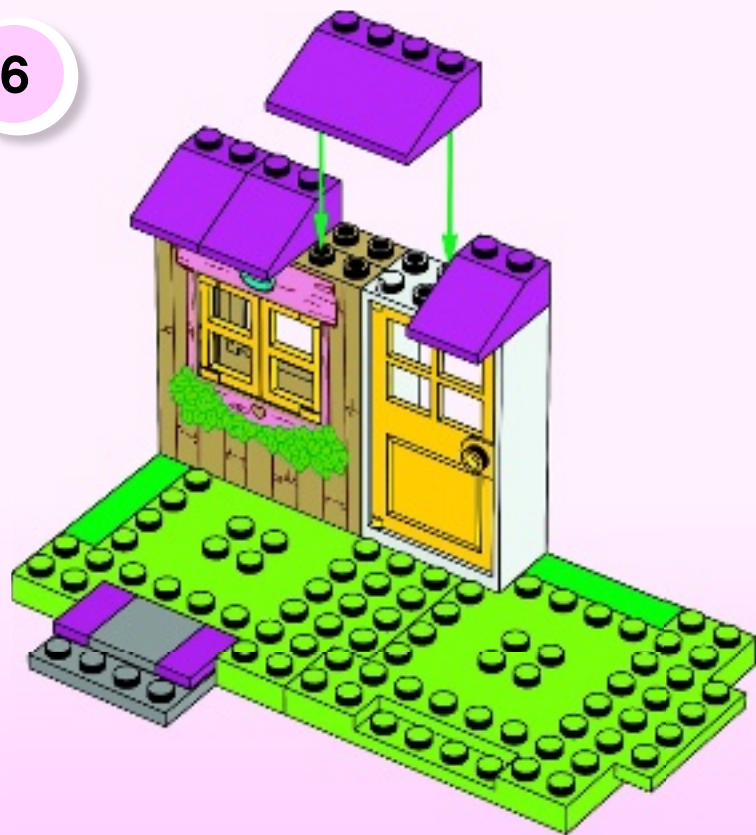

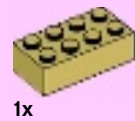

1

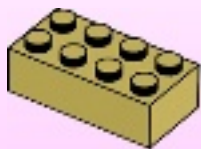

2

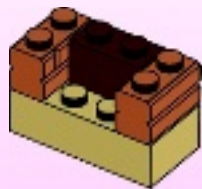

3

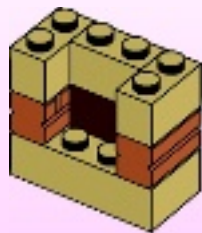



1x



2x



2x



4

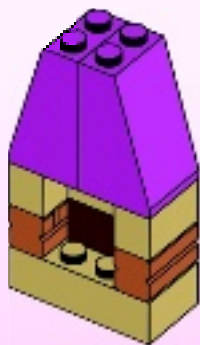

5

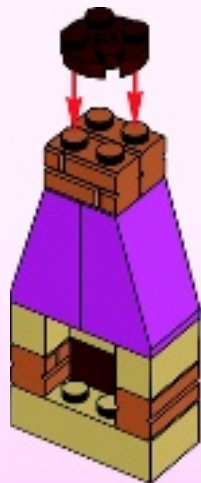

7

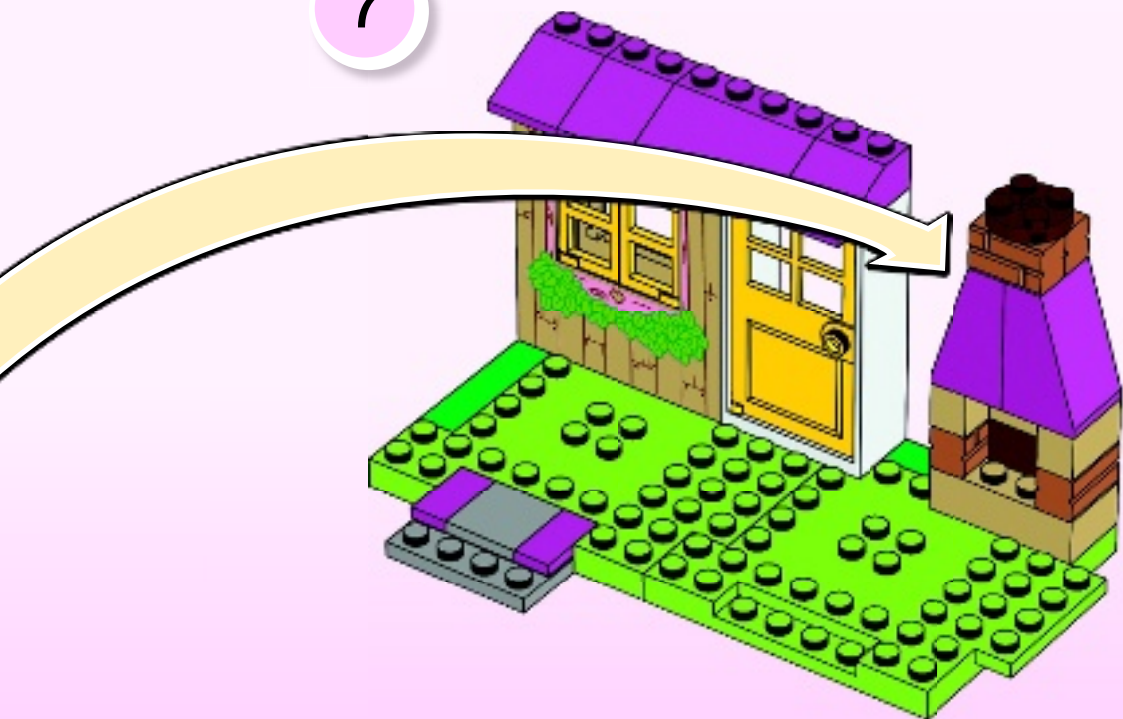

3x

2x

1x

8

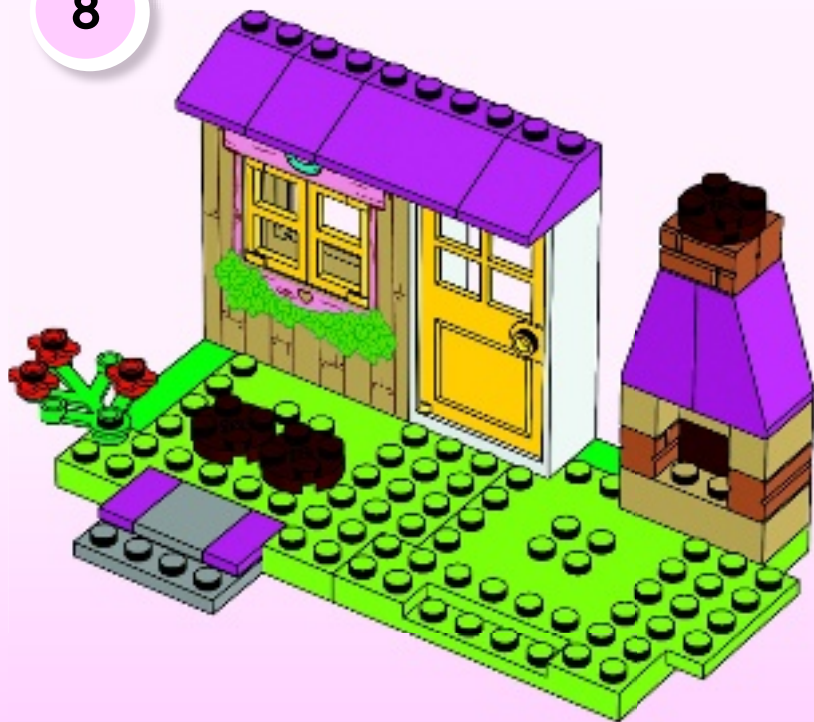

1



2



9

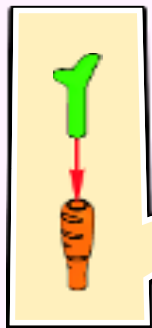

1x



2x



1x

1x



1x



1x



1x



1x



10

1



2

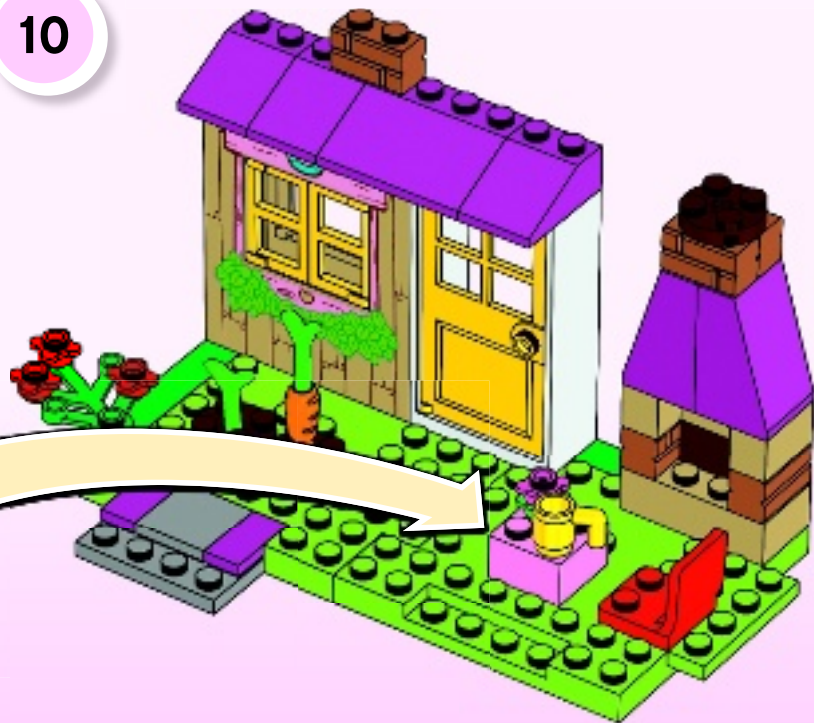

11



3x

2x

1x

2x



1x



Build & Rebuild

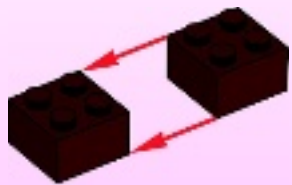

1



2

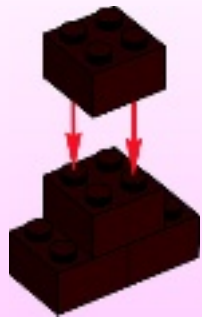

3

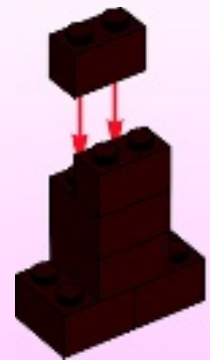



1x



2x



2x



2x



2x



2x



1

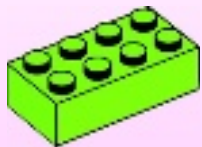

2

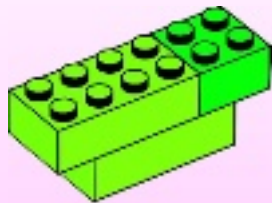

3

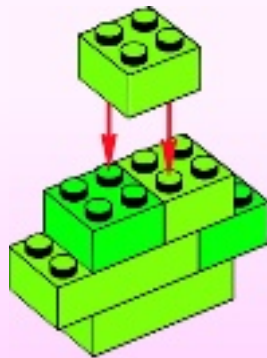

4

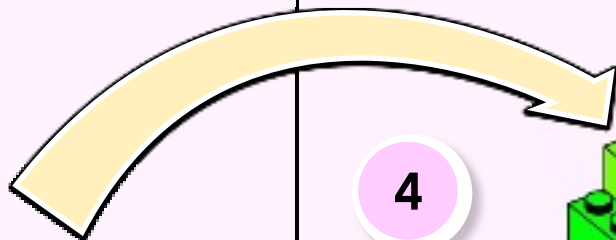
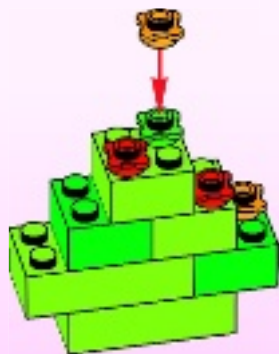

4

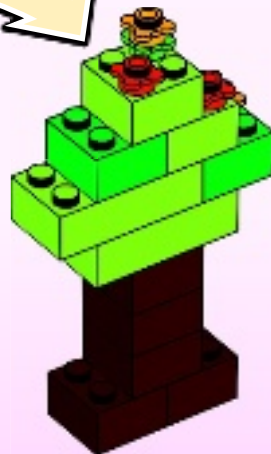



5

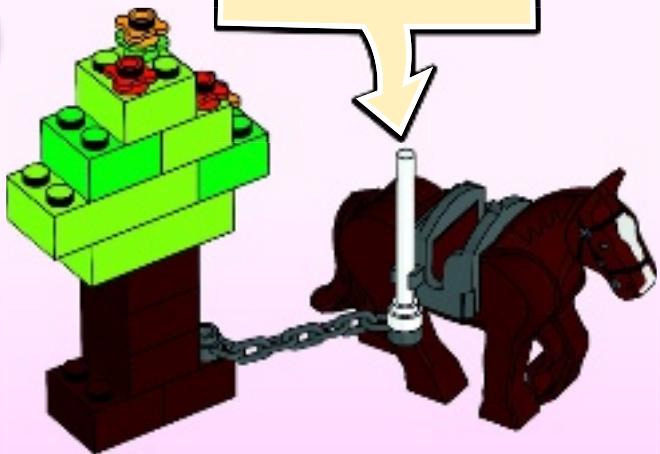
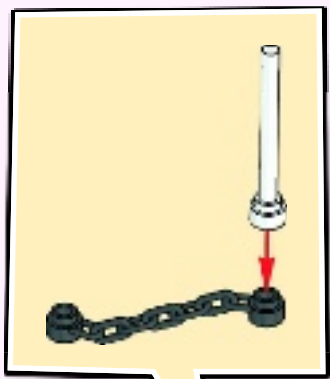



6

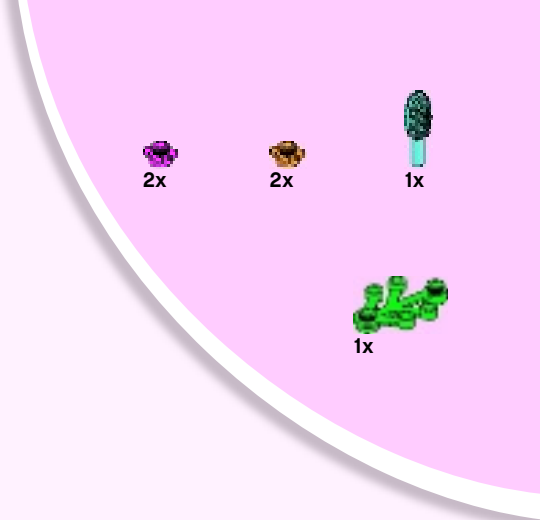
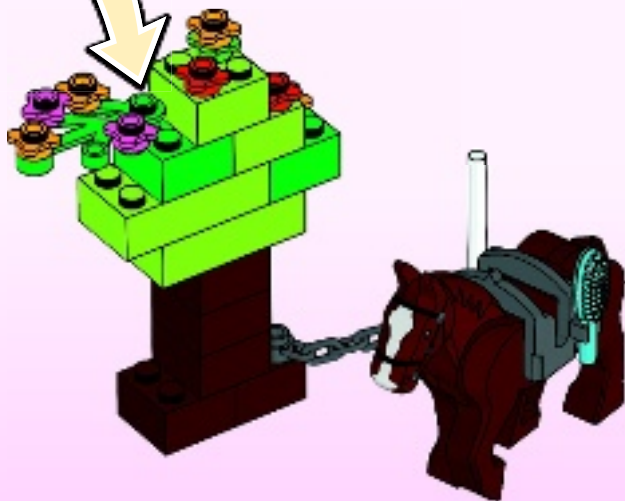

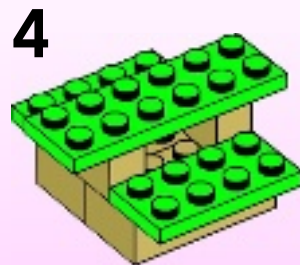
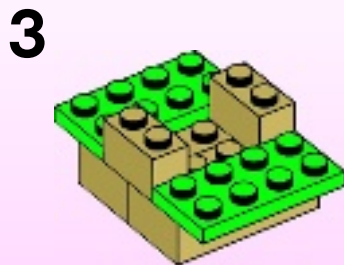
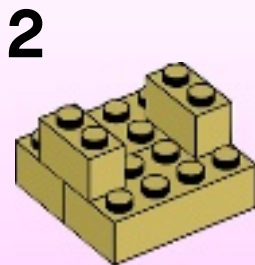
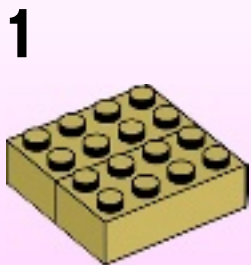
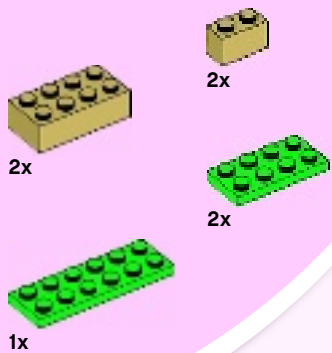

7



- 1x 
- 1x 
- 1x 



4x
300401



8x
300301



2x
300201



6x
300101



4x
4117061



1x
306901



1x
6057639



1x
366601



1x
4528140



1x
6047813



2x
4541808



2x
395701



1x
9327



16x
4109995



2x
4114064



12x
4114306



6x
4114319



1x
4159774



2x
6037398



1x
4618876



2x
6079724



1x
4155708

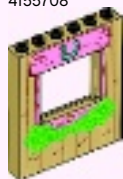

2x
6057711



1x
4626884



1x
6003001



7x
6035617



2x
459921



1x
407921



1x
6057730



2x
389924



4x
300424



10x
300324



1x
300224



6x
300124



4x
4528136



1x
4528550



1x
4651443



4x
4107736



7x
300328



3x
243128



2x
302028



1x
379528



2x
4619599



2x
374128



2x
242328



2x
4119479



2x
4243677



1x
6035584



4x
4216479



6x
4517992



3x
4621542



1x
6016664



2x
4119478



1x
4654448



8x
4624184



6x
6003003



3x
4611415



2x
6058361



4x
4599547



1x
4599548



1x
6058368



1x
4653970



4x
4619655



1x
4211580



4x
4211159



3x
4211149



4x
4211210



1x
4211157



1x
6030812



2x
4216945



1x
6022359



1x
4211580



1x
4211386



9x
4211413



1x
4211445



1x
4211395



1x
4611702



1x
6009014



7x
4164022



13x
4220632



4x
4220631



6x
4165967

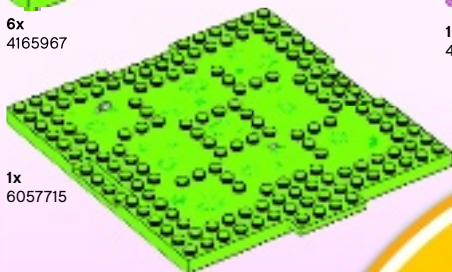

1x
6057715



2x
6055164



1x
4267282



1x
4211006



1x
4600437



5x
4518892



3x
4649743



6x
4520632



1x
4625633



8x
4517993



9x
4550359



6x
4656783



4x
4651232



Customer Service

Kundenservice

Service Consommateurs

Servicio Al Consumidor

LEGO.com/service or dial



: 00800 5346 5555

: 1-800-422-5346



LEGO.com/Juniors



App



Games



Find more building instructions
online



6072719

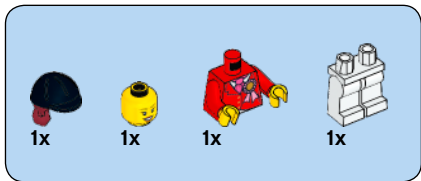
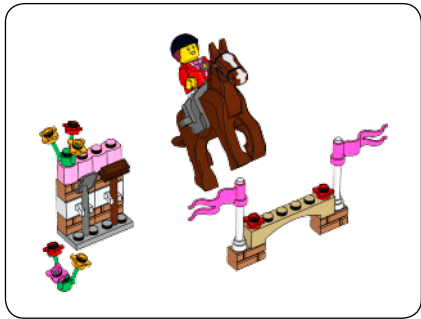

1

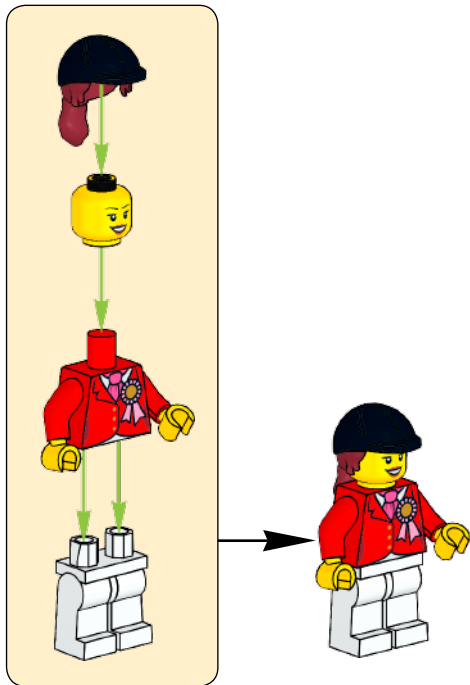

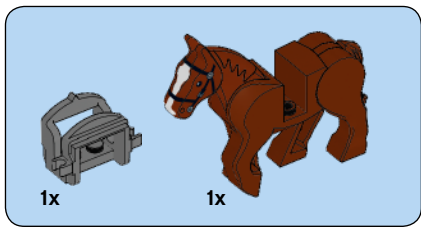

2

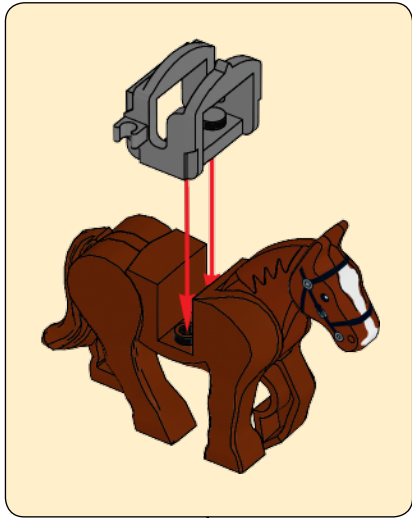

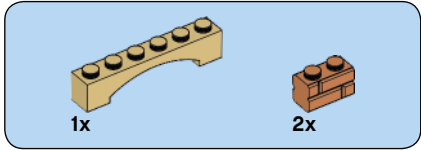
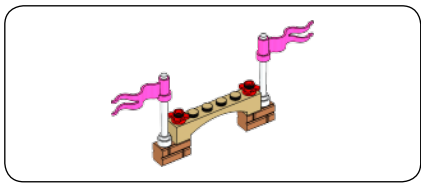

1

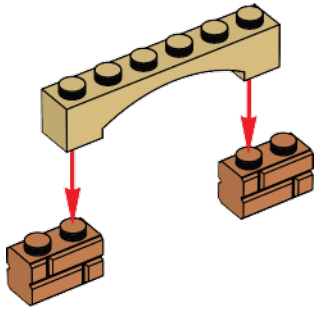

2

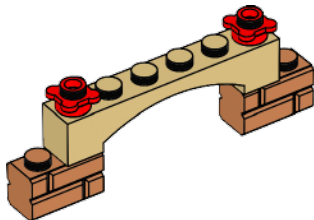

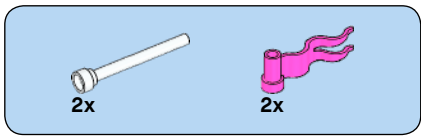

3

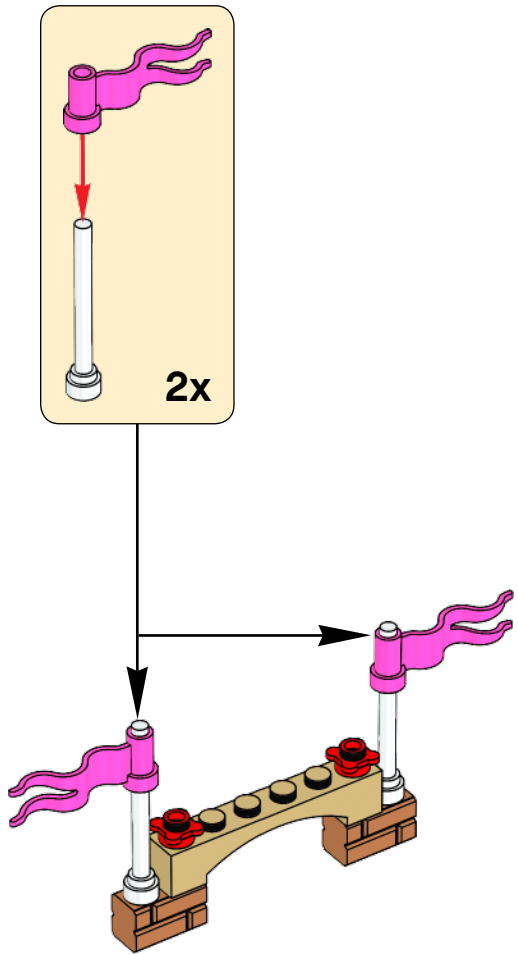

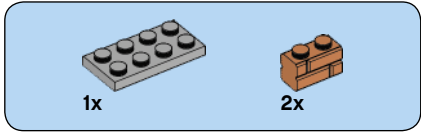
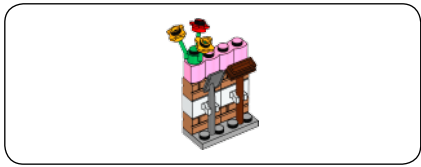

1

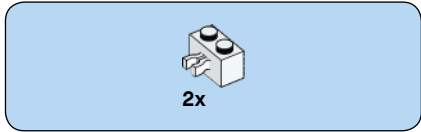
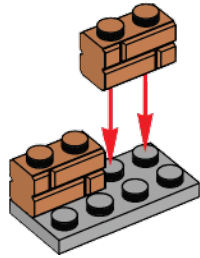

2

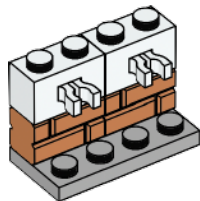

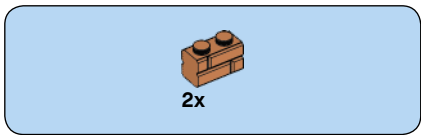

3

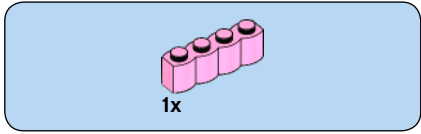
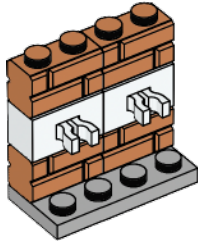

4

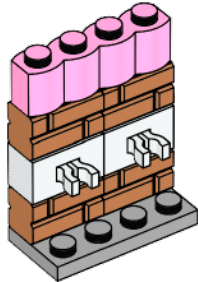

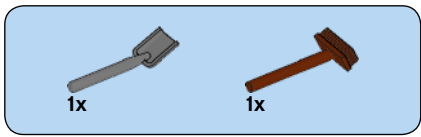



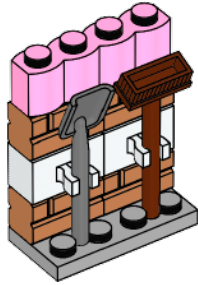

5

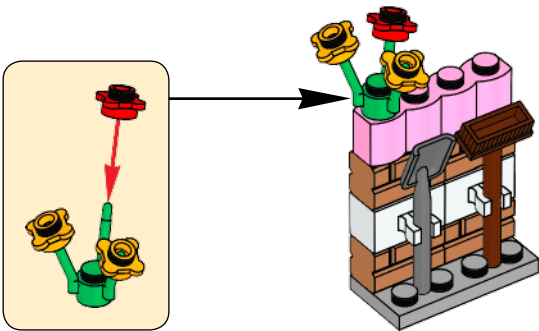

6



- 1x 
- 1x 
- 1x 
- 1x 

7

