



# MARVEL SUPER HEROES



76051



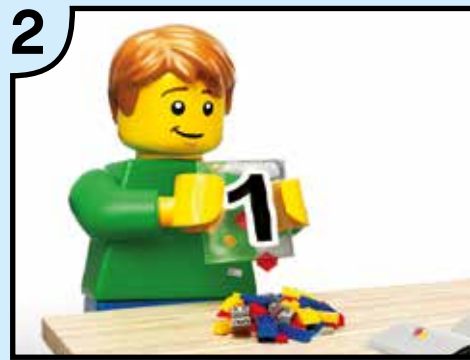

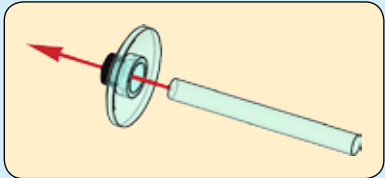
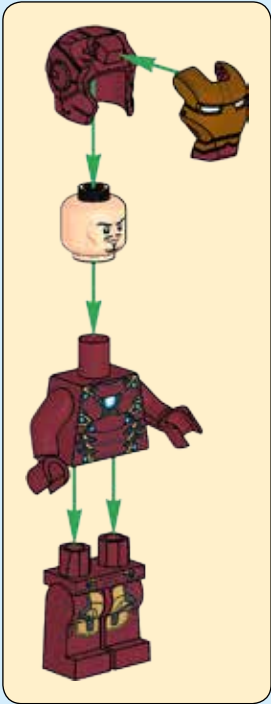



1x

1

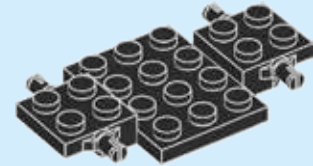
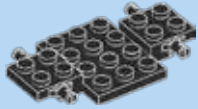

1x

2

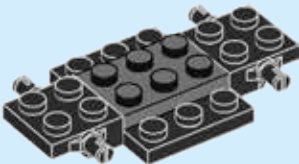

4



1x



1x

3

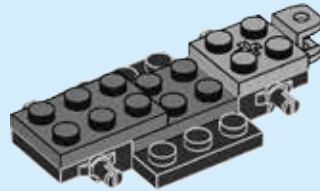

2x

4

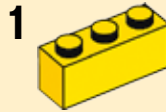
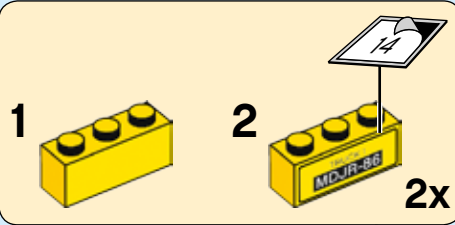

1

2



2x





2x

5

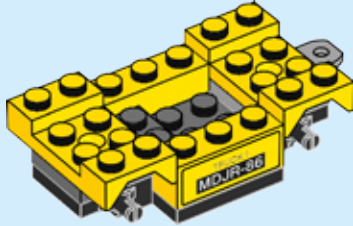

1x



2x

6

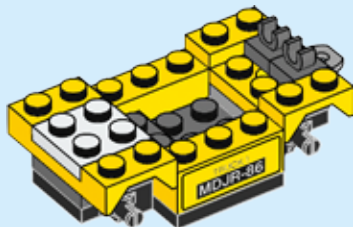

1x



2x

7

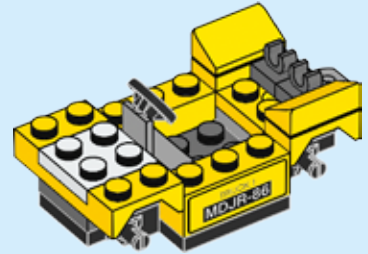

2x



2x

8



2x

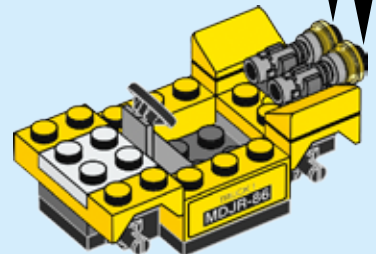

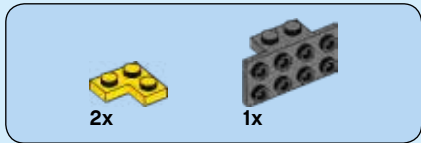

9

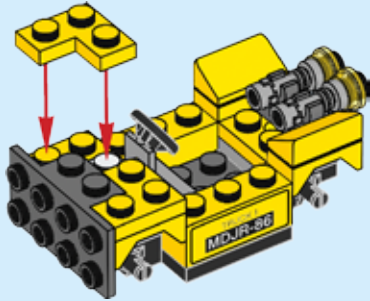

10

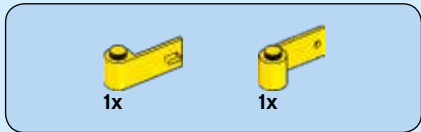
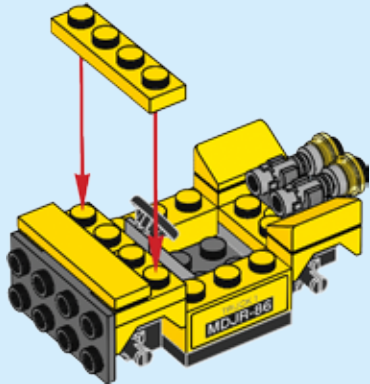

11

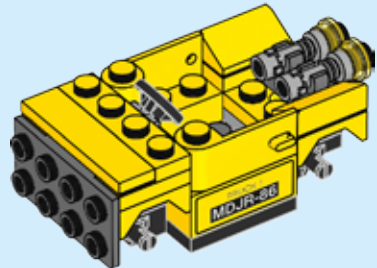

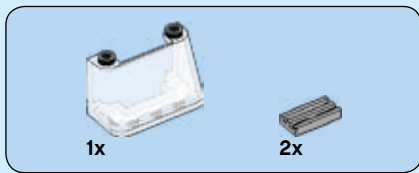

# 12

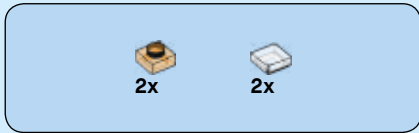
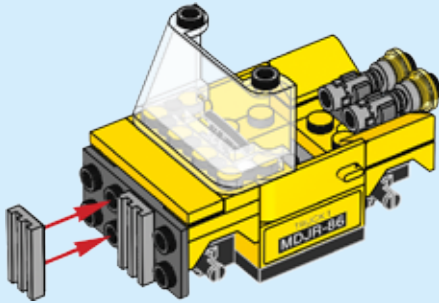

# 13

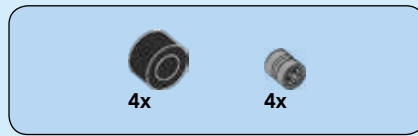
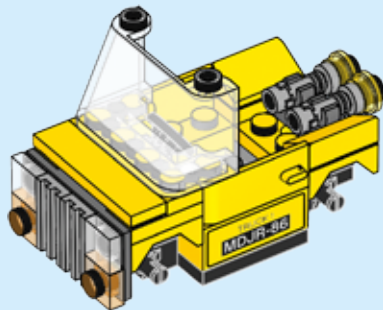

# 14

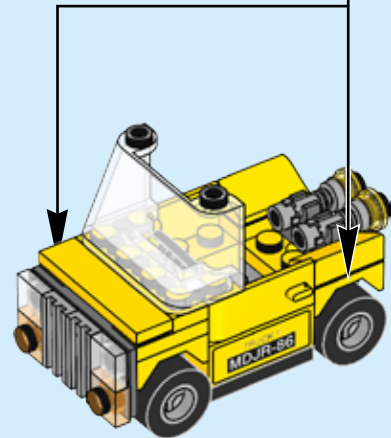
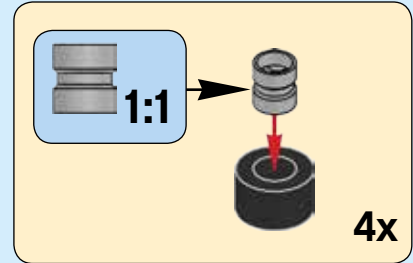



15

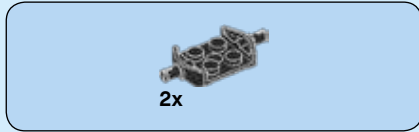
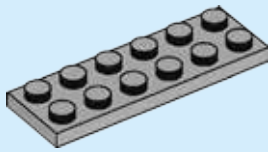

16

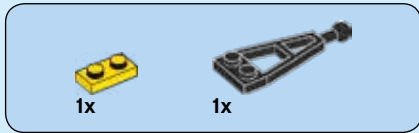
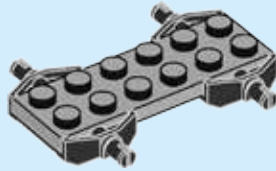

17

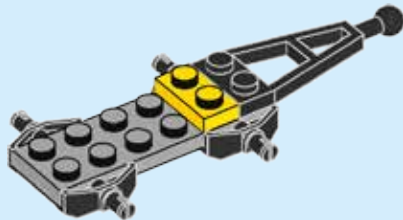





# 18

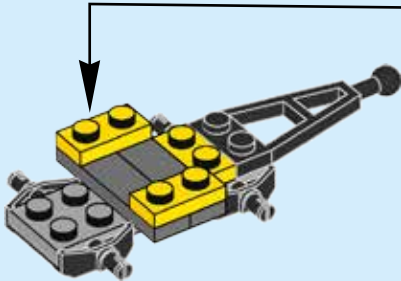
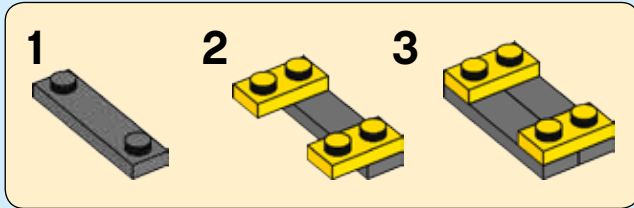

# 19

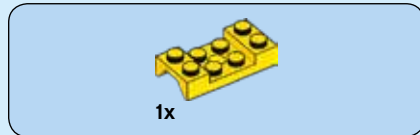
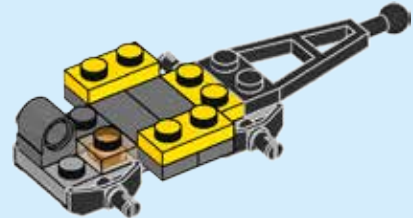

# 20

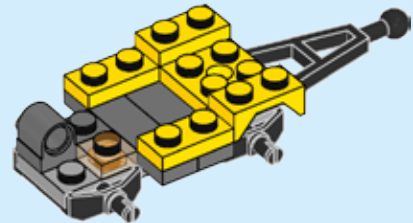



1x

# 21

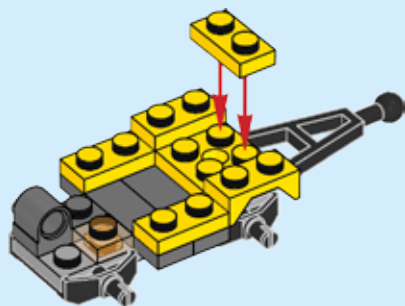

1x



2x

# 22

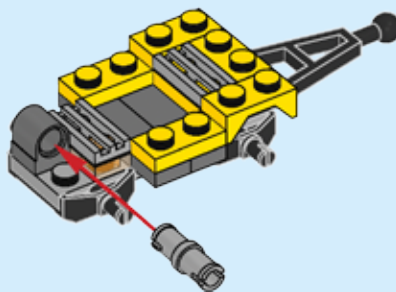

2x

# 23

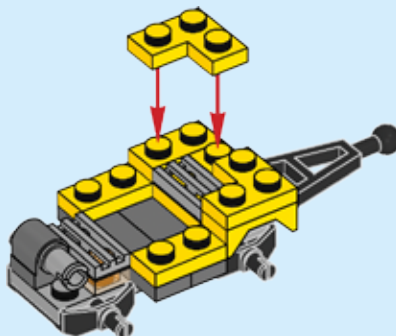



2x



1x

# 24

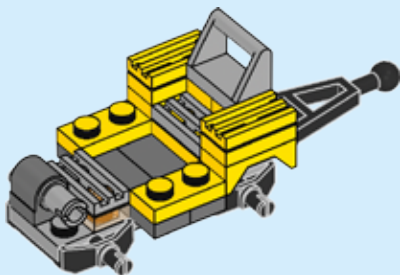

1x

# 25

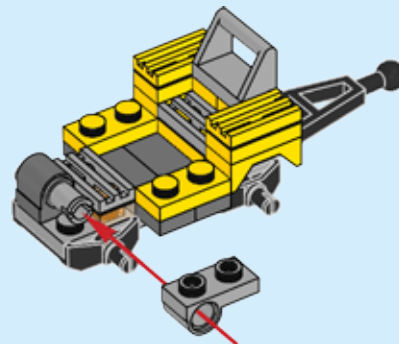

2x

# 26

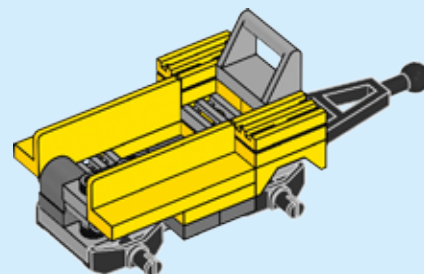

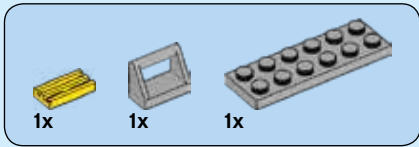

# 27

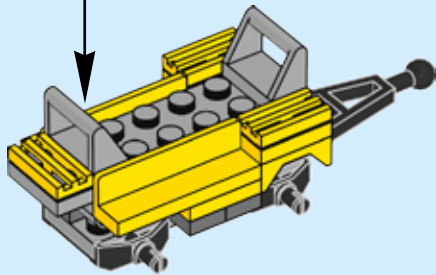
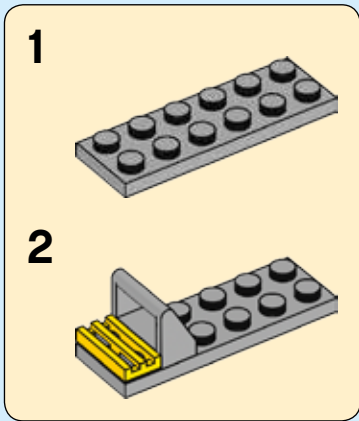

# 28

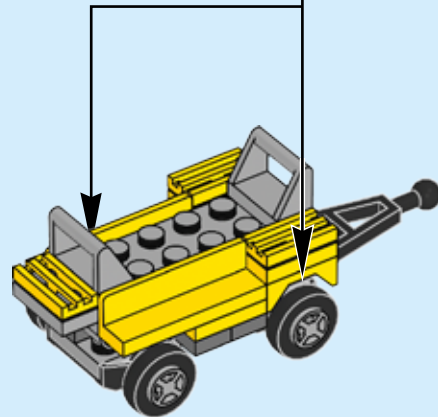
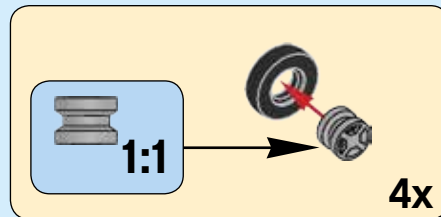



# 29

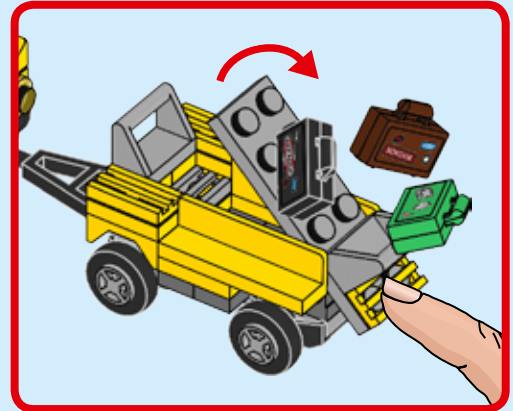
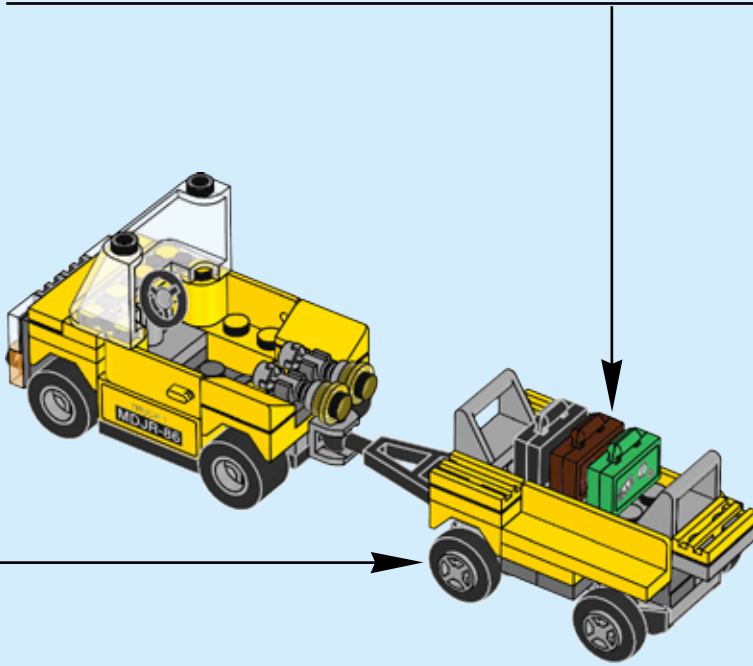
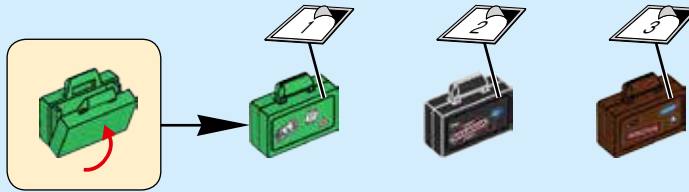

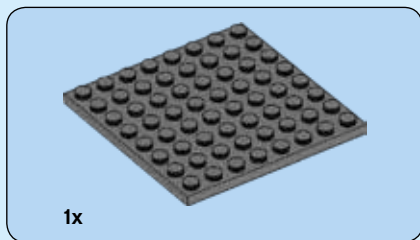
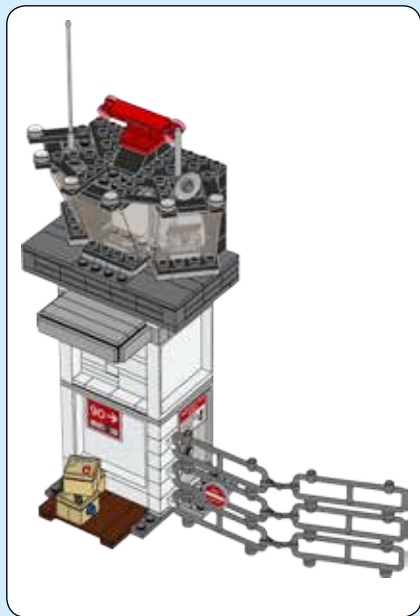

**1**

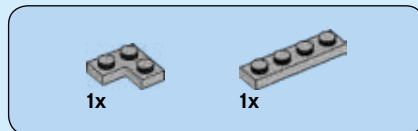
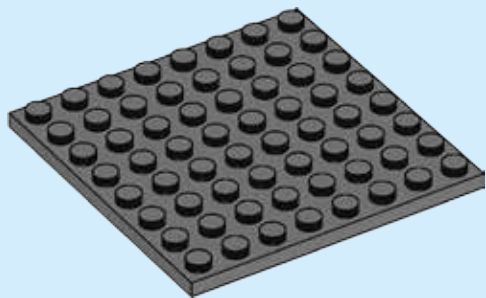

**2**

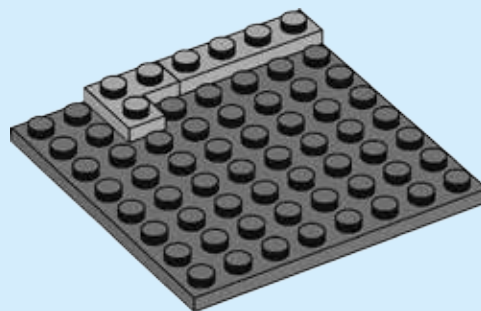

**3**

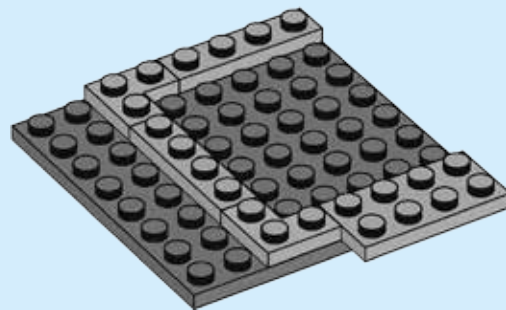

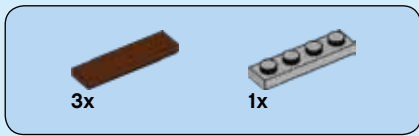

4

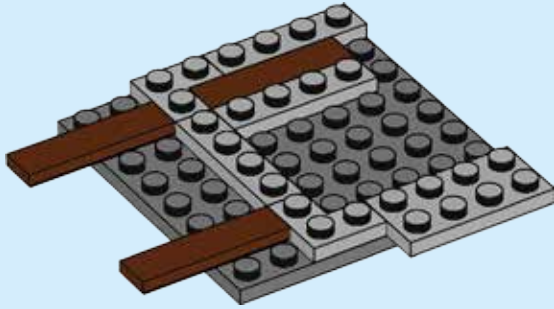

5

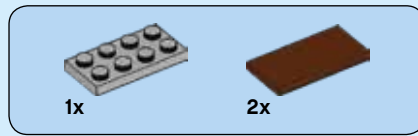
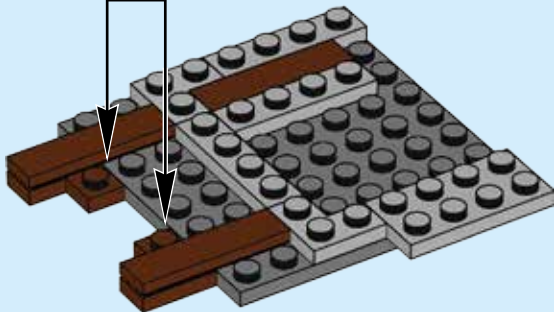

6

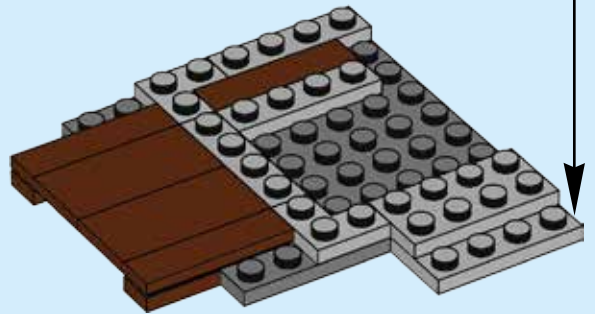
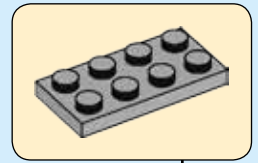

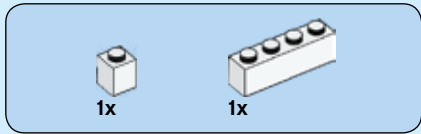

7

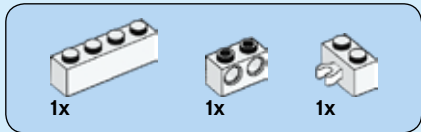
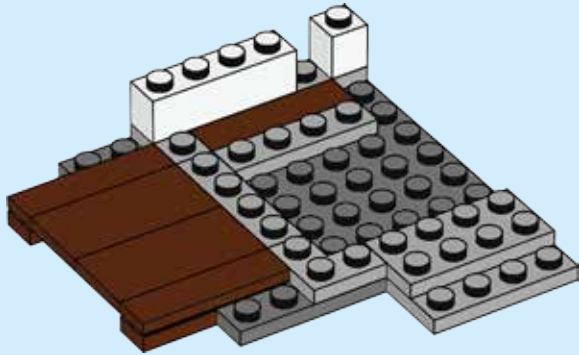

8

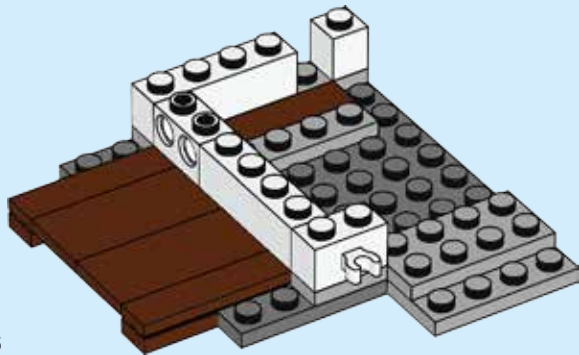

9

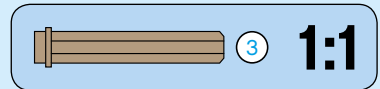
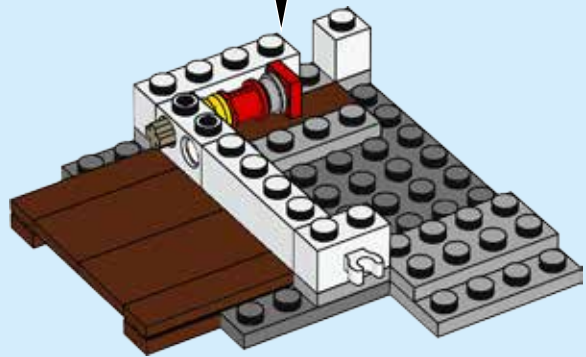
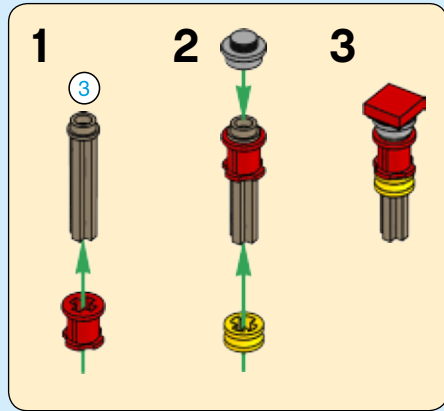

1:1



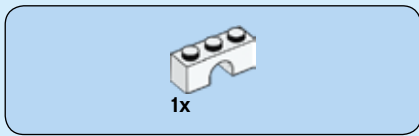

# 10

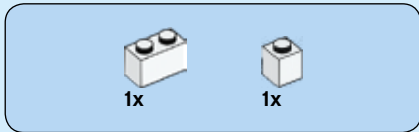
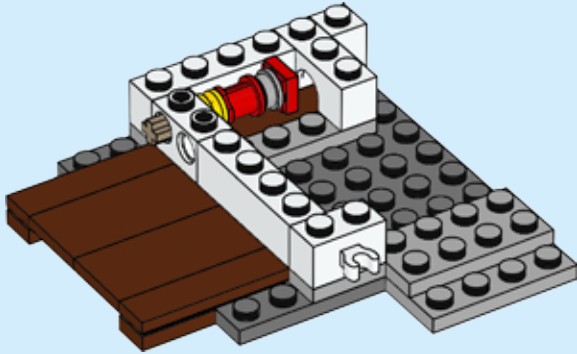

# 11

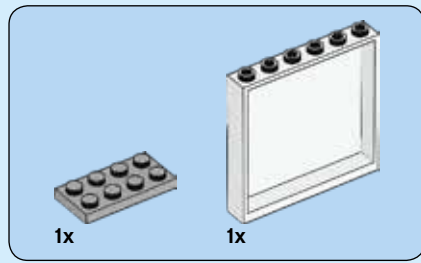
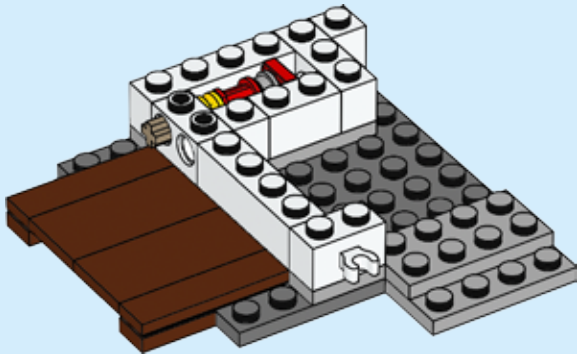

# 12

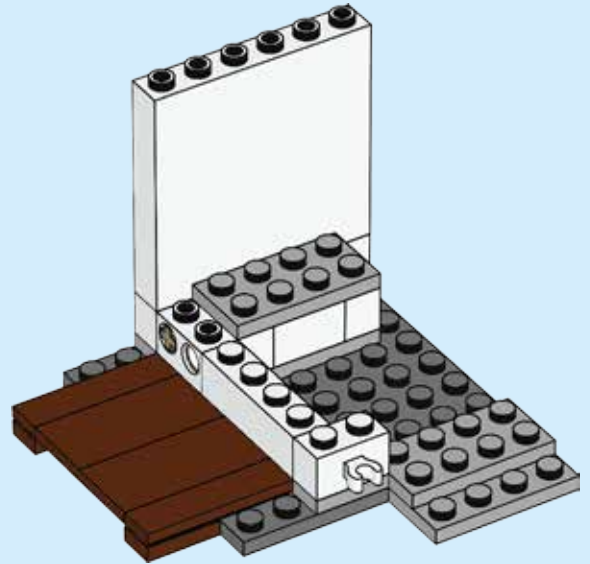

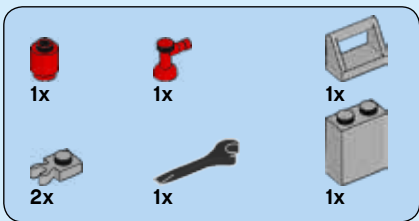

# 13

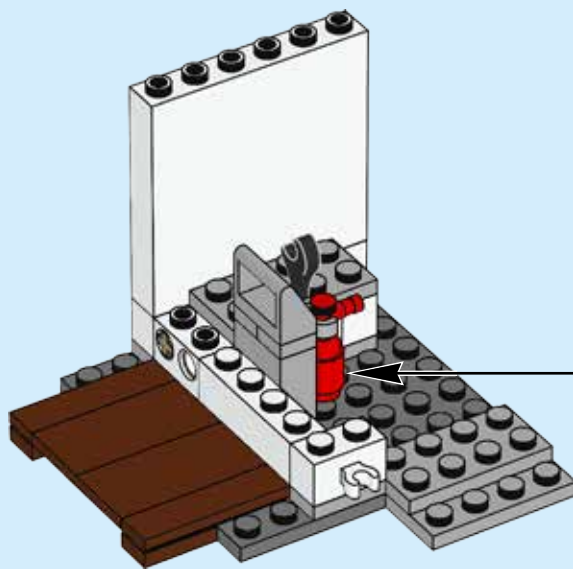
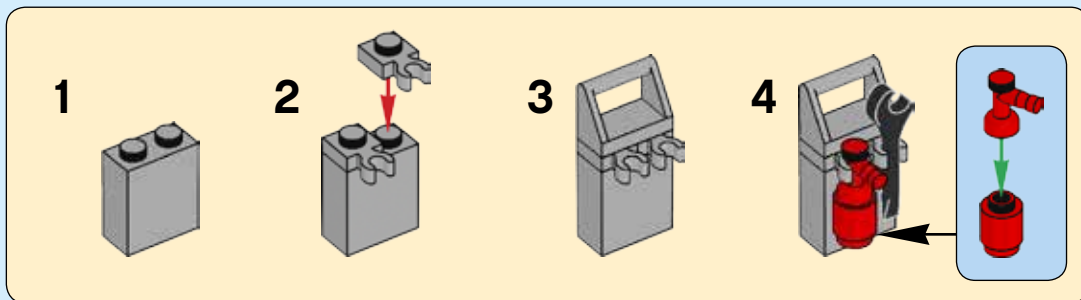

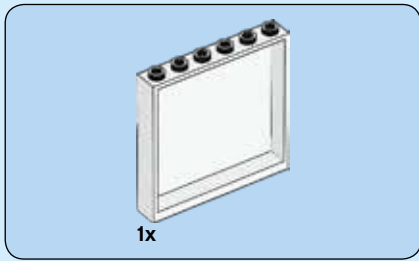

14

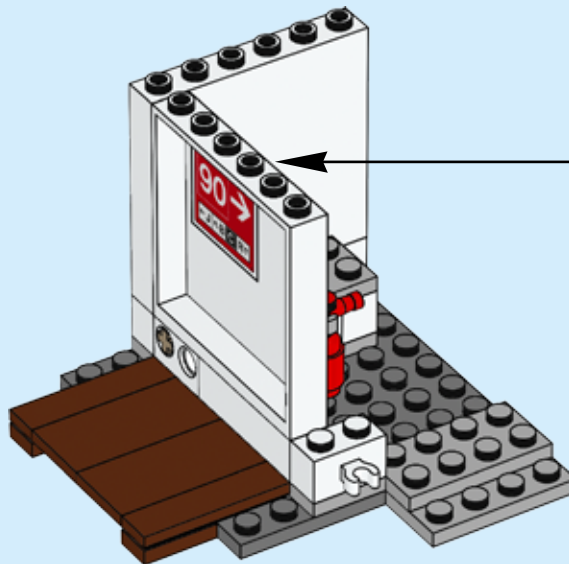
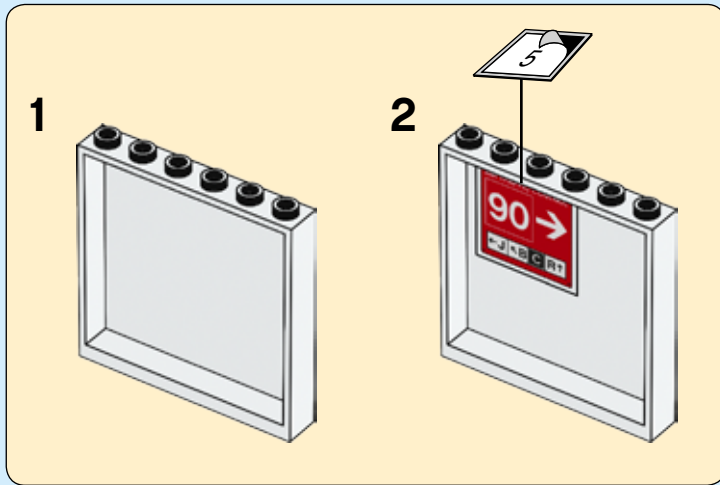



3x



2x

# 15

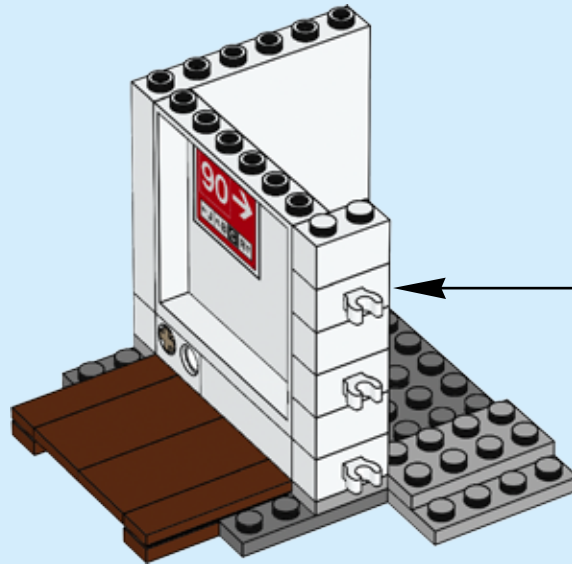
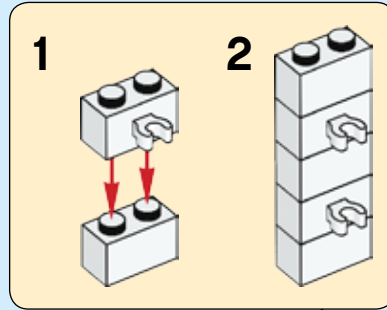

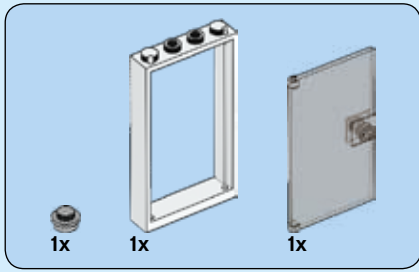

16

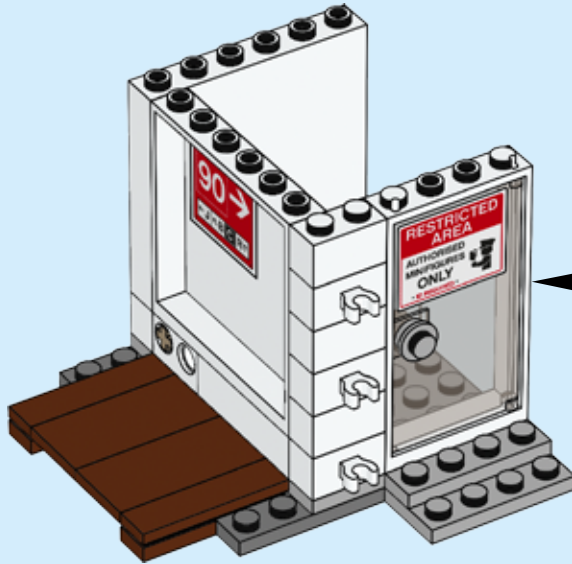
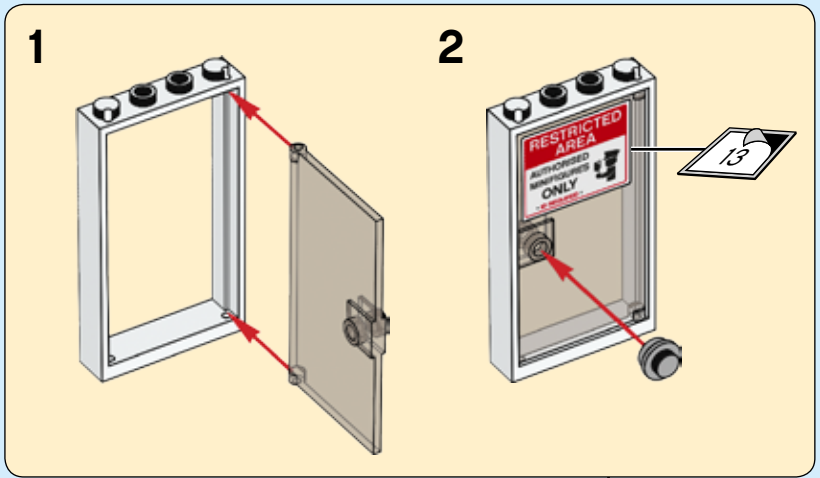

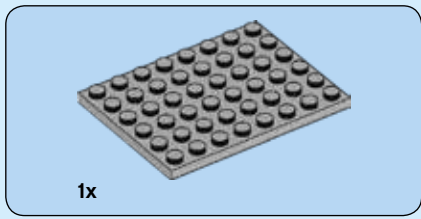

17

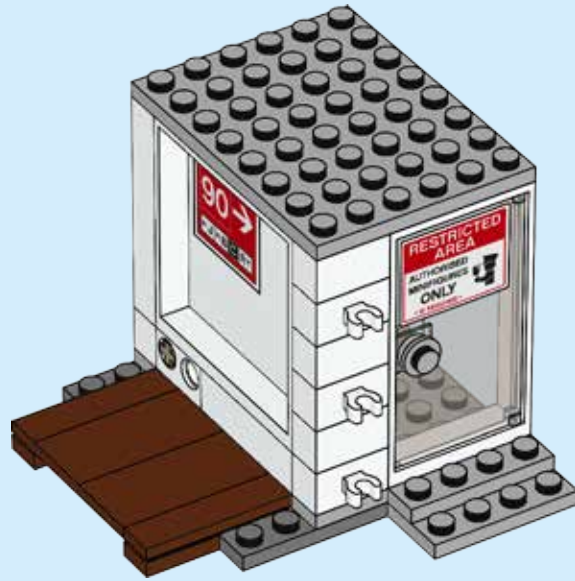

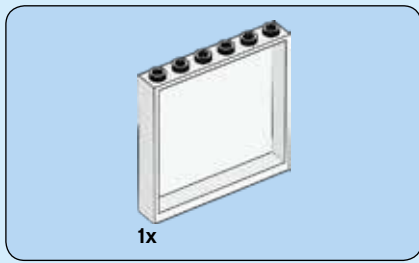

18

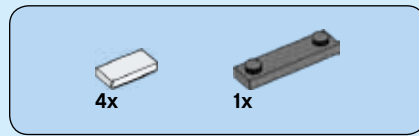
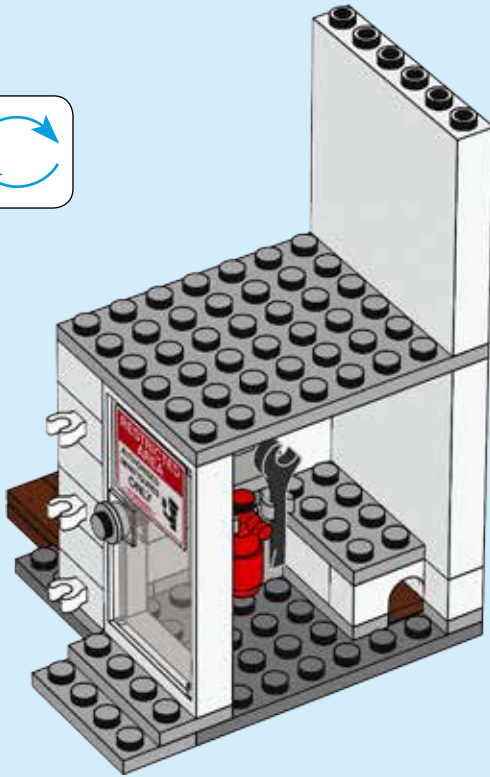
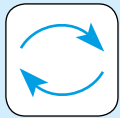

19

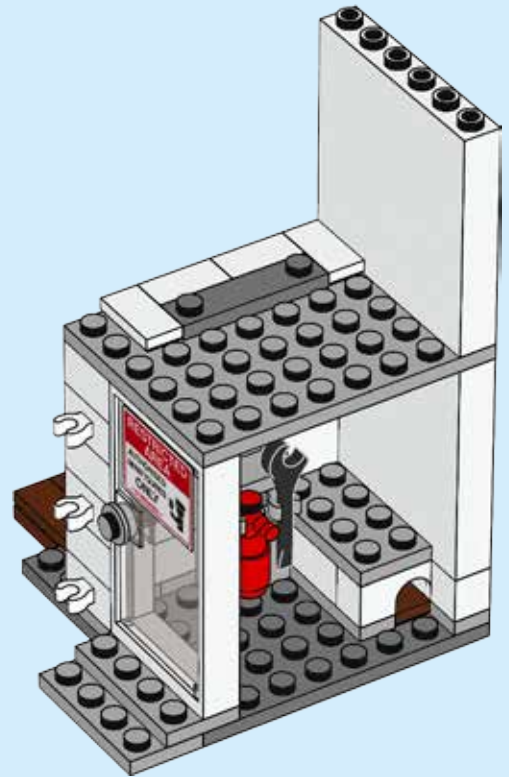

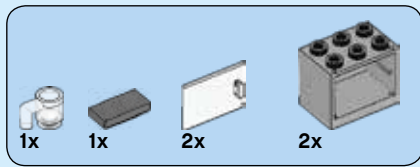

# 20

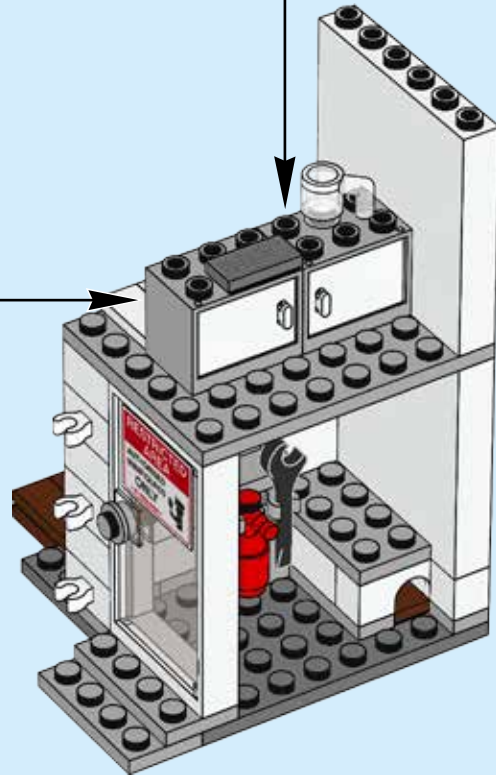
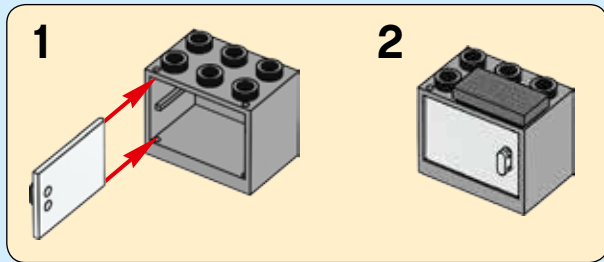
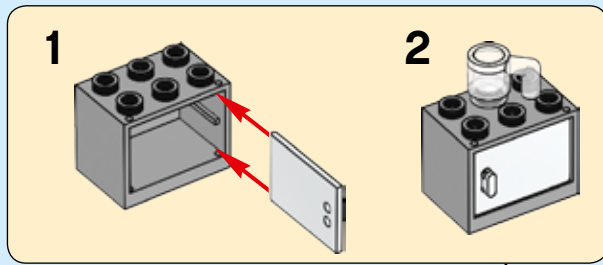





1x



1x

# 21

1

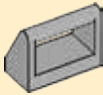

2

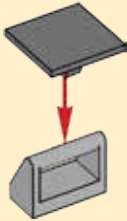

3

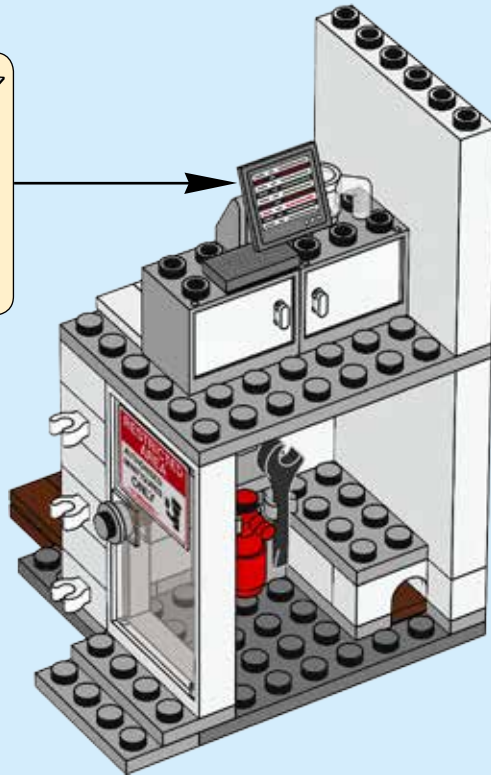

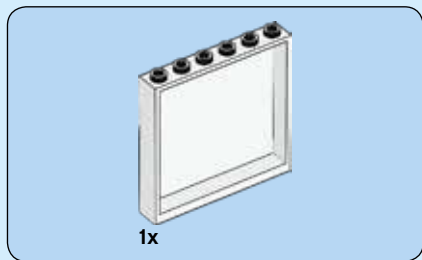

22

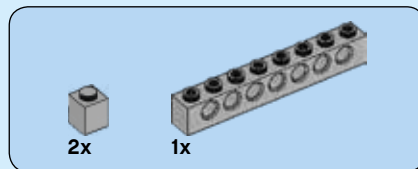
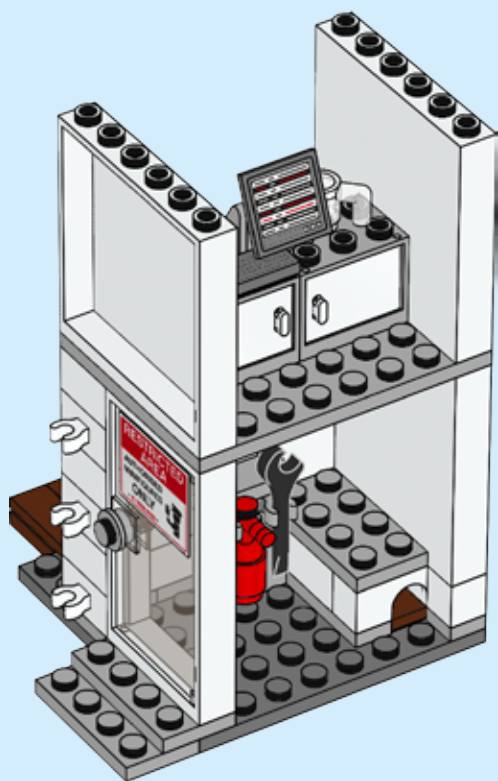

23

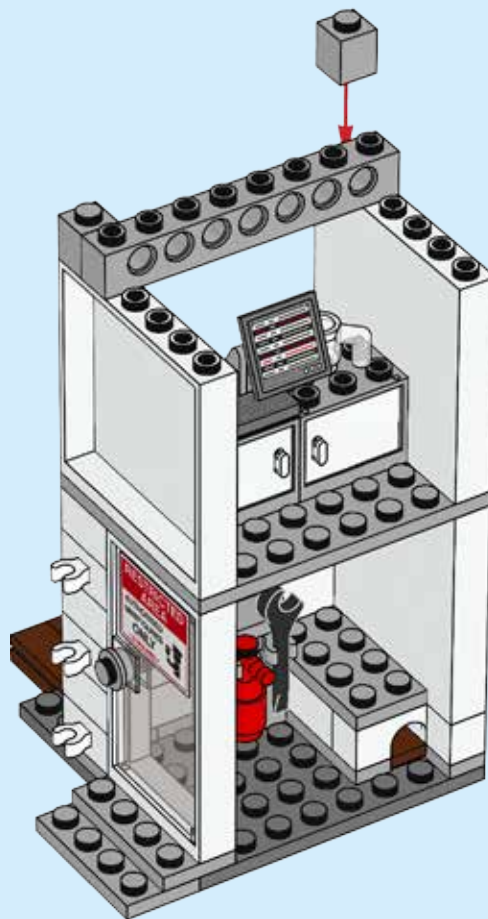

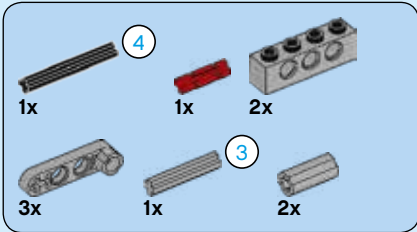
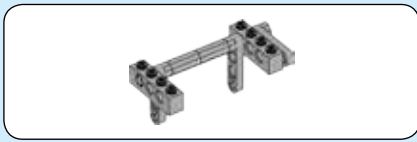

24

1

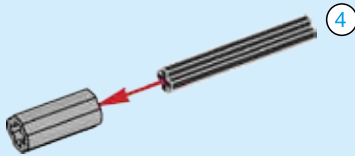

2

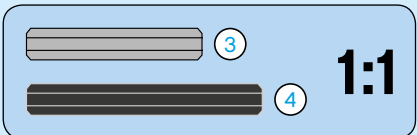
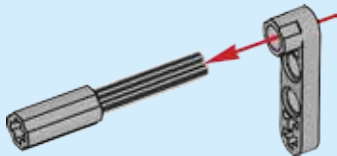

3

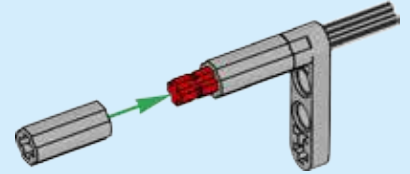

4

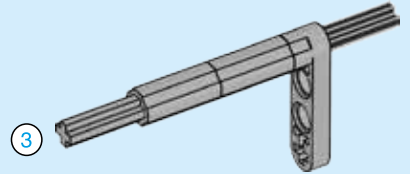

5

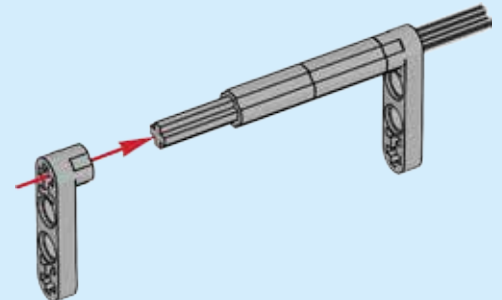

6

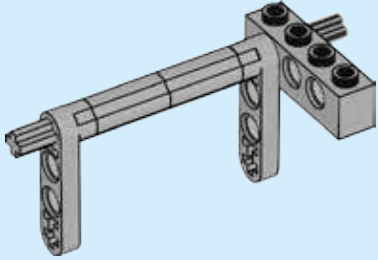

7

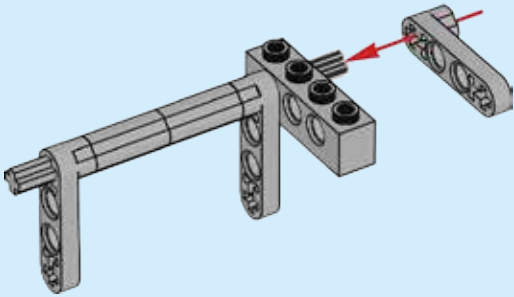

8

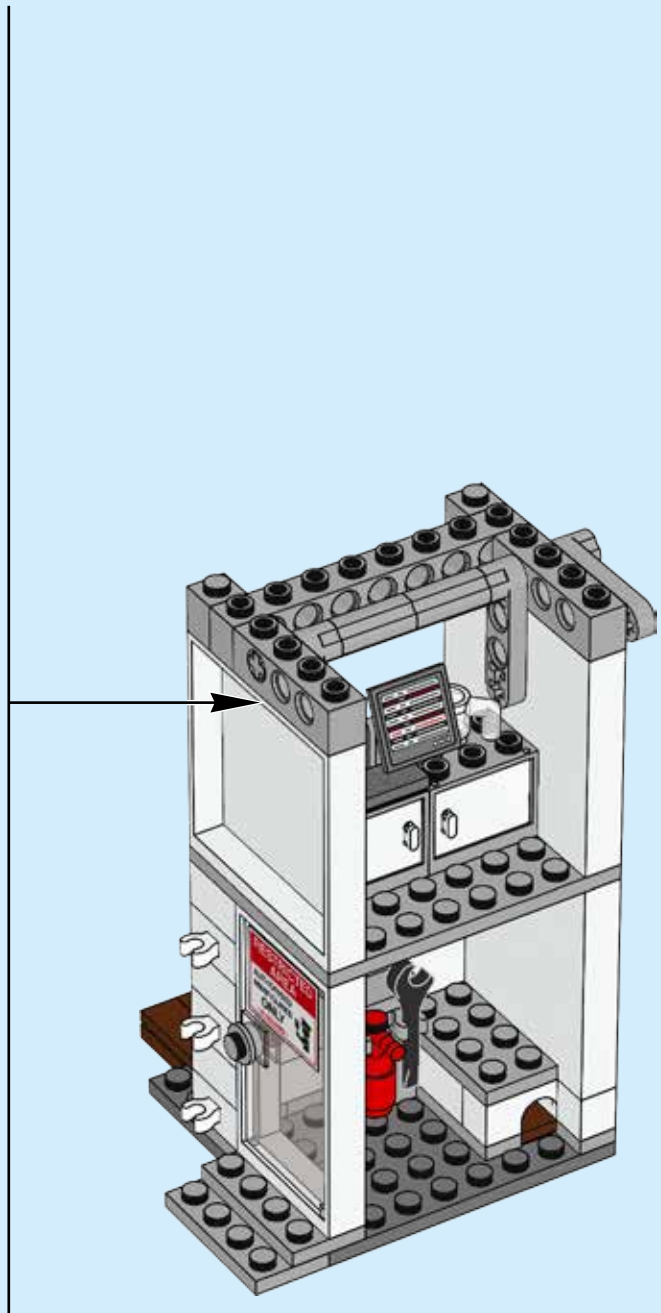
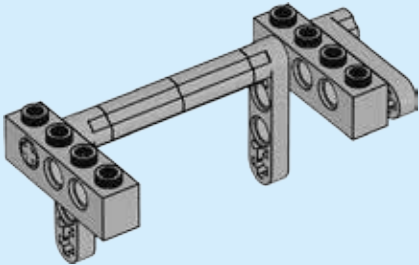

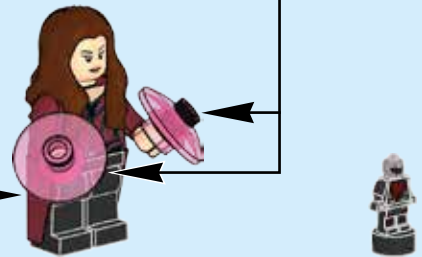
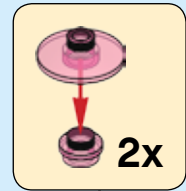
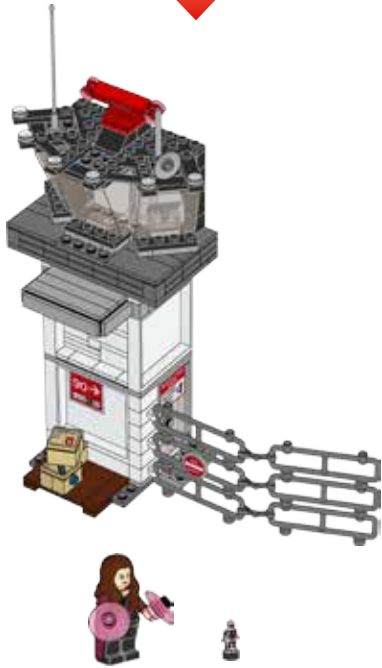
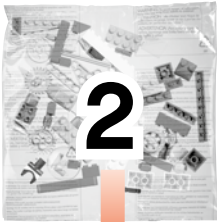

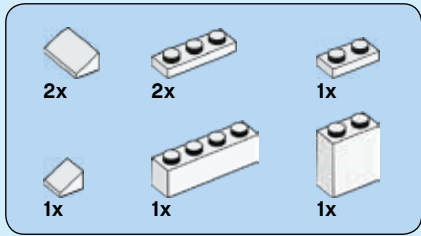

# 25

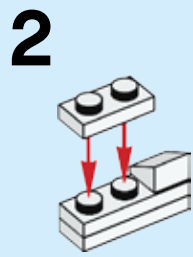
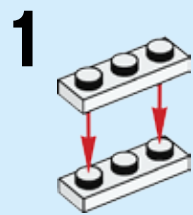

# 3

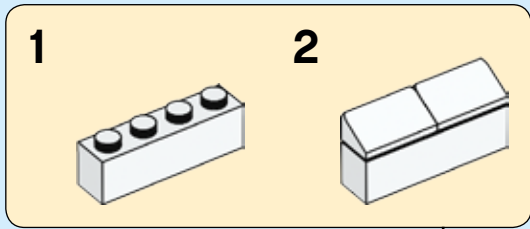
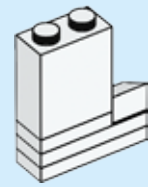

# 4

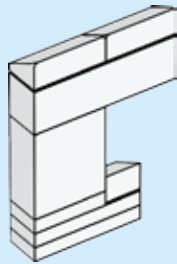

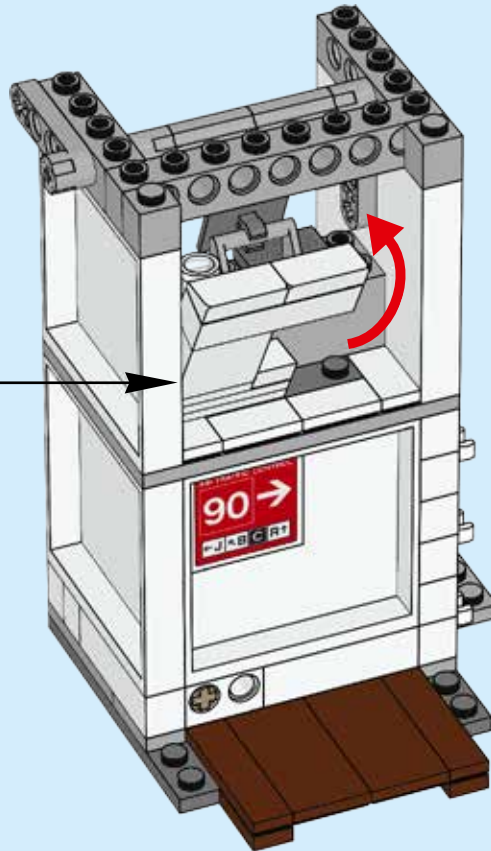
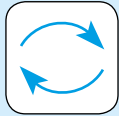

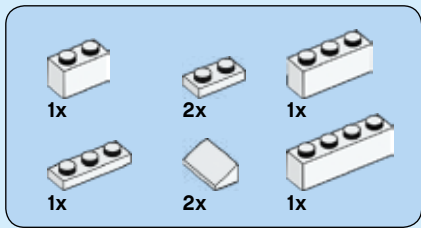

# 26

1

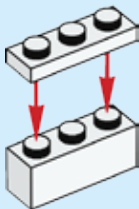

2

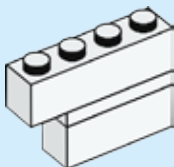

3

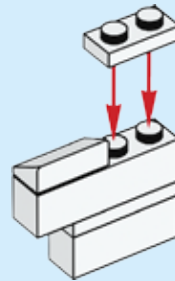

4

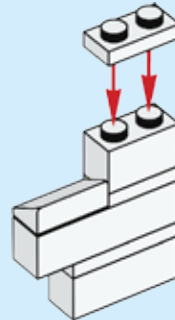

5

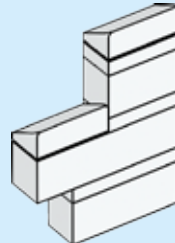



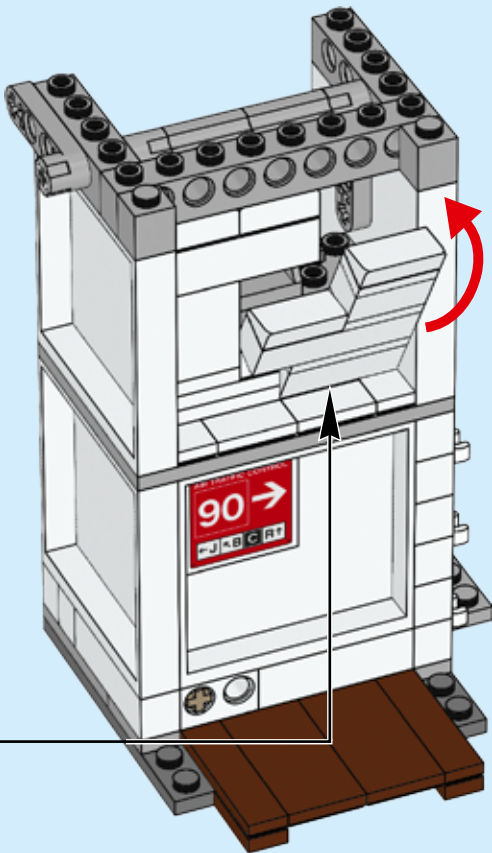

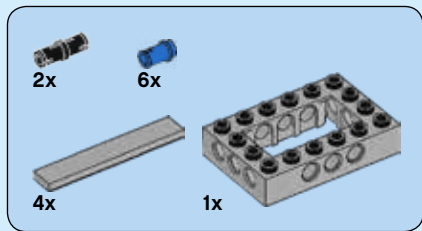

27

1

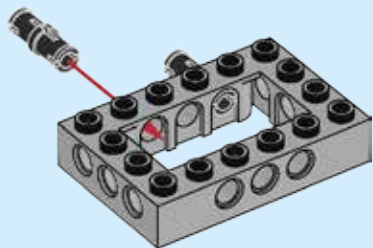

2

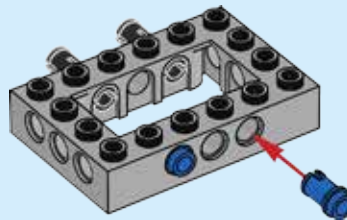

3

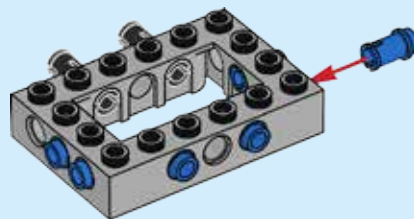

4

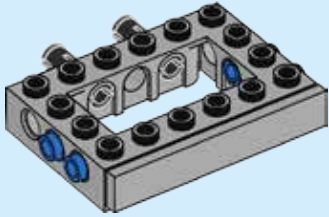

5

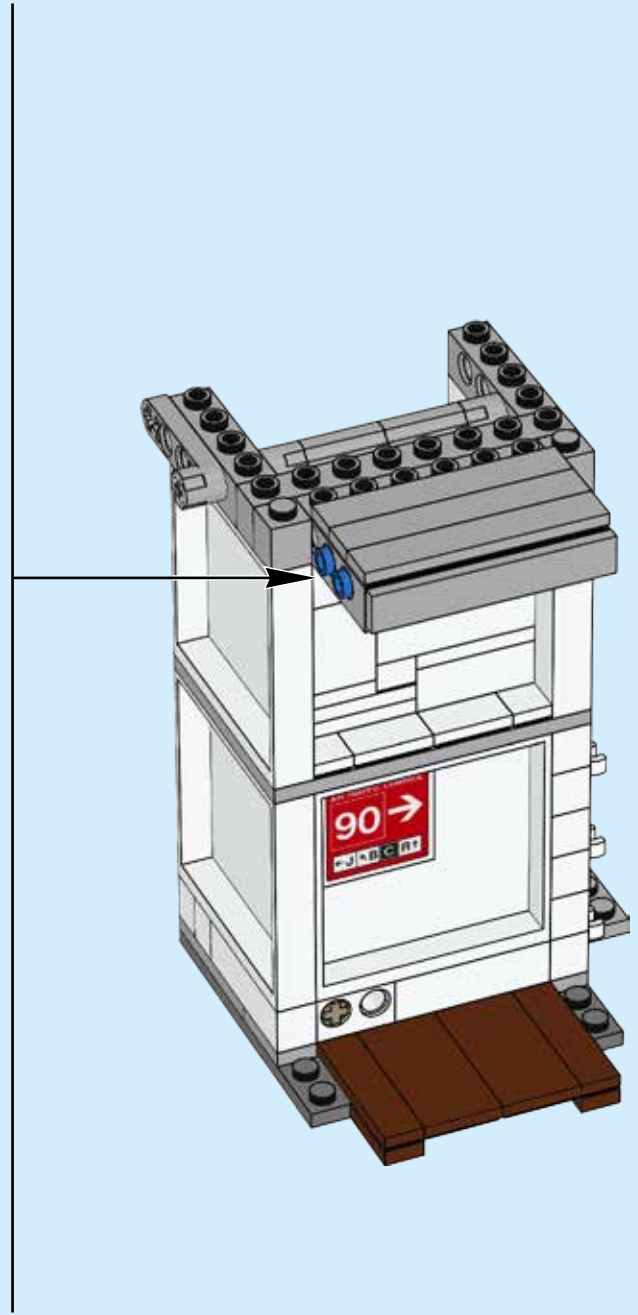
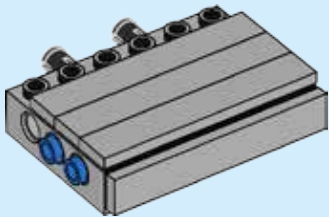



2x

# 28

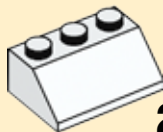

2x

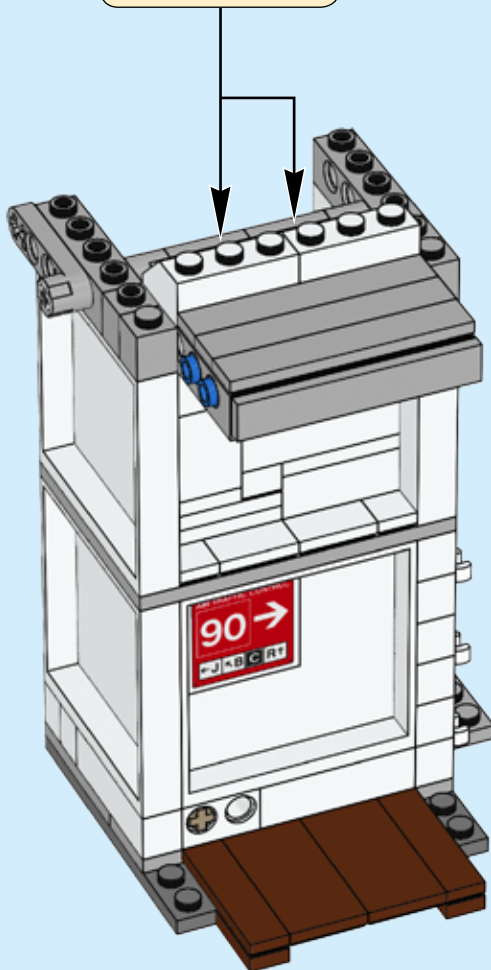

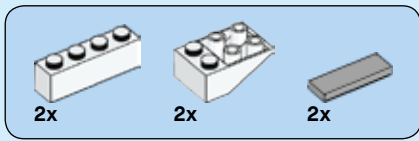

# 29

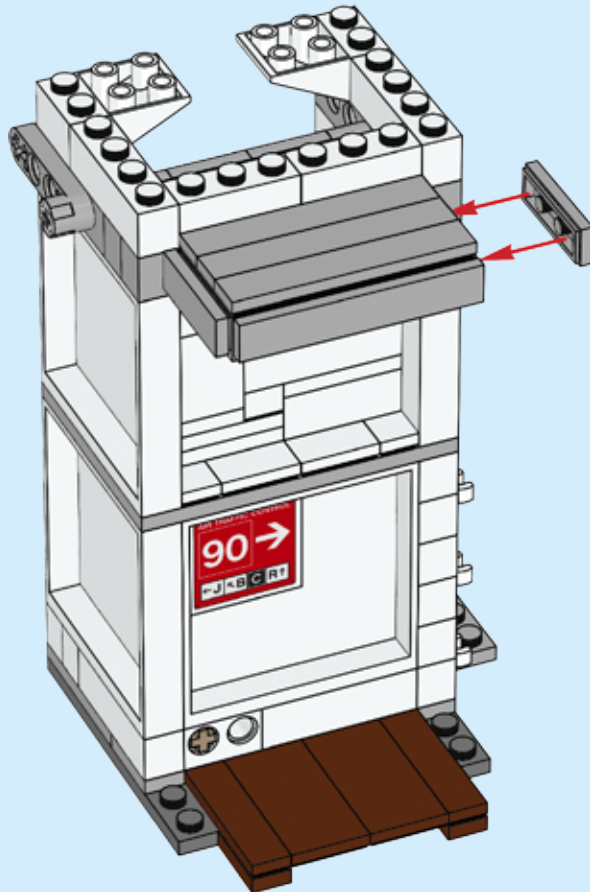

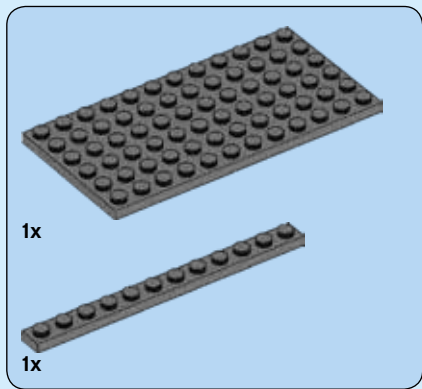

**30**

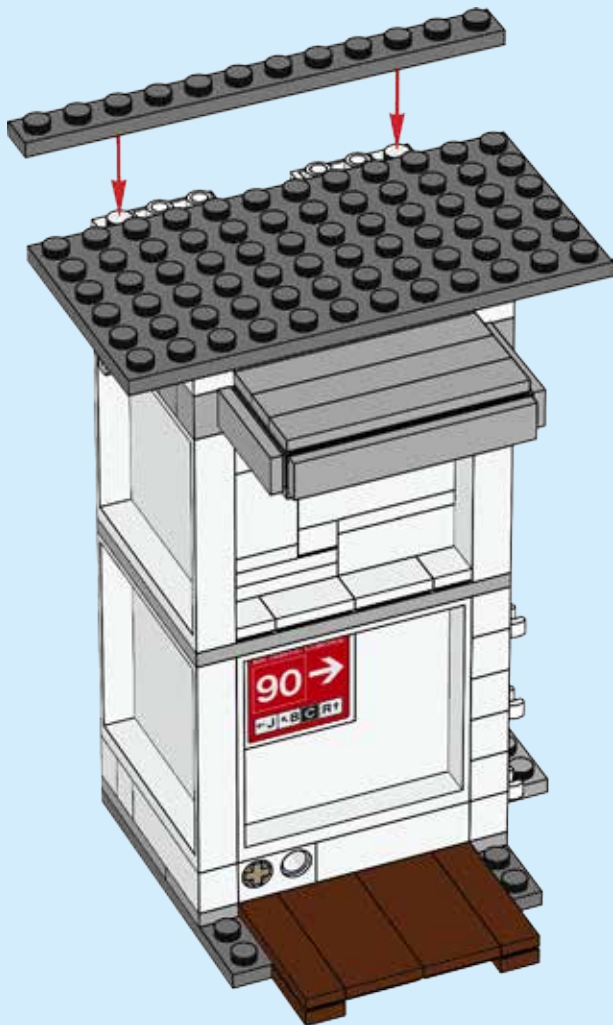



1x



2x



1x



2x

# 31

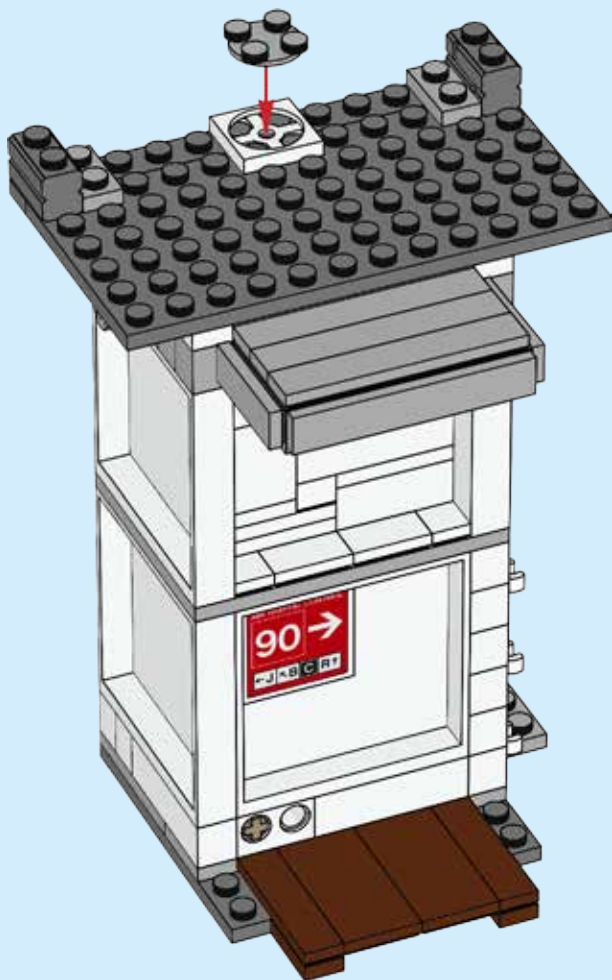

2x



4x

# 32

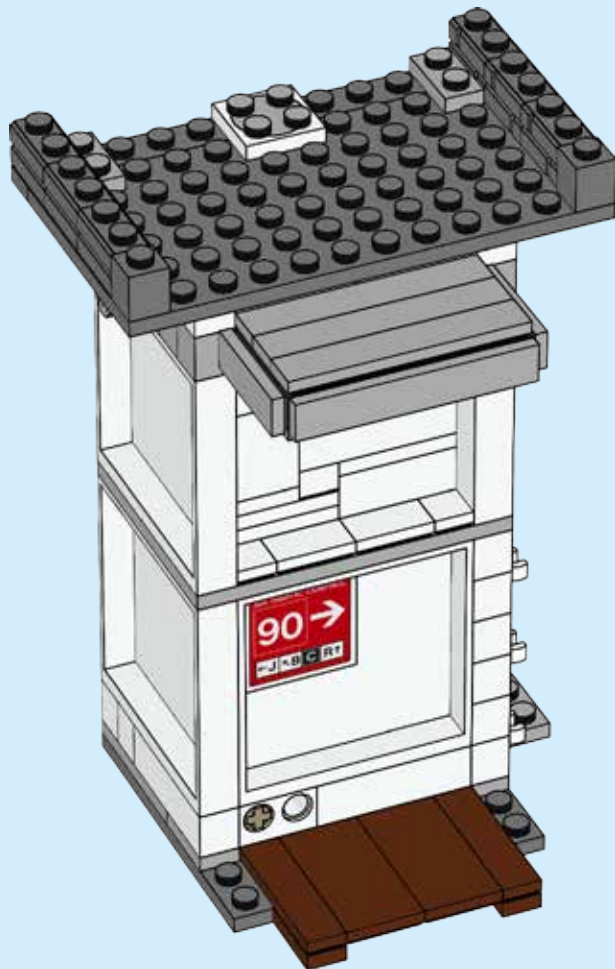



# 33

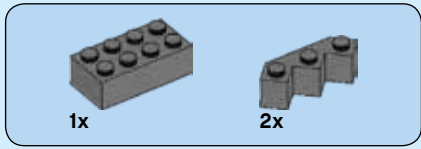
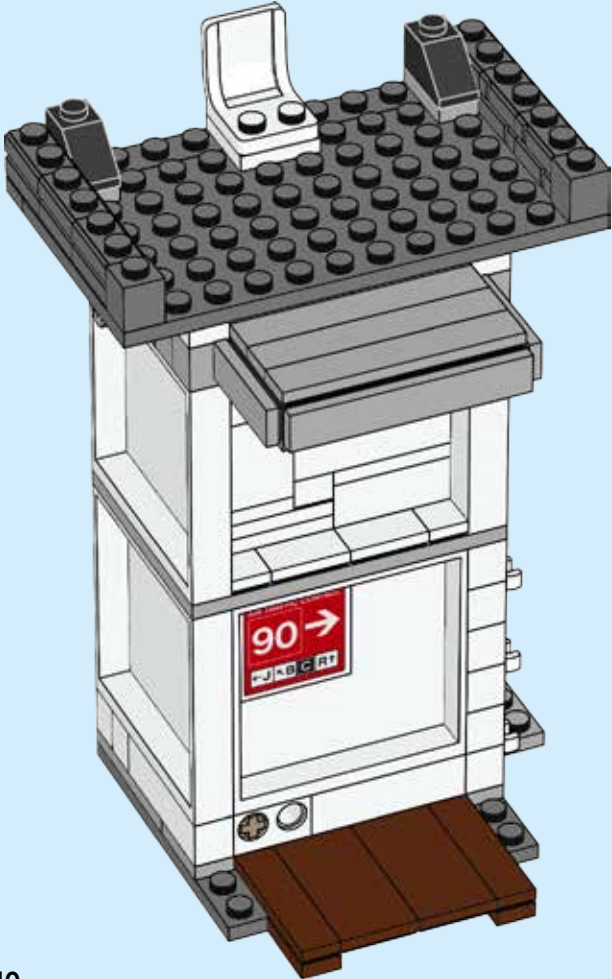

# 34

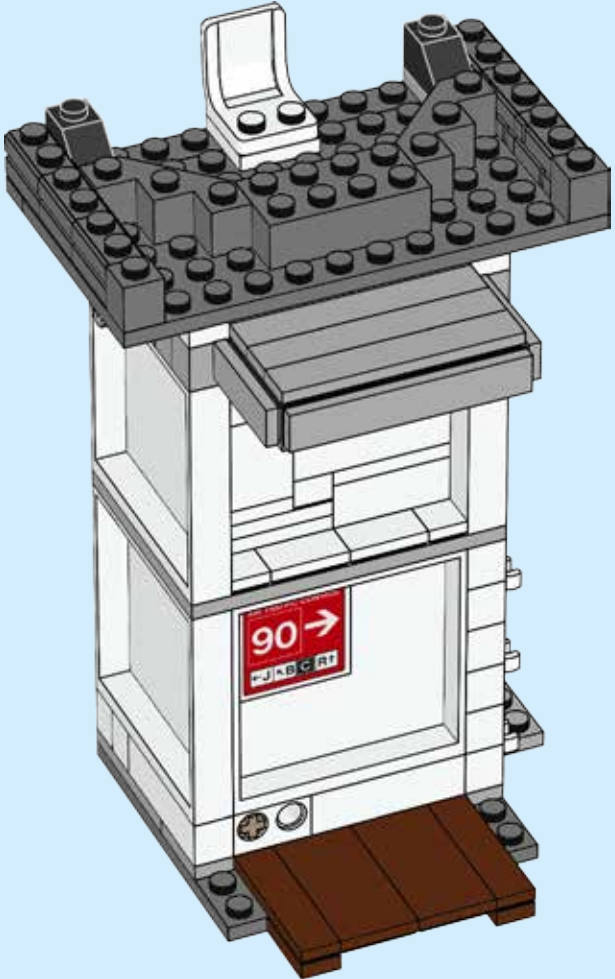





5x

# 35

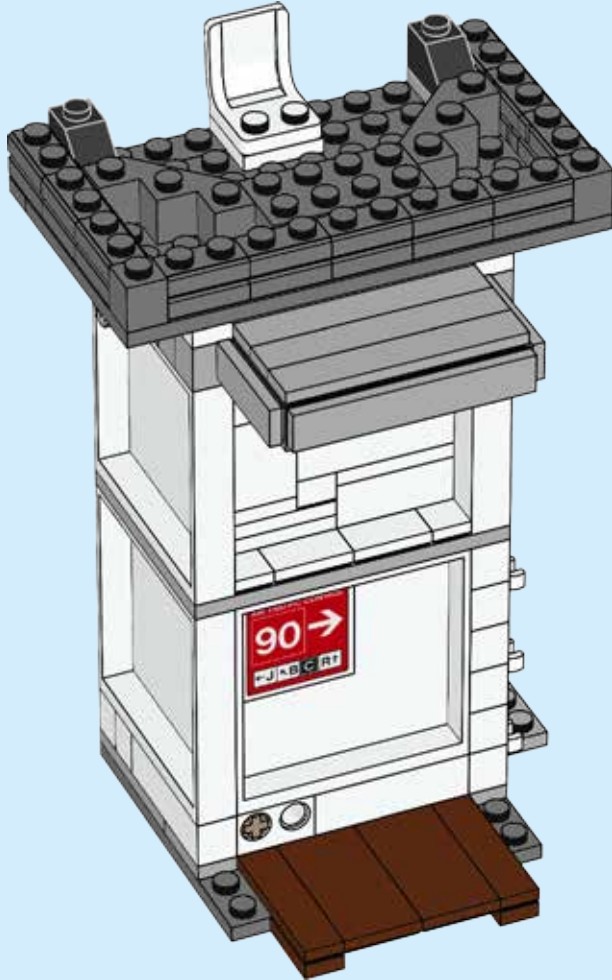

2x



4x

# 36

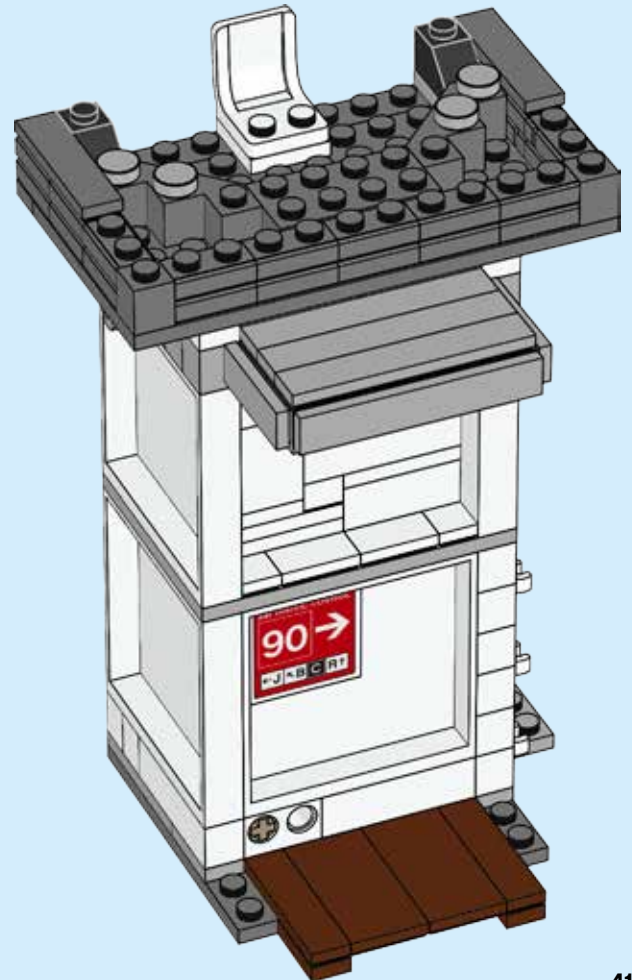

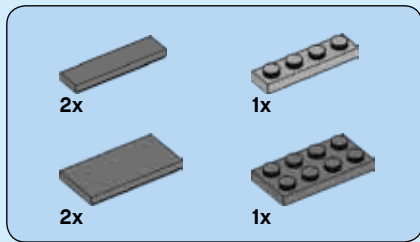

37

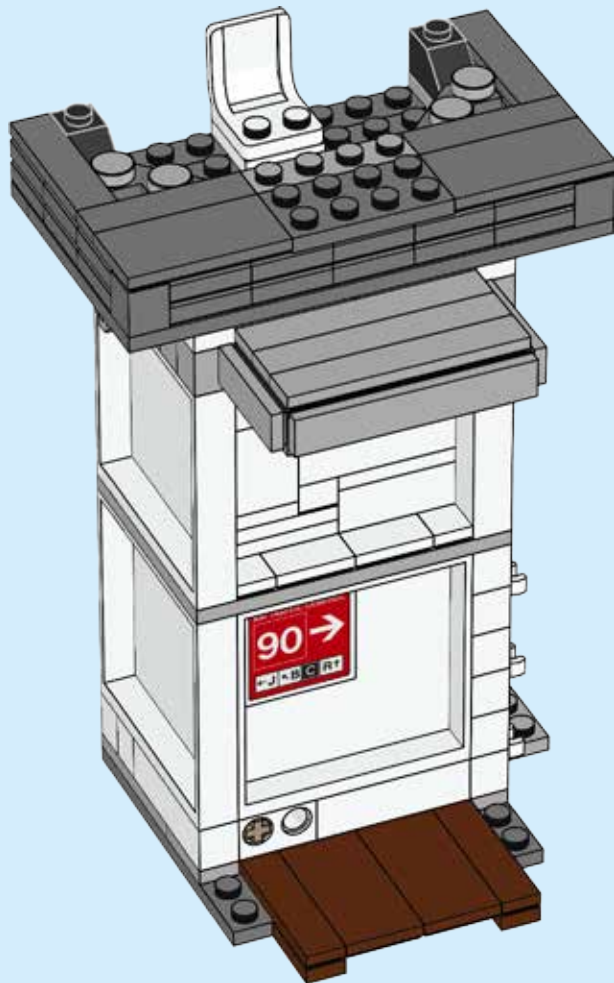



2x



2x

# 38

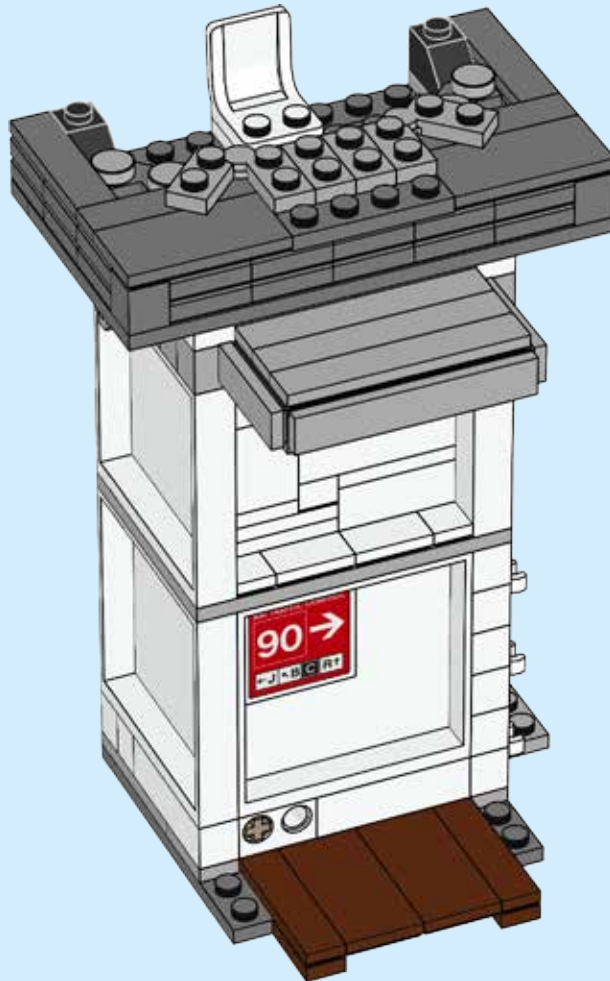

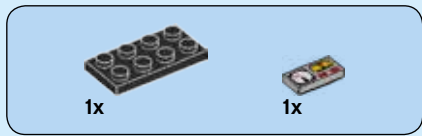

39

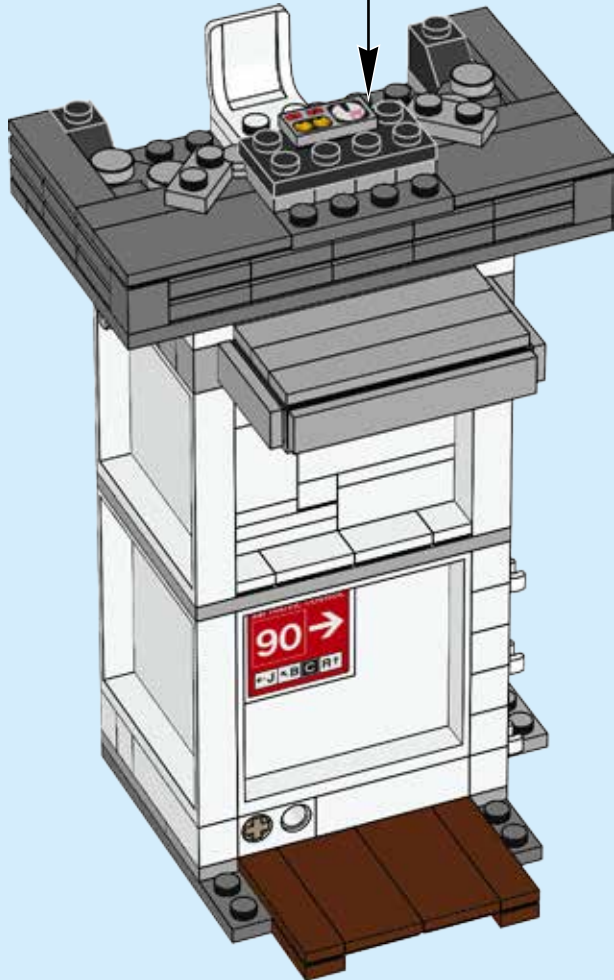
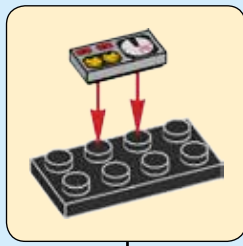

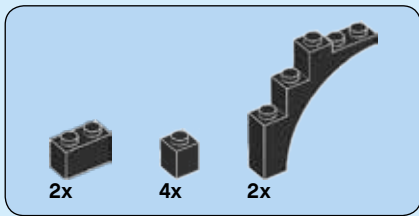

40

1

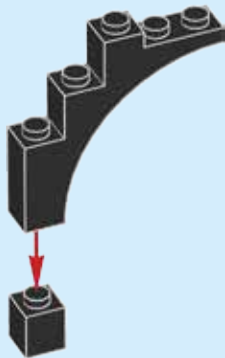

2

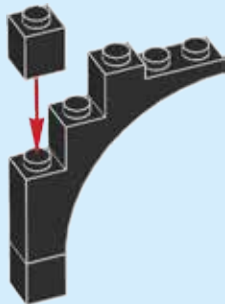

3

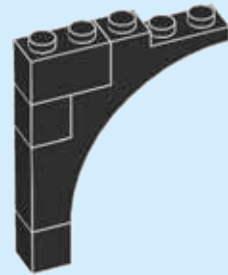

2x

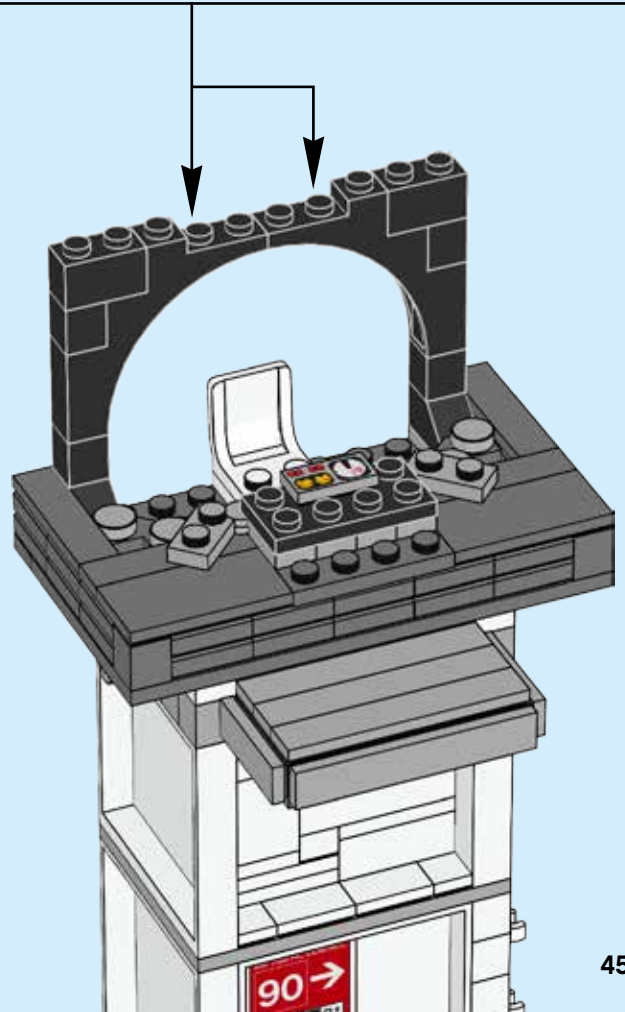

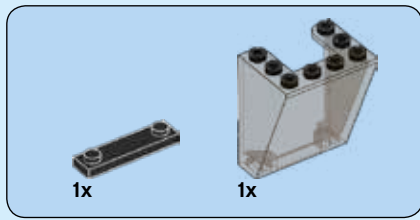

41

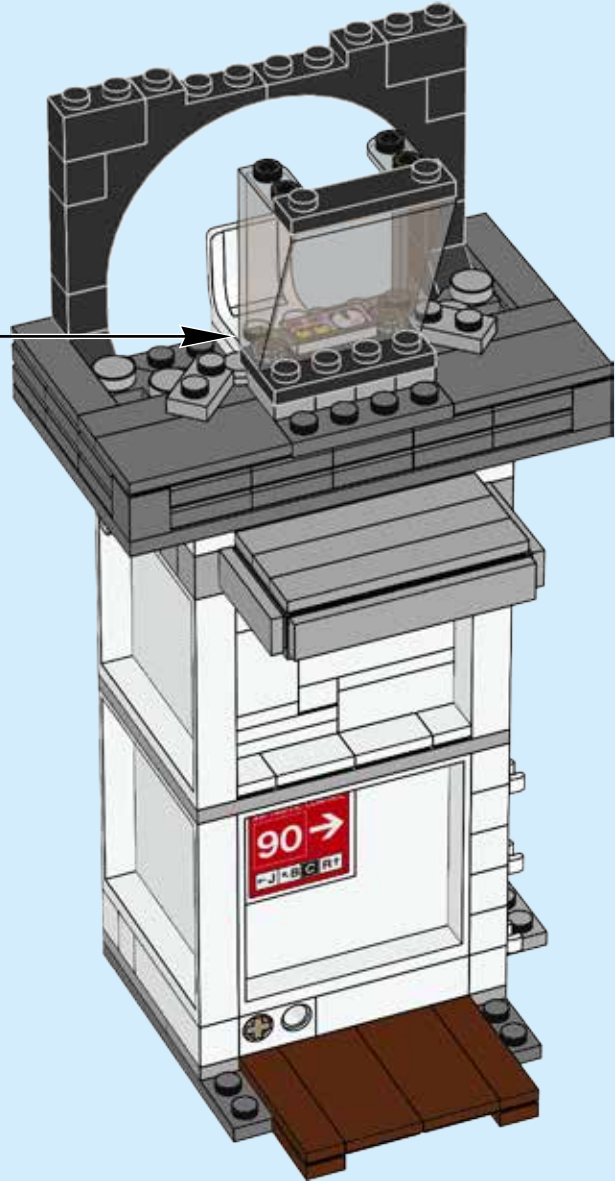
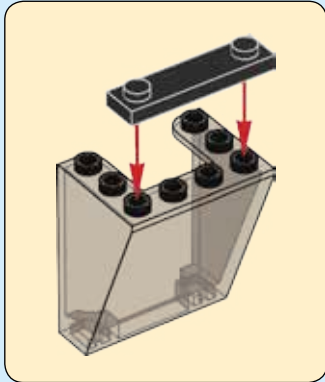

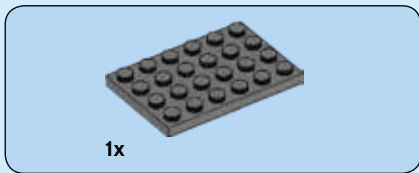

42

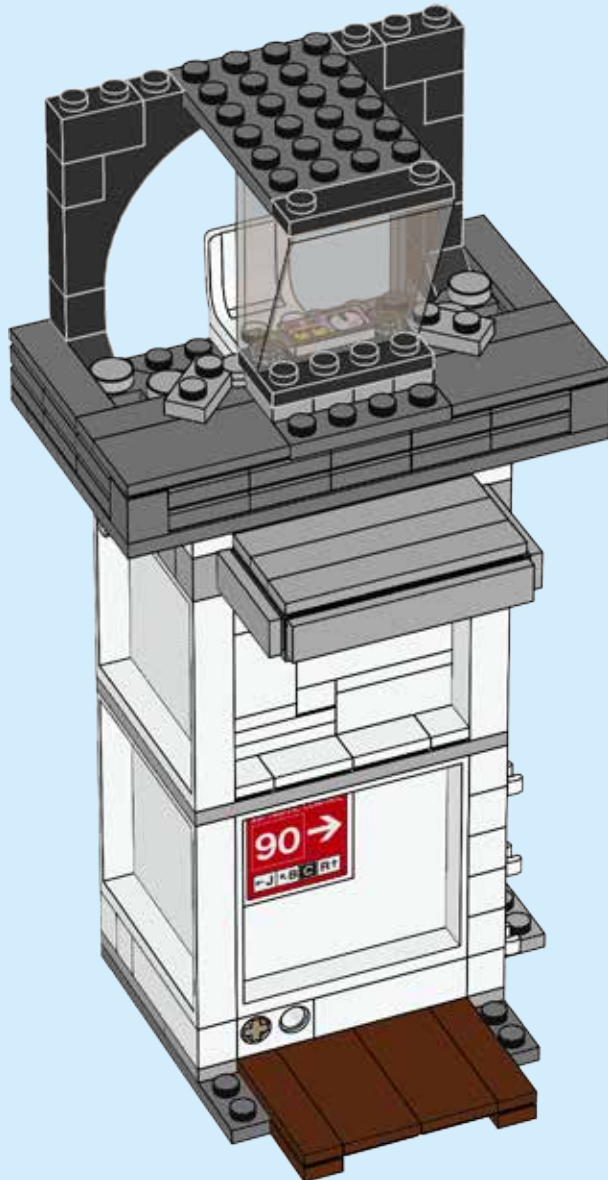

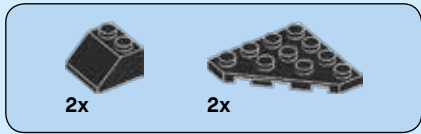

# 43

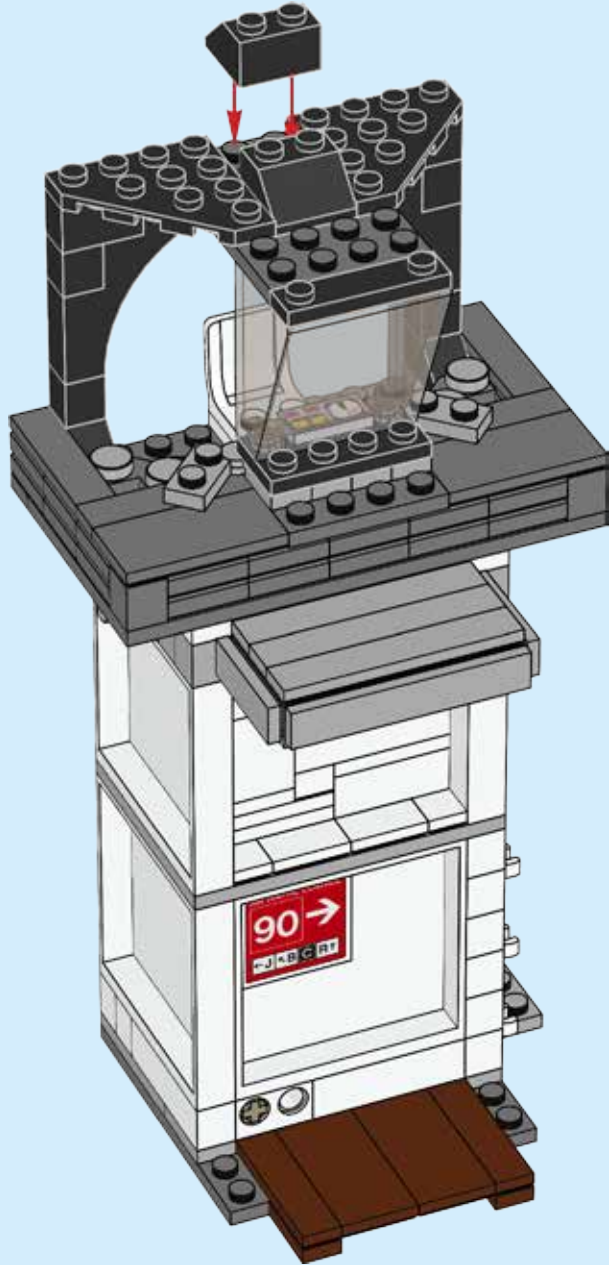



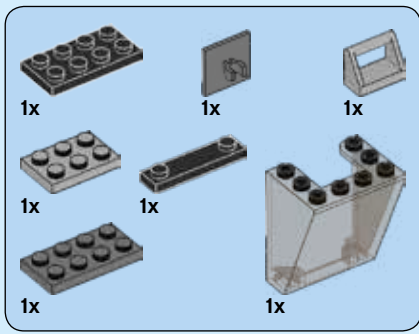

# 44

## 1

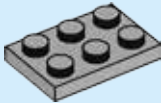

## 2

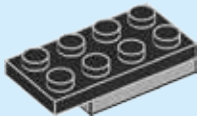

## 3

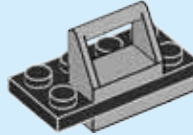

## 4

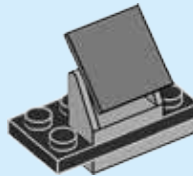

## 5

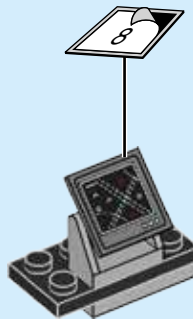

## 6

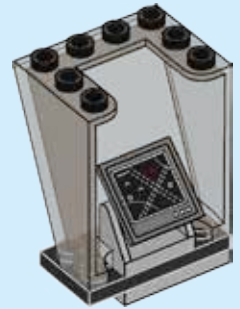

## 7



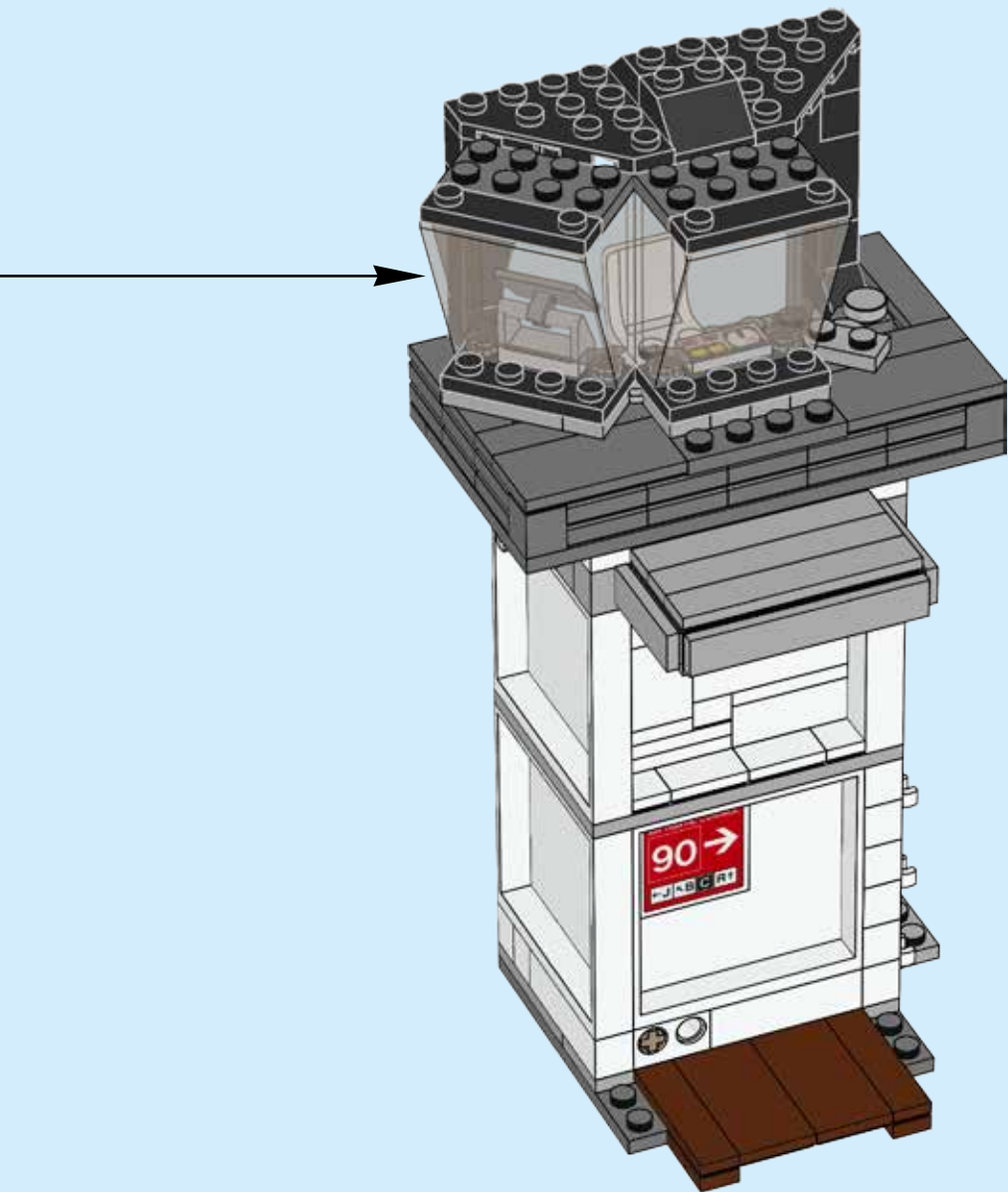

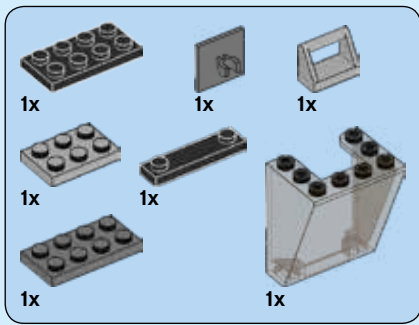

# 45

1

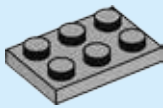

2

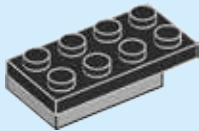

3

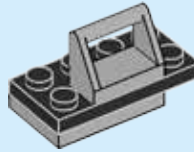

4

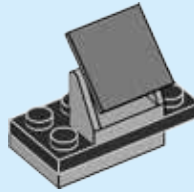

5

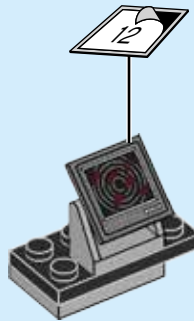

6

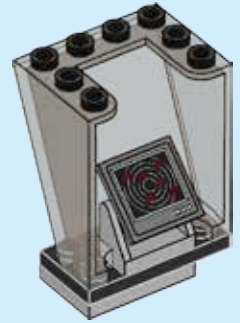

7



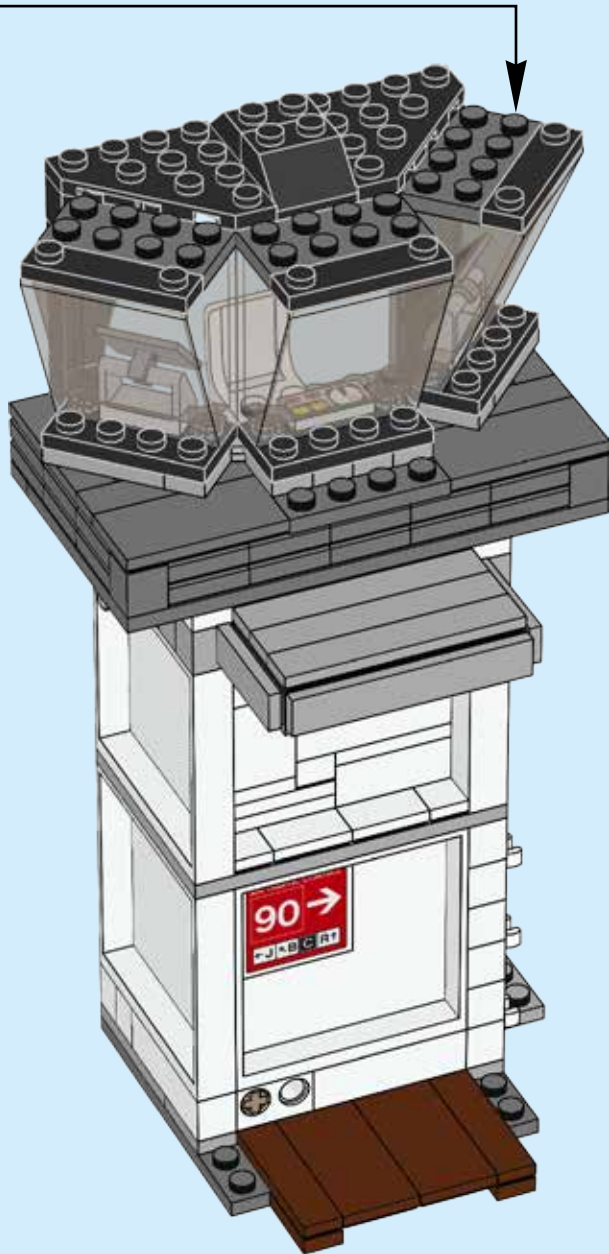



2x



2x

# 46

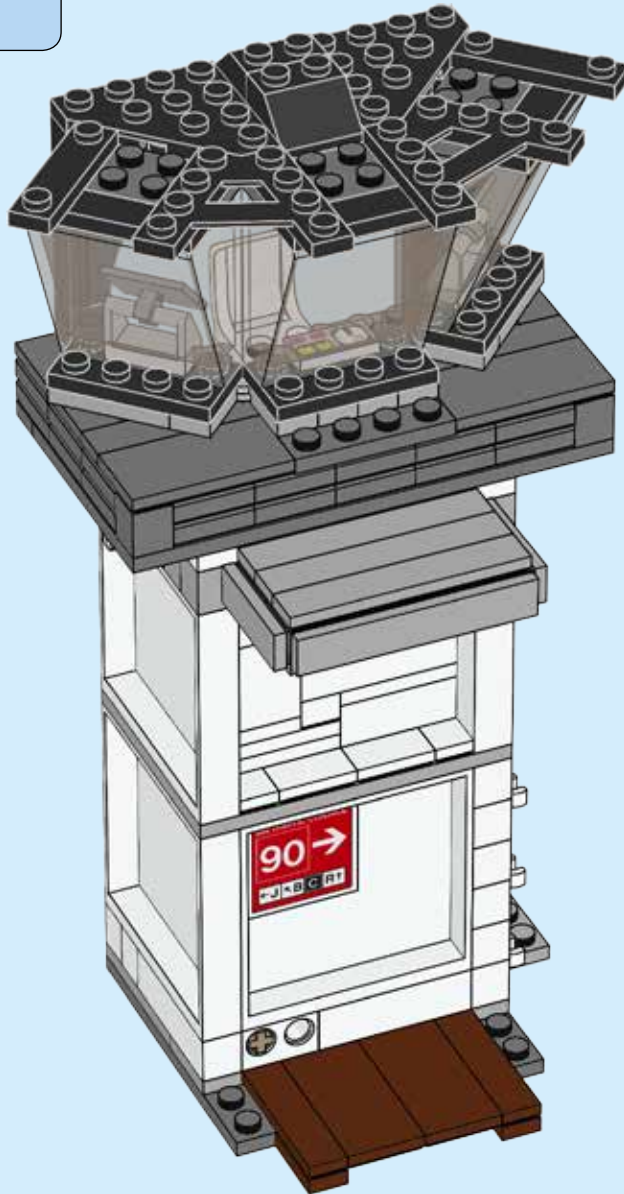



# 47

1

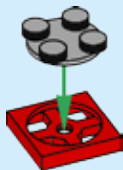

2

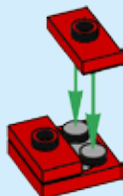

3

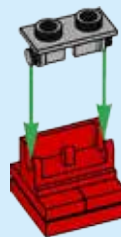

4



5

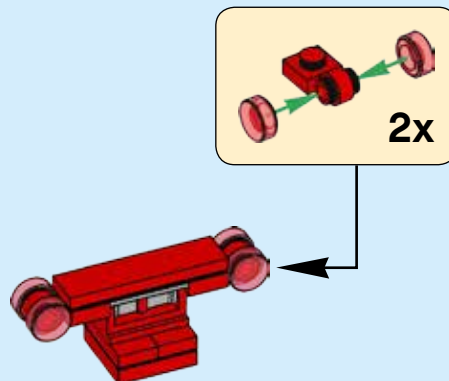

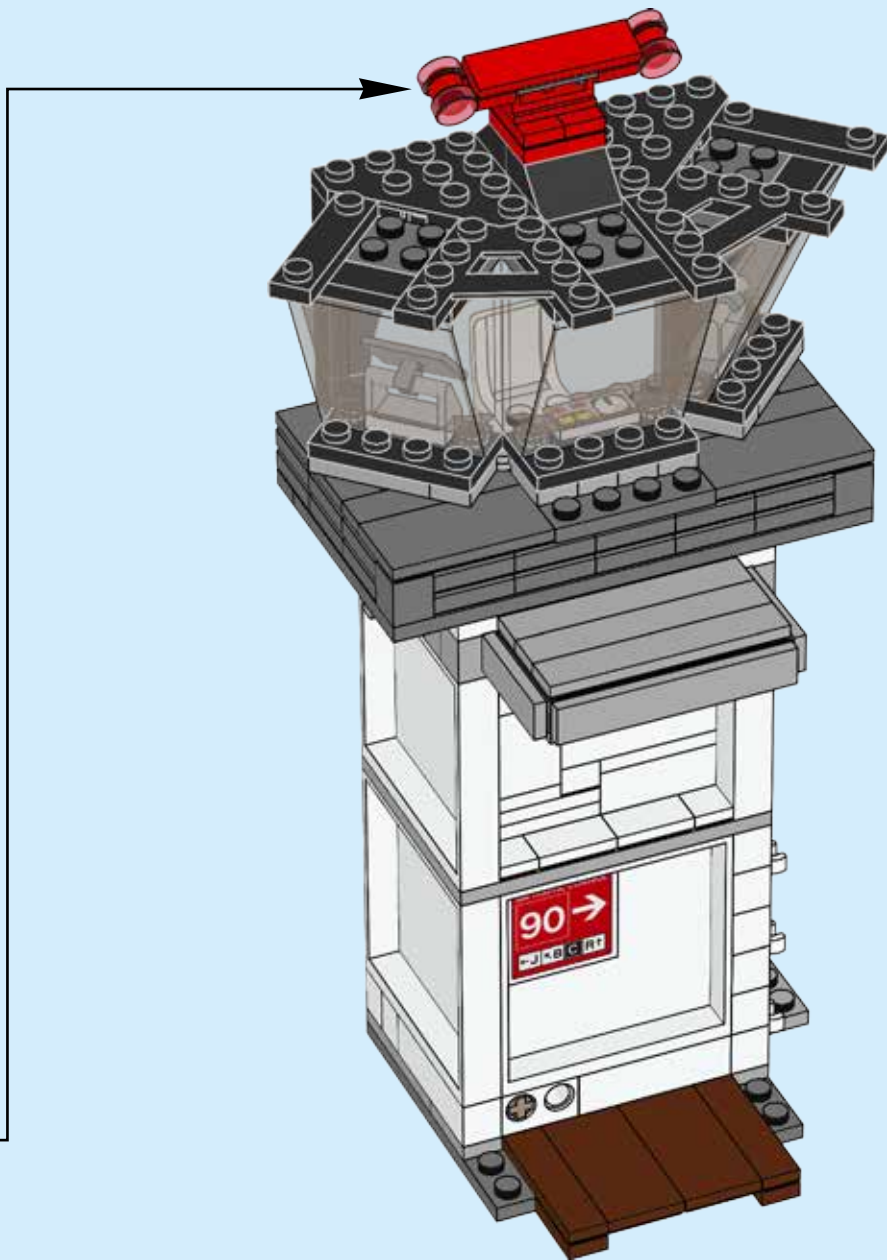

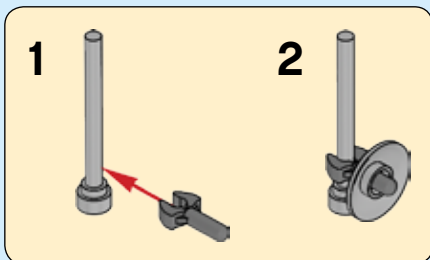
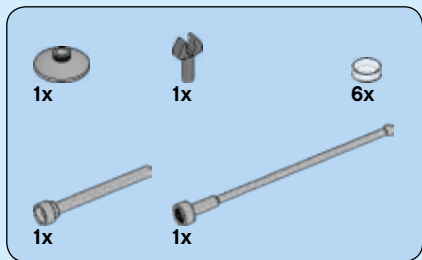

48

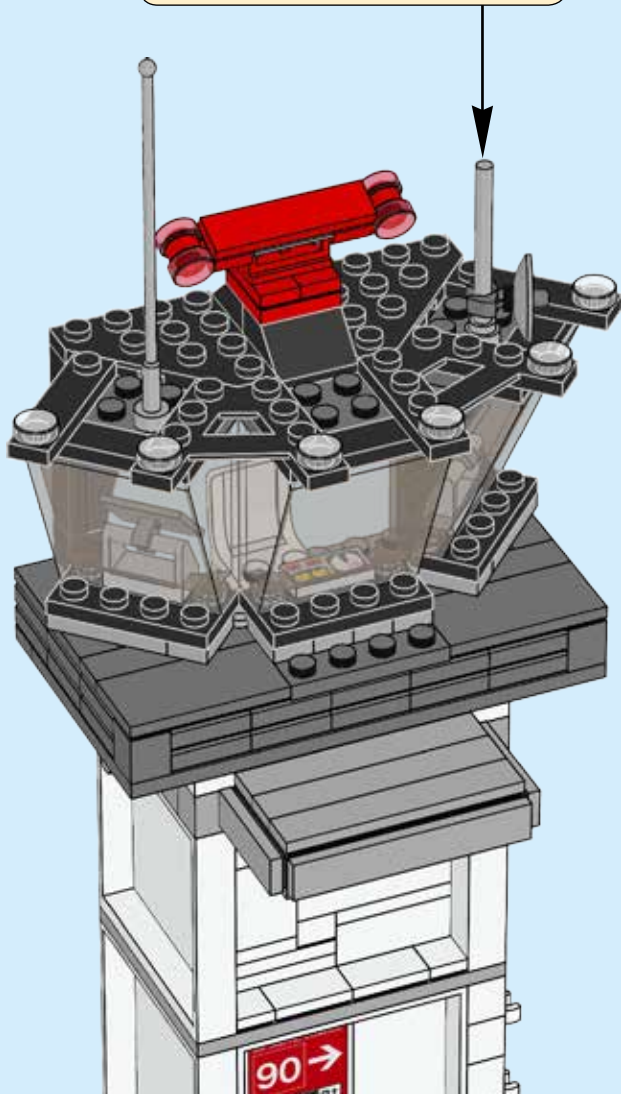





3x



3x



3x



3x

# 49

1

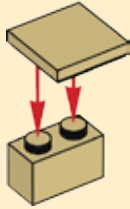

2

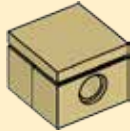

3

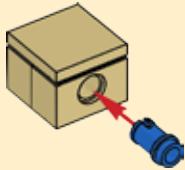

3x

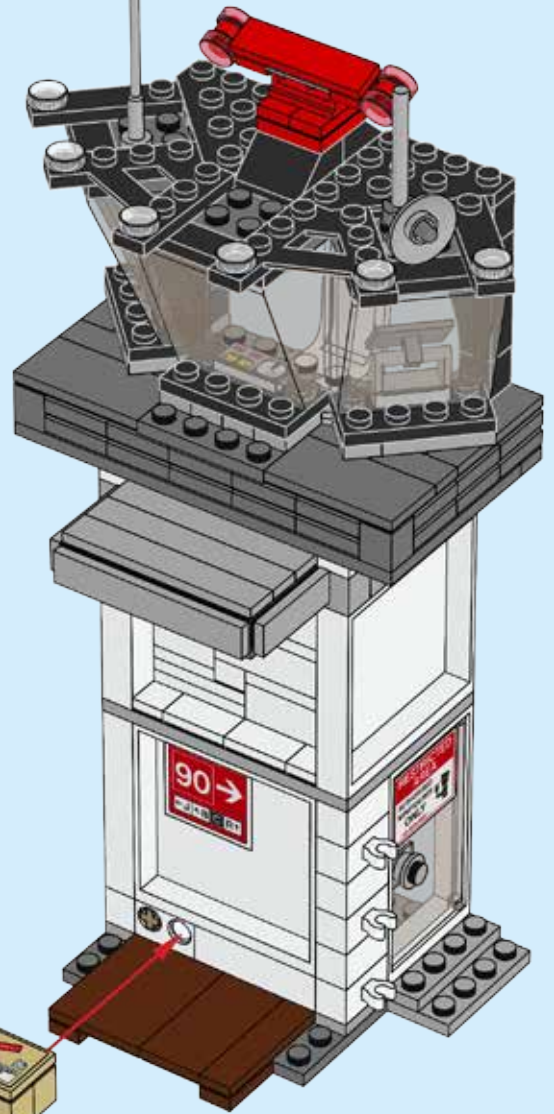
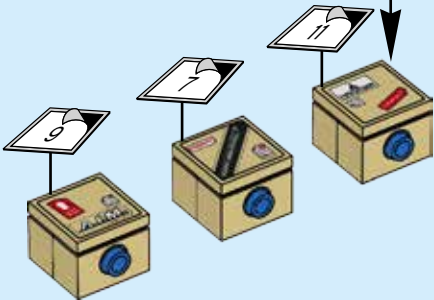

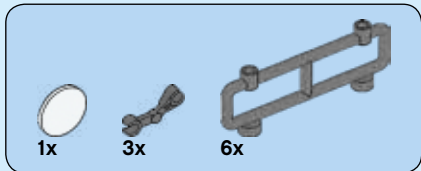
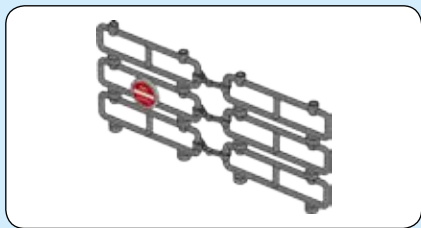

# 50

## 1

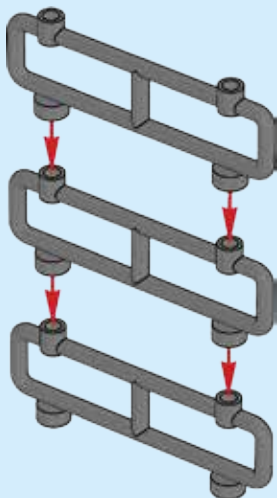

## 2

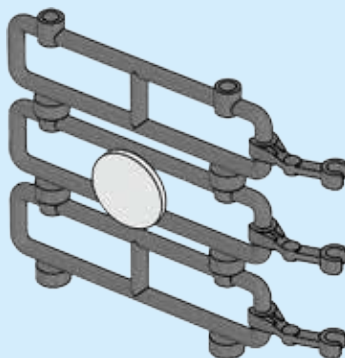

**3**

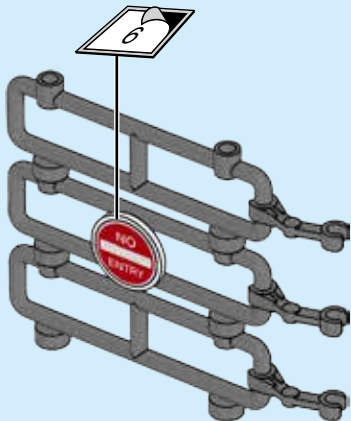

**4**

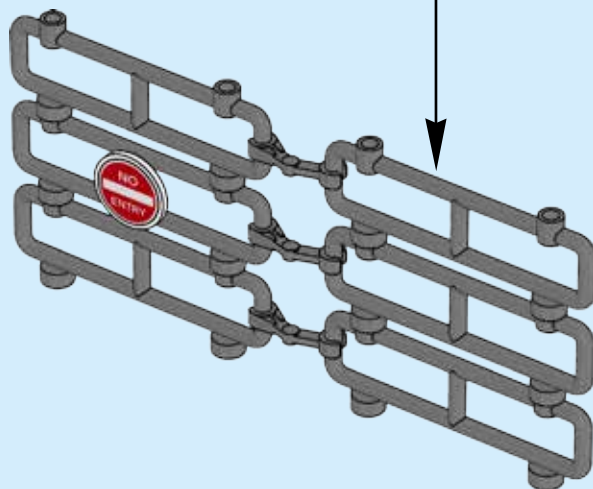

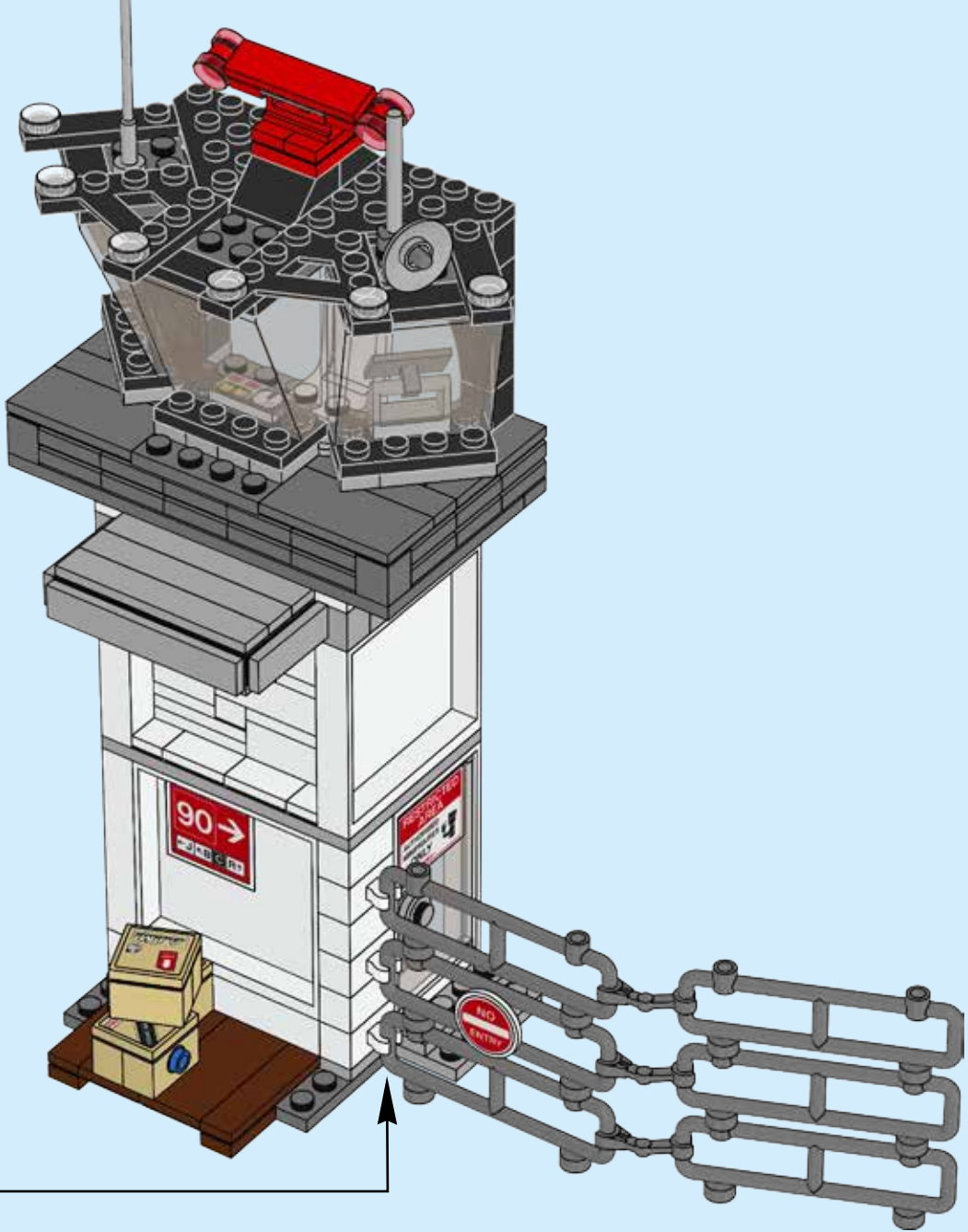



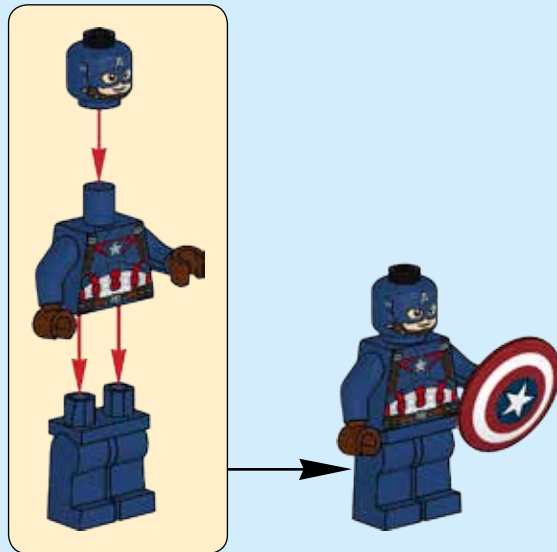
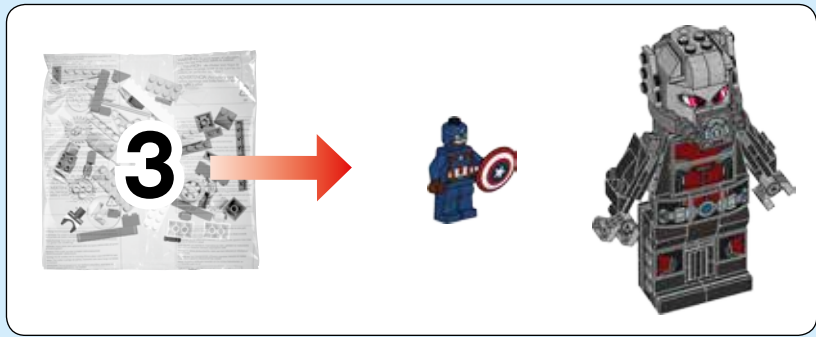

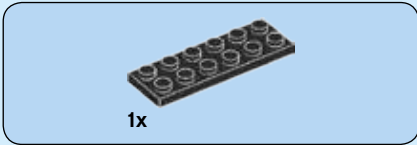

1x

# 1

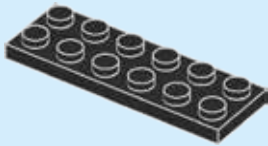

1x

1x

# 2

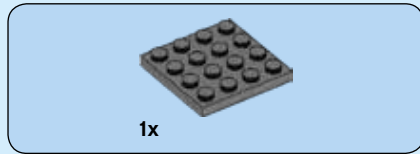
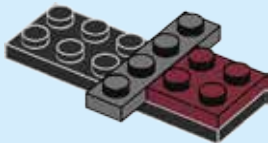

1x

# 3

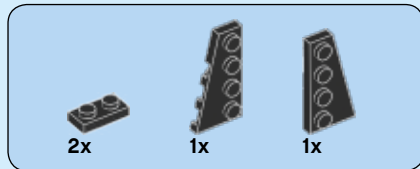
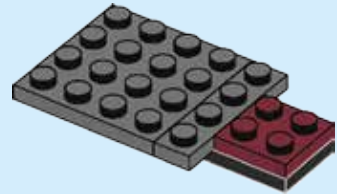

2x

1x

1x

# 4

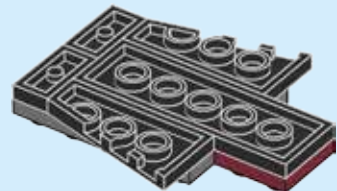
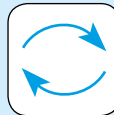



2x

# 5

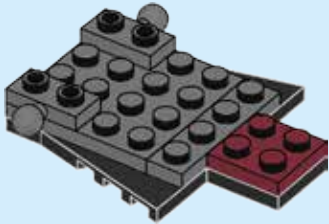
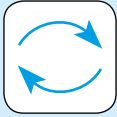

1x



1x



1x

# 6

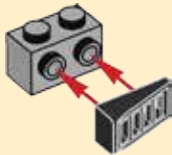
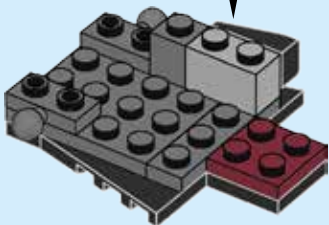

2x



1x

# 7

## 1

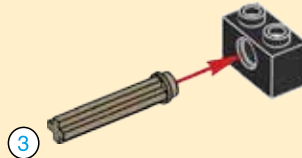

## 2

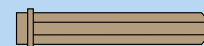
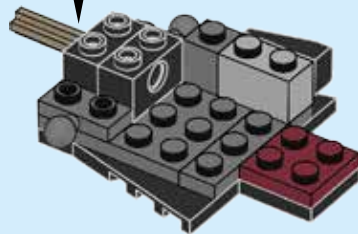
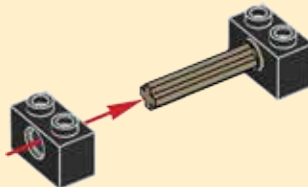

3

# 1:1



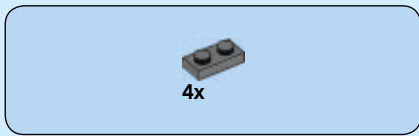

8

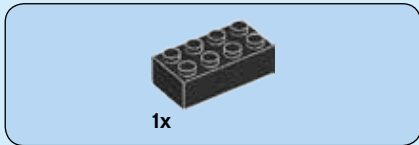
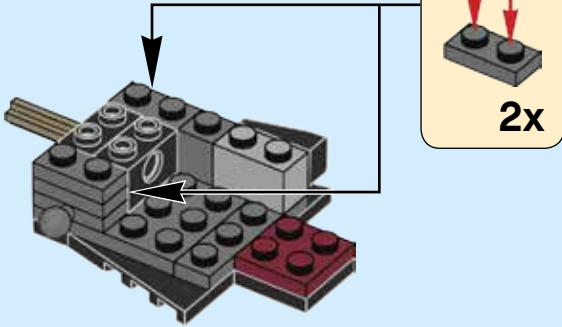

9

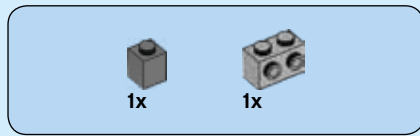
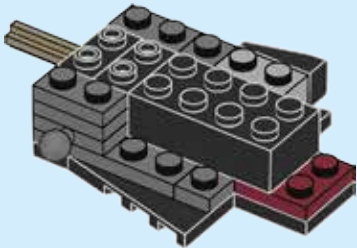

10

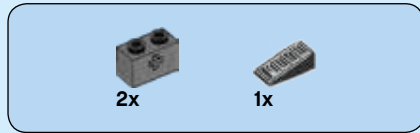
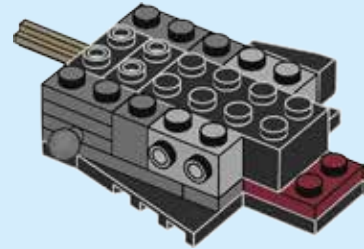

11

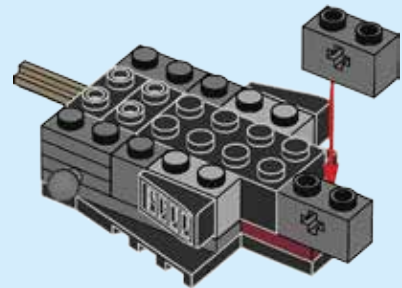

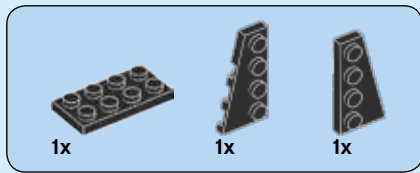

12

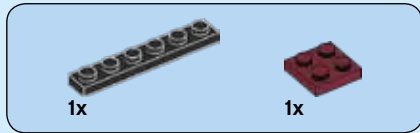
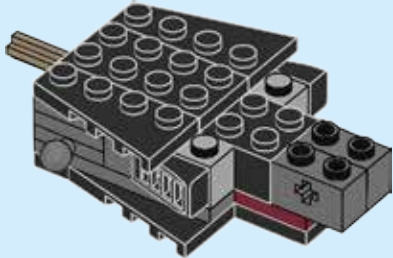

13

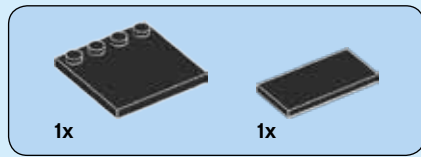
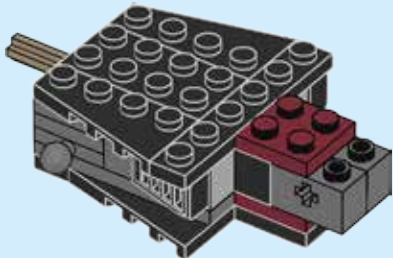

14

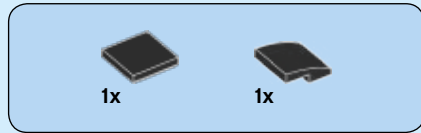
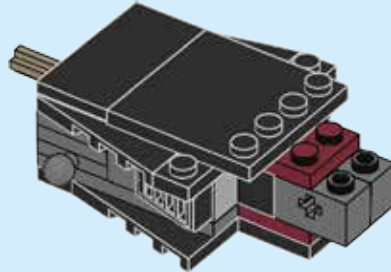

15

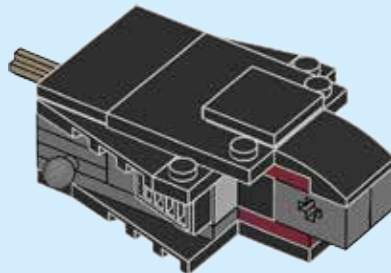

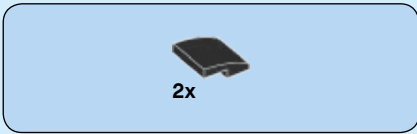

16

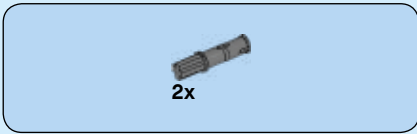
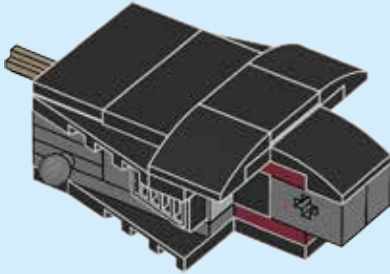

17

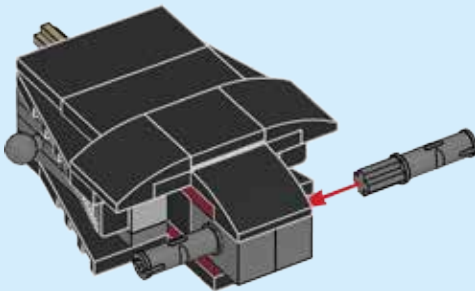

18

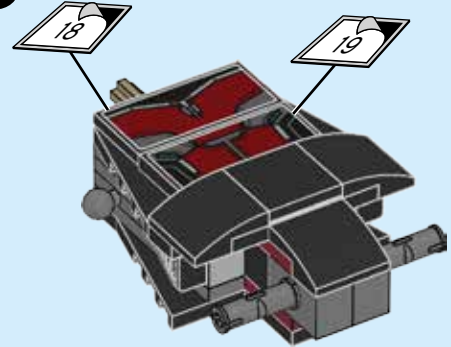

19

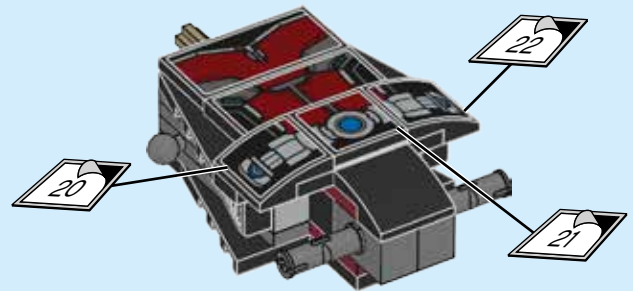

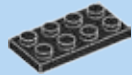

1x

# 20

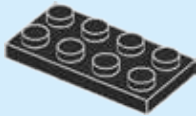

1x



1x

# 21



1x

# 22



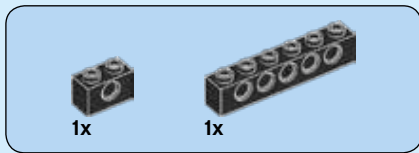

# 23

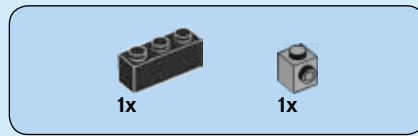
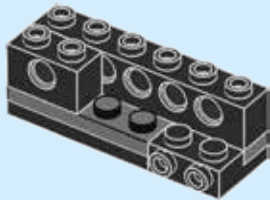

# 24

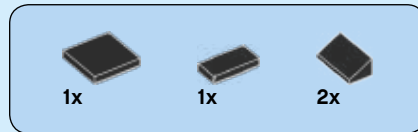
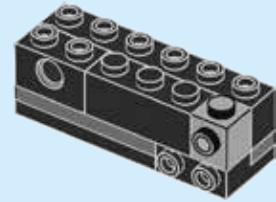

# 25

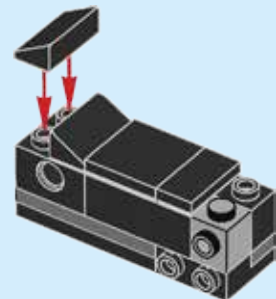



1x

# 26

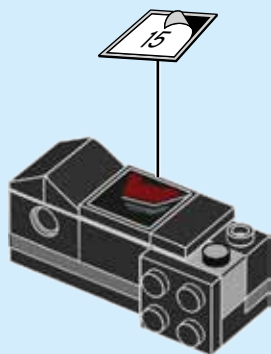

1x



2x



1x

# 27

1

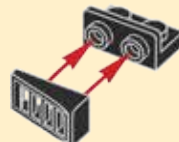

2

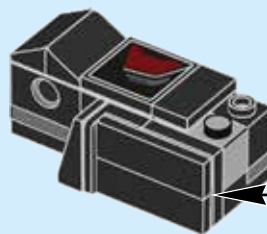

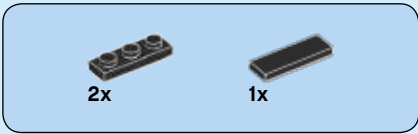

# 28

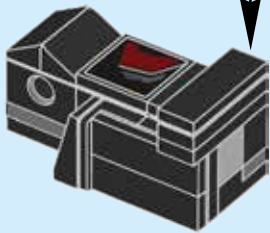
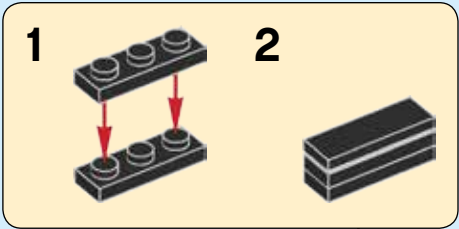

# 29

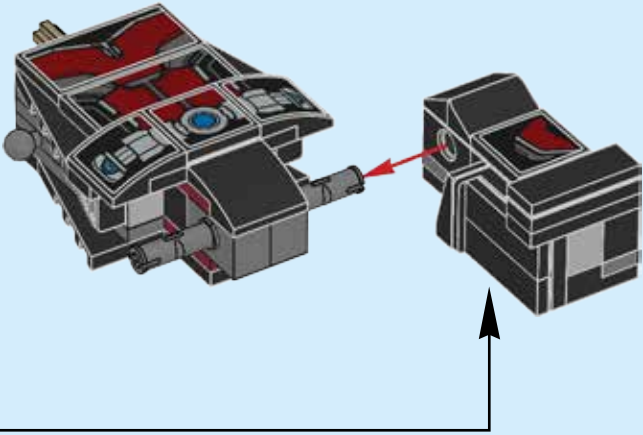



1x

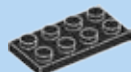

1x

# 30

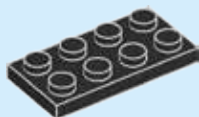

1x



1x

# 31

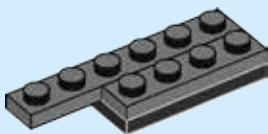

1x

# 32



1x



1x

# 33

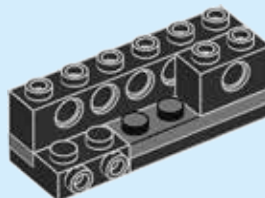



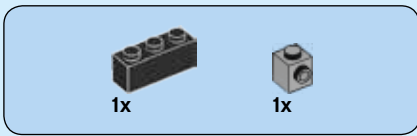

# 34

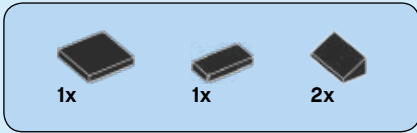
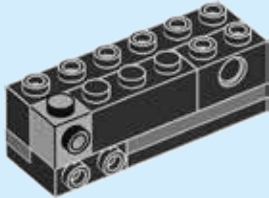

# 35

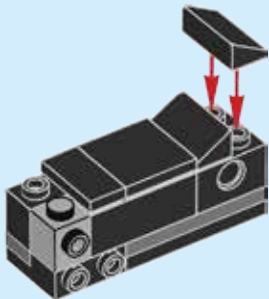

# 36

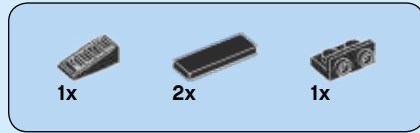
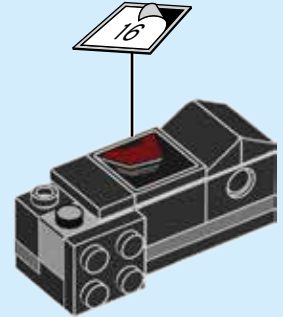

# 37

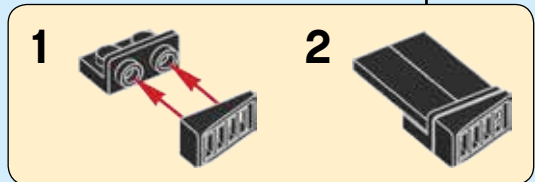
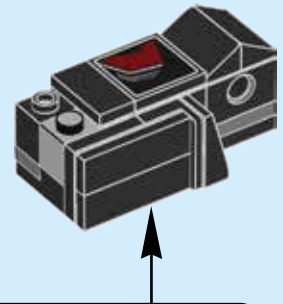

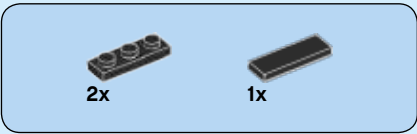

# 38

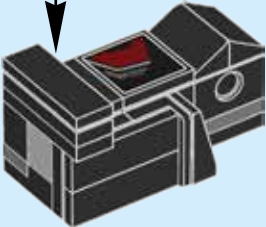
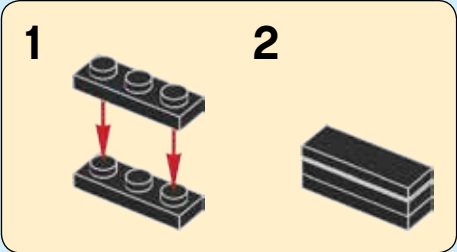

# 39

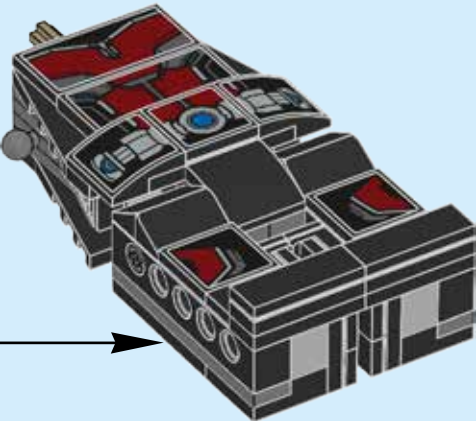

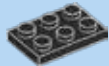

1x

# 40

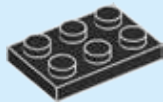

1x

# 41

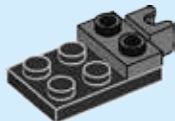

1x



1x

# 42

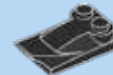
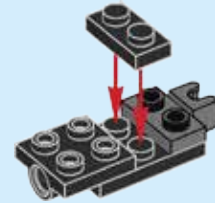

1x



1x

# 43

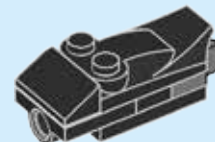



# 44

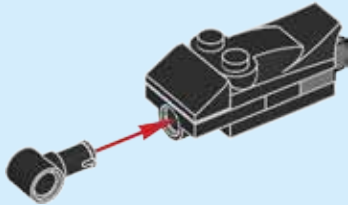

# 45

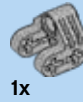
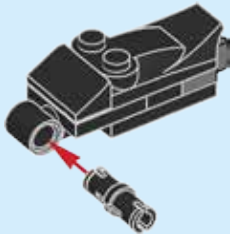

# 46

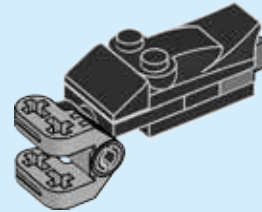

# 47

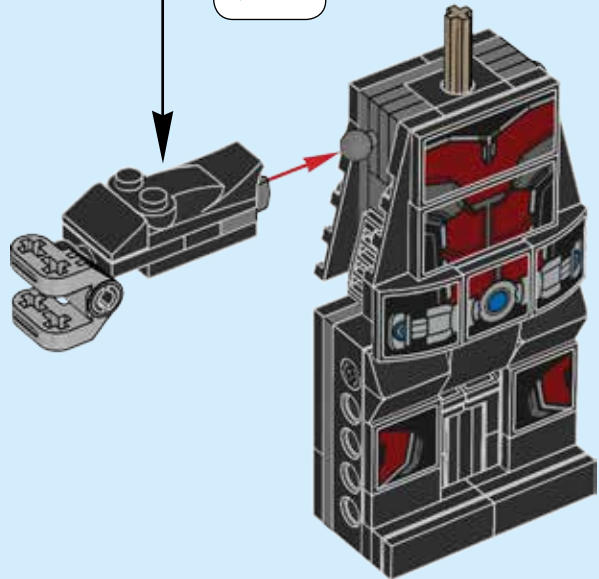
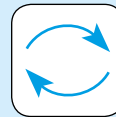

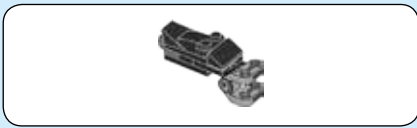

48

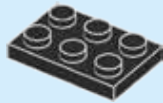

49

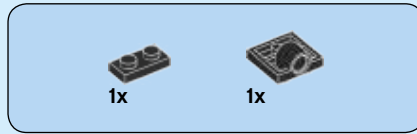

50

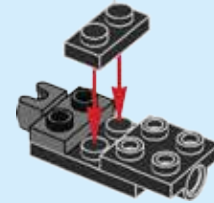

51

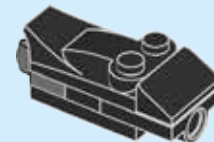



1x

# 52

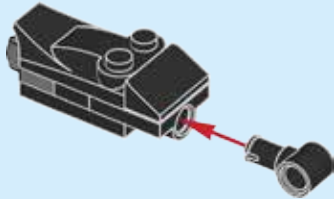

1x

# 53

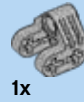
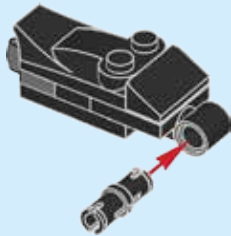

1x

# 54

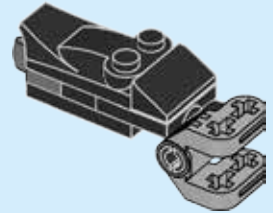

# 55

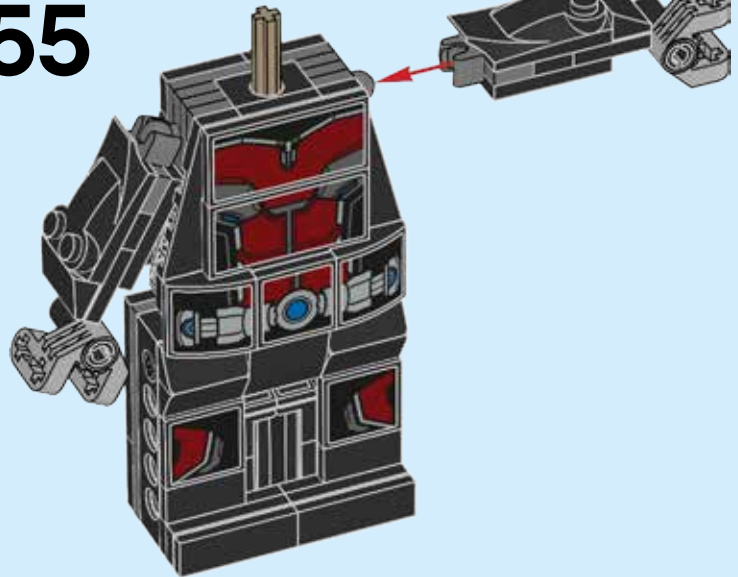



**56**

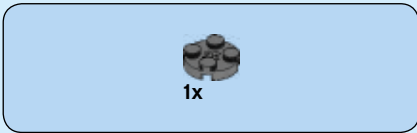
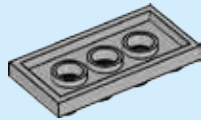

**57**

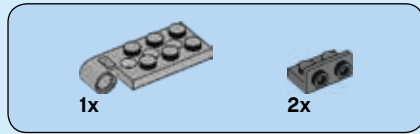
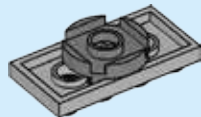

**58**

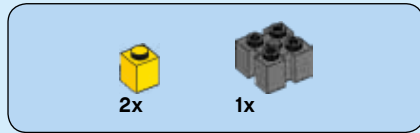
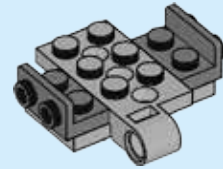
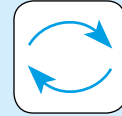

**59**

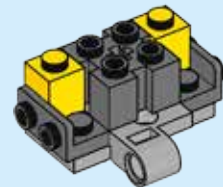

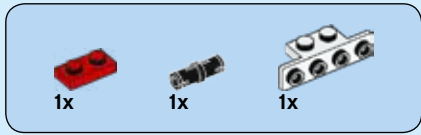

60

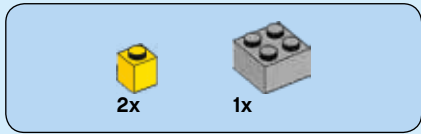
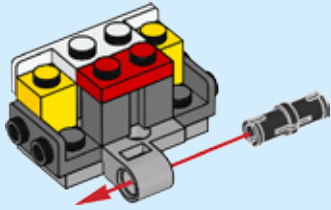

61

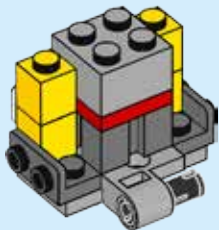

62

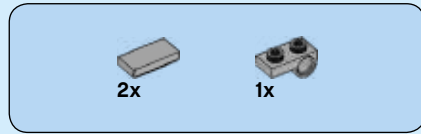
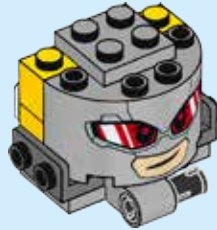

63

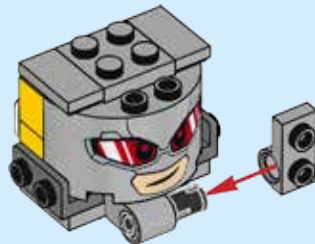





2x

# 64

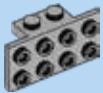
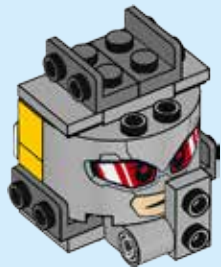

1x

# 65

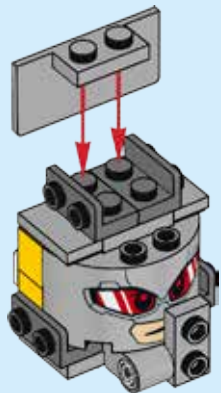

2x

# 66

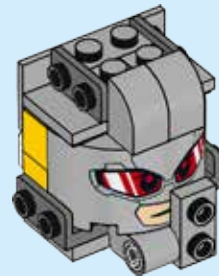

1x



2x

# 67

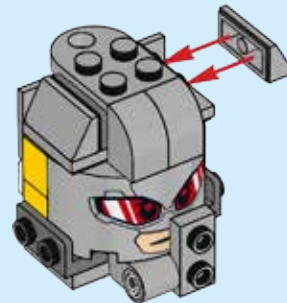



# 68

1

2

3

4

Two circular arrows icons are shown above step 3 and above step 4.

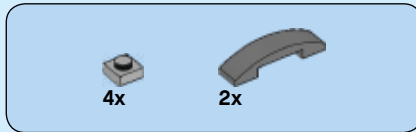
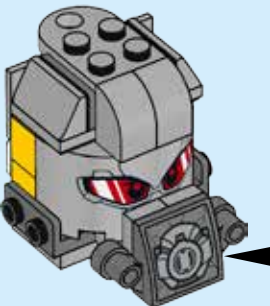

# 69

1

2

2x

A red arrow points from part 1 to part 2.

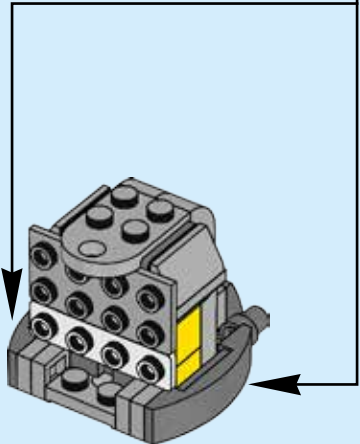
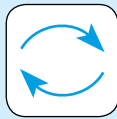



# 70

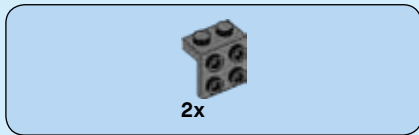
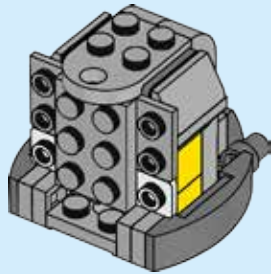

# 71

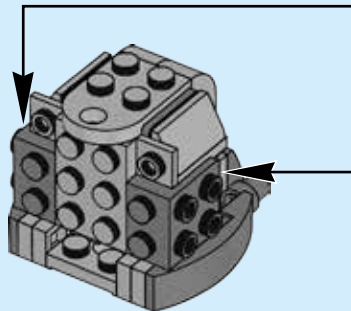

# 72

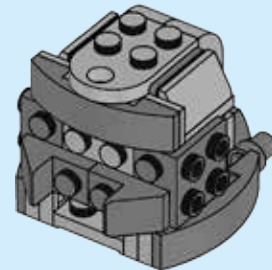

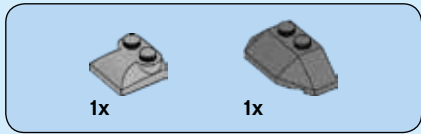

# 73

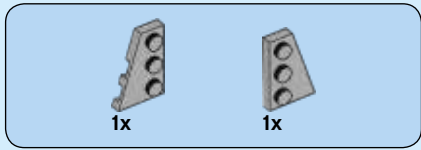
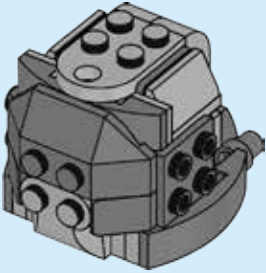

# 74

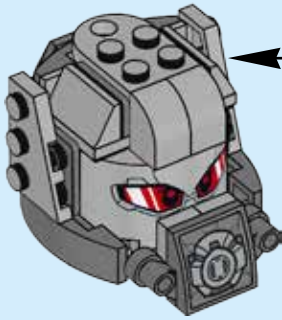
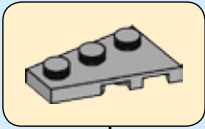
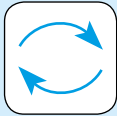

75

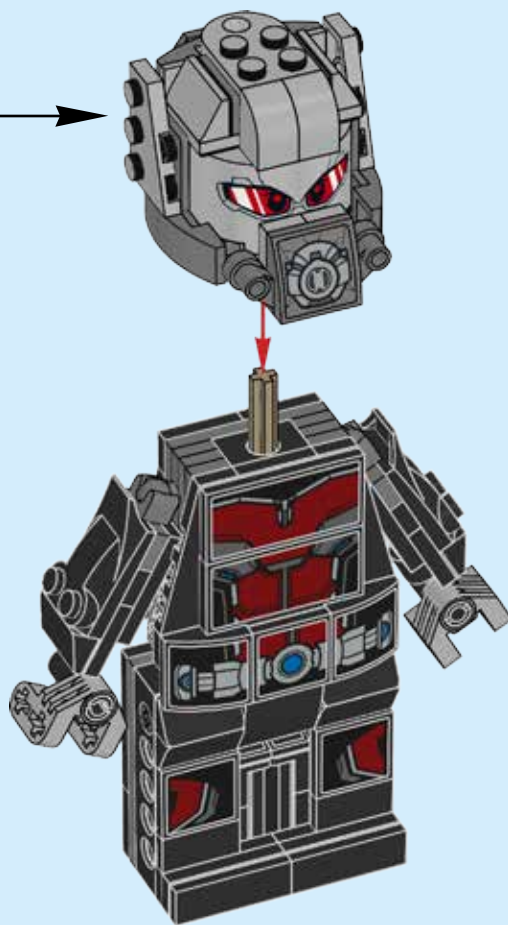

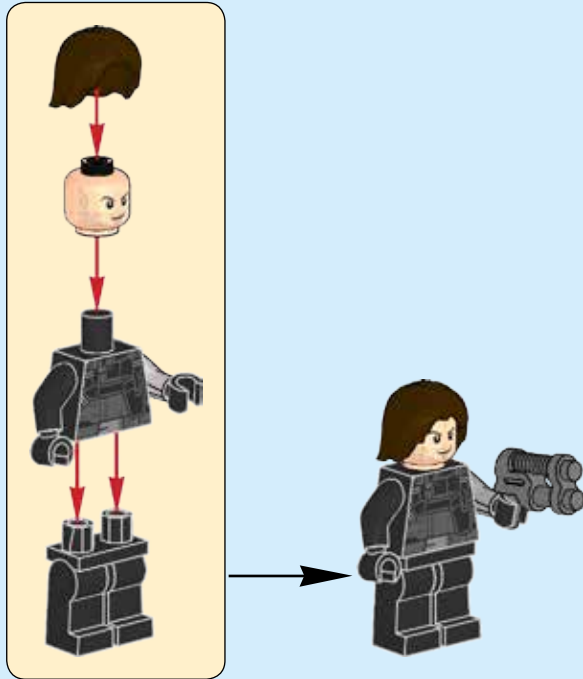
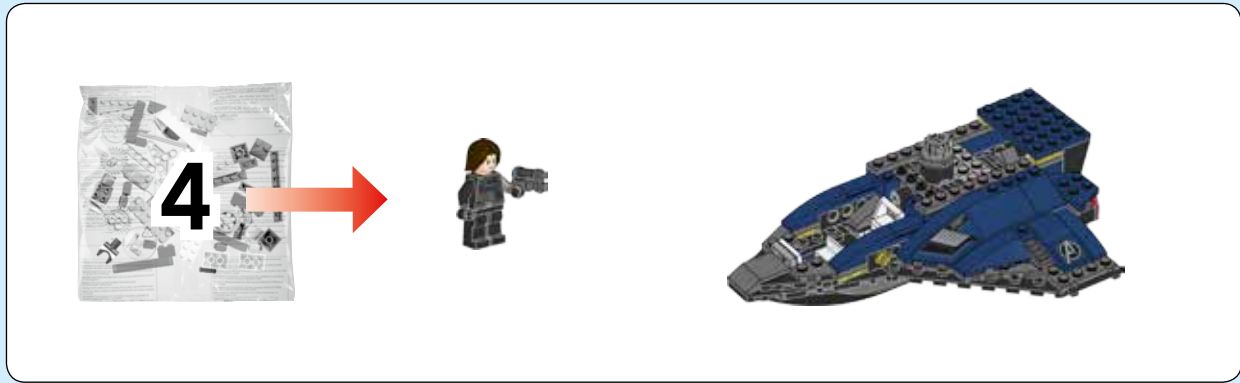

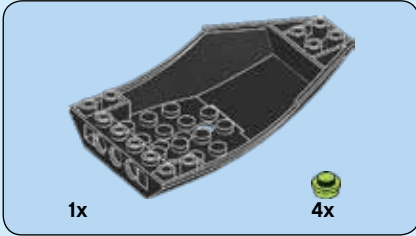

1

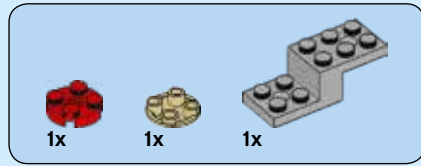
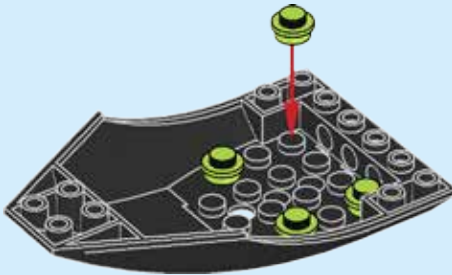

2

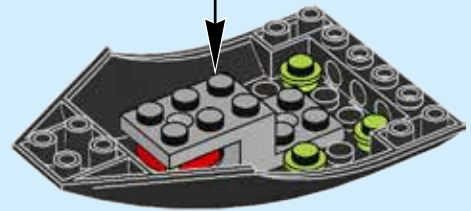



2x

3

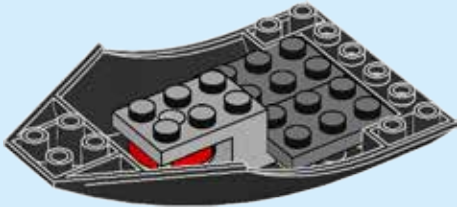

2x

4

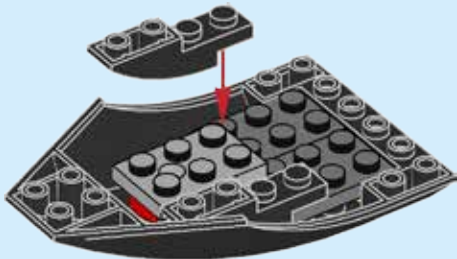

2x

5

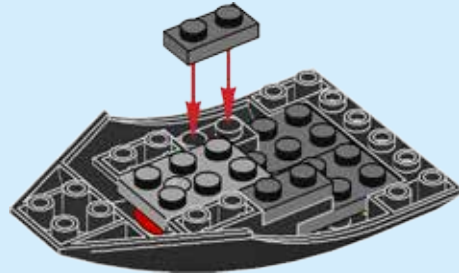

2x

6

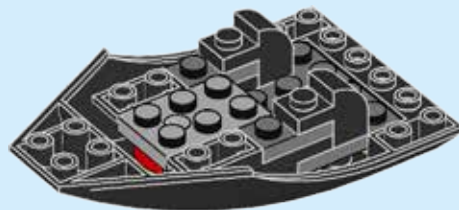



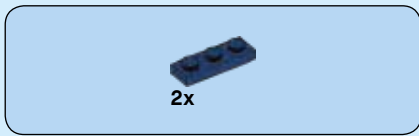

7

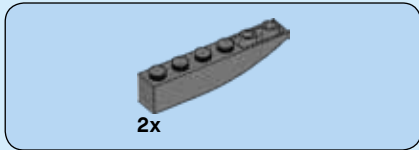
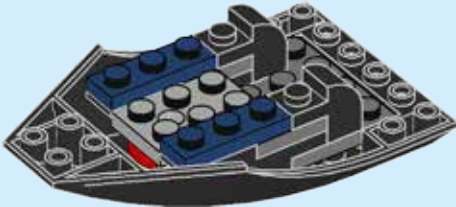

8

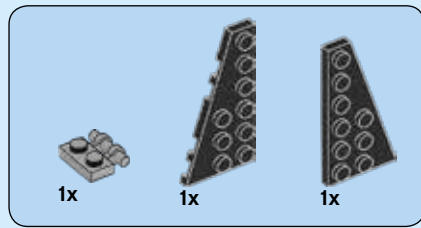
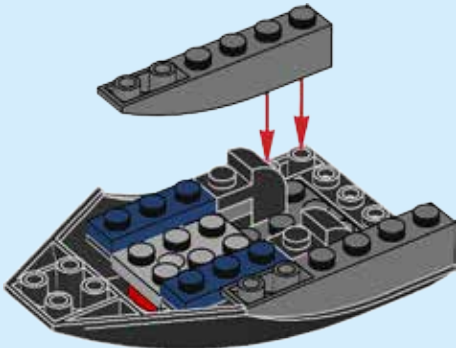

9

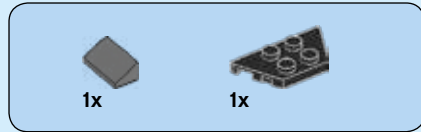
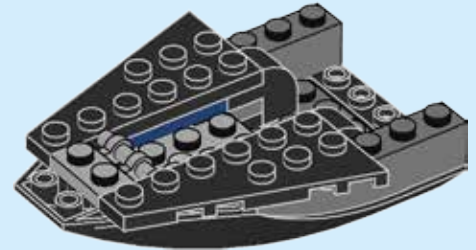

10

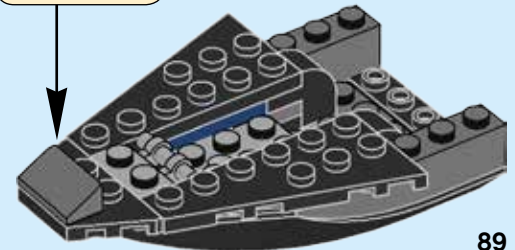
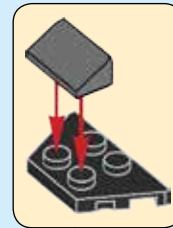

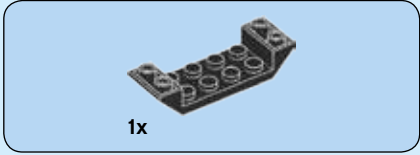
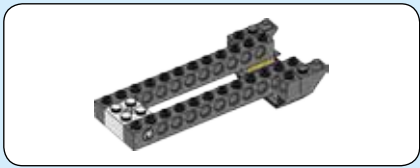

1x

# 11

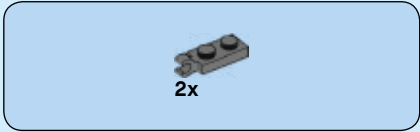
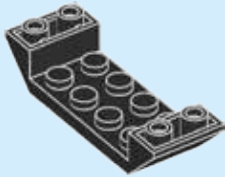

2x

# 12

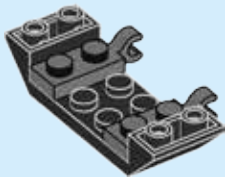

2x

# 13

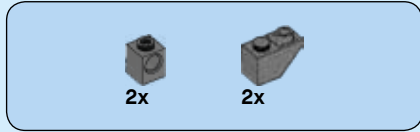
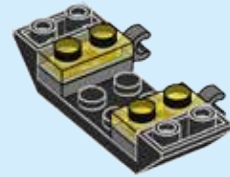

2x

2x

# 14

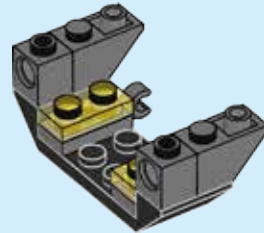

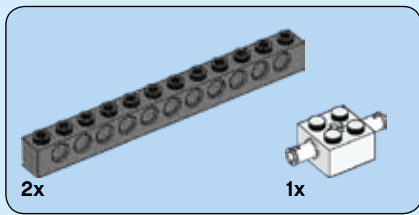

# 15

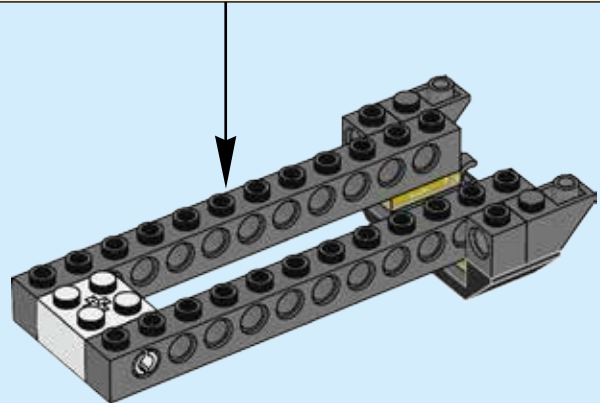
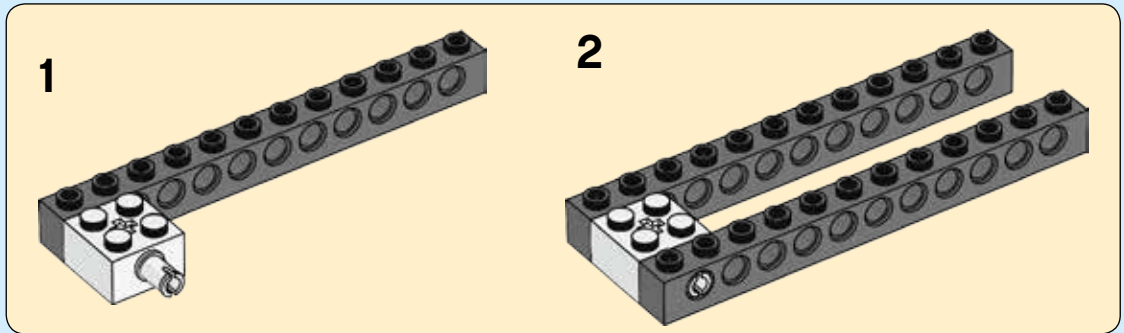

# 16

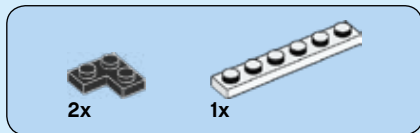
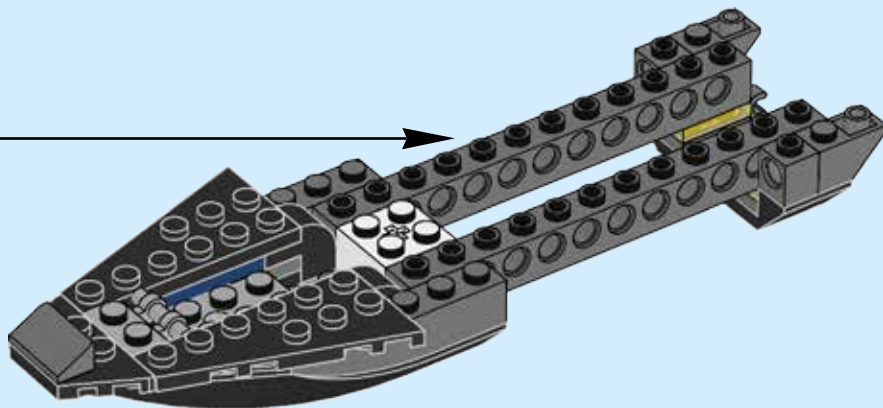

# 17

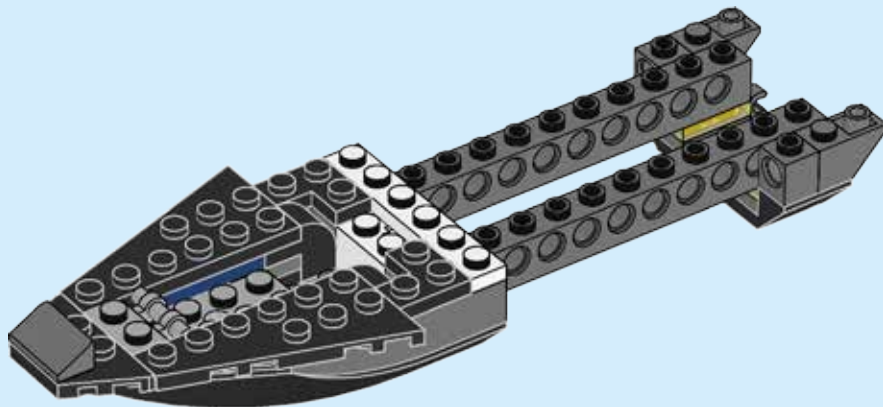



18

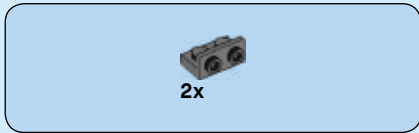
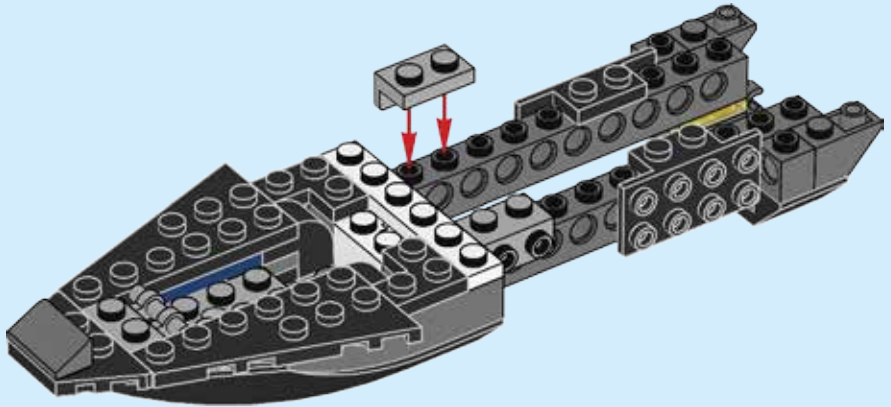

19

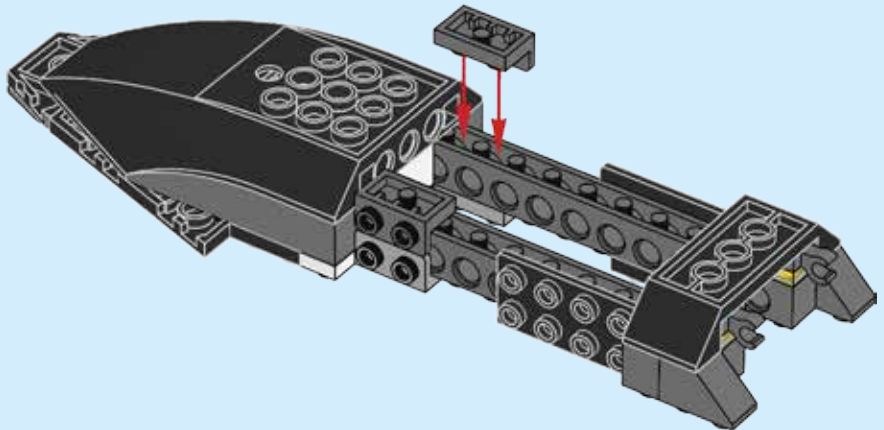
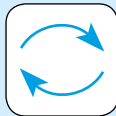



# 20

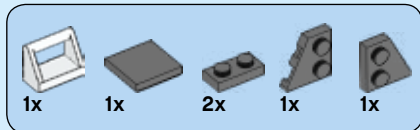
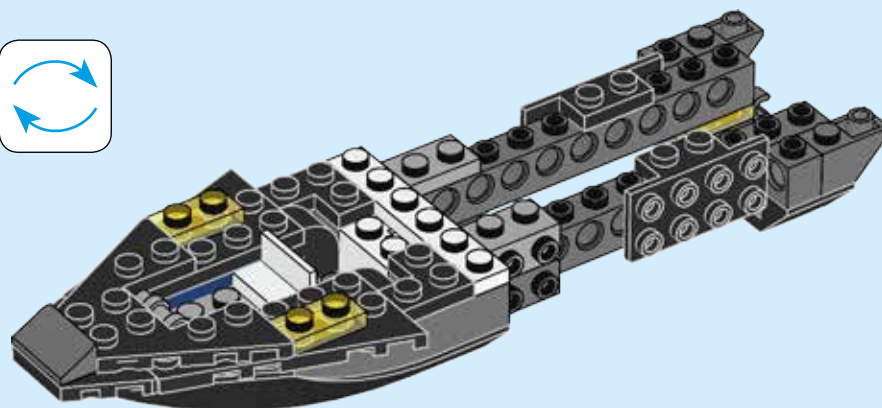
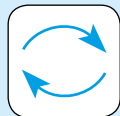

# 21

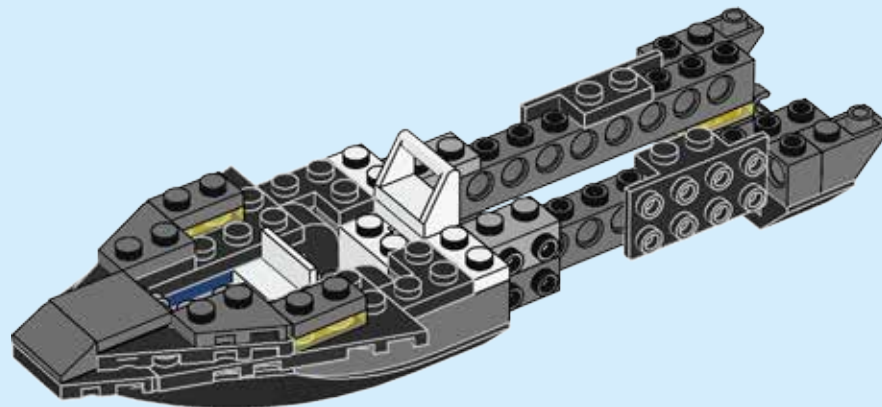

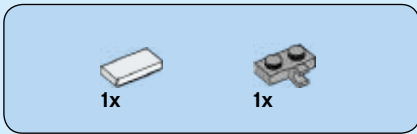

# 22

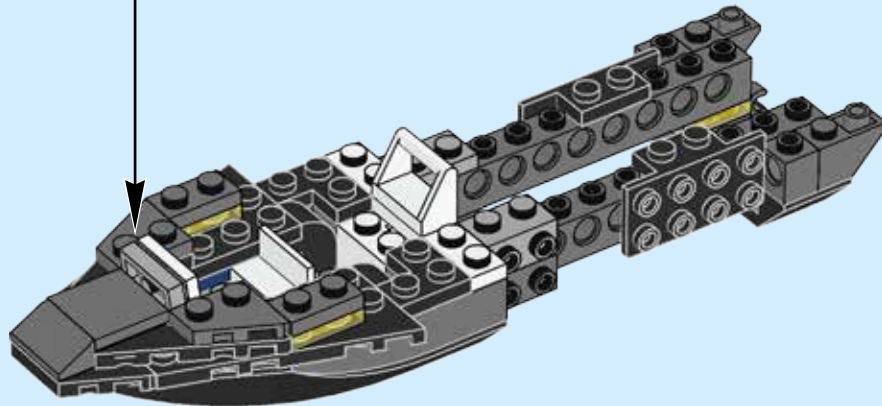
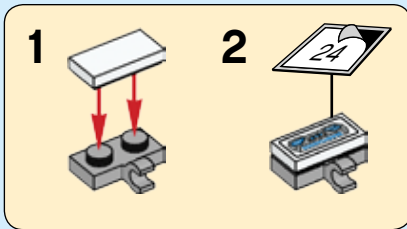



2x



2x

# 23

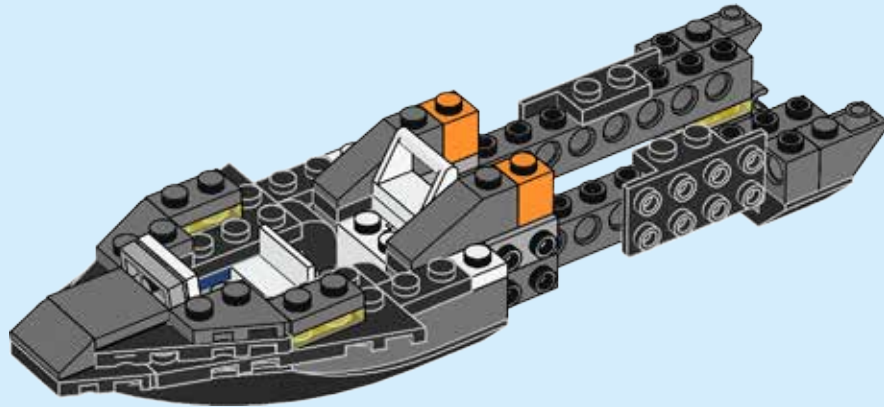

4x

# 24

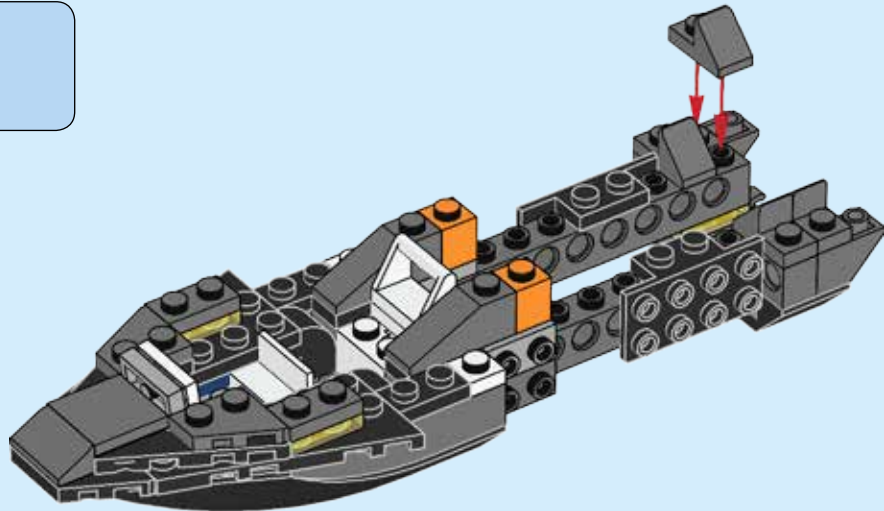



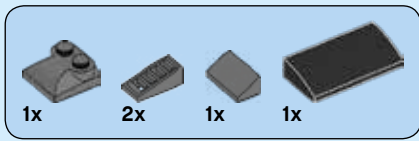

# 25

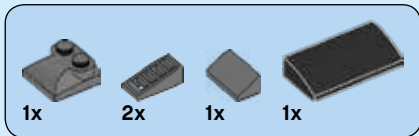
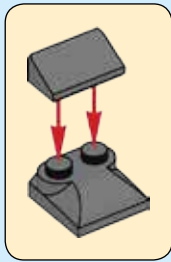
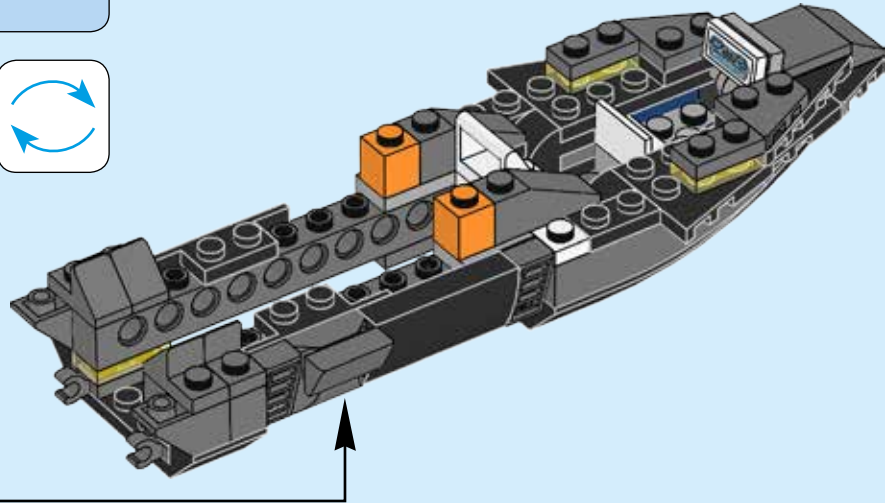
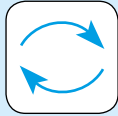

# 26

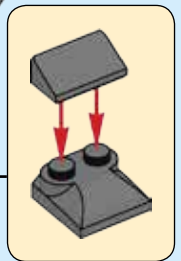
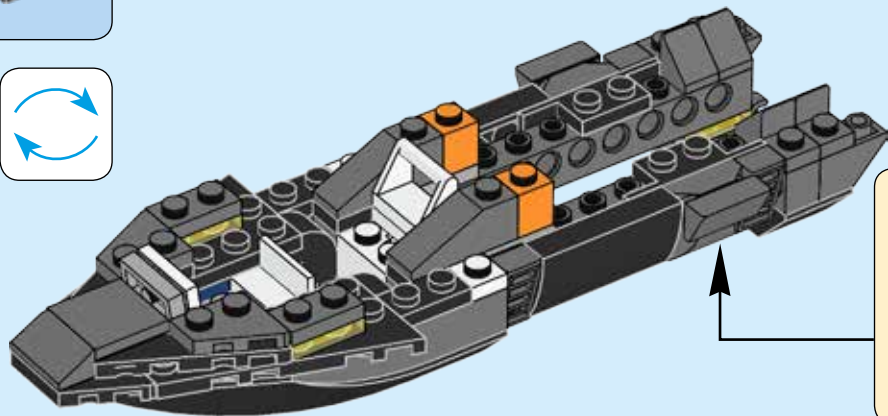
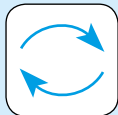

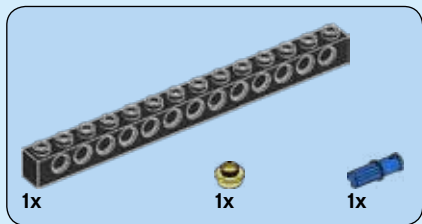

27

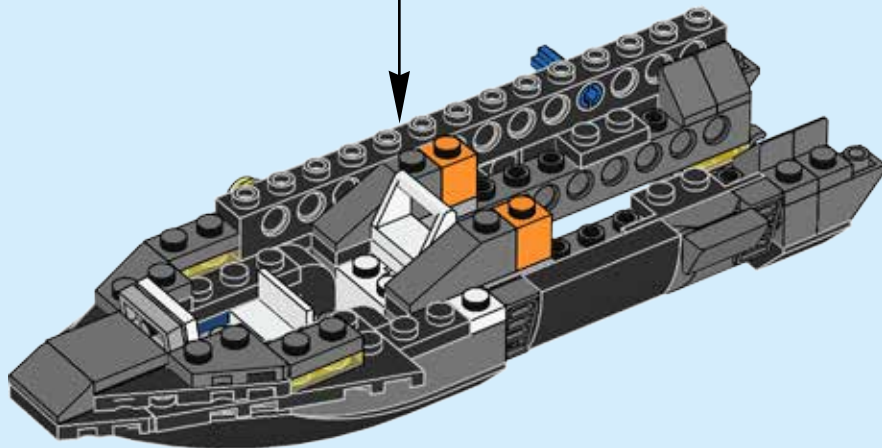
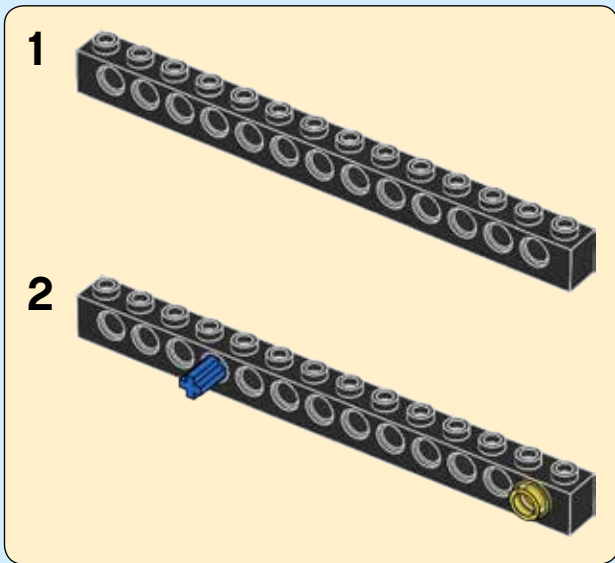

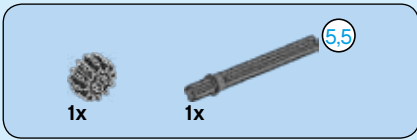

28

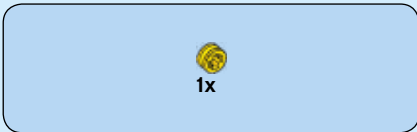
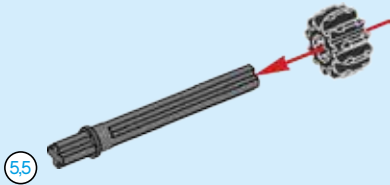

29

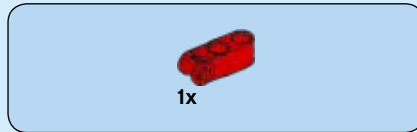
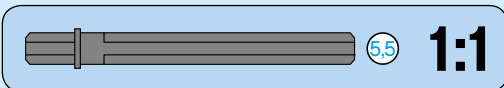
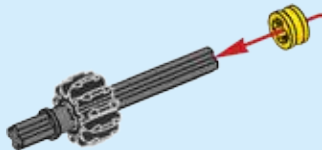

30

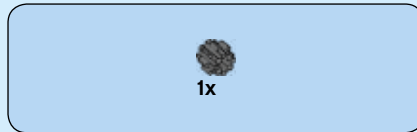
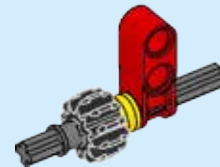

31

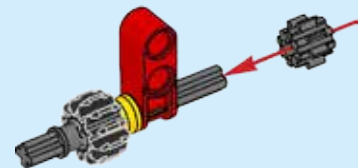



2x

# 32

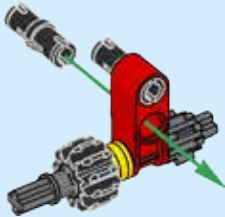

1x

# 33

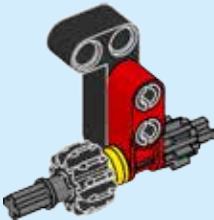

2x

# 34

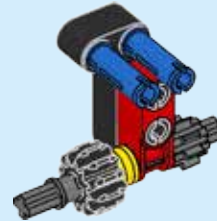

1x



1x

# 35

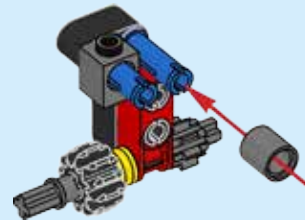

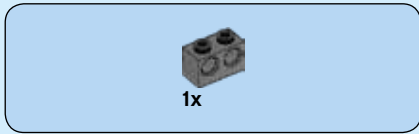

# 36

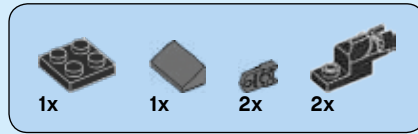
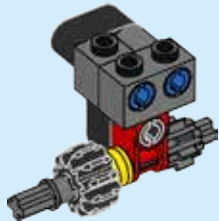

# 37

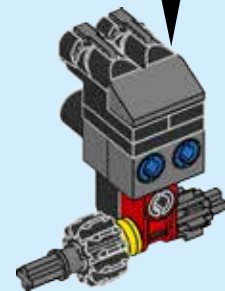
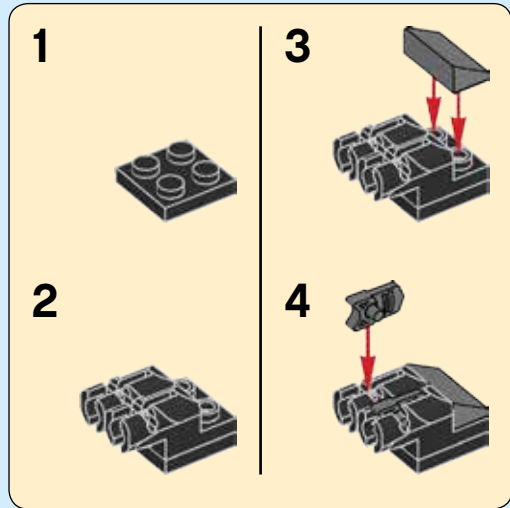

# 38

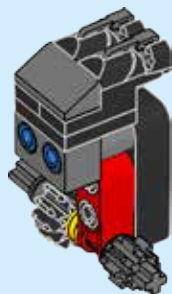
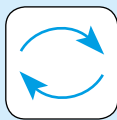

---

# 39

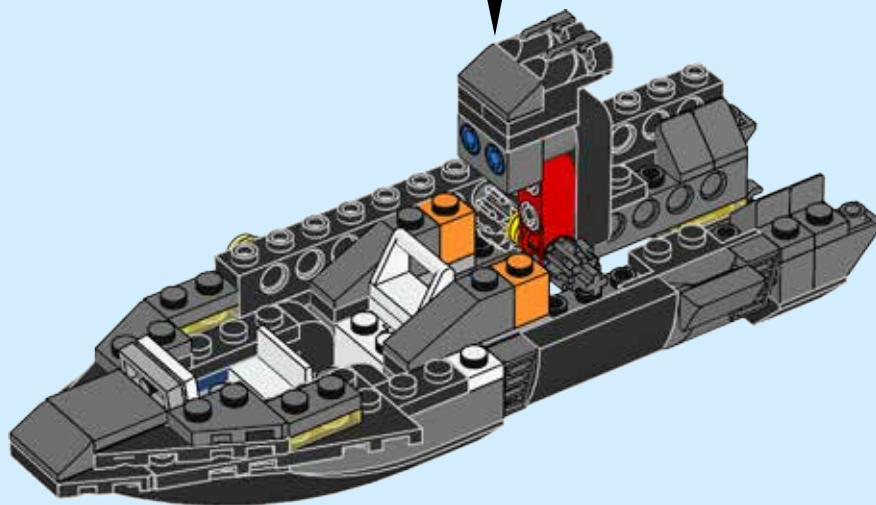

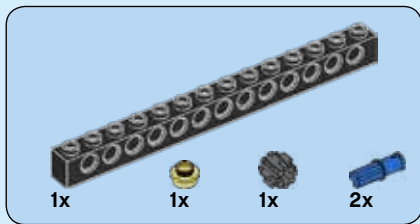

# 40

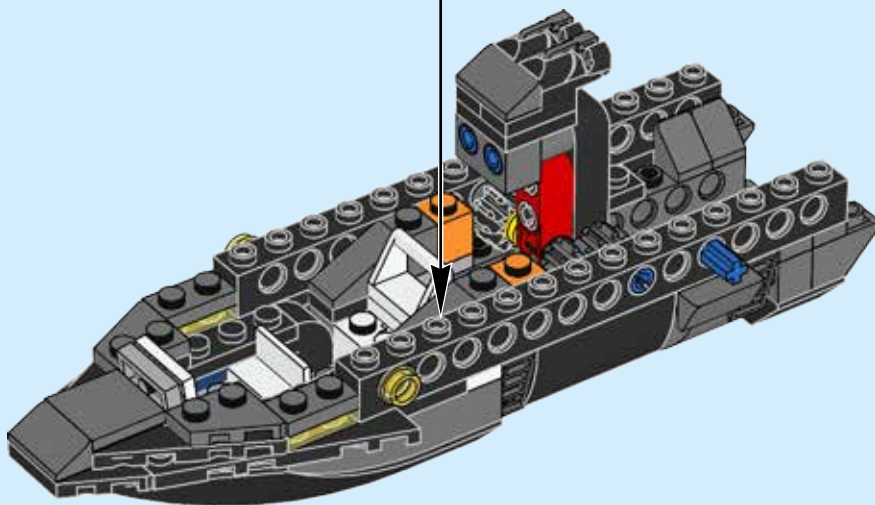
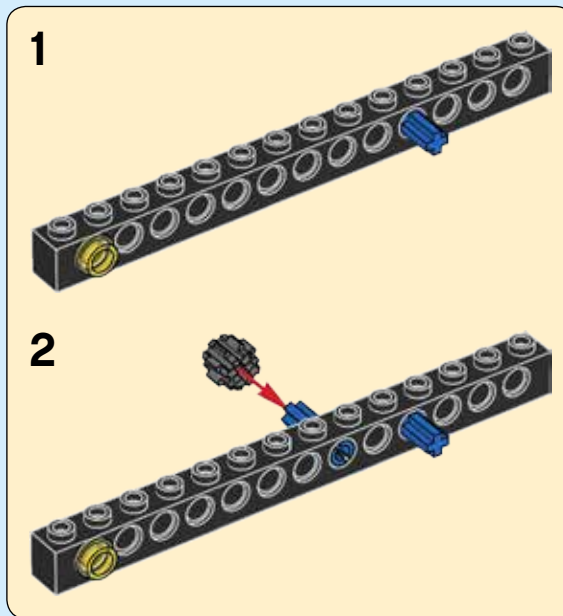

# 41

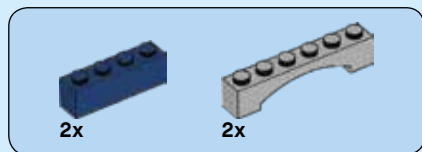
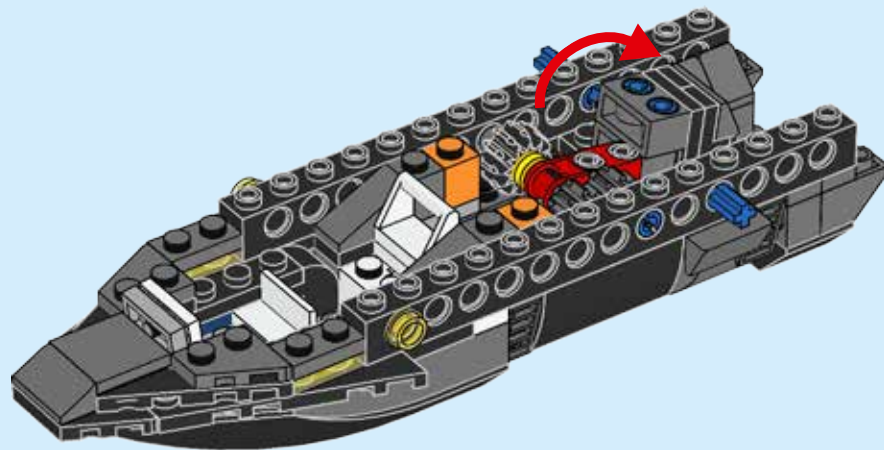

# 42

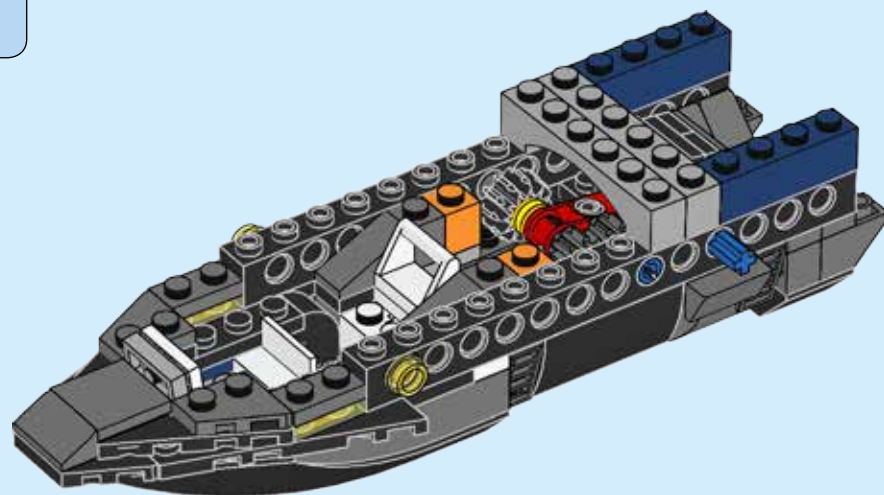





2x

# 43

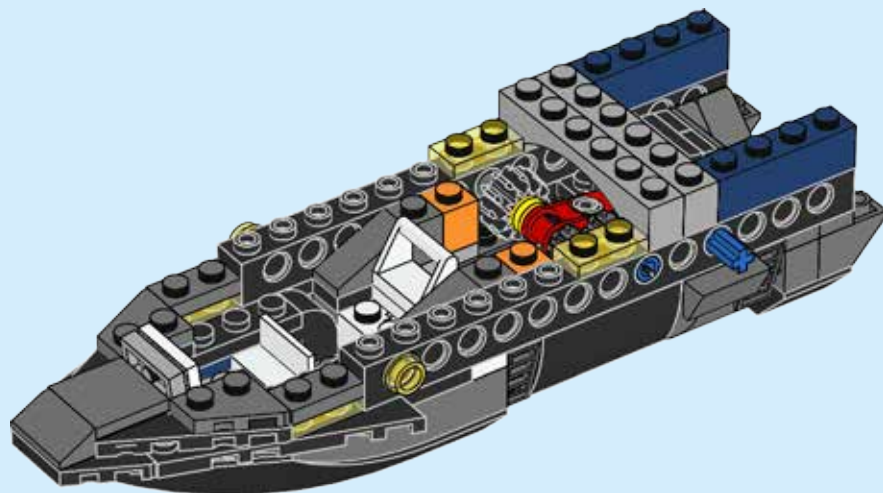

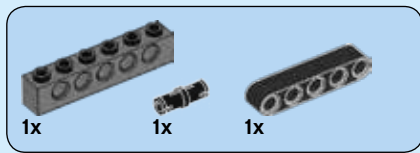

# 44

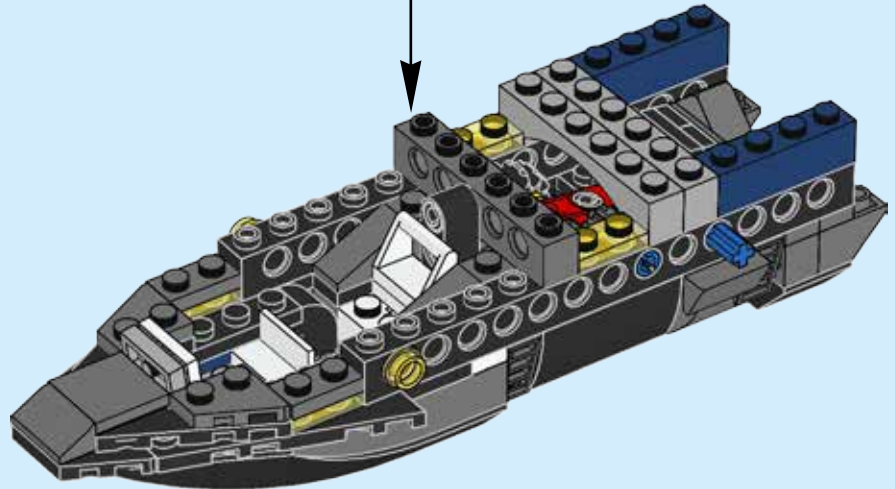
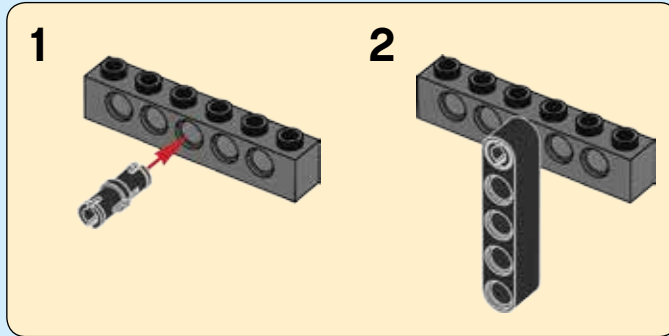

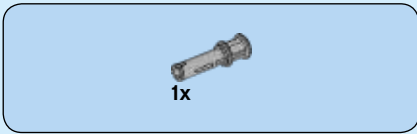

# 45

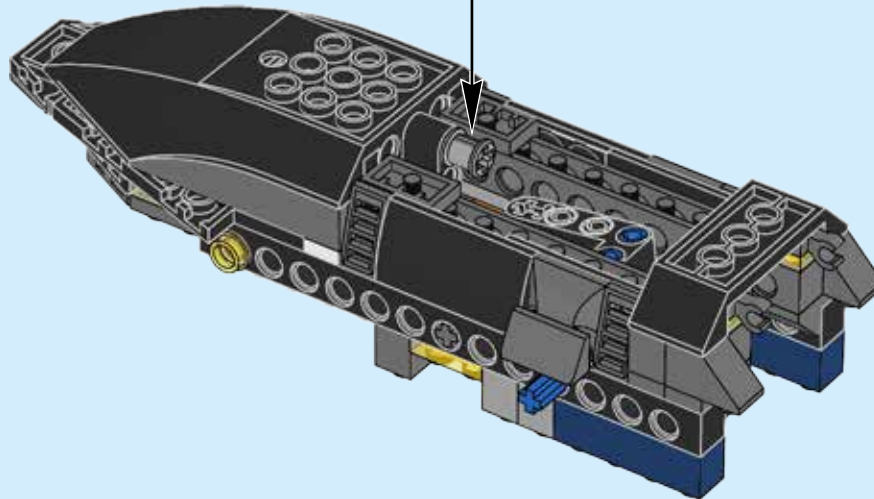
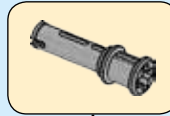
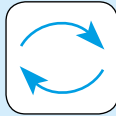



2x



2x

# 46

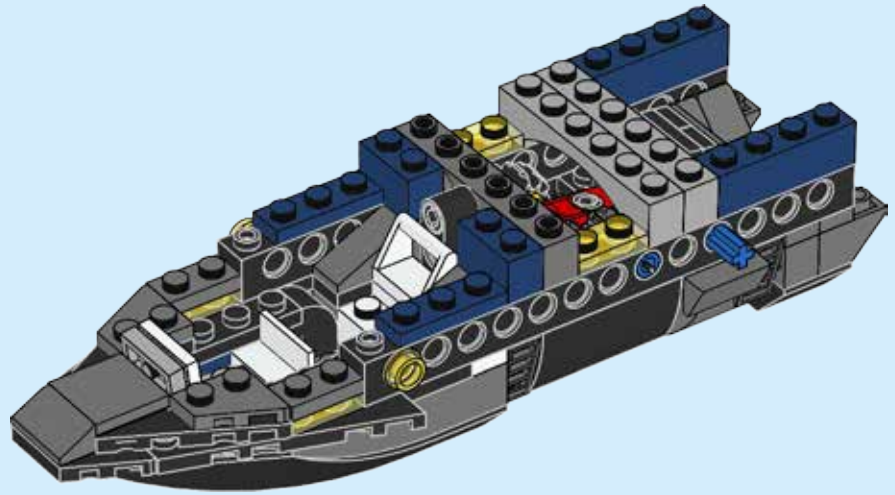
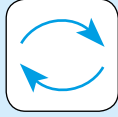

2x



2x

# 47

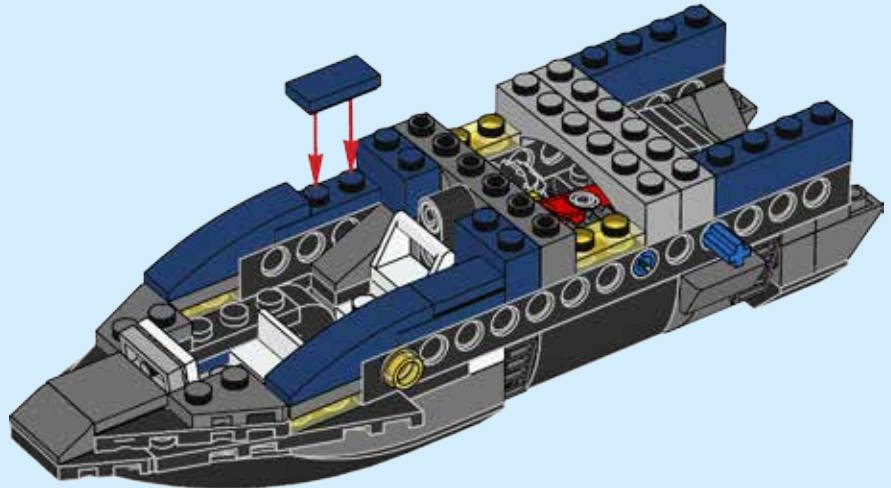

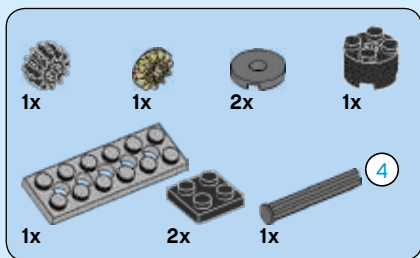

# 48

## 1

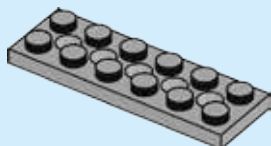

## 2

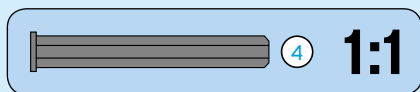
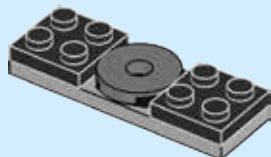

## 3

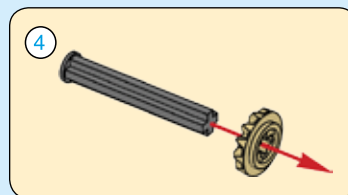
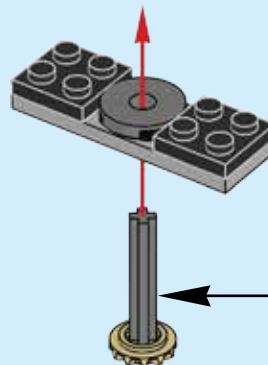

## 4

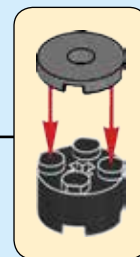
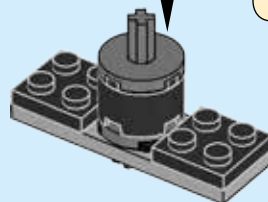

5

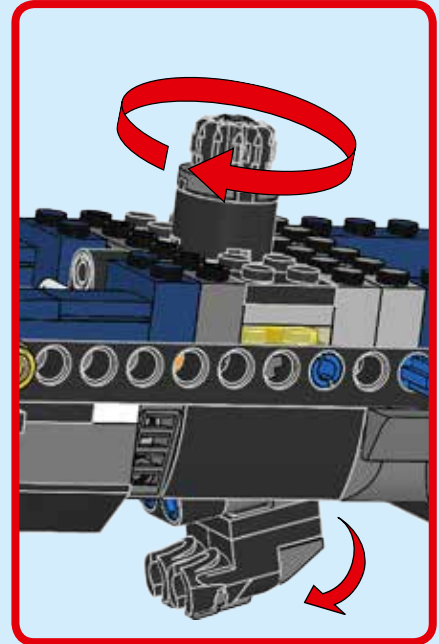
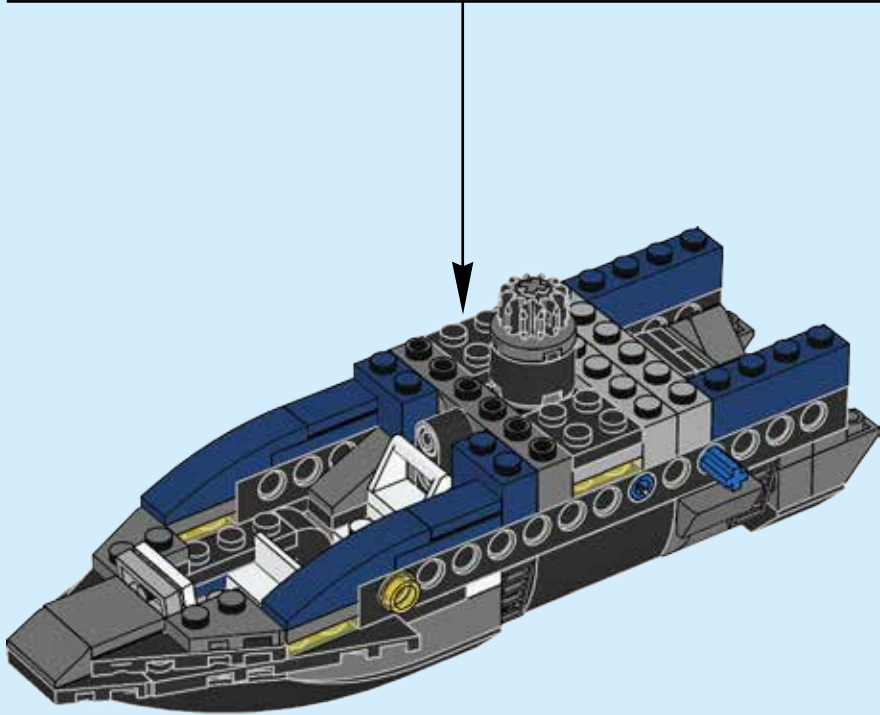
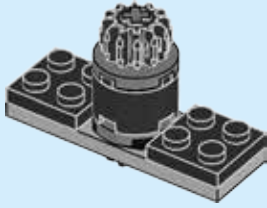



2x

# 49

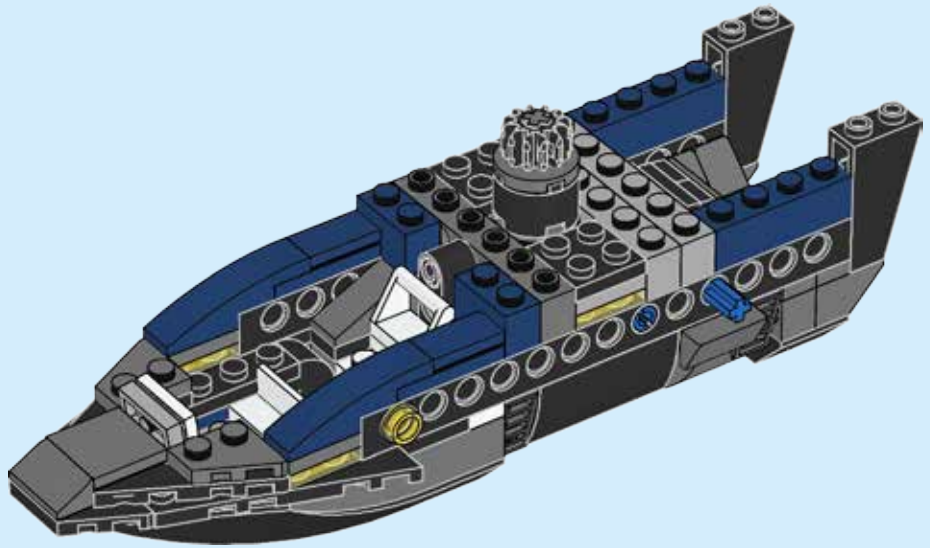

2x

# 50

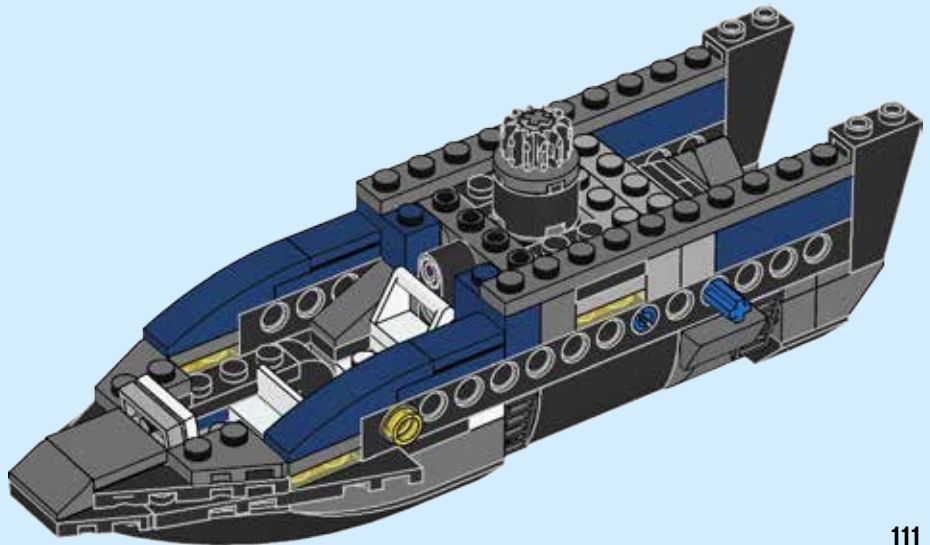



2x

# 51

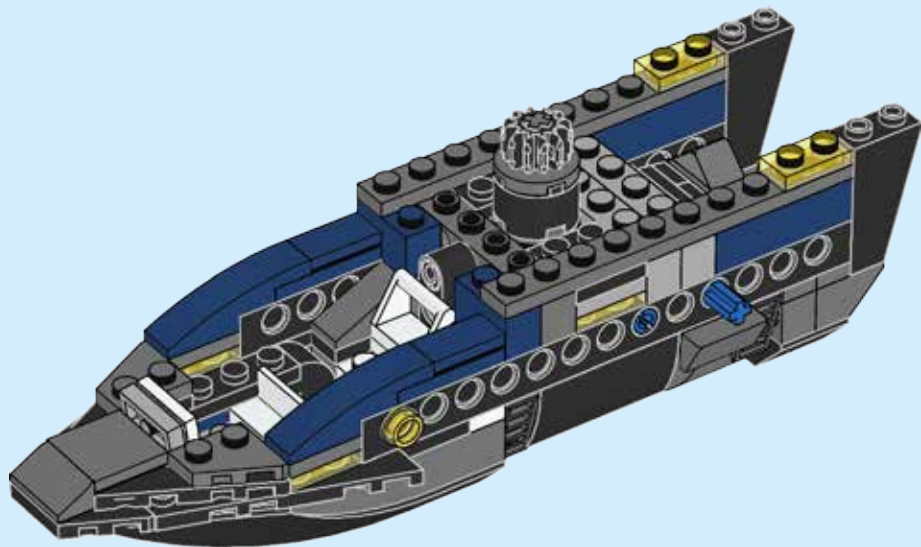

1x

# 52

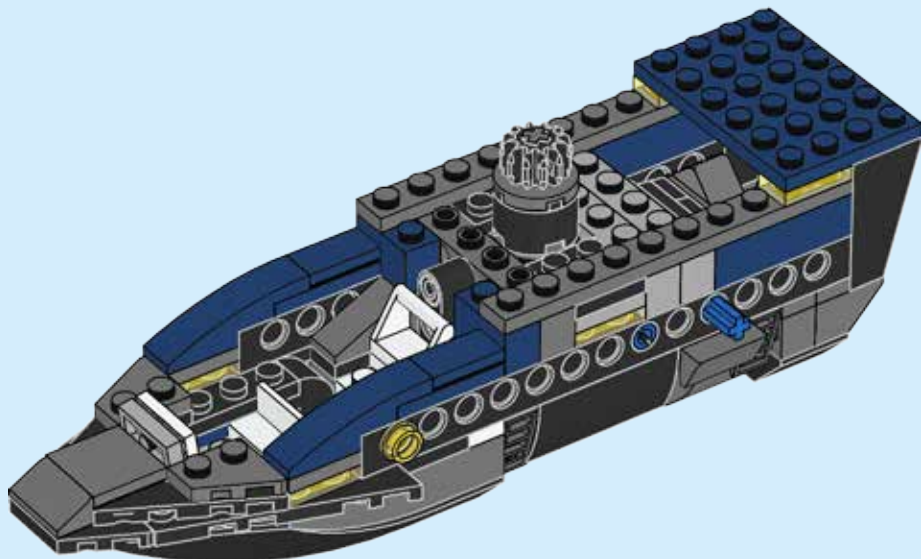





2x

# 53

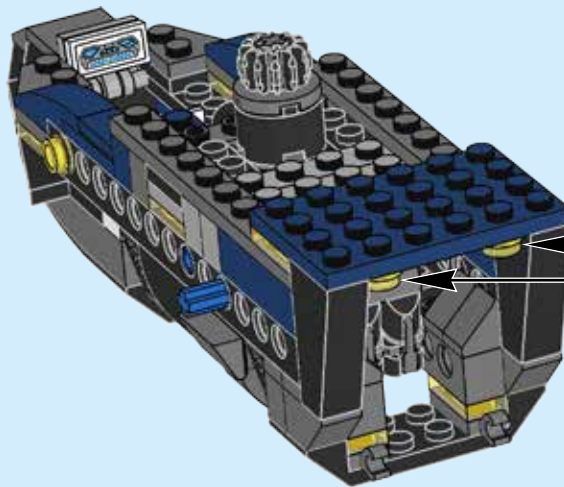
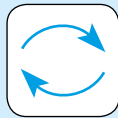

2x

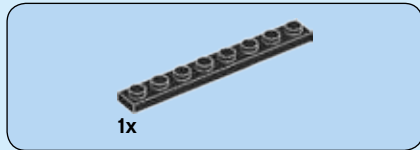

**54**

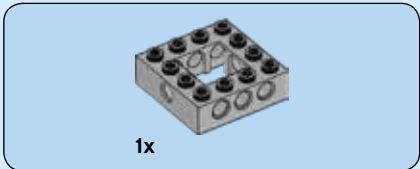
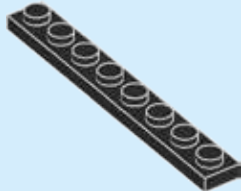

**55**

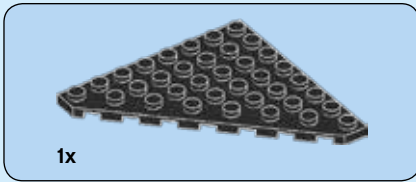
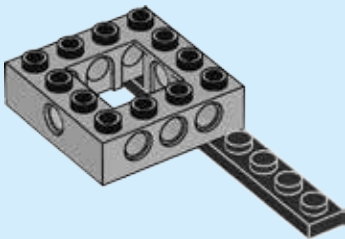

**56**

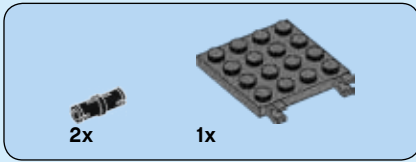
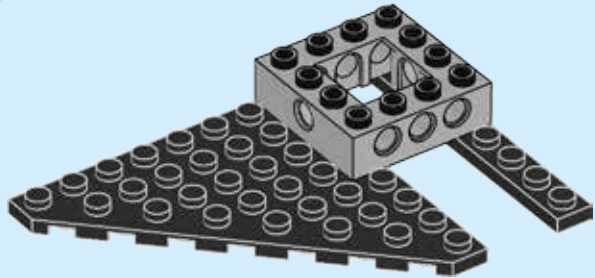

**57**

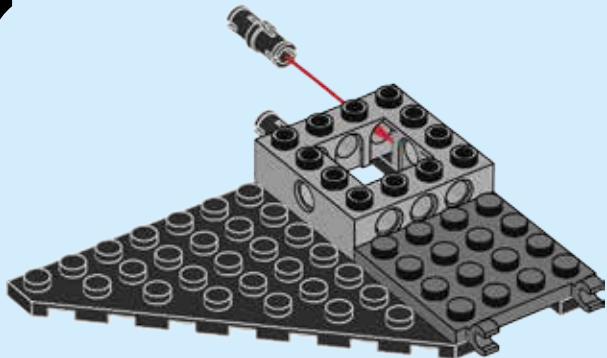

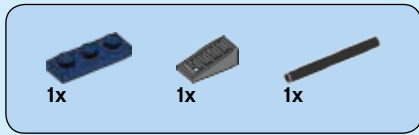

# 58

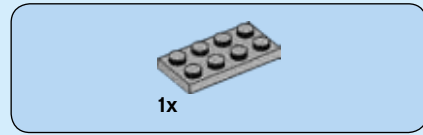
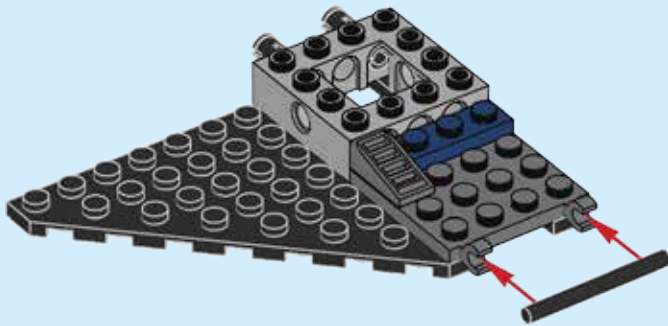

# 59

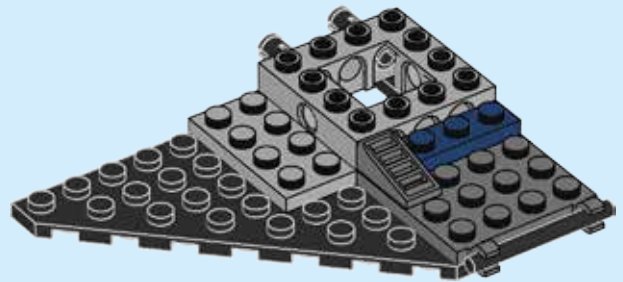



# 60

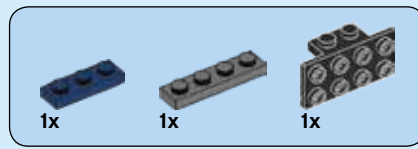
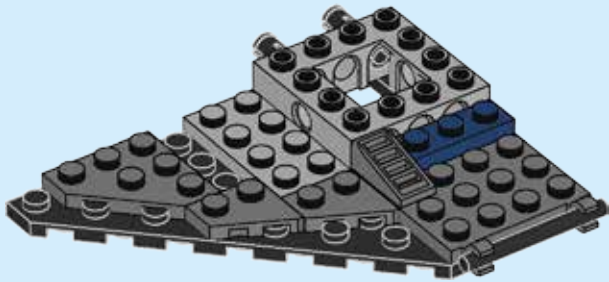

# 61

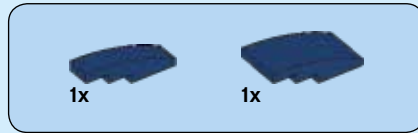
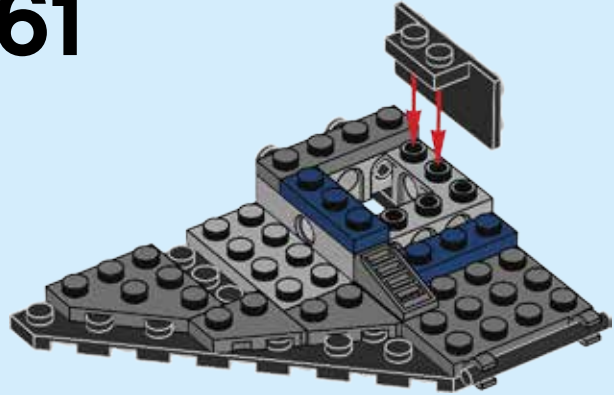

# 62

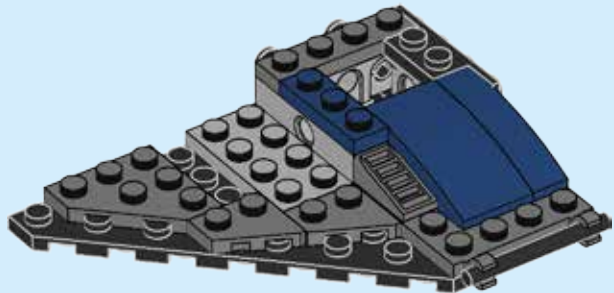

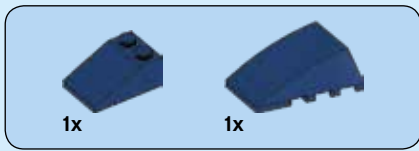

63

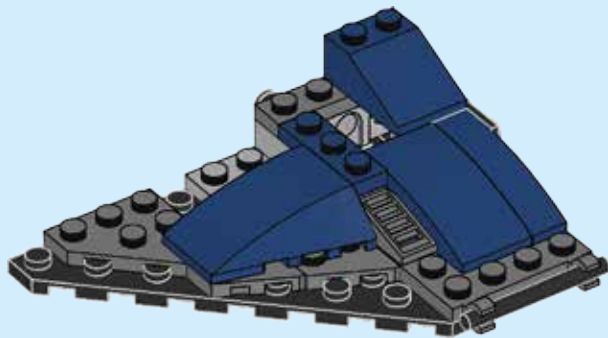

64

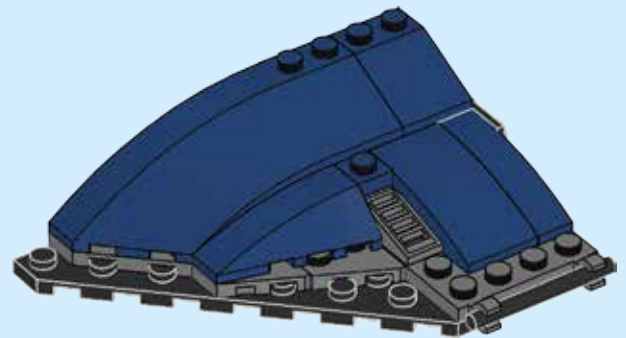

# 65

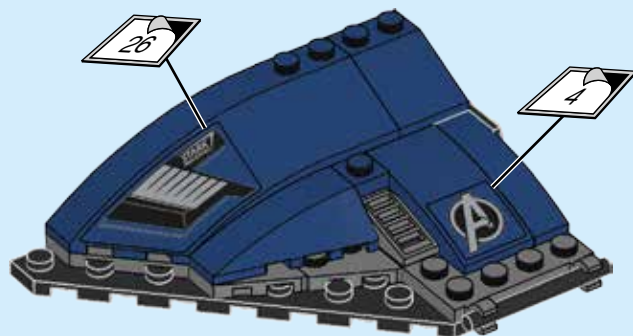

# 66

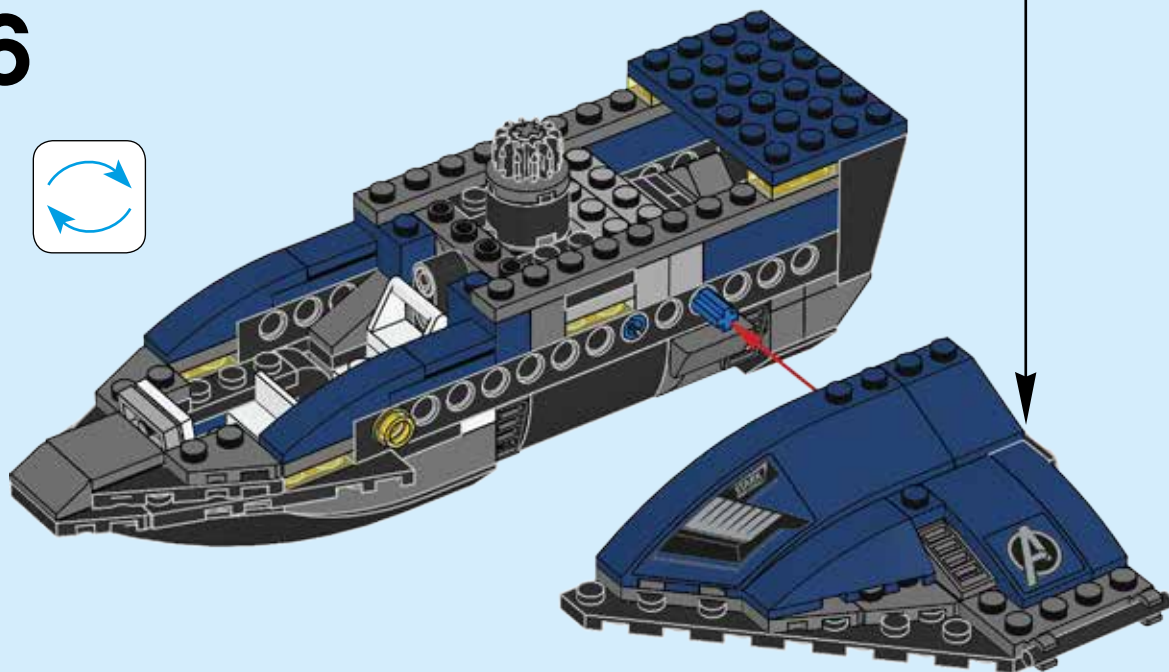
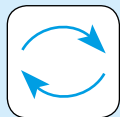



# 67

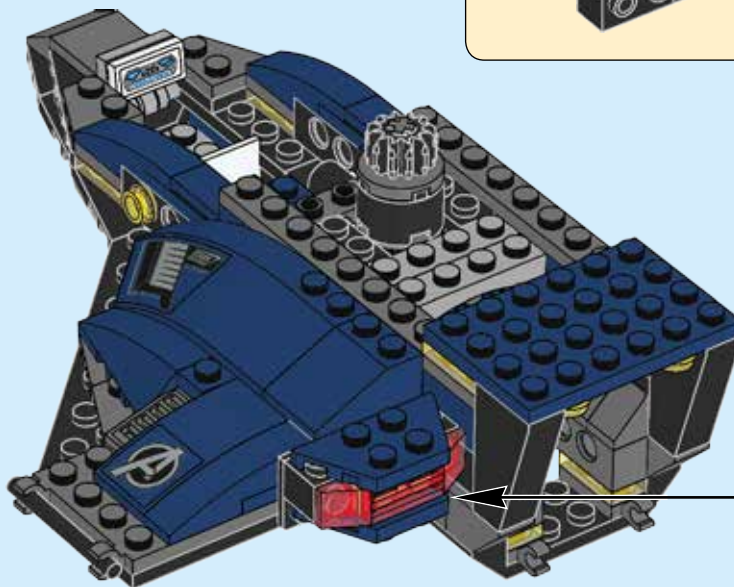
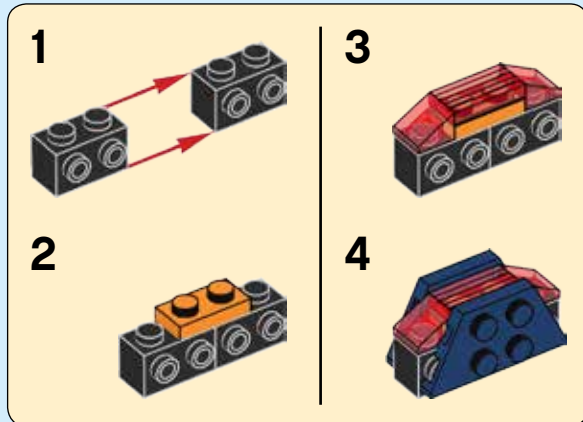
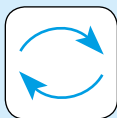

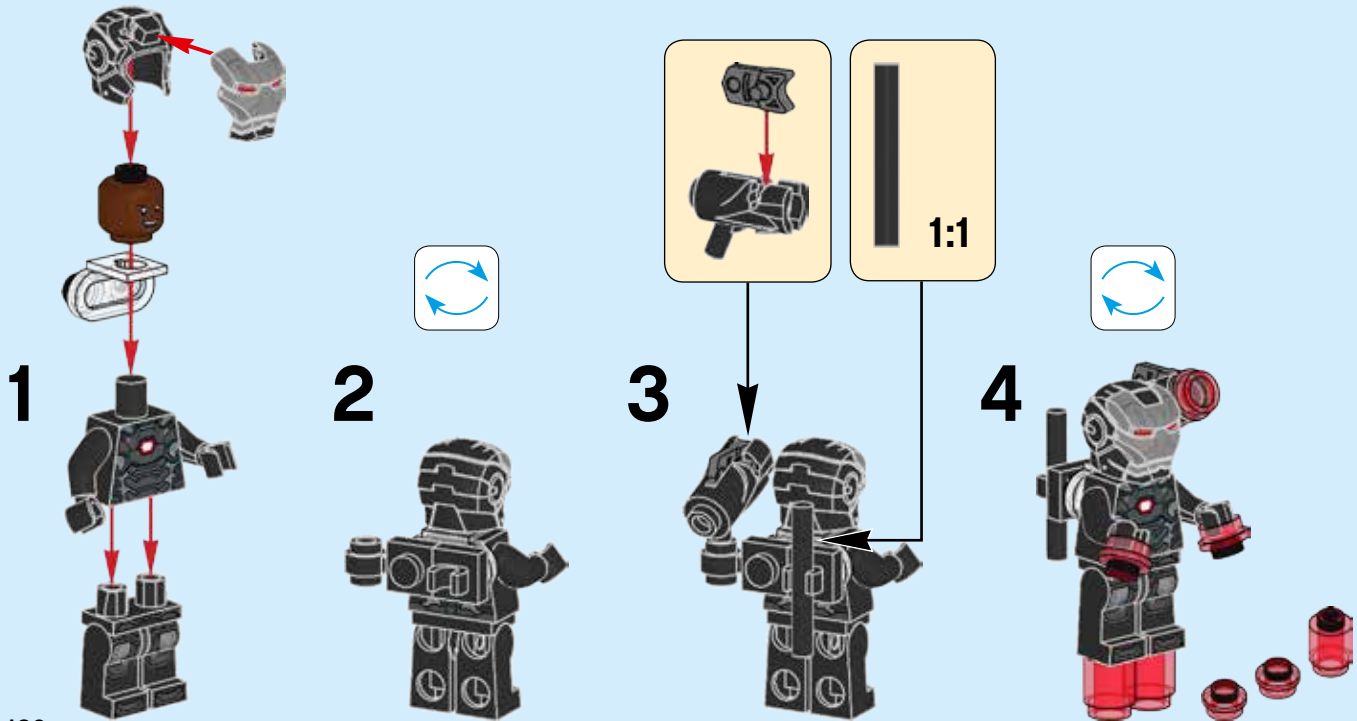
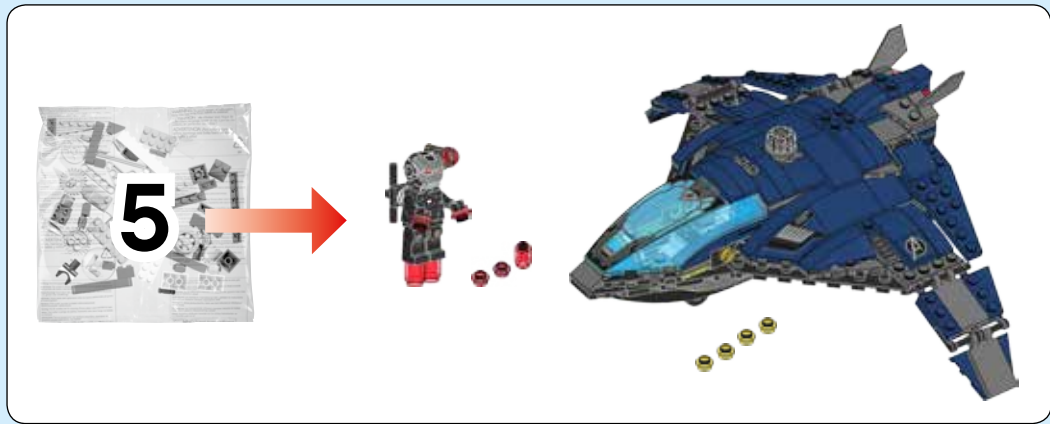



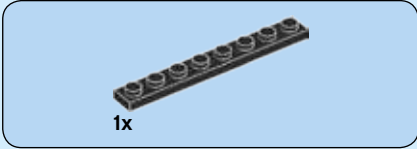

68

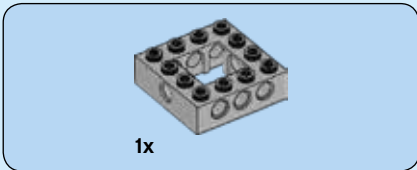
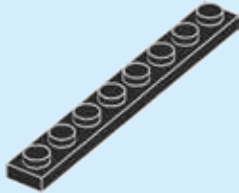

69

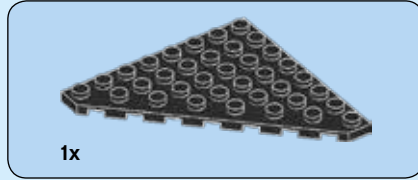
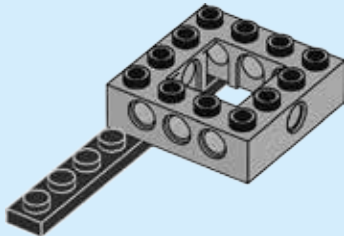

70

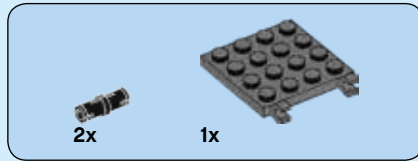
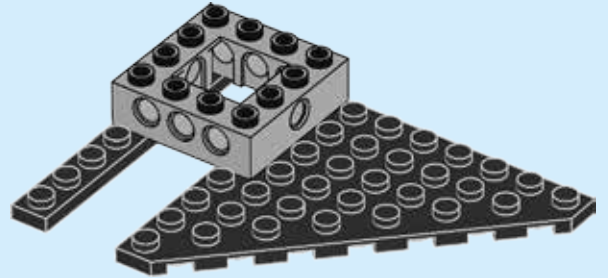

71

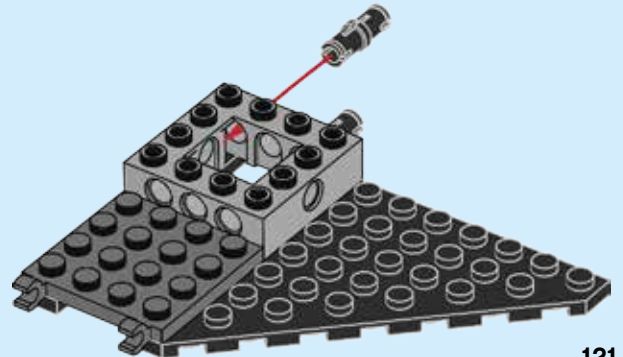

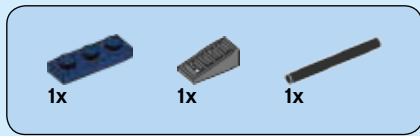

# 72

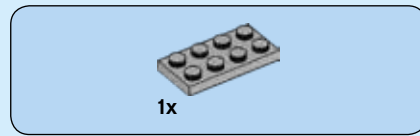
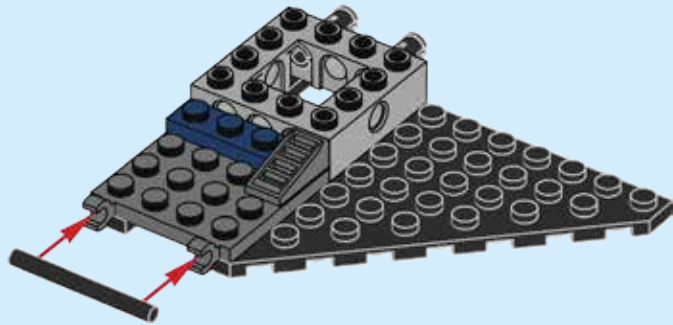

# 73

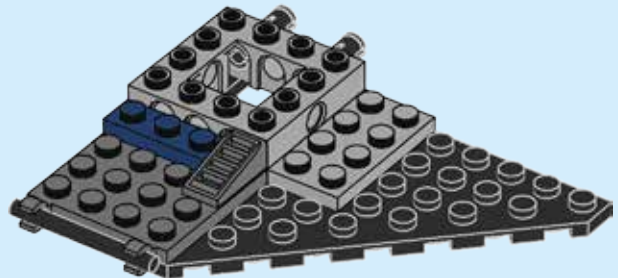



# 74

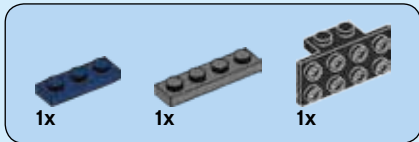
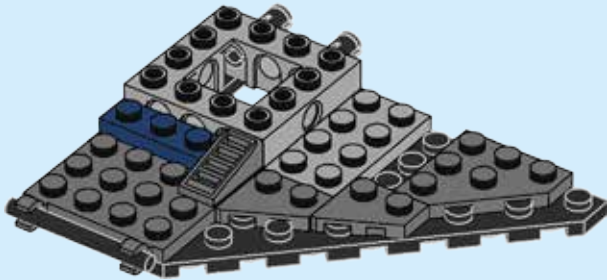

# 75

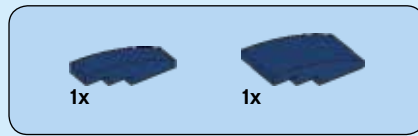
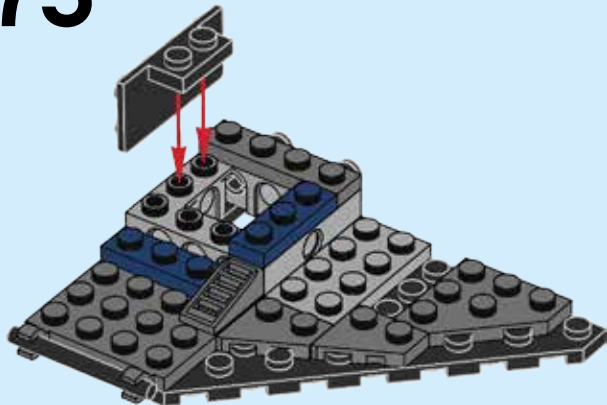

# 76

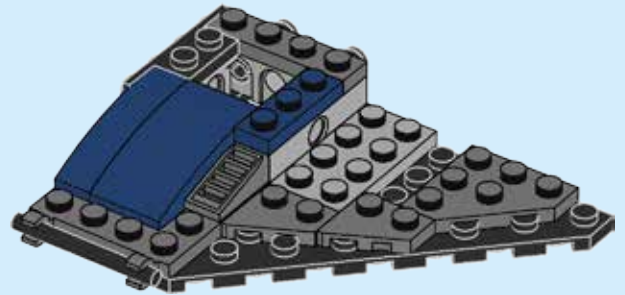

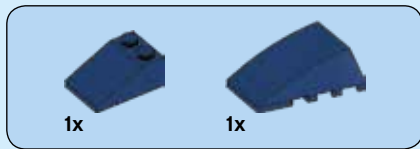

77

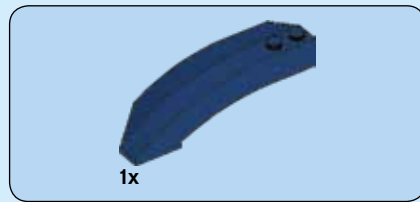
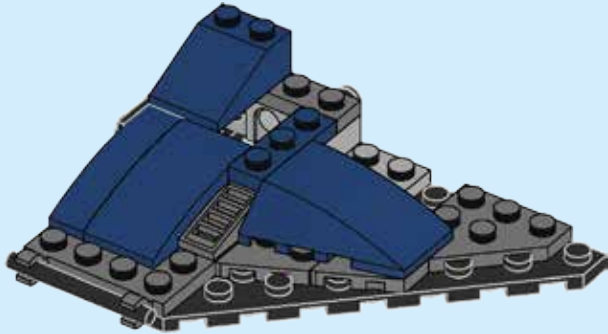

78

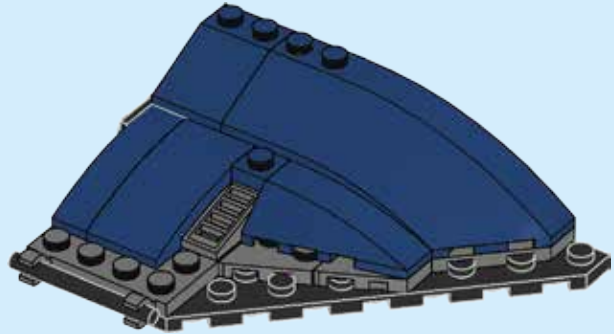

# 79

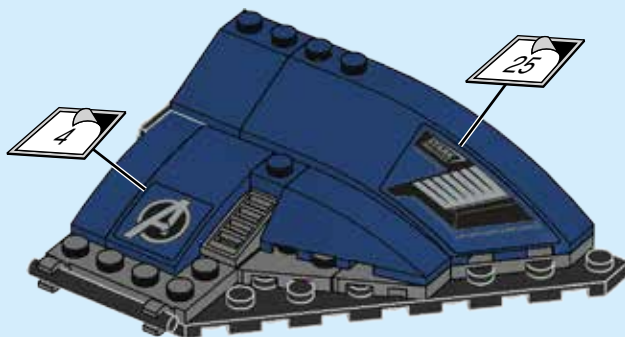

# 80

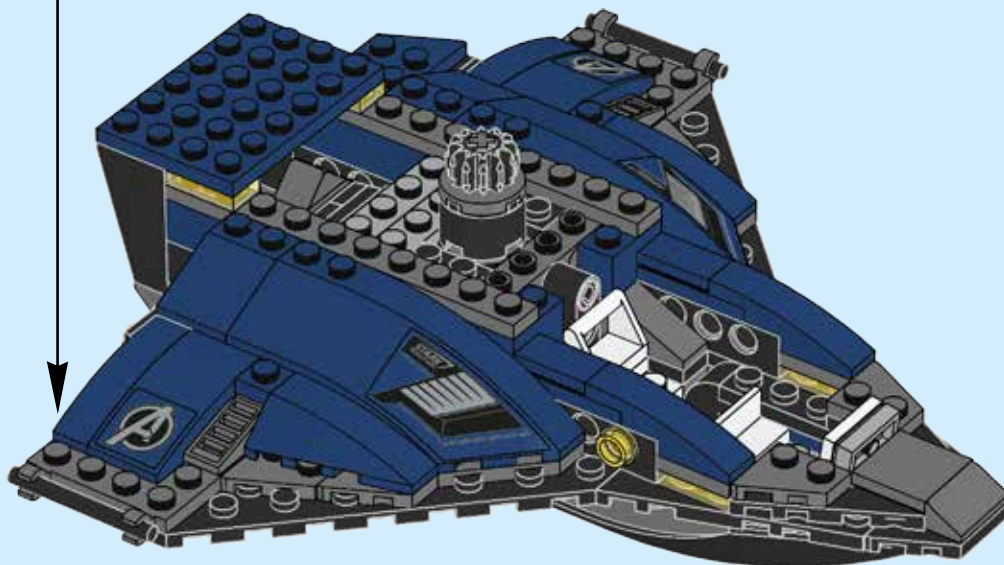
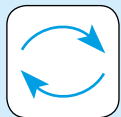



# 81

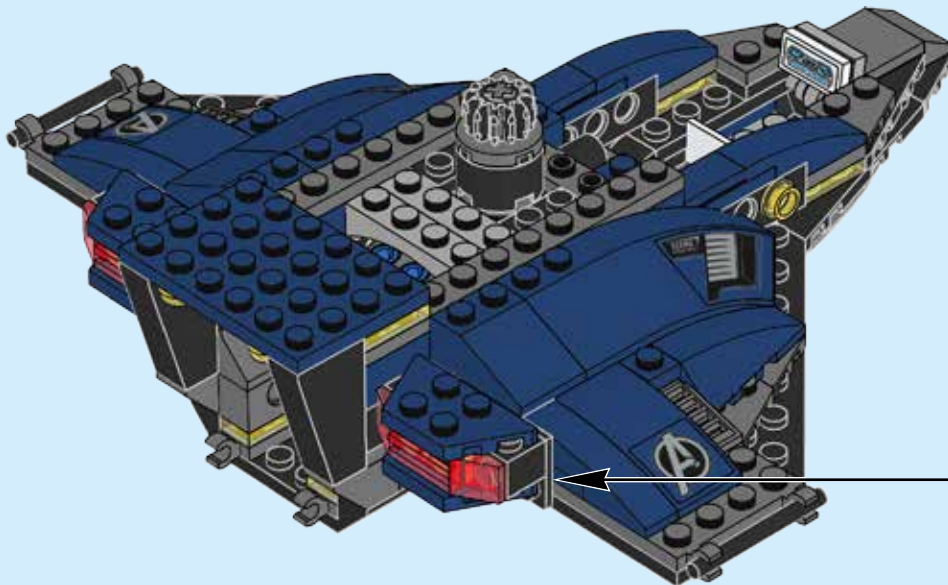
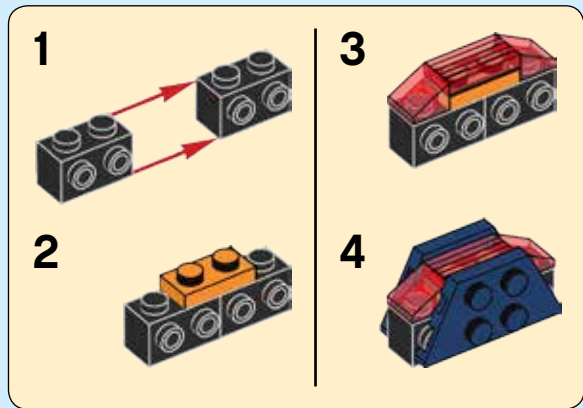

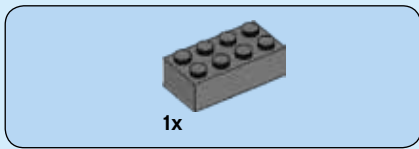

82

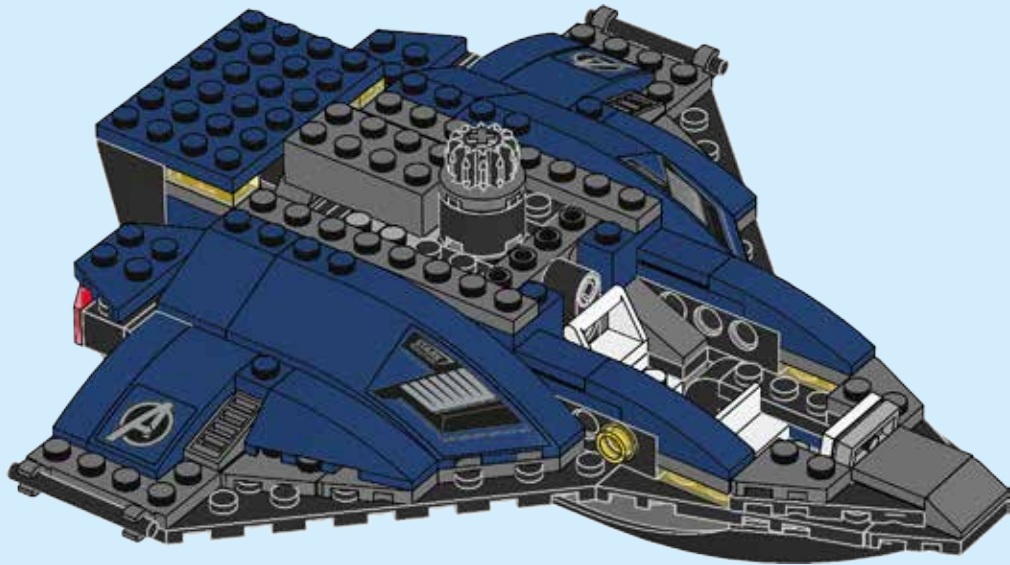



4x

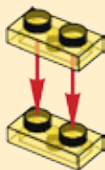

2x

# 83

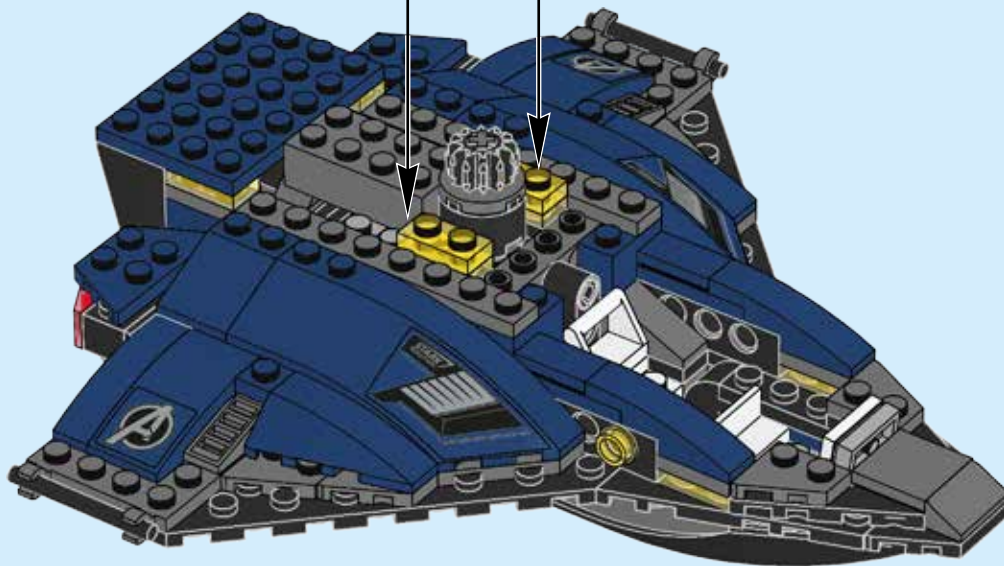





1x



2x

# 84

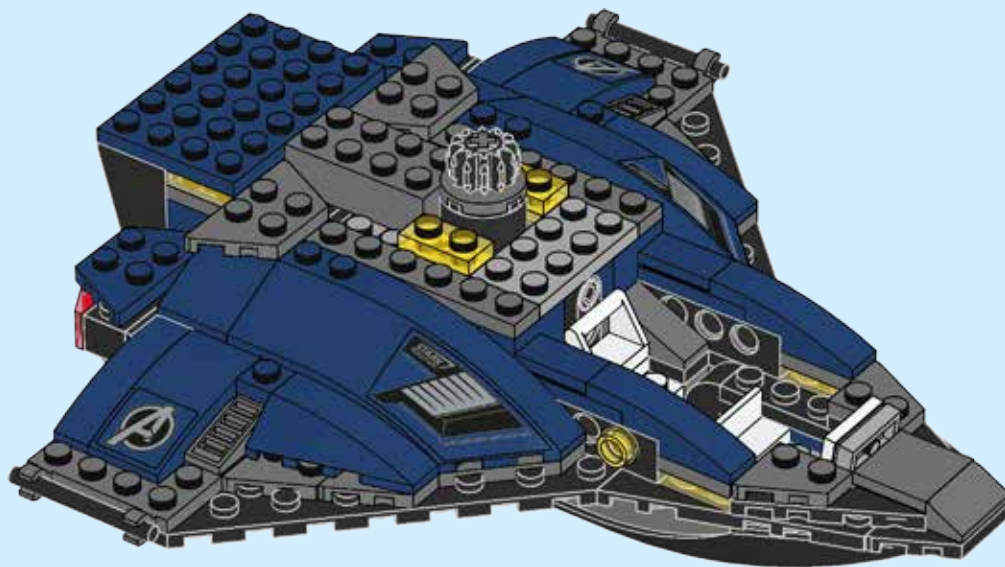

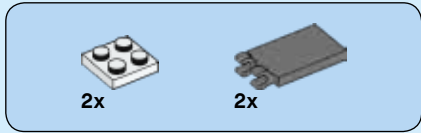

# 85

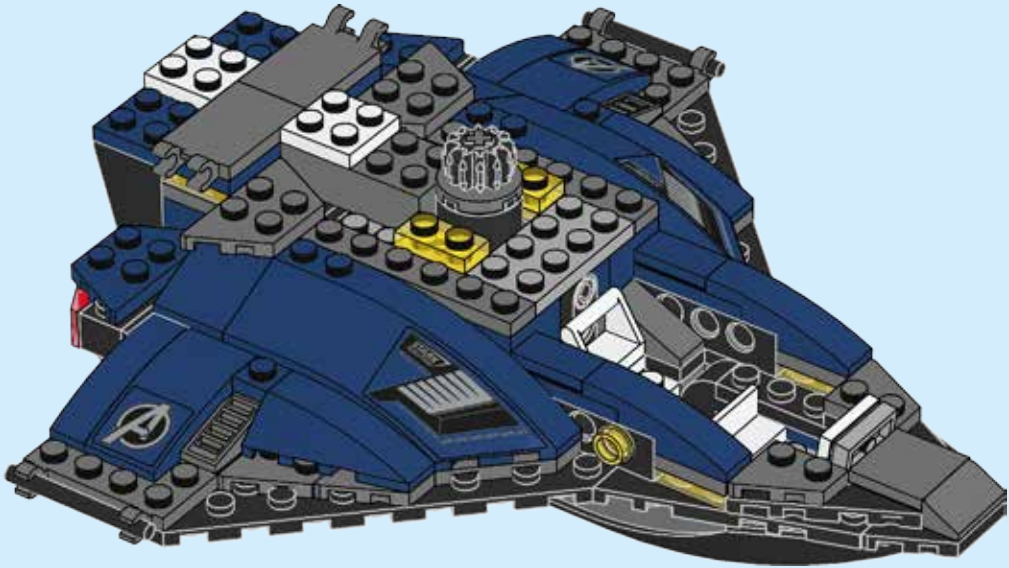



86

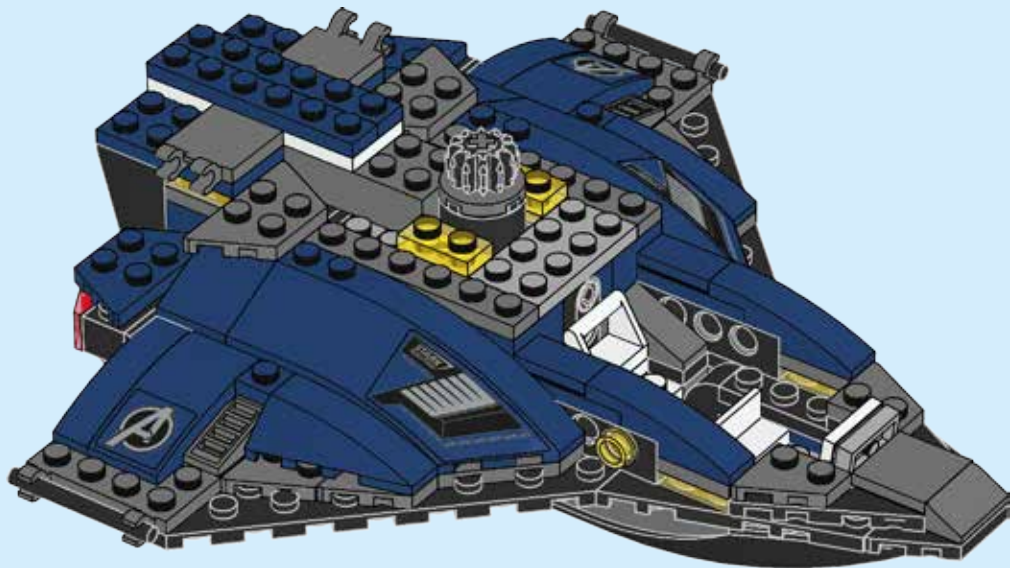



4x

# 87





2x

88

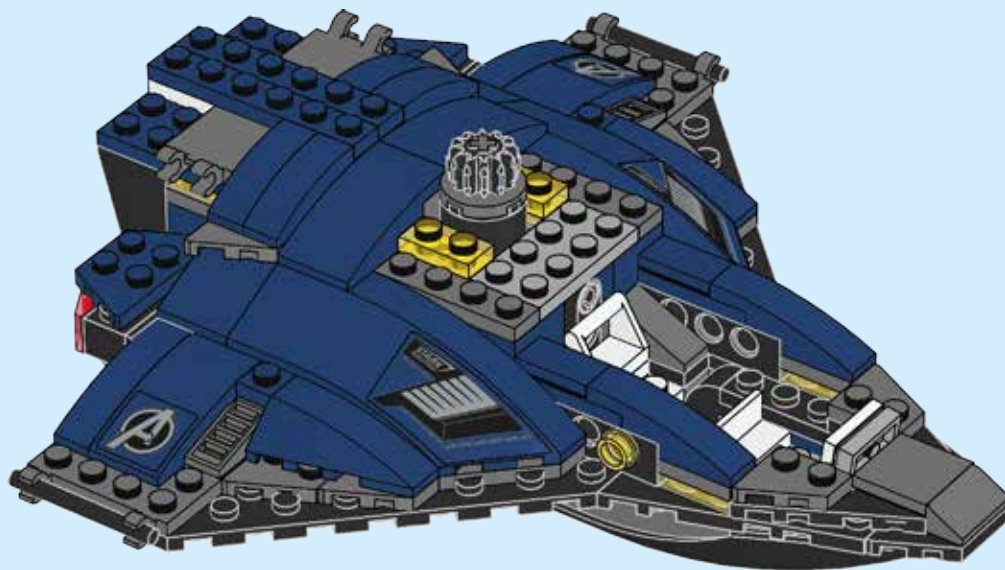



2x



2x

# 89

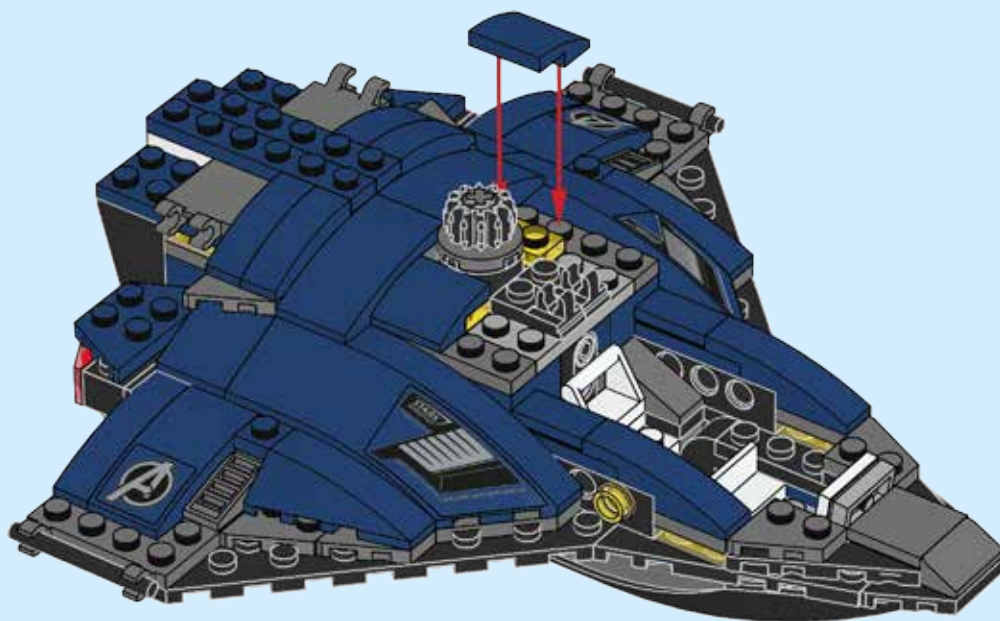



2x



2x

# 90

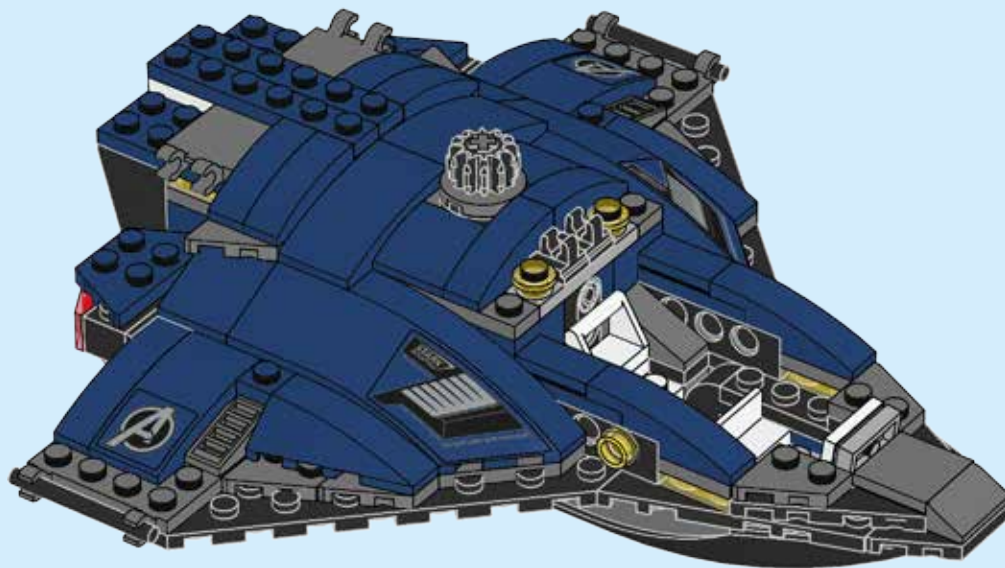



2x

# 91

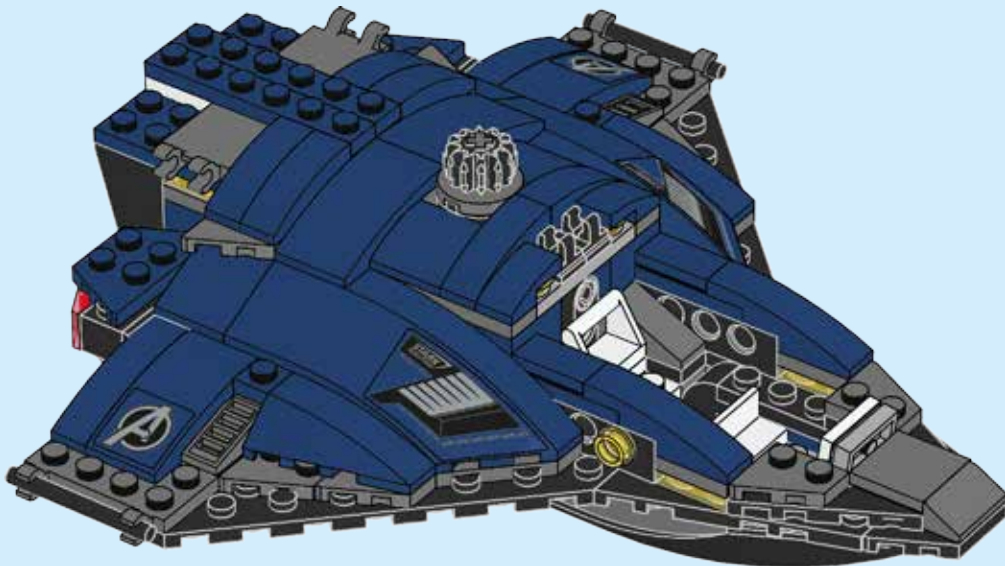



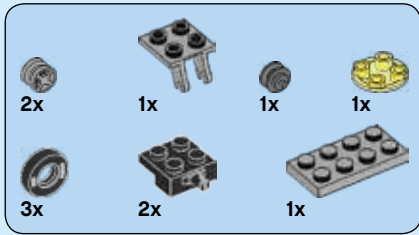

92

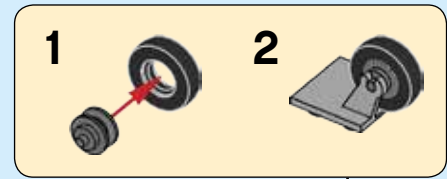
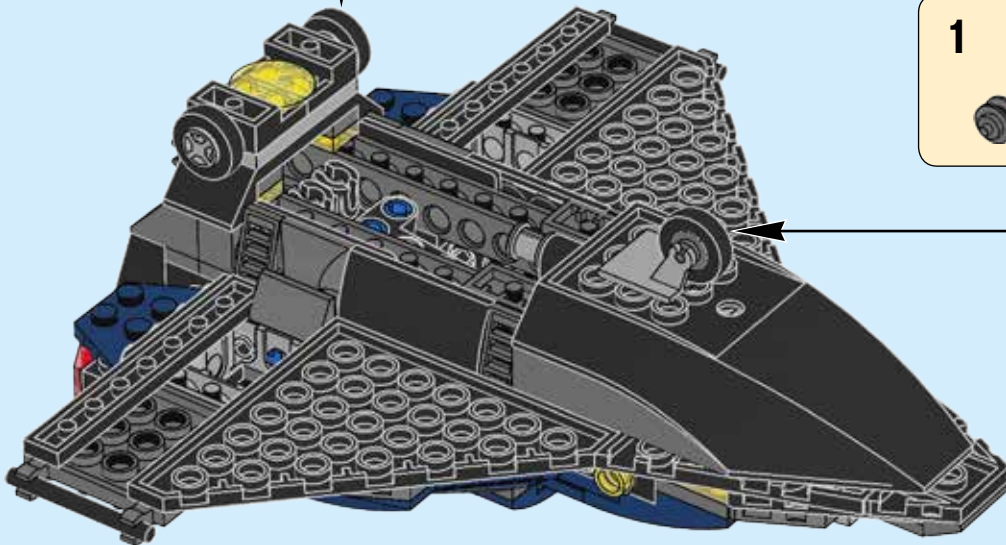
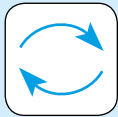
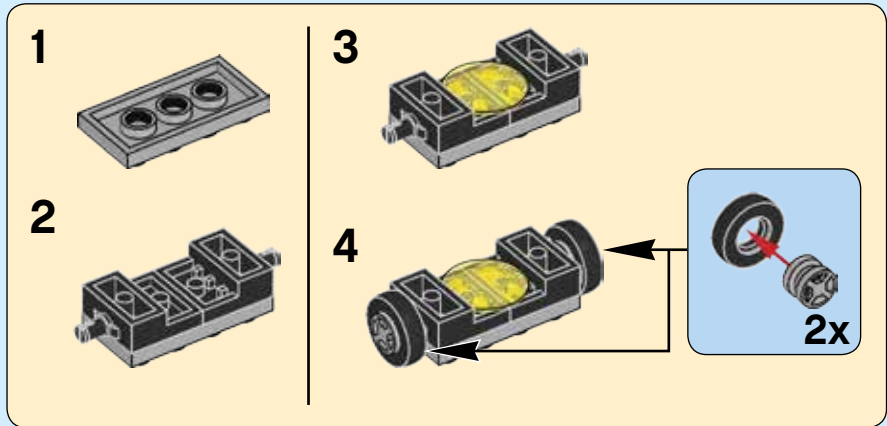



2x



2x

# 93

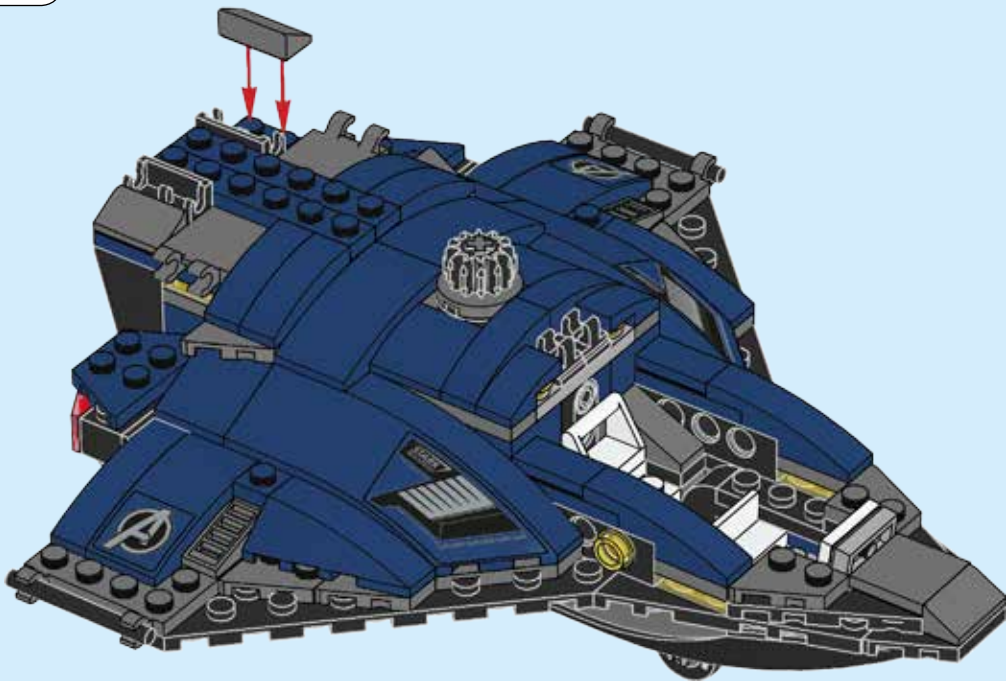
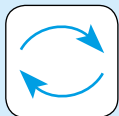

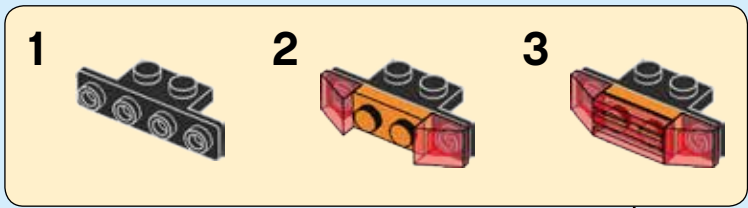
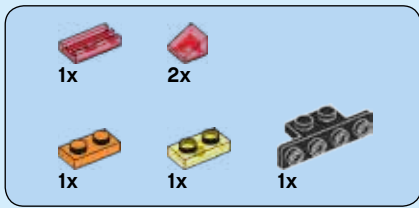

94

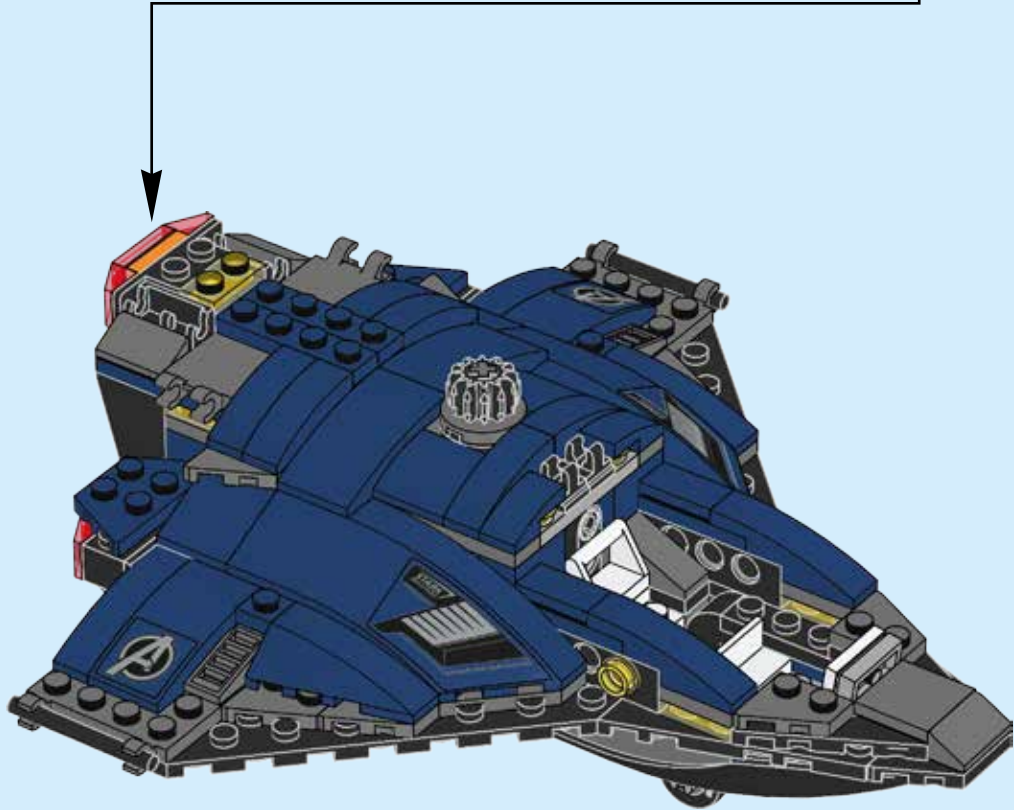

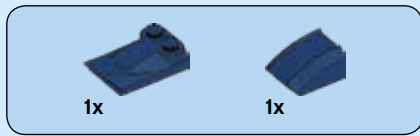

95

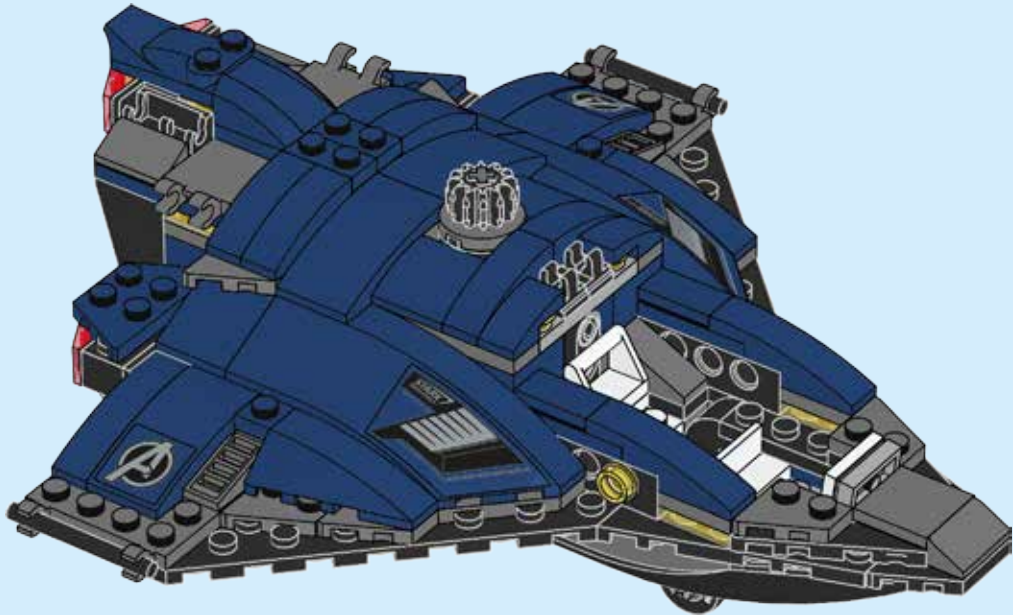



2x

# 96

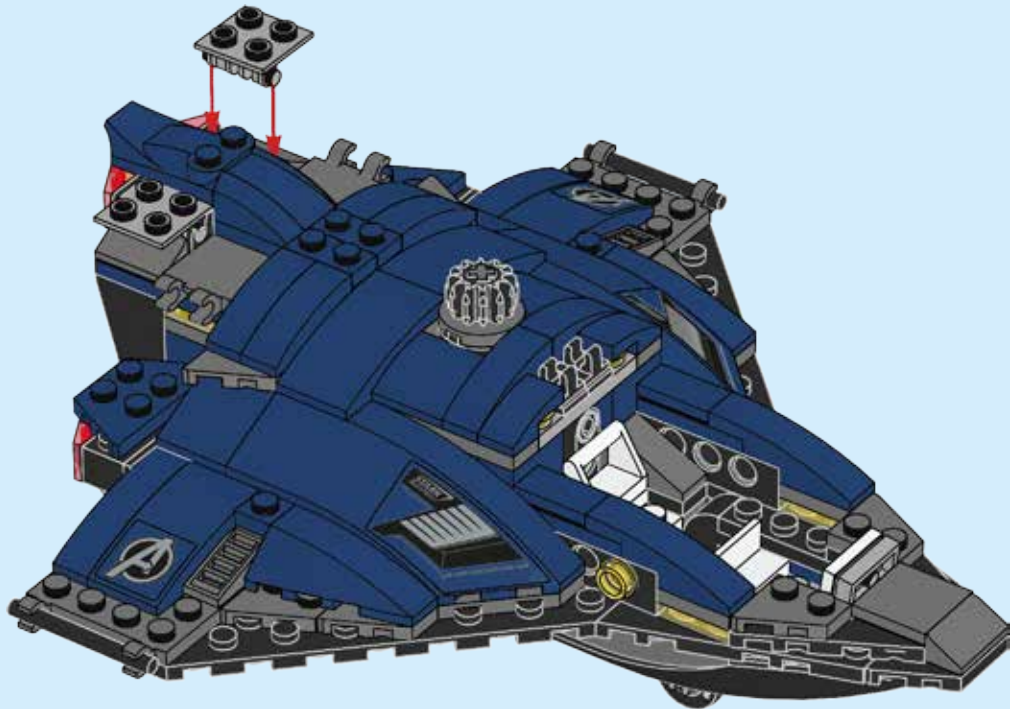



2x

# 97

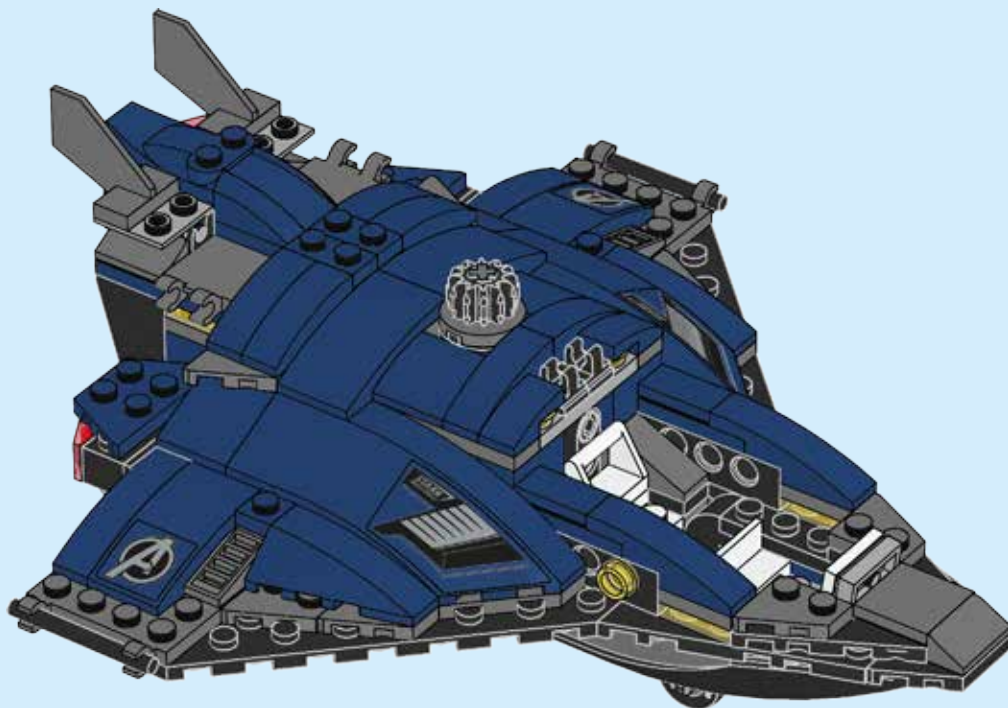



1x



1x

# 98

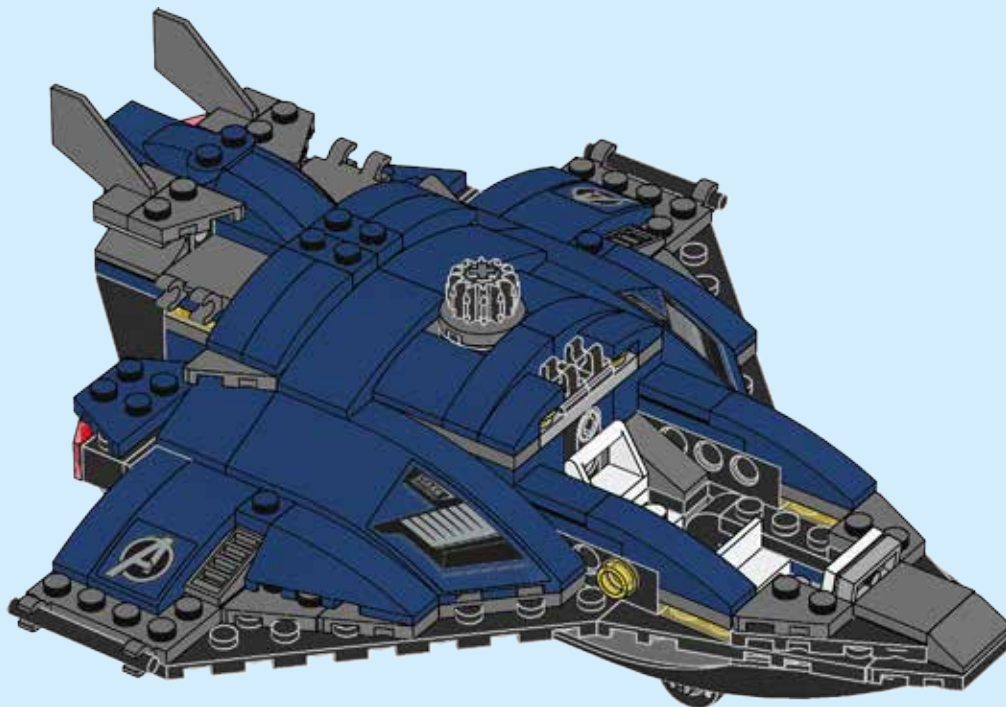

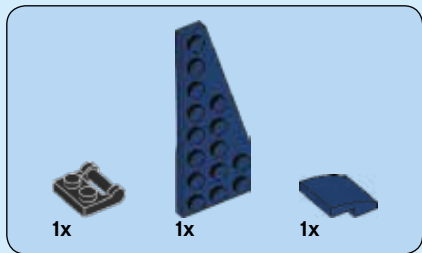

99

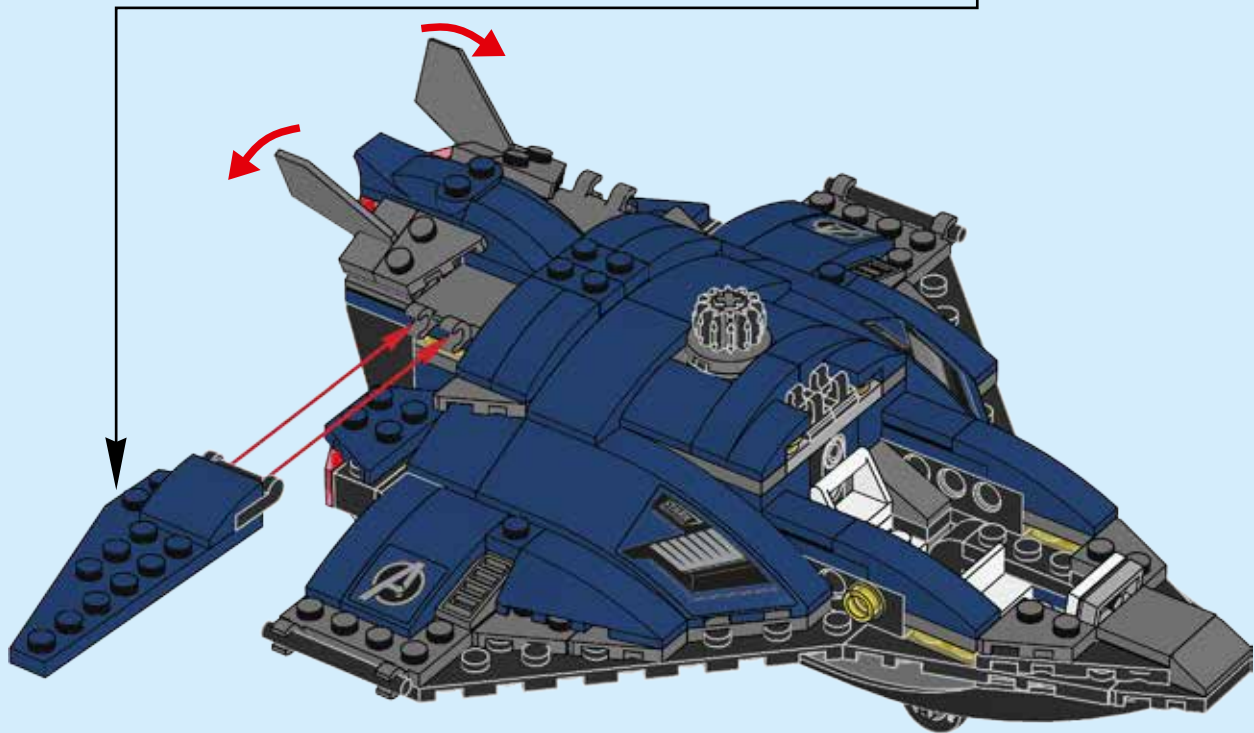
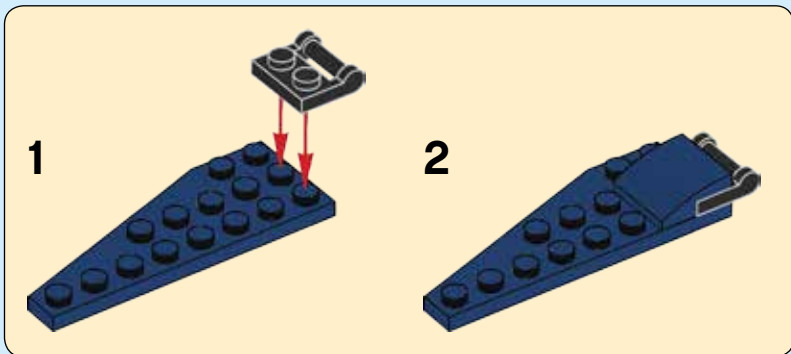



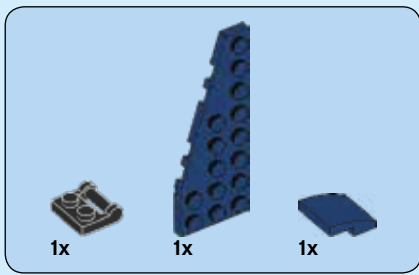

# 100

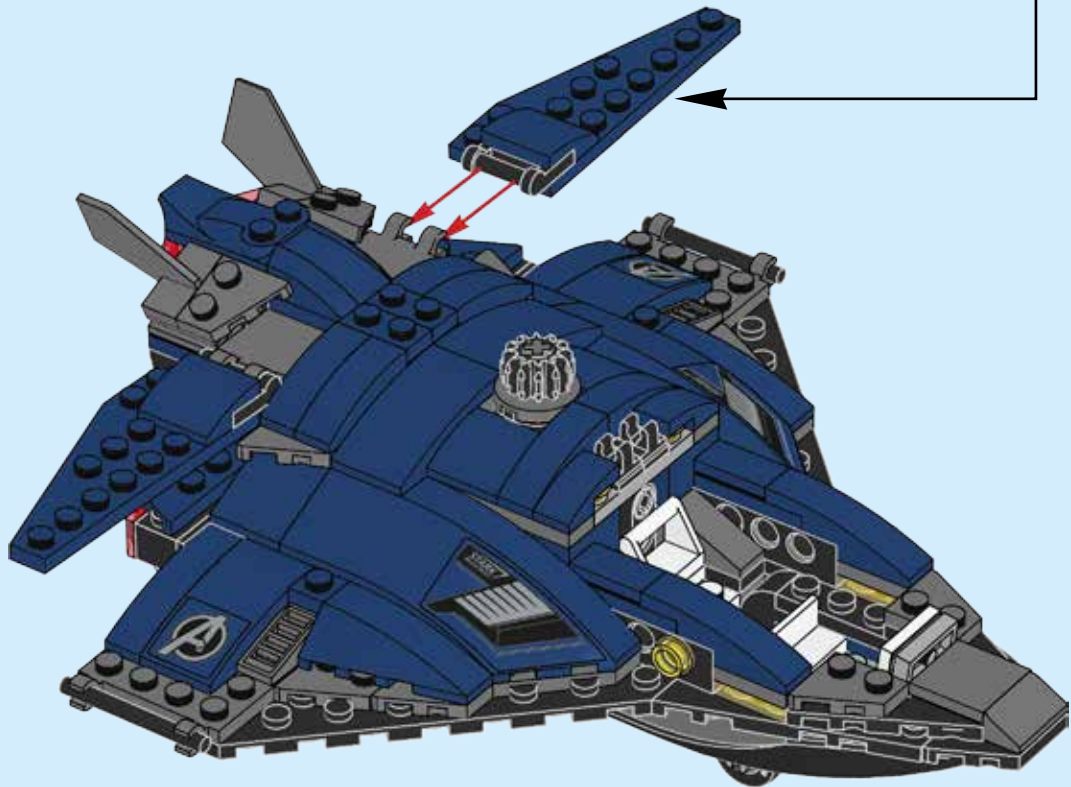
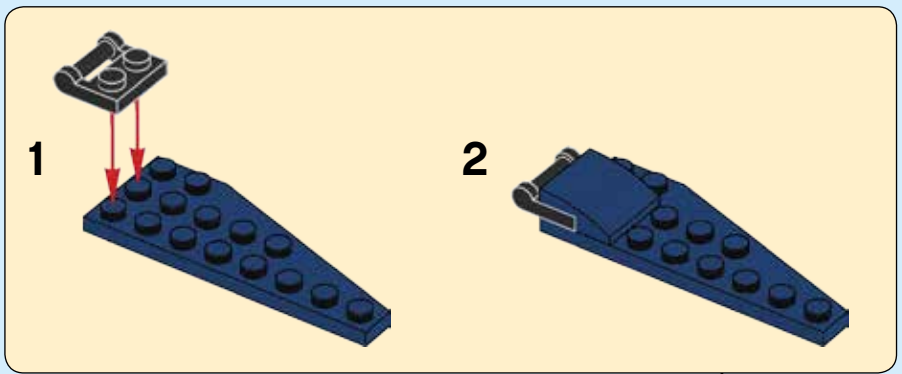



# 101

1

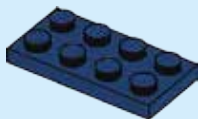

2

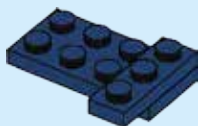

3

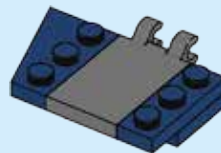

4

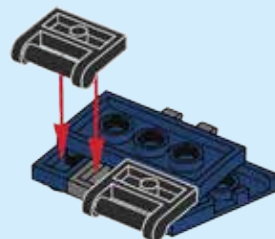
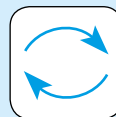

5

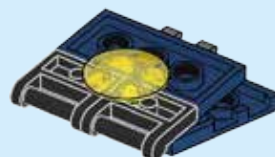





# 102

1



2



3

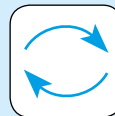
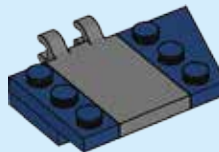

4

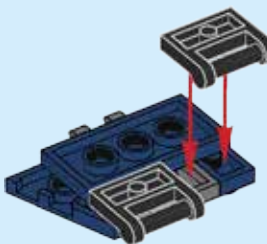

5

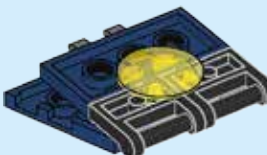

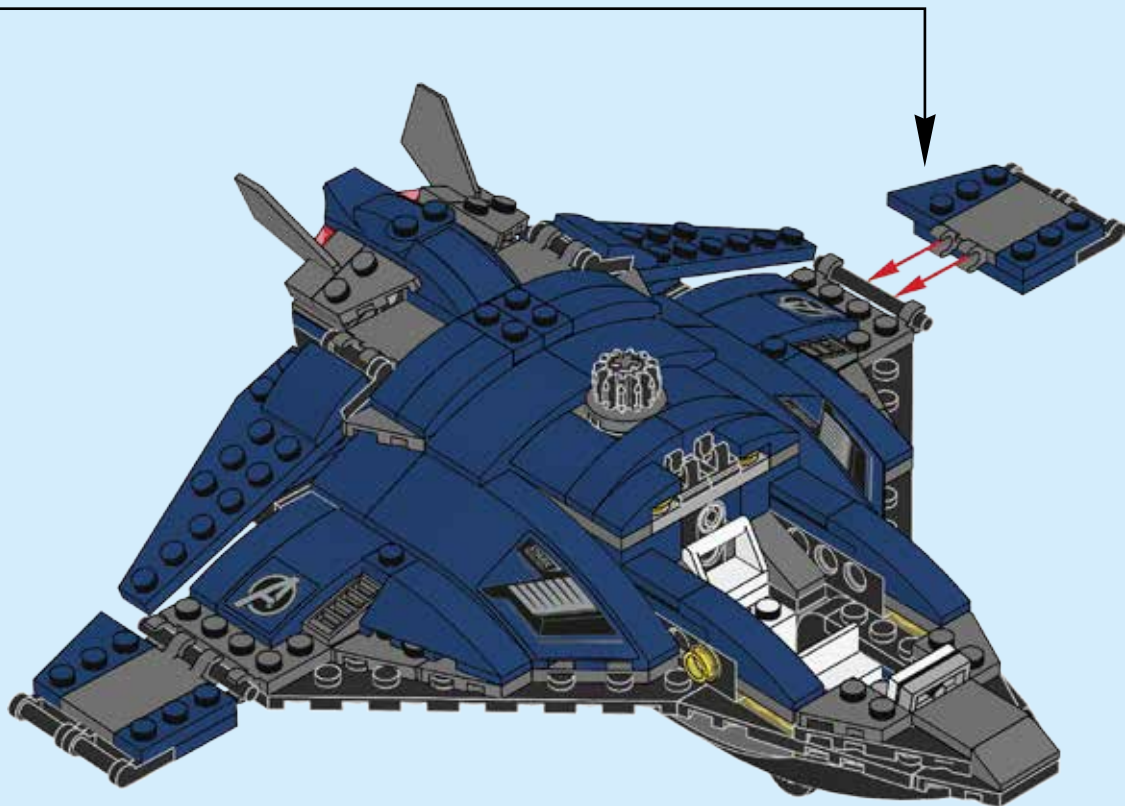

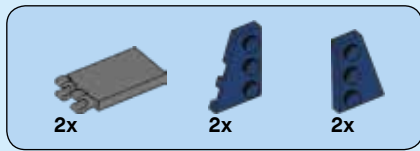

# 103

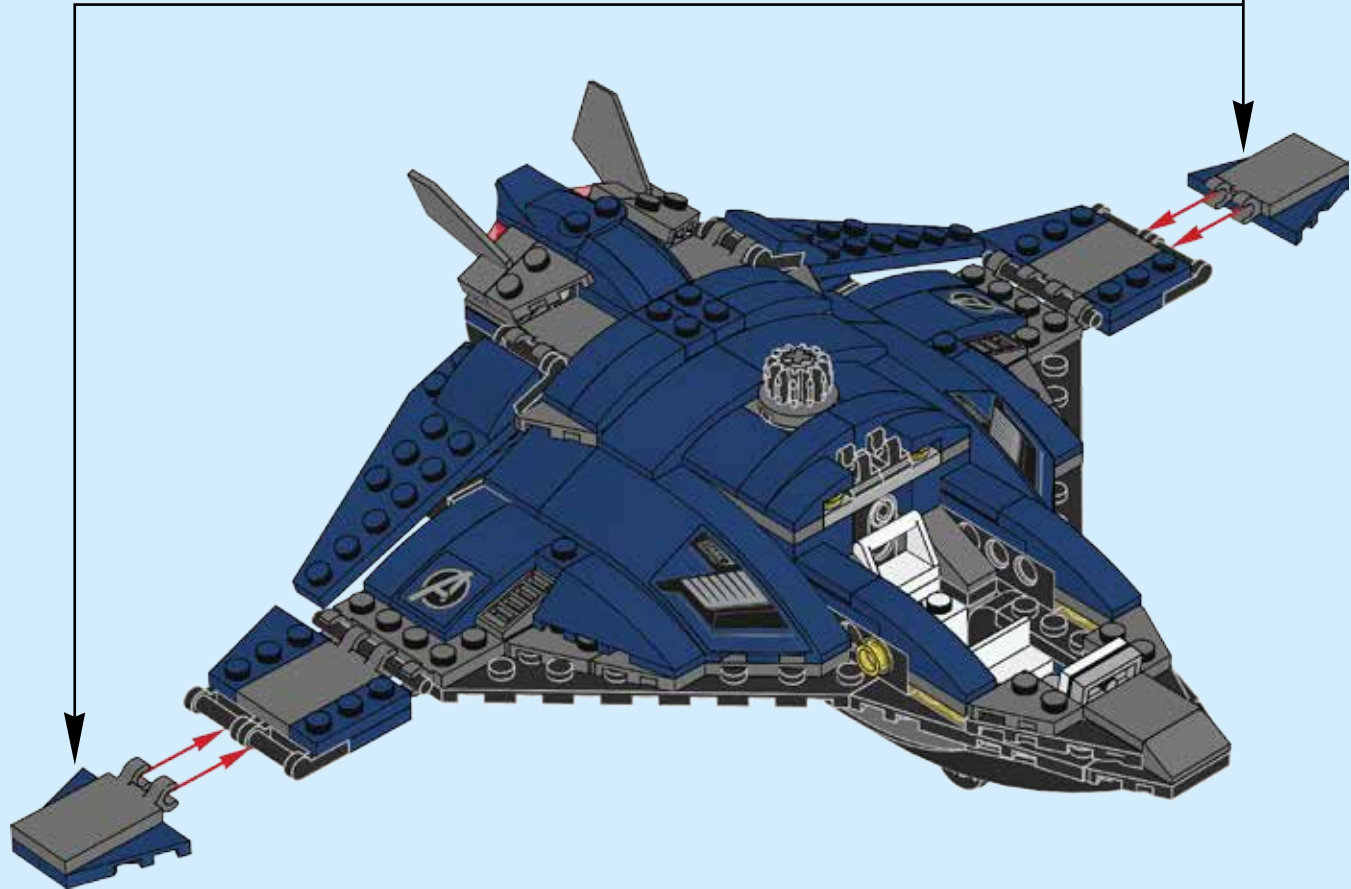
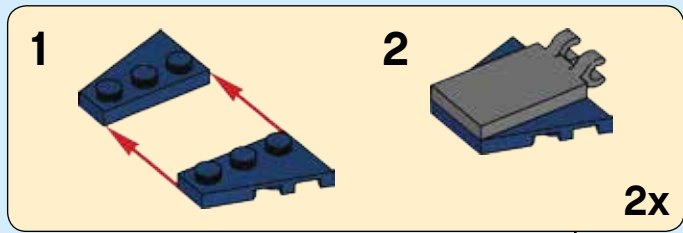

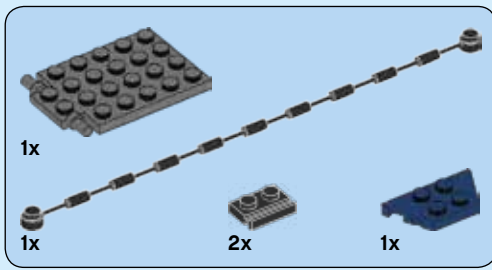

# 104

1



2

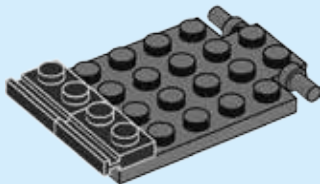

3

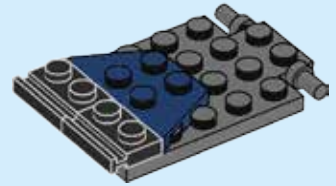

4

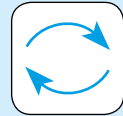

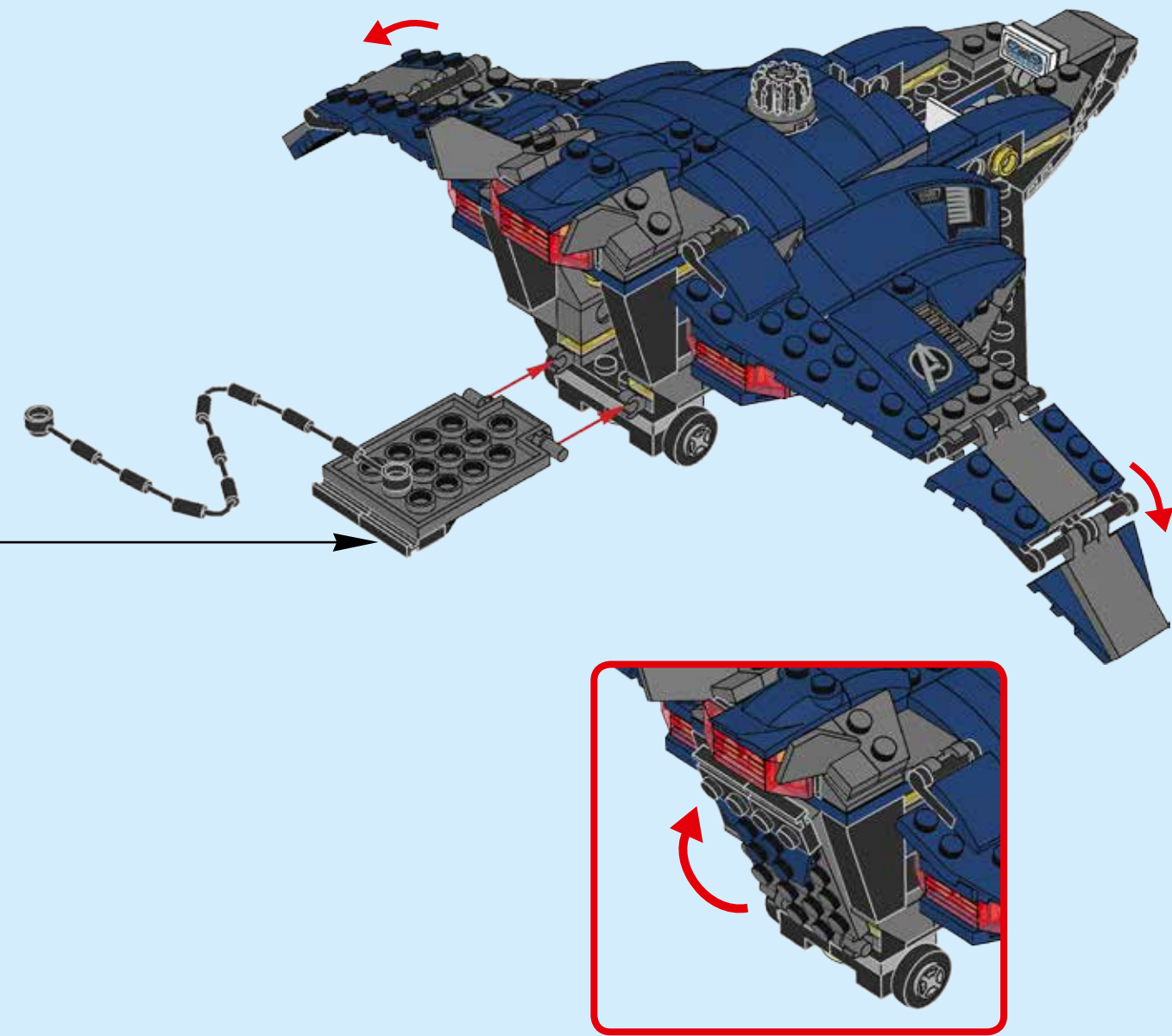



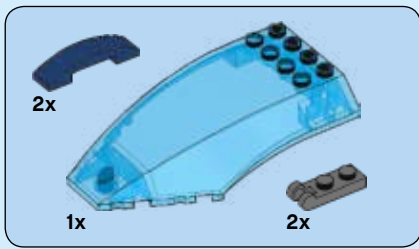

# 105

## 1

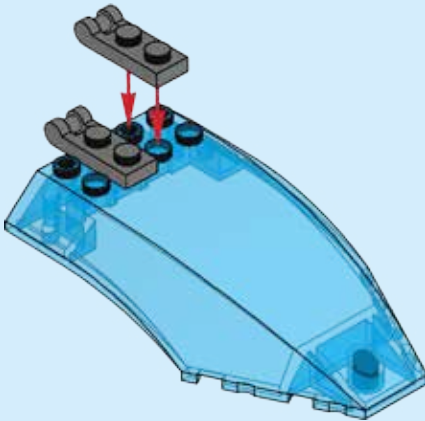

## 2

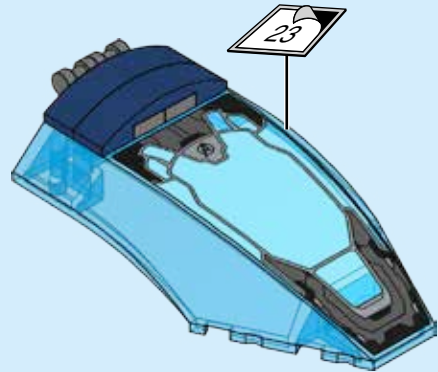

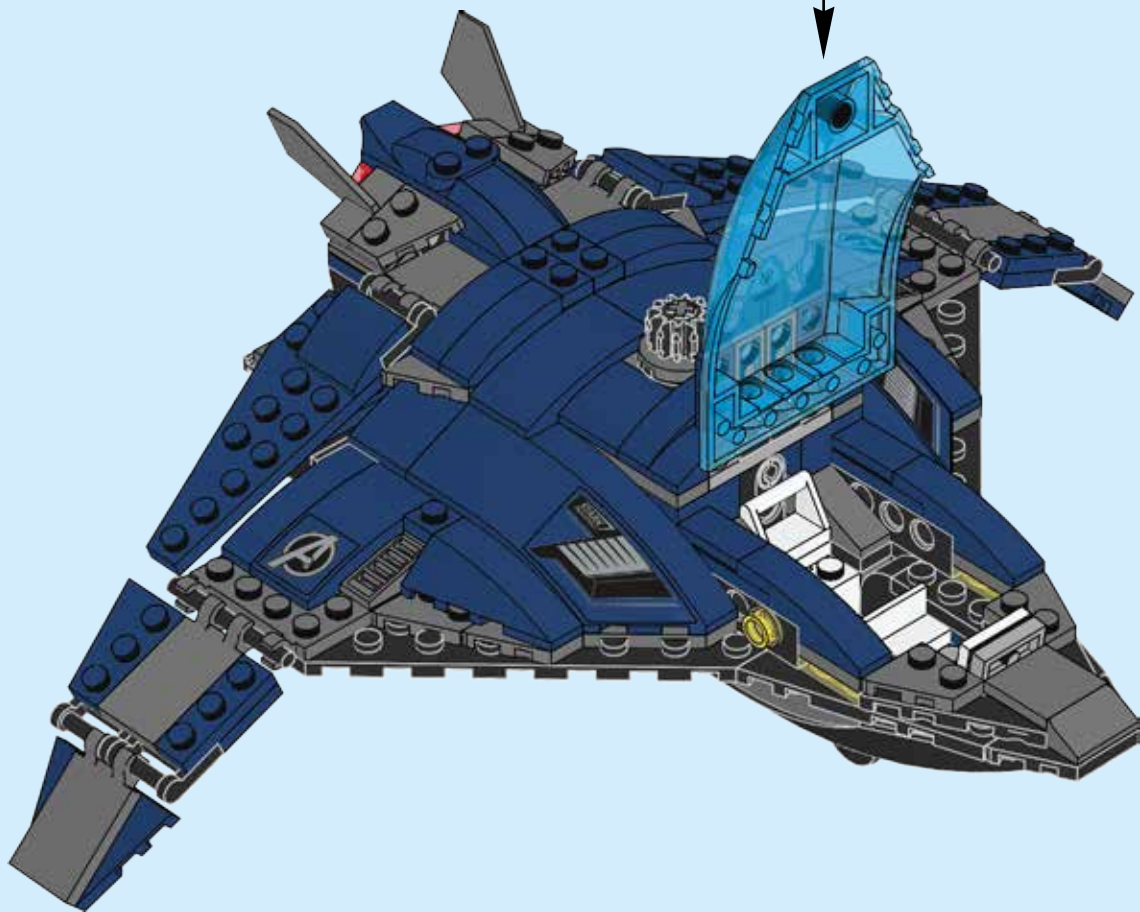

4x



# 106

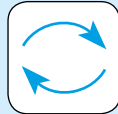

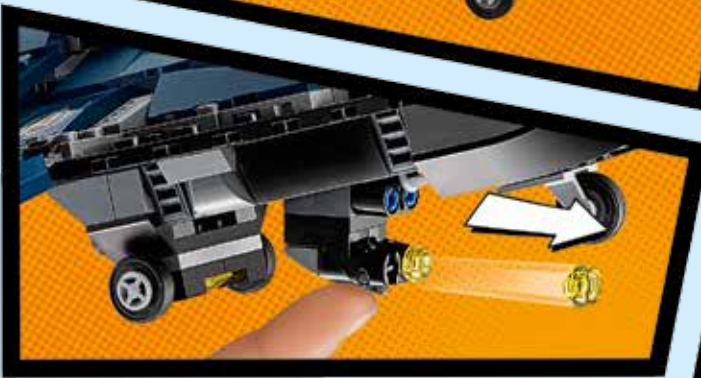

1x 4504369  
2x 300501  
1x 4116816  
4x 4547489  
3x 6092873  
1x 3200001  
1x 243201  
5x 306901  
3x 302301  
1x 486501  
1x 4113261  
5x 300401  
2x 4261470  
1x 368001

3x 302201  
1x 407901  
1x 4520970  
3x 362301  
1x 362201  
2x 4258358  
1x 6089574  
2x 4500469  
1x 6035762  
6x 301001  
1x 4541956  
1x 366601

4x 4504228  
1x 4565452  
1x 4278422  
3x 4205107  
3x 4109995  
3x 4185177  
1x 306221  
1x 459921  
1x 4227155  
1x 307021  
1x 4142865  
1x 403221  
2x 4632572  
1x 6071464  
1x 302321

2x 6092565  
1x 393721  
1x 368021  
1x 4175442  
1x 243121  
9x 4143005  
3x 4206482  
2x 4514553  
6x 4244363  
3x 4190187  
3x 3006841  
4x 4646864  
5x 3005741  
2x 4239601  
4x 300524  
2x 4550348

4x 302324  
3x 241224  
1x 4537985  
4x 242024  
1x 4190511  
2x 362224  
2x 6092648  
1x 371024  
1x 243124  
3x 4600177  
1x 6146518  
2x 6073231  
1x 6066102  
4x 300526  
1x 6146705

7x 4516843  
2x 4177431  
2x 4161332  
2x 4160869  
1x 6103643  
6x 4548180  
4x 4253815  
12x 4121715  
1x 614326  
4x 4508215  
1x 6146579  
2x 9339  
2x 4598528

1x 6051331  
4x 4541191  
2x 4121966  
2x 4636202  
2x 300426  
2x 609126  
4x 370026  
2x 306926  
4x 302326  
2x 393726  
2x 6020193  
2x 4107761  
6x 4225201  
1x 6093525  
6x 4558170

1x 4283047  
1x 4283046  
3x 306826  
2x 242026  
2x 6061032  
5x 302226  
3x 6053077  
2x 303926  
2x 6092658  
2x 6052126  
2x 6102734  
4x 362326



2x  
362226



1x  
6146542



1x  
400626



1x  
4154853



4x  
6118829



1x  
6089577



1x  
6145439



1x  
6146594



1x  
6145661



2x  
6116604



1x  
4531412



2x  
302126



1x  
370526



1x  
4120017



2x  
4285883



2x  
6039869



5x  
4599499



2x  
615726



2x  
4587844



1x  
4560182



6x  
302026



1x  
300126



1x  
4142135



2x  
6075062



2x  
6054852



1x  
6096958



1x  
4274405



2x  
389426



1x  
366626



1x  
617926



2x  
4160025

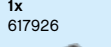

1x  
379526

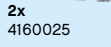

1x  
6131571



1x  
244126



2x  
346026

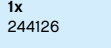

1x  
4209683

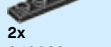

1x  
6096958



1x  
6060854



6x  
4650498



2x  
6047501



1x  
626440



1x  
6100958



1x  
382340



3x  
4183544



3x  
4163917



1x  
4581214



1x  
4124073



1x  
6089633



2x  
4205347



2x  
4107558



1x  
6039881



3x  
6012730



12x  
3005744



3x  
4278415



13x  
4194746



2x  
4599535



2x  
4129859



4x  
4183133



1x  
4267425



2x  
6031821



2x  
4173805



3x  
4177932



1x  
4654448



1x  
6109387



3x  
6143413



3x  
6143414



1x  
4162916



2x  
4249891



2x  
6094143



2x  
4528488



1x  
4651373



1x  
4651377



4x  
6061569



1x  
6110004

10x  
4177735

6x  
4540280

5x  
4613335

2x  
6025376

1x  
6062104

4x  
6042956

2x  
4264569

2x  
6037886

2x  
4667595

4x  
6056662

2x  
6115178

2x  
4508313

1x  
6074665

1x  
6037887

1x  
6074660

1x  
6107539

1x  
6008350

1x  
6111232

2x  
4585479

1x  
6146514

3x  
4542673

1x  
6105910

2x  
4211257

1x  
6109389

1x  
4211235

1x  
6146897

3x  
4211194

2x  
4579690

2x  
4539481

4x  
4650260

2x  
4211525

6x  
4211506

2x  
4558953

2x  
4211389

5x  
4211399

4x  
6011375

2x  
4594238

1x  
4211791

1x  
4211794

2x  
4568637

1x  
4211512

2x  
4540203

1x  
4211807

2x  
4512360

1x  
4227776

2x  
4211414

1x  
6028812

1x  
4211470

4x  
4211350

6x  
4211357

1x  
4226995

2x  
6089147

2x  
4211519

4x  
4211398

1x  
4211564

2x  
6015344

2x  
4654582

1x  
4211632

2x  
4630114

2x  
4211353

1x  
4530469

1x  
4211351

1x  
4494475

1x  
4211387

2x  
4211881

1x  
4211815

1x  
4211865

2x  
4558169

1x  
4211419

1x  
6118827

3x  
4211396

2x  
4610112

1x  
6146517

3x  
4211561

2x  
4211441

4x  
4211445

1x  
4211473

2x  
6102769

7x  
4211395

1x  
4211444

1x  
4646513

1x  
6028811

4x  
4211549

2x  
4618874

2x  
4211640

1x  
4211542

2x  
4211452

1x  
4211442

1x  
4211716

1x  
4211716

1x  
4251564

1x  
4211408

1x  
4289542

- |               |                |               |               |               |               |               |
|---------------|----------------|---------------|---------------|---------------|---------------|---------------|
| 1x<br>6005463 | 2x<br>6055313  | 2x<br>4210935 |               | 3x<br>4598769 |               | 1x<br>6112518 |
| 1x<br>6100030 | 1x<br>4211042  | 1x<br>4493478 | 2x<br>4582820 | 6x<br>4227517 | 6x<br>6062482 | 1x<br>6104166 |
| 2x<br>6012451 | 6x<br>4567887  | 2x<br>6000606 | 2x<br>4211045 | 2x<br>4210897 | 1x<br>4595710 | 1x<br>6003610 |
| 3x<br>6051334 | 1x<br>6019987  | 2x<br>6117972 | 1x<br>6086709 | 2x<br>4560184 | 1x<br>4211115 | 1x<br>6079034 |
| 4x<br>4211098 | 2x<br>4211096  | 2x<br>6117972 | 1x<br>6027686 | 3x<br>4211065 | 2x<br>4257526 | 1x<br>6146510 |
| 2x<br>6071226 | 8x<br>4211063  | 2x<br>4581225 | 1x<br>6118832 | 2x<br>4211085 | 1x<br>6133611 | 1x<br>6146516 |
| 3x<br>4210639 | 6x<br>6069164  | 1x<br>4583879 | 2x<br>6146792 | 1x<br>4508553 | 1x<br>6133611 | 1x<br>6146516 |
| 3x<br>6063616 | 11x<br>6000311 | 1x<br>6071261 | 2x<br>6146792 | 2x<br>4210779 | 2x<br>4210963 | 1x<br>4568934 |
| 4x<br>6143417 | 1x<br>4210762  | 1x<br>4211055 | 2x<br>4582257 | 4x<br>4211043 | 2x<br>4210963 | 1x<br>6107631 |
| 4x<br>6143423 | 2x<br>6039479  | 2x<br>4218696 | 2x<br>4527082 | 1x<br>4210917 | 1x<br>4210802 | 1x<br>4632571 |
| 1x<br>4623236 | 3x<br>4210900  | 2x<br>6015356 | 4x<br>4211043 | 2x<br>4211056 | 1x<br>4210802 | 1x<br>4632571 |
|               | 6x<br>4540386  | 2x<br>4521187 | 1x<br>6083620 | 1x<br>4243831 | 1x<br>4256149 | 1x<br>6142578 |
|               |                |               | 3x<br>4648256 | 2x<br>6039699 |               |               |
|               |                |               | 5x<br>4211001 |               |               |               |
|               |                |               | 4x<br>4211053 |               |               |               |



**Customer Service**

Kundenservice

Service Consommateurs

Servicio Al Consumidor

[LEGO.com/service](http://LEGO.com/service) or dial



00800 5346 5555 :



1-800-422-5346 :







**MARVEL**  
**SUPER**  
**HEROES**



76051



76047



76050



76051

76047

76050



marvelkids.com

© MARVEL

**MARVEL**  
**CAPTAIN AMERICA**



# MARVEL SUPER HEROES



**LEGO.COM/MARVELSUPERHEROES**



# MARVEL AVENGERS



video games

LEGO.com/videogames



RATING PENDING  
COTE EN ATTENTE

**RP**  
ESRB

Visit [esrb.org](http://esrb.org) for rating information  
Visiter [esrb.org](http://esrb.org) pour les classifications

PS3 PS4 PSVITA XBOX ONE XBOX 360

PC Wii U NINTENDO 3DS Nintendo eShop

©2016 The LEGO Group. © MARVEL.™ & © WBEI. (s16)

**MARVEL**  
marvelkids.com  
© MARVEL

TELEVISION GAMES WB GAMES

# WIN

GO TO [WWW.LEGO.COM/PRODUCTFEEDBACK](http://WWW.LEGO.COM/PRODUCTFEEDBACK) AND  
GIVE US YOUR SHORT **FEEDBACK** ABOUT THIS  
LEGO® SET FOR A CHANCE TO WIN  
A COOL LEGO PRIZE.



## LEGO.com/productfeedback

### GEWINNE



Erzähle uns auf  
[www.LEGO.com/productfeedback](http://www.LEGO.com/productfeedback)

*etwas über die Erfahrungen, die du mit  
diesem LEGO® Set gemacht hast, und  
sichere dir die Chance auf einen coolen  
LEGO Preis!*

### GAGNE



Rends-toi sur  
[www.LEGO.com/productfeedback](http://www.LEGO.com/productfeedback)

*et donne-nous quelques commentaires  
sur ce produit LEGO® pour avoir une  
chance de gagner un prix LEGO !*

### GANAN



Visita  
[www.LEGO.com/productfeedback](http://www.LEGO.com/productfeedback)

*y envíanos tu opinión acerca de este set  
LEGO®. ¡Participarás en el sorteo de un  
premio LEGO!*

### 获取奖品



登录  
[www.LEGO.com/productfeedback](http://www.LEGO.com/productfeedback)

*给出关于此乐高®套装的简短反馈，  
就有机会获得炫酷乐高奖品*

LEGO and the LEGO logo are trademarks of the/son des marques de commerce du/son marcas registradas de LEGO Group.  
©2016 The LEGO Group.

**MARVEL**  
marvelkids.com

© MARVEL

6160350