



# CITY

60072



1



2



3



4



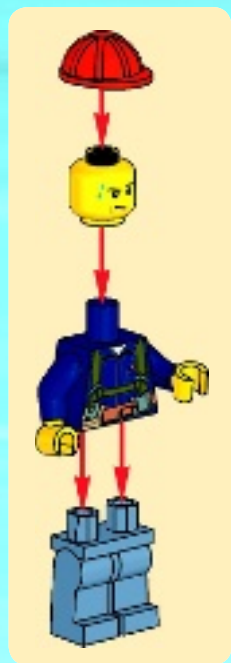

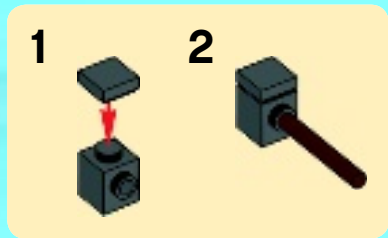

1



2



2x



1x

1



2x

2





1x

**3**





1x



1x

4



1x

5





1x

6







1x



2x

# 7

1



2

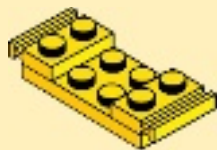



1x



2x

8





2x



2x

9



1x

10





2x

11





2x



1x

# 12

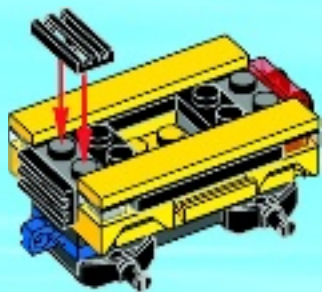

2x



2x

# 13

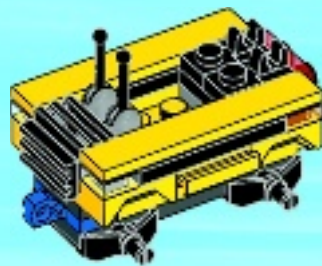



1x

14

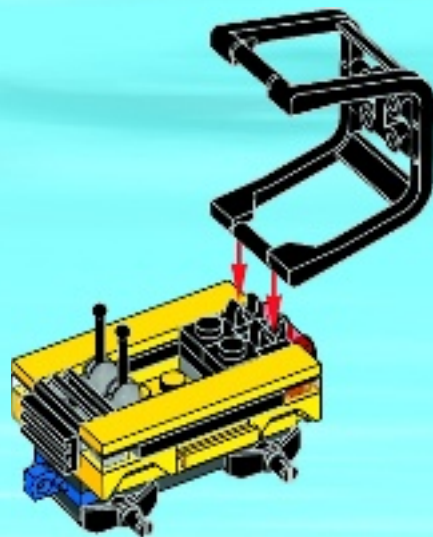



4x



4x

# 15

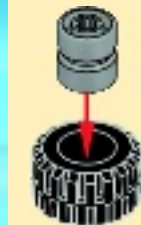

4x



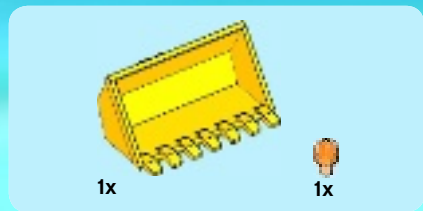

16





17

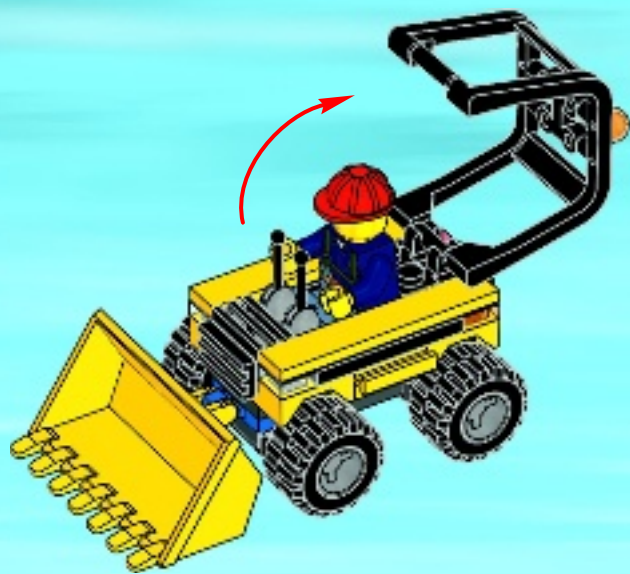



1x

1





3x

2



1x

3

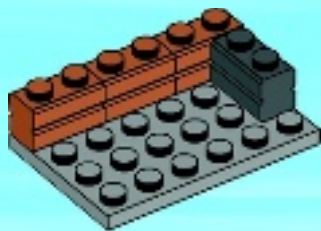



1x



1x

4





1x



2x

5



1x



1x

6





1x



1x

7





1x



2x

8



2x



2x

9



2x







# CITY



60076



60075



60074



60073



60072



# FREE ONLINE GAME & APP!

KOSTENLOSES ONLINE-SPIEL & APP! - JEU EN LIGNE ET APPLUS GRATUITES!  
¡JUEGO ONLINE Y APP GRATIS! - JOGO e APLICACAO ONLINE GRATIS!  
INGYENES ONLINE JÁTÉK ÉS APP! - BEJUTÓ-REGISZTERO APP KIFE!

WWW.LEGO.COM/CITY



LEGO.COM/CITY

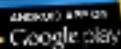

Apple, the Apple logo, iPad, iPhone and iPod touch are trademarks of Apple Inc., registered in the U.S. and other countries.  
App Store is a service mark of Apple Inc.  
Google Play is a trademark of Google Inc.



Customer Service

Kundenservice

Service Consommateurs

Servicio Al Consumidor

LEGO.com/service or dial



: 00800 5346 5555

: 1-800-422-5346

# WIN

GO TO [WWW.LEGO.COM/PRODUCTFEEDBACK](http://WWW.LEGO.COM/PRODUCTFEEDBACK) AND  
GIVE US YOUR SHORT **FEEDBACK** ABOUT THIS  
LEGO® SET FOR A CHANCE TO WIN  
A COOL LEGO PRIZE.



## LEGO.com/productfeedback

### GEWINNE



Erzähle uns auf  
[www.LEGO.com/productfeedback](http://www.LEGO.com/productfeedback)

etwas über die Erfahrungen, die du mit  
diesem LEGO® Set gemacht hast, und  
sichere dir die Chance auf einen coolen  
LEGO Preis!

### GAGNE



Rends-toi sur  
[www.LEGO.com/productfeedback](http://www.LEGO.com/productfeedback)

et donne-nous quelques commentaires  
sur ce produit LEGO® pour avoir une  
chance de gagner un prix LEGO !

### GANAN



Visita  
[www.LEGO.com/productfeedback](http://www.LEGO.com/productfeedback)

y envíanos tu opinión acerca de este set  
LEGO®. ¡Participarás en el sorteo de un  
premio LEGO!

### 获取奖品



登录  
[www.LEGO.com/productfeedback](http://www.LEGO.com/productfeedback)

给出关于此乐高®套装的简短反馈，  
就有机会获得炫酷乐高高奖品