



CITY

60050



1



2



3



4



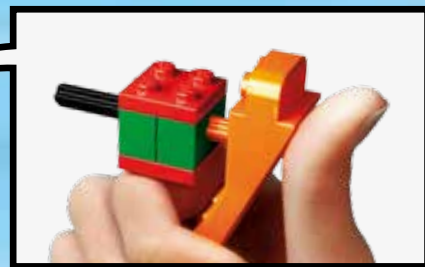
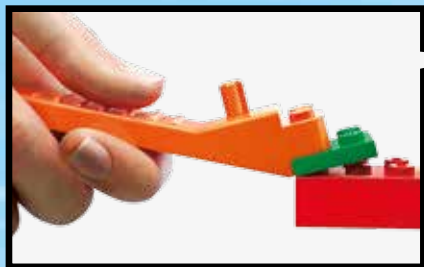

LEGO.com/brickseparator

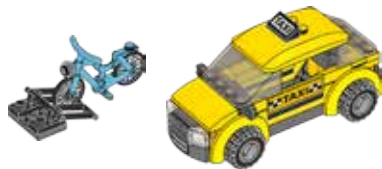





2x



1x

1

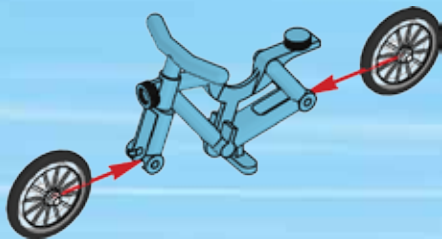

1x

2

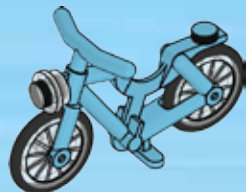

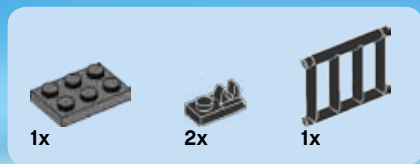

3

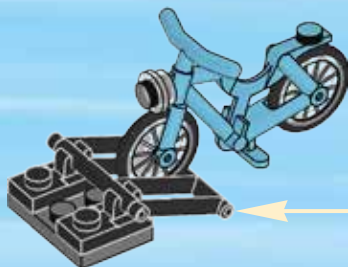
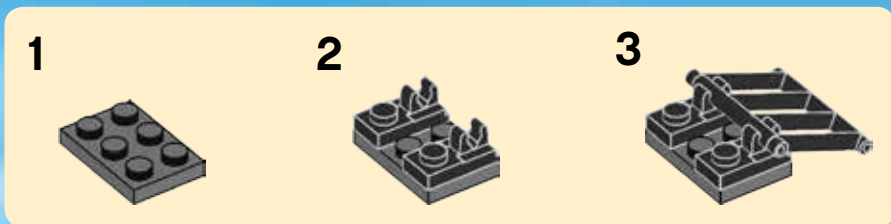



1x

1

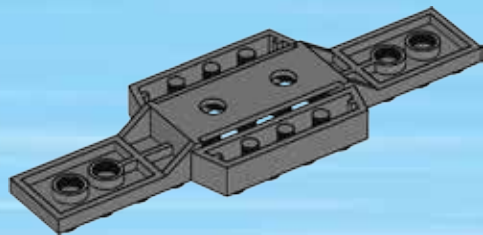



2x

2

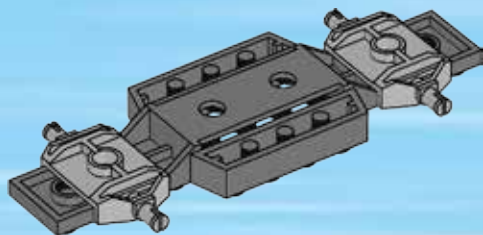

1x

3

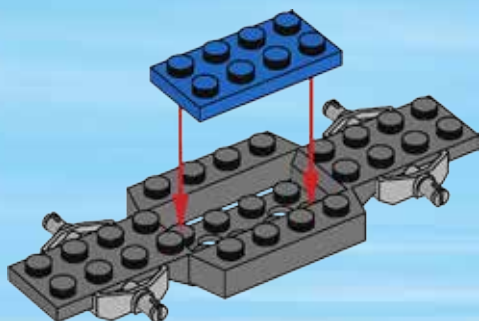

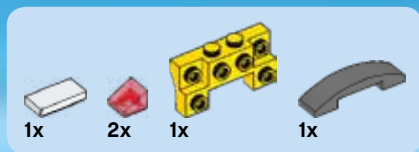

4

1



2



3



4

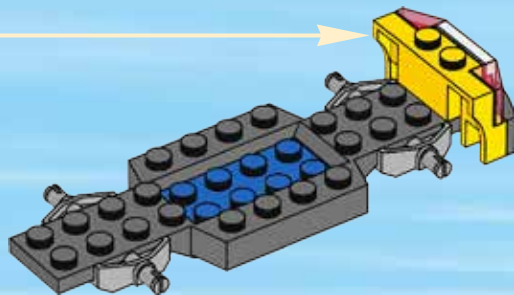



2x

5

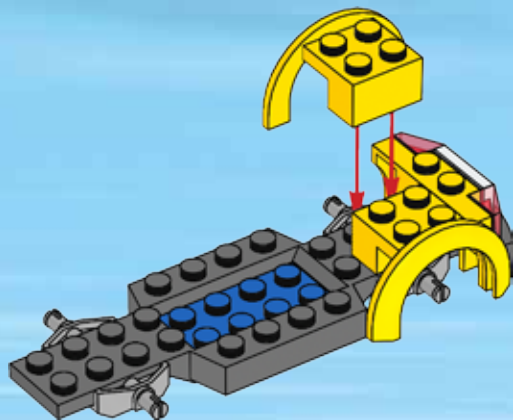

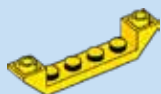

2x

6

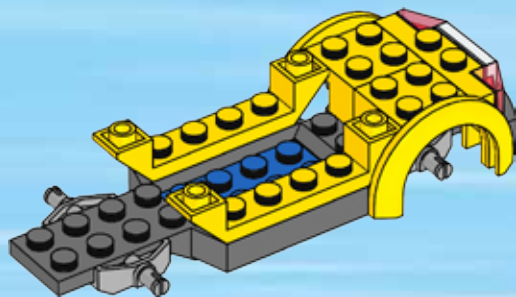

2x

7

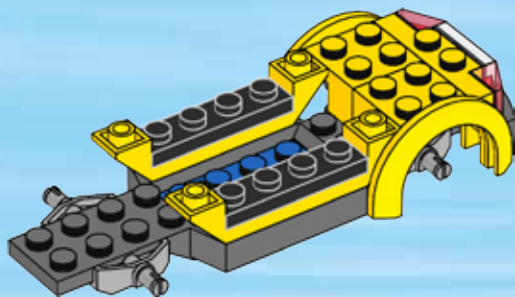



1x

8

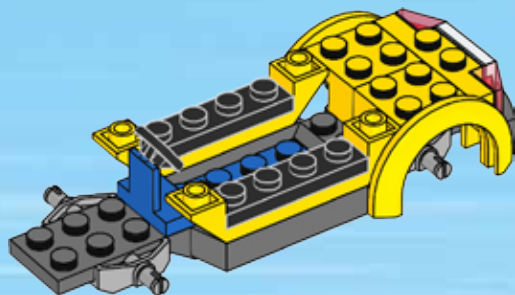



2x

9

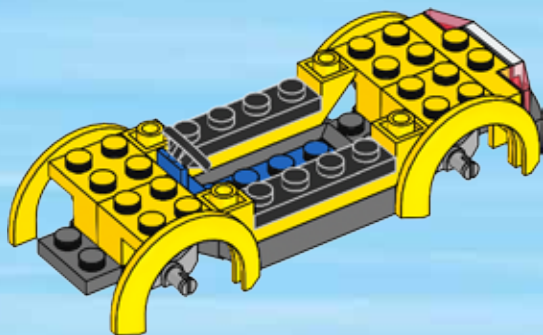

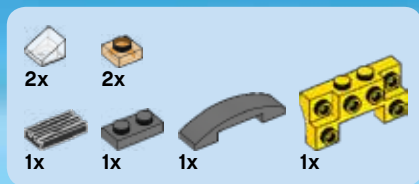

10

1

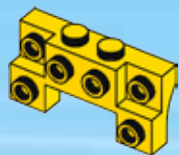

2



3



4



5

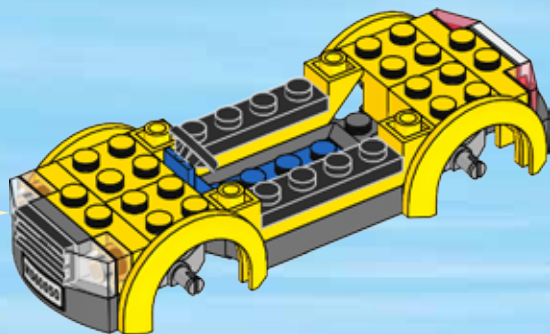
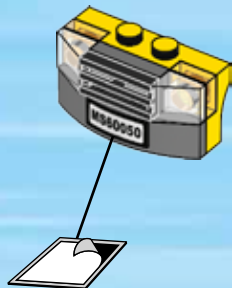



2x

11

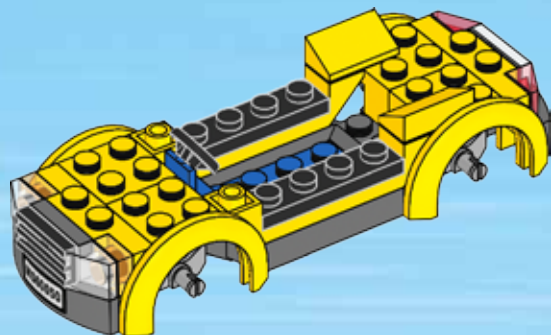



1x



1x

12

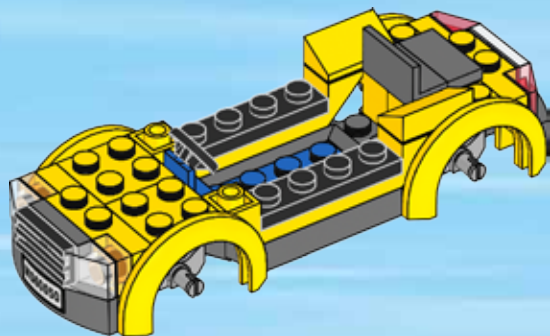

2x

13

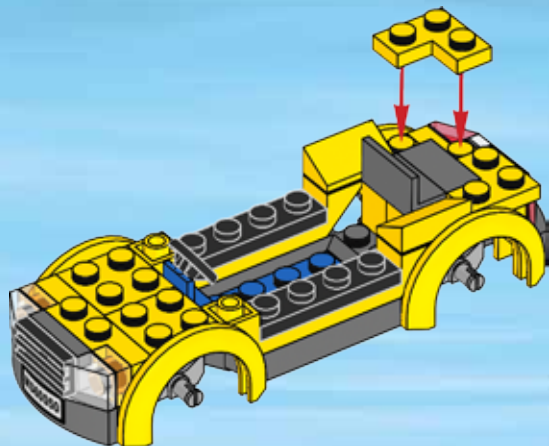



2x



1x

14

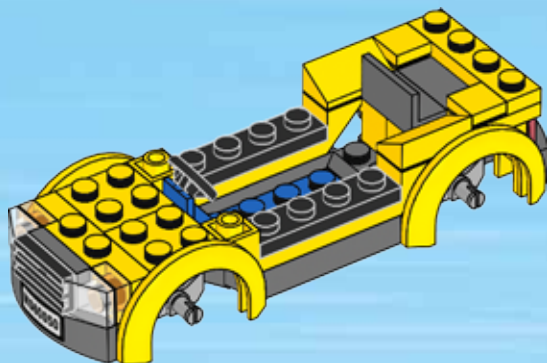



2x

15

1

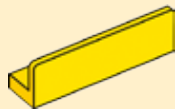

2



2x

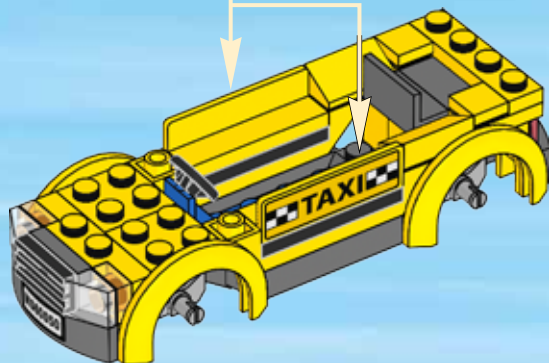



1x



2x

16

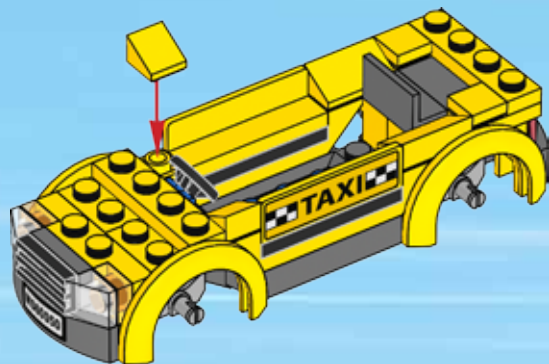

2x

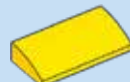

1x

17

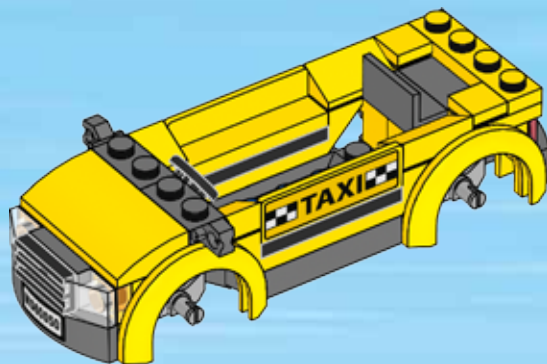



2x

18

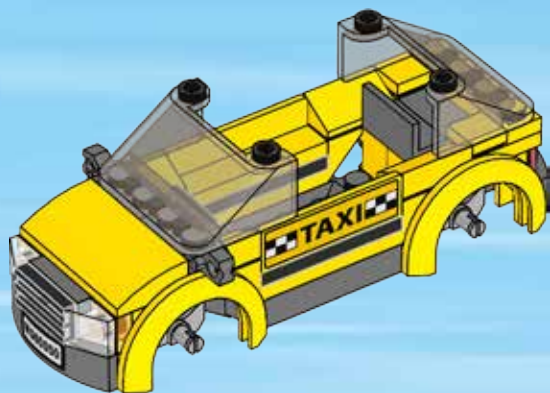

1x

19

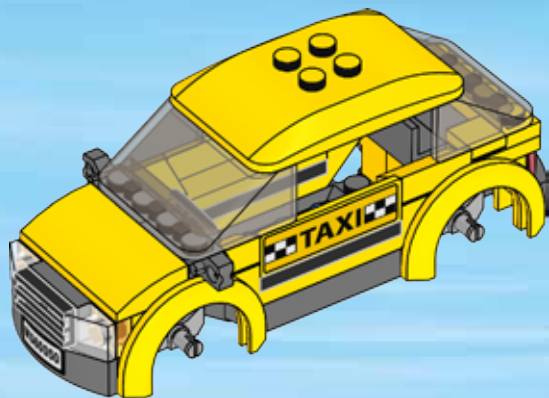



1x

1



2



20

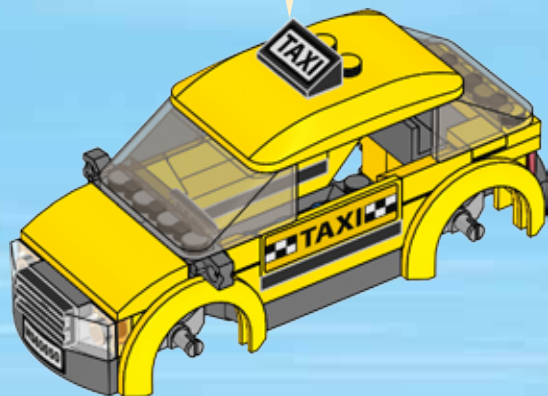



4x



4x



4x



21



22



LEGO CITY



60110



60109



60108



60107



60106



60105

 LEGO.com/city



CITY



60051



60052



60050

LEGO.COM/CITY

WIN

GO TO WWW.LEGO.COM/PRODUCTFEEDBACK AND
GIVE US YOUR SHORT **FEEDBACK** ABOUT THIS
LEGO® SET FOR A CHANCE TO WIN
A COOL LEGO PRIZE.



LEGO.com/productfeedback

GEWINNE



Erzähle uns auf
www.LEGO.com/productfeedback

etwas über die Erfahrungen, die du mit
diesem LEGO® Set gemacht hast, und
sichere dir die Chance auf einen coolen
LEGO Preis!

GAGNE



Rends-toi sur
www.LEGO.com/productfeedback

et donne-nous quelques commentaires
sur ce produit LEGO® pour avoir une
chance de gagner un prix LEGO !

GANAN



Visita
www.LEGO.com/productfeedback

y envíanos tu opinión acerca de este set
LEGO®. ¡Participarás en el sorteo de un
premio LEGO!

获取奖品



登录
www.LEGO.com/productfeedback

给出关于此乐高®套装的简短反馈，
就有机会获得炫酷乐高奖品



CITY

60050



[LEGO.com/city](https://www.lego.com/city)



2

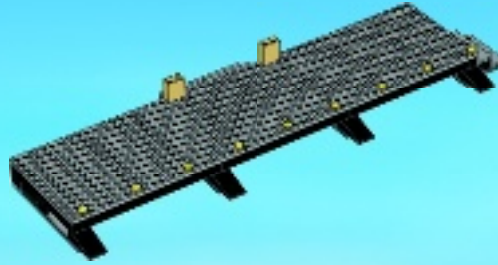

3



4

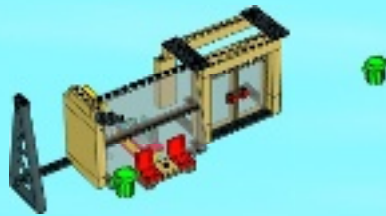

5

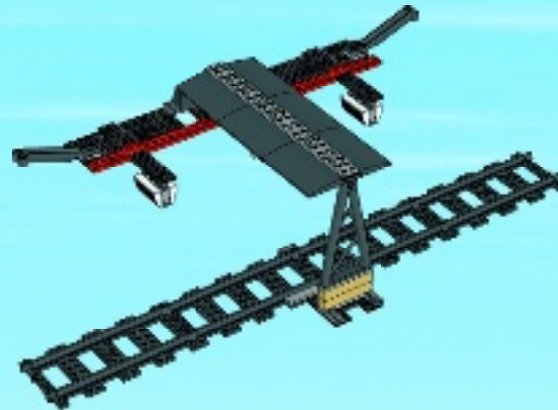

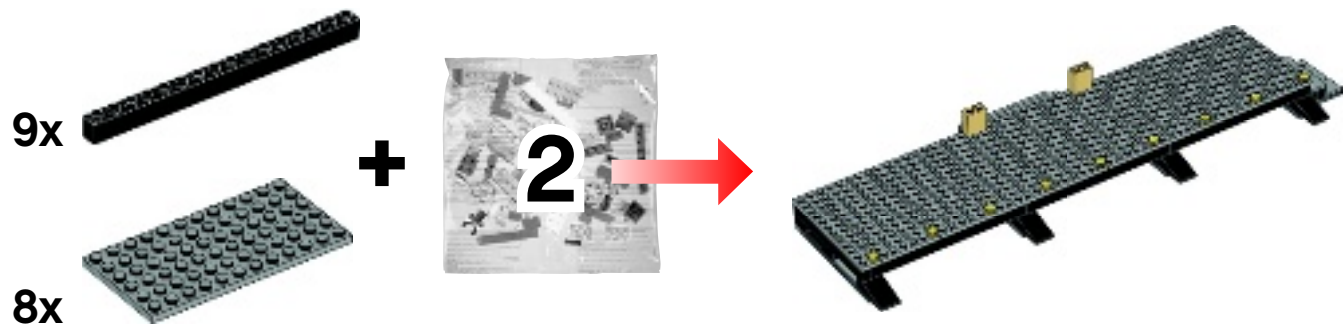

1

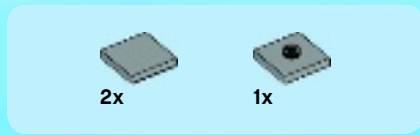

2

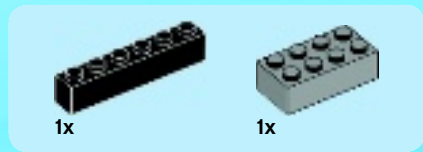

3

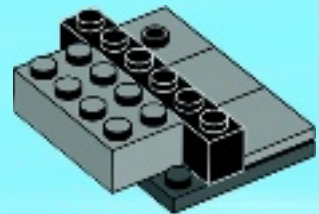



2x

4

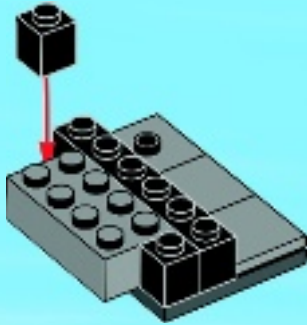

2x



1x

5

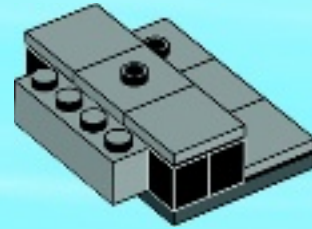

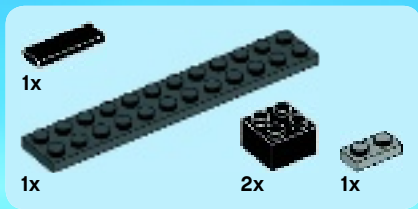

6

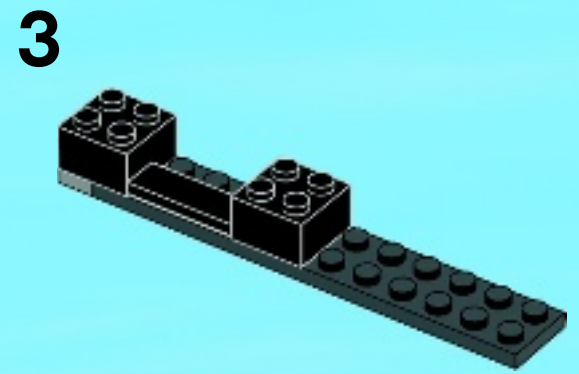
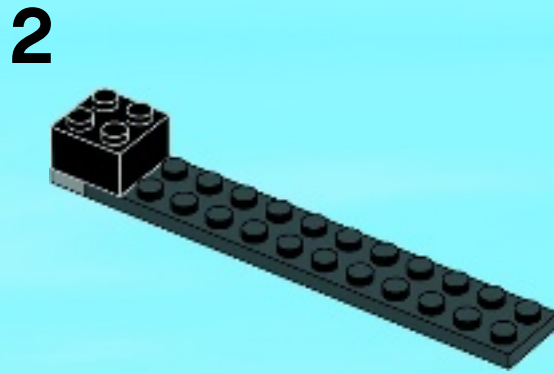
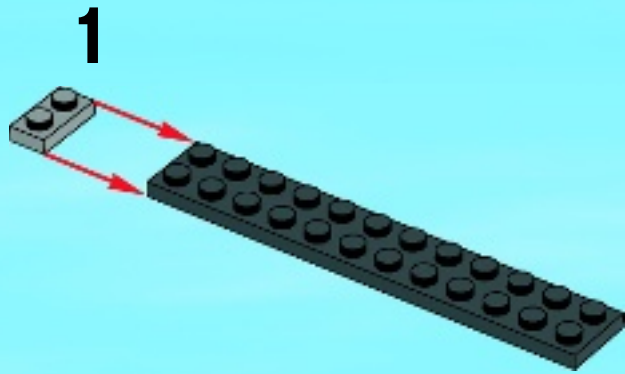



1x

7

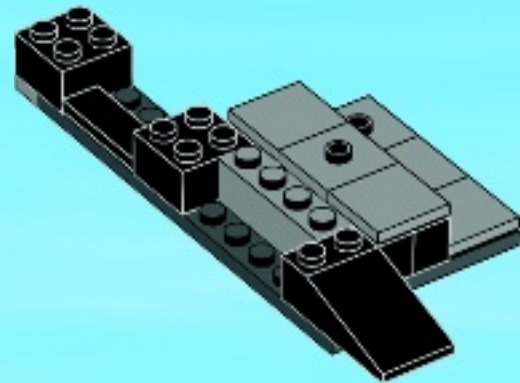
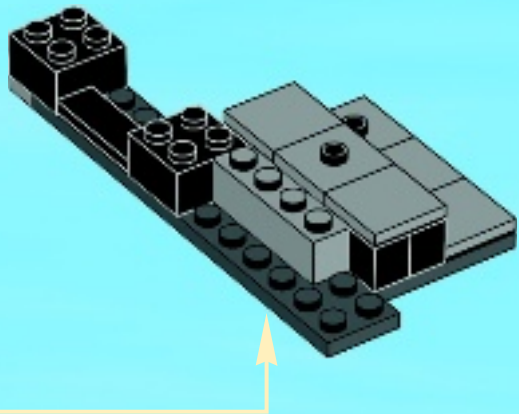



8

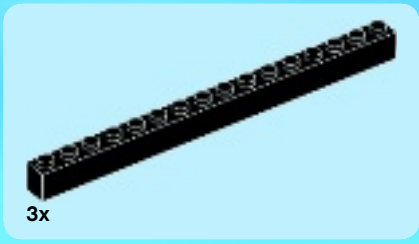
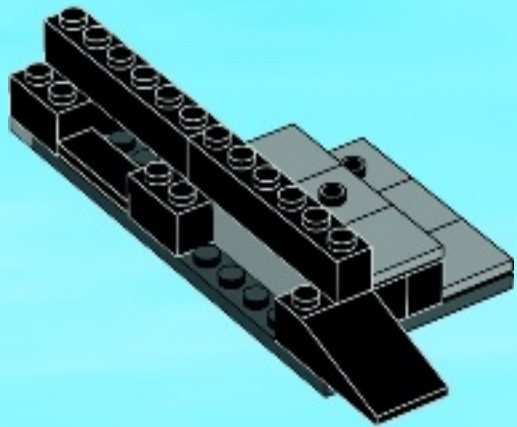

9

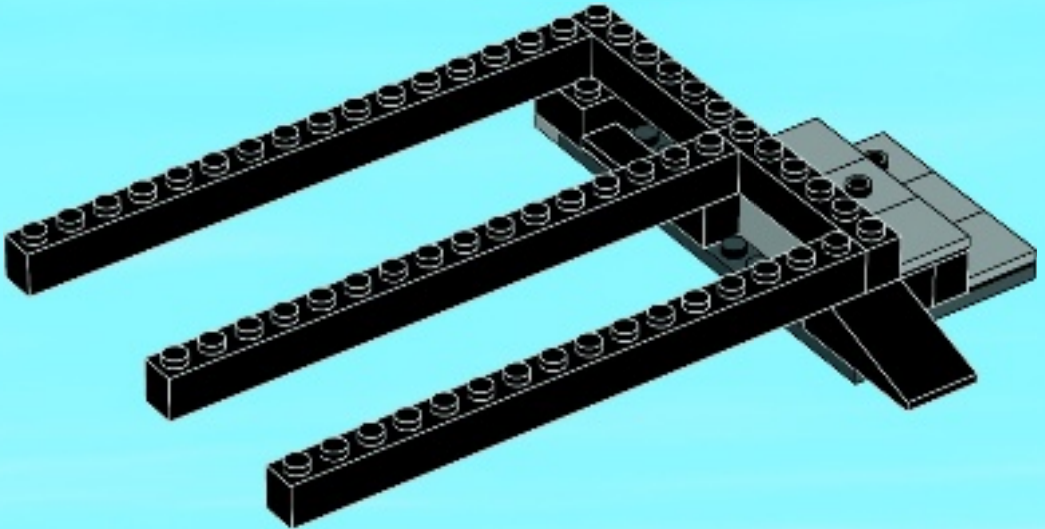

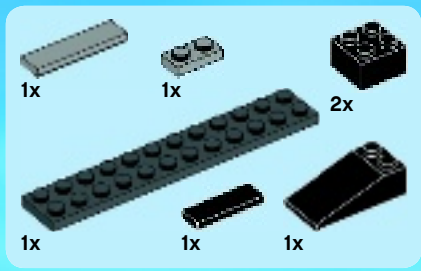

10

1

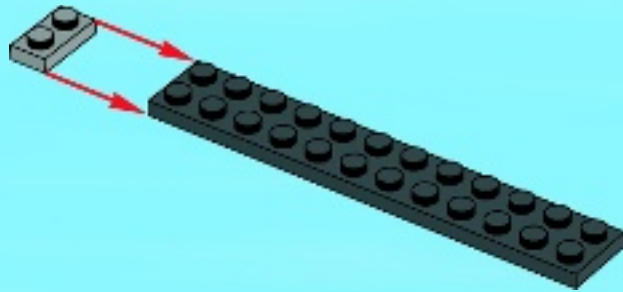

2

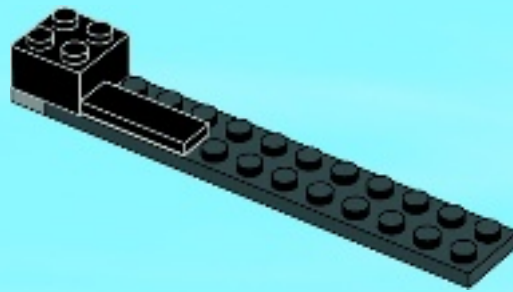

3

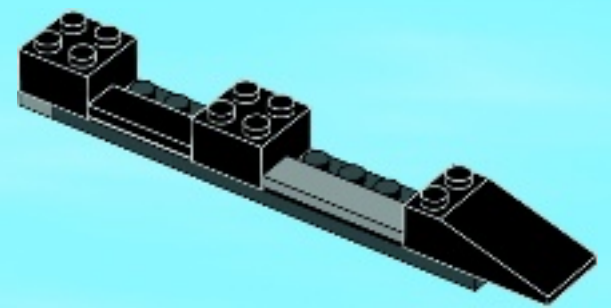

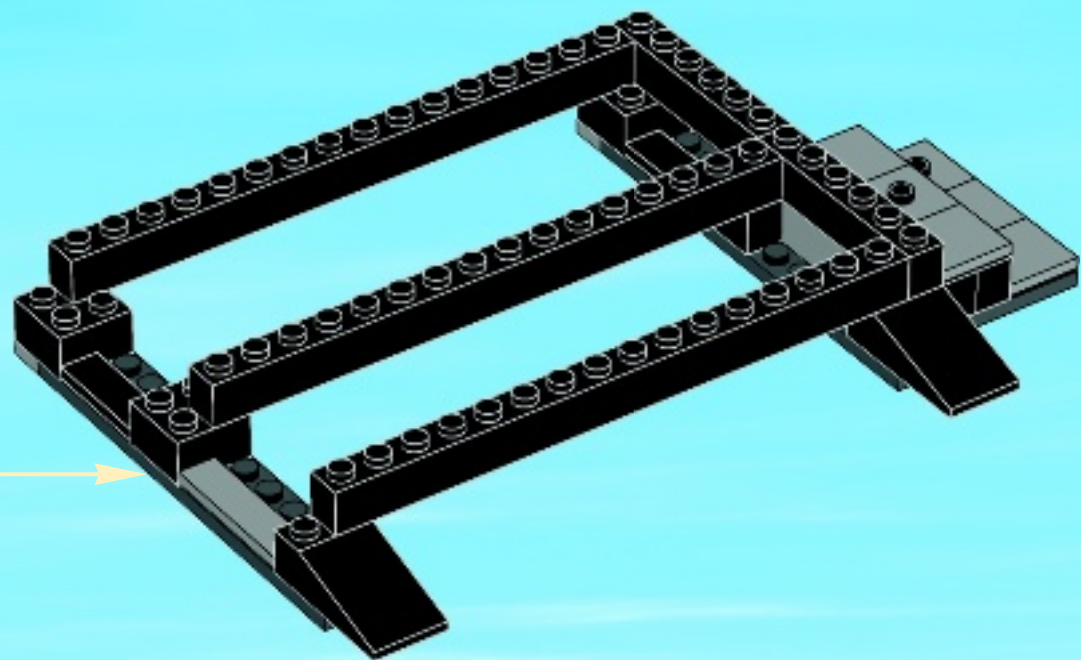

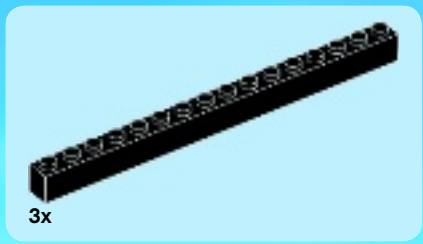

11

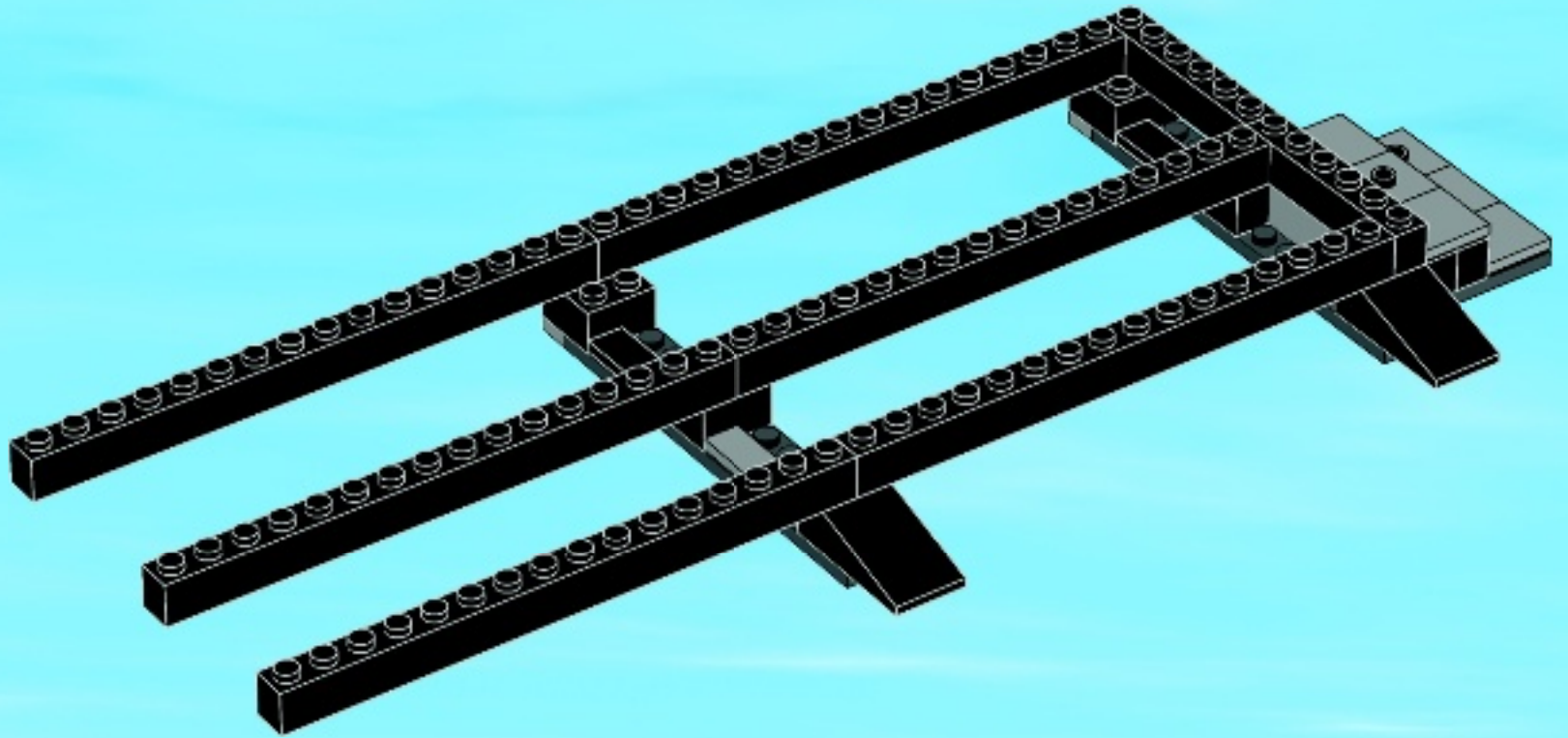

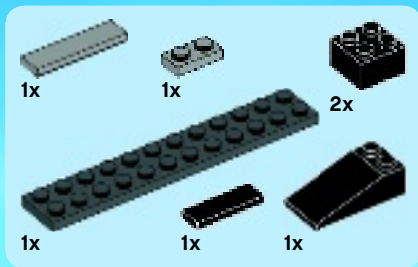

12

1

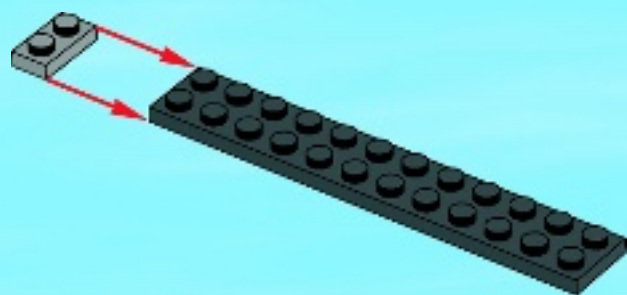

2

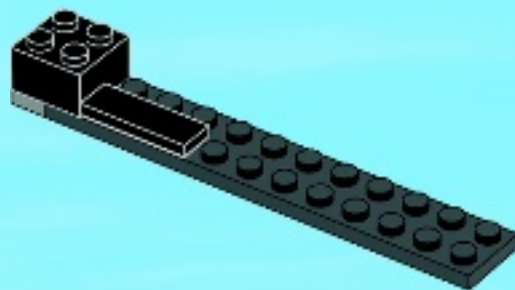

3

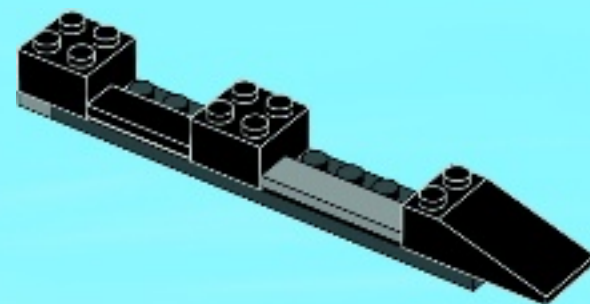

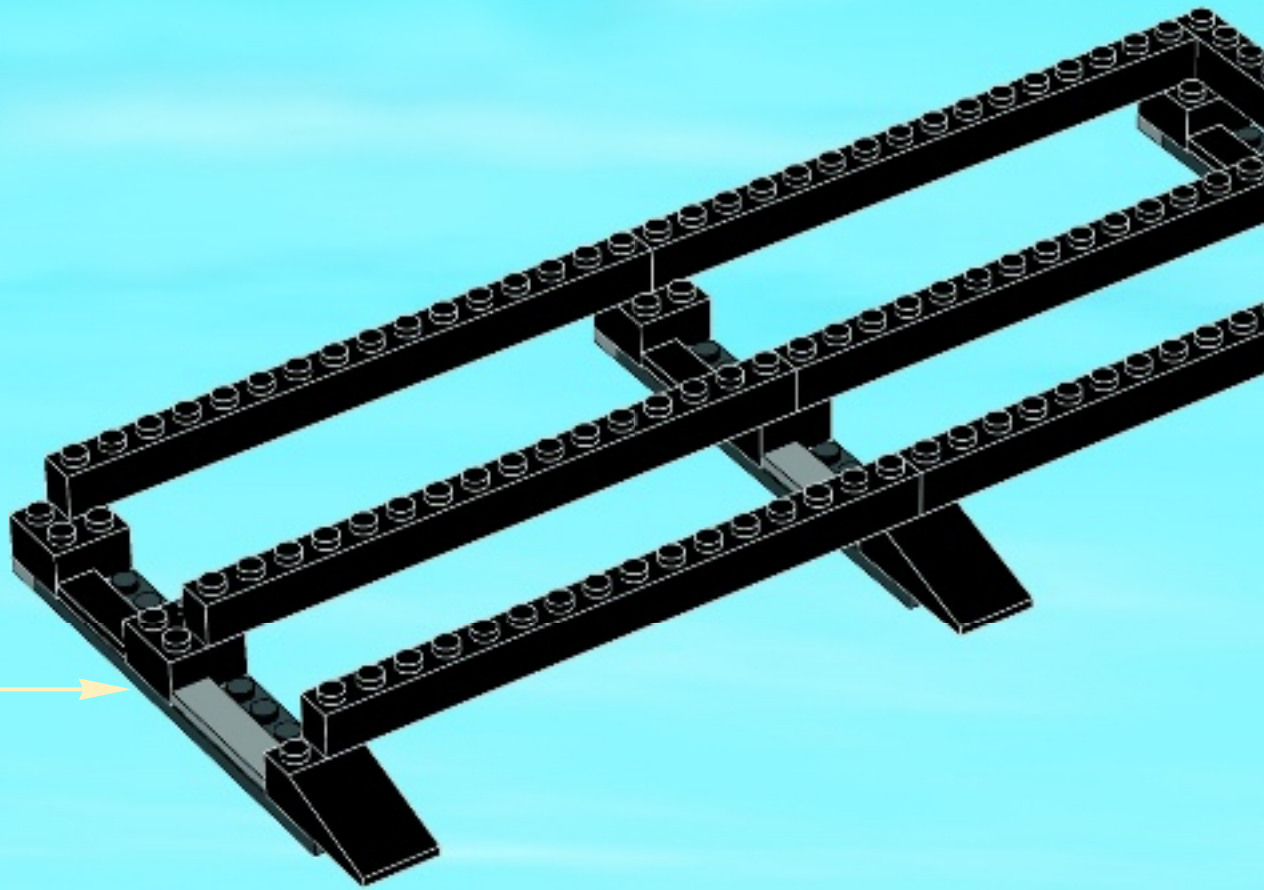



13

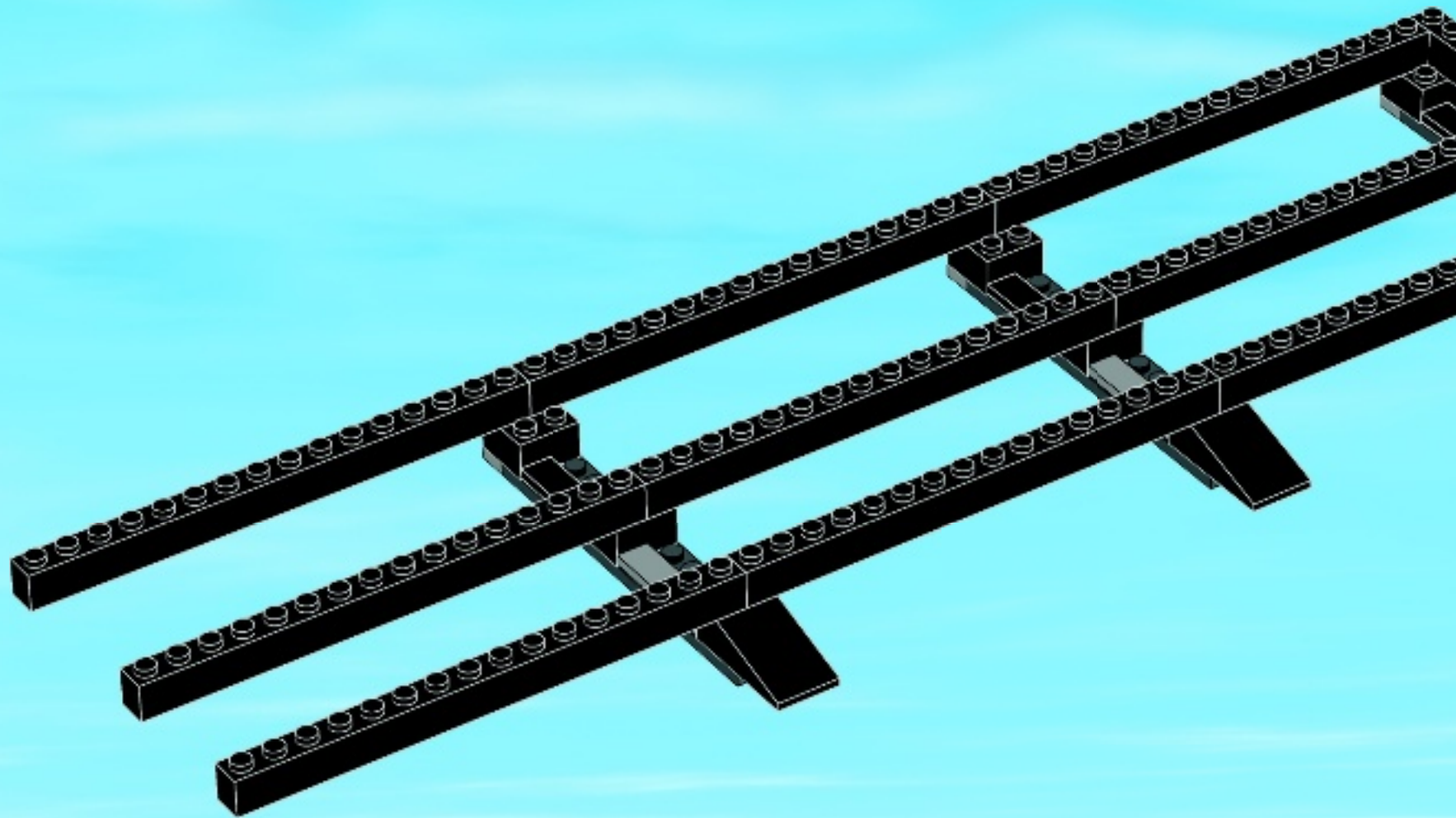

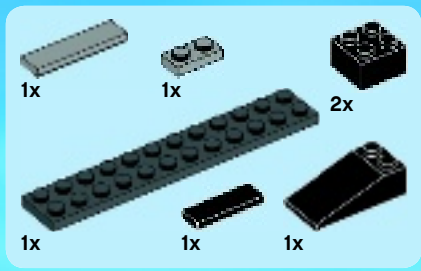

14

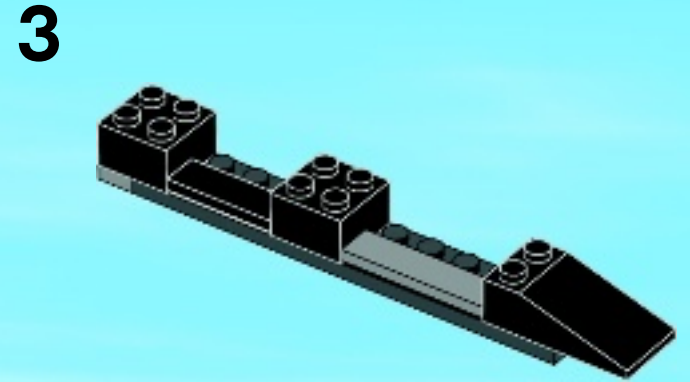
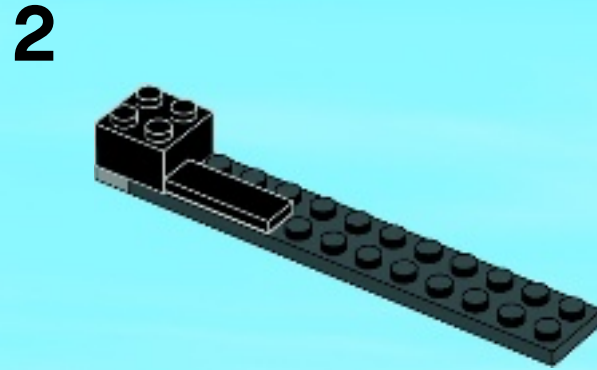
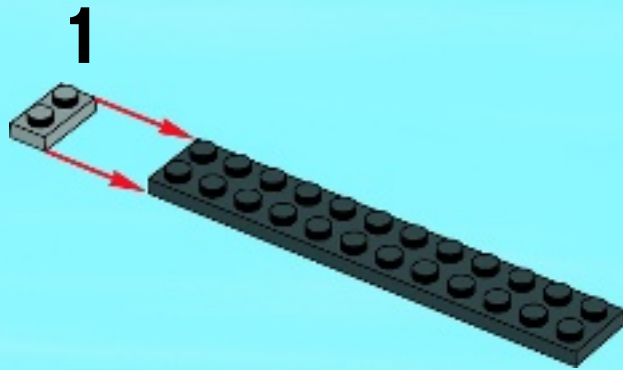

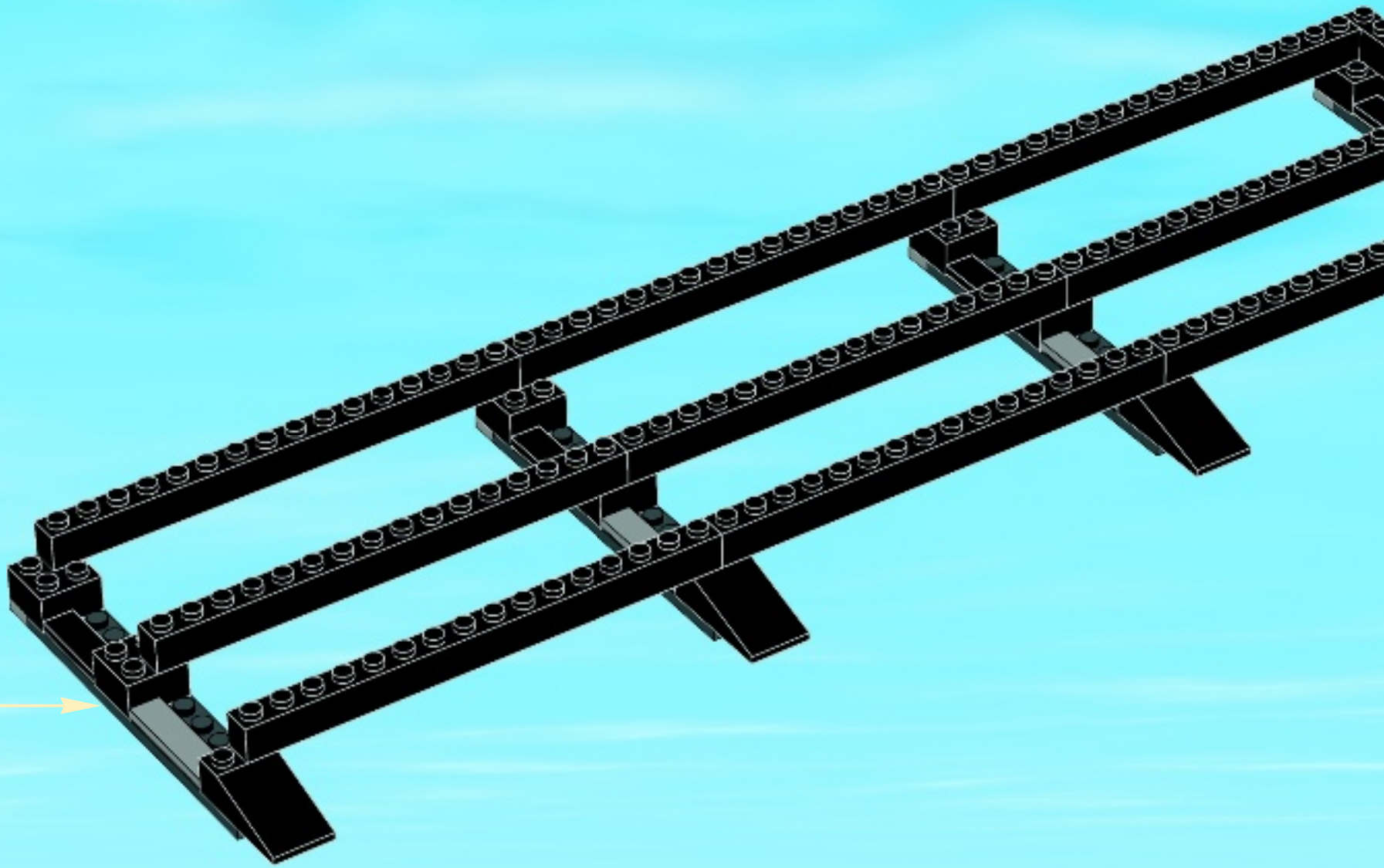



15

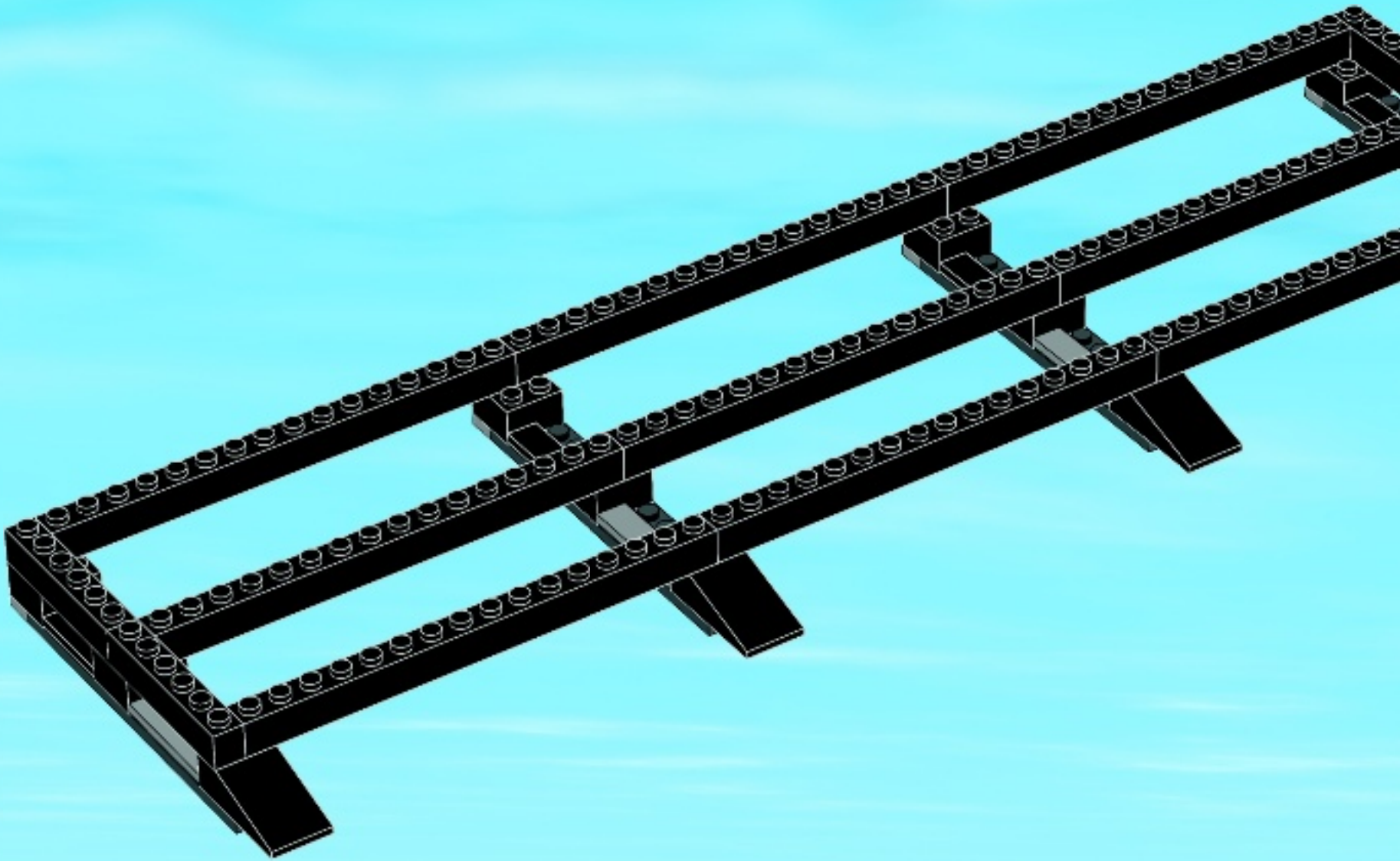

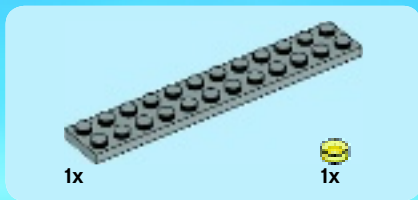

16

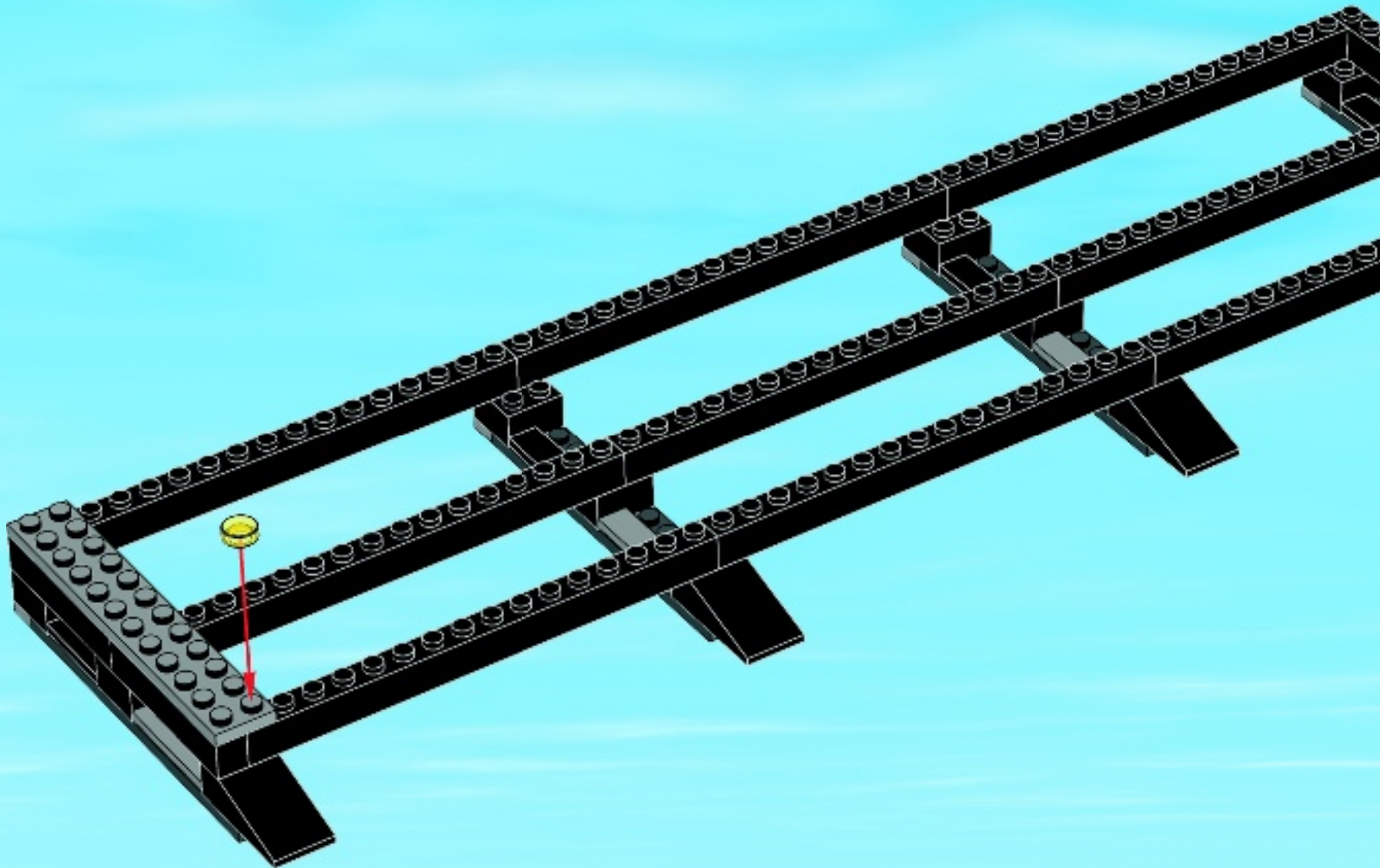

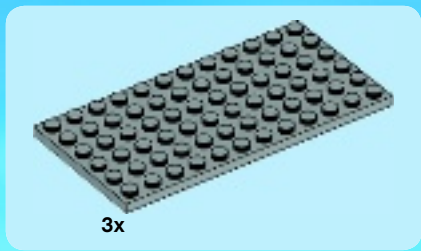

17

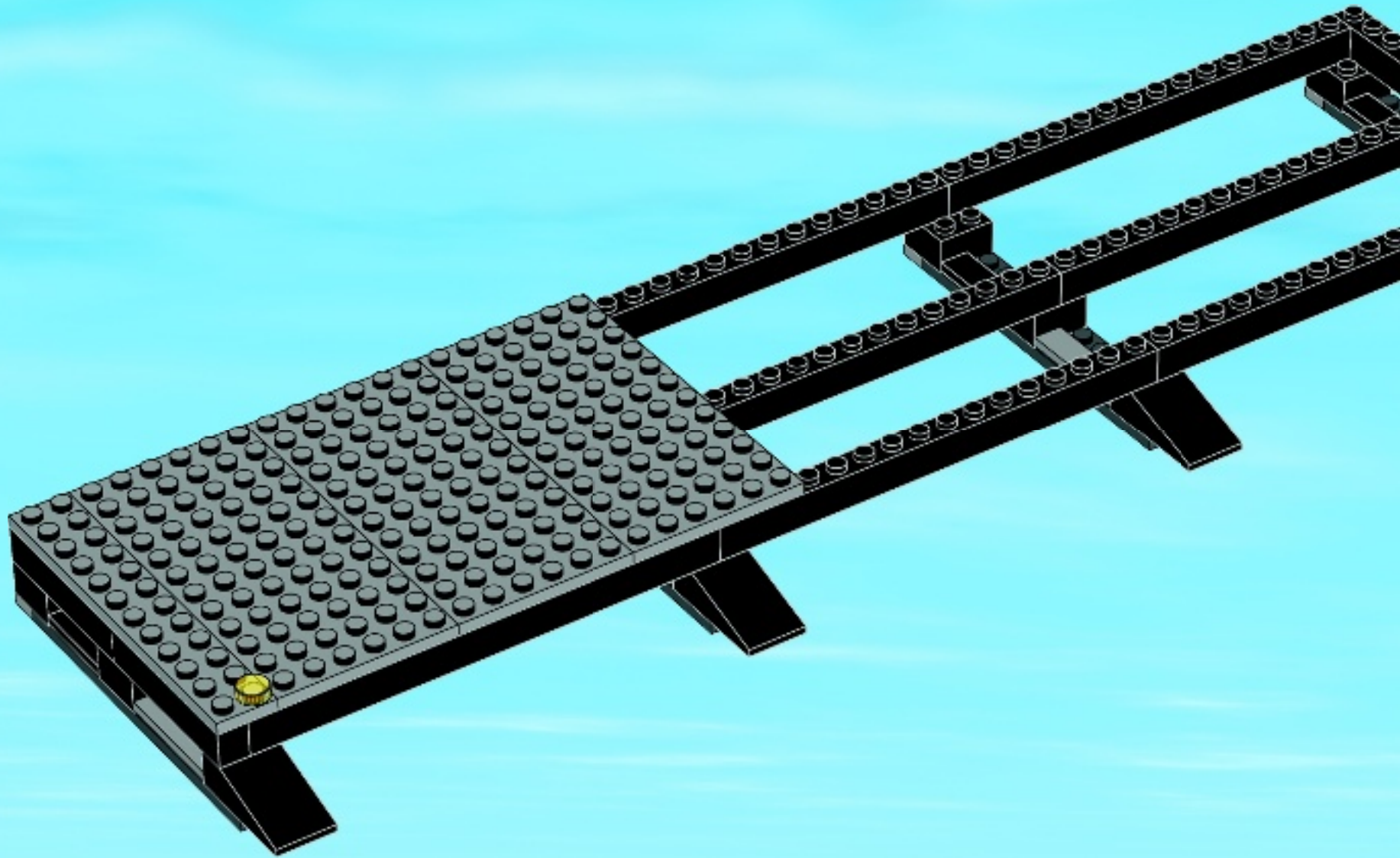



1x



3x

18

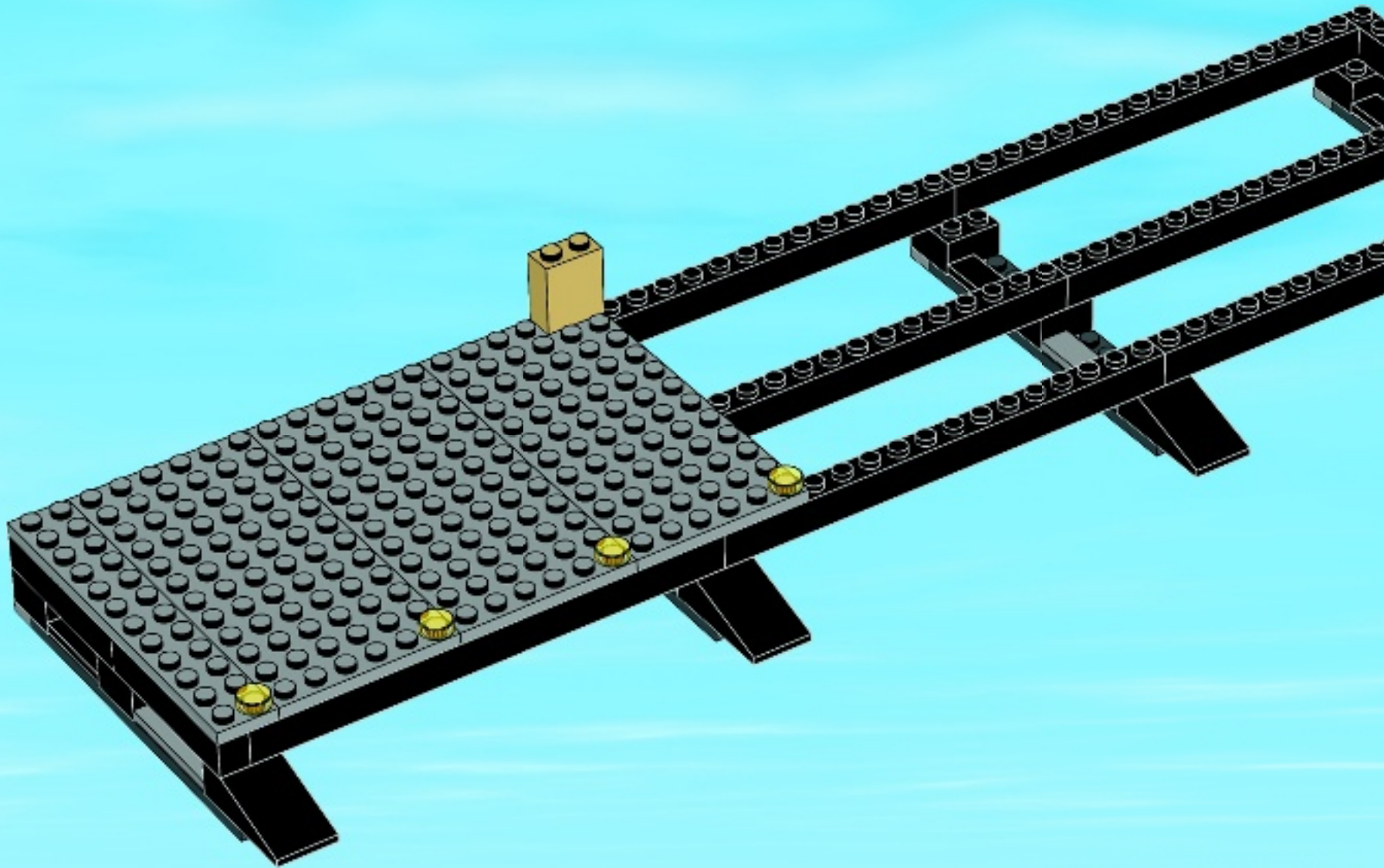

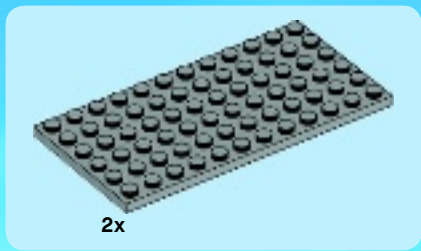

19

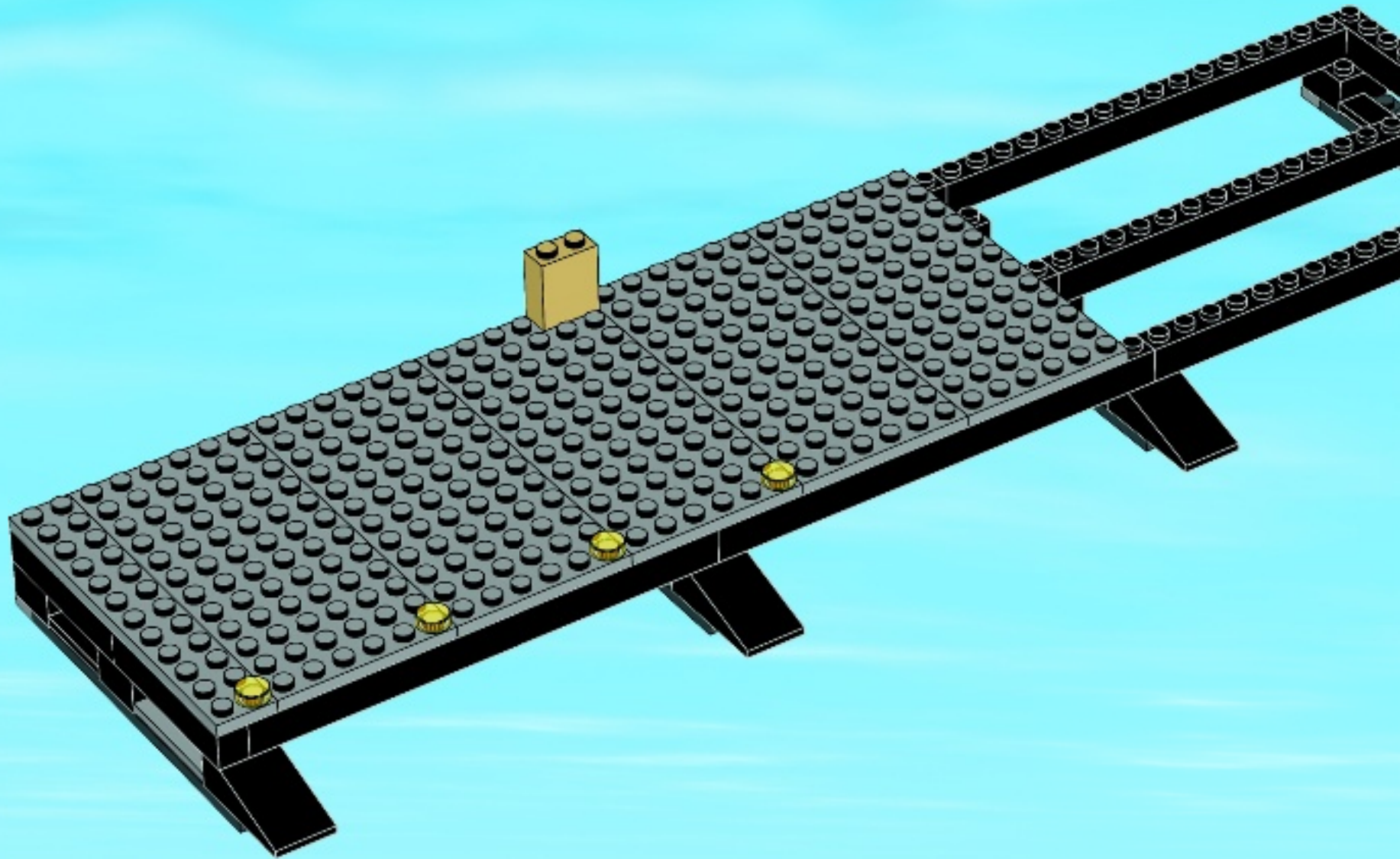



1x



2x

20

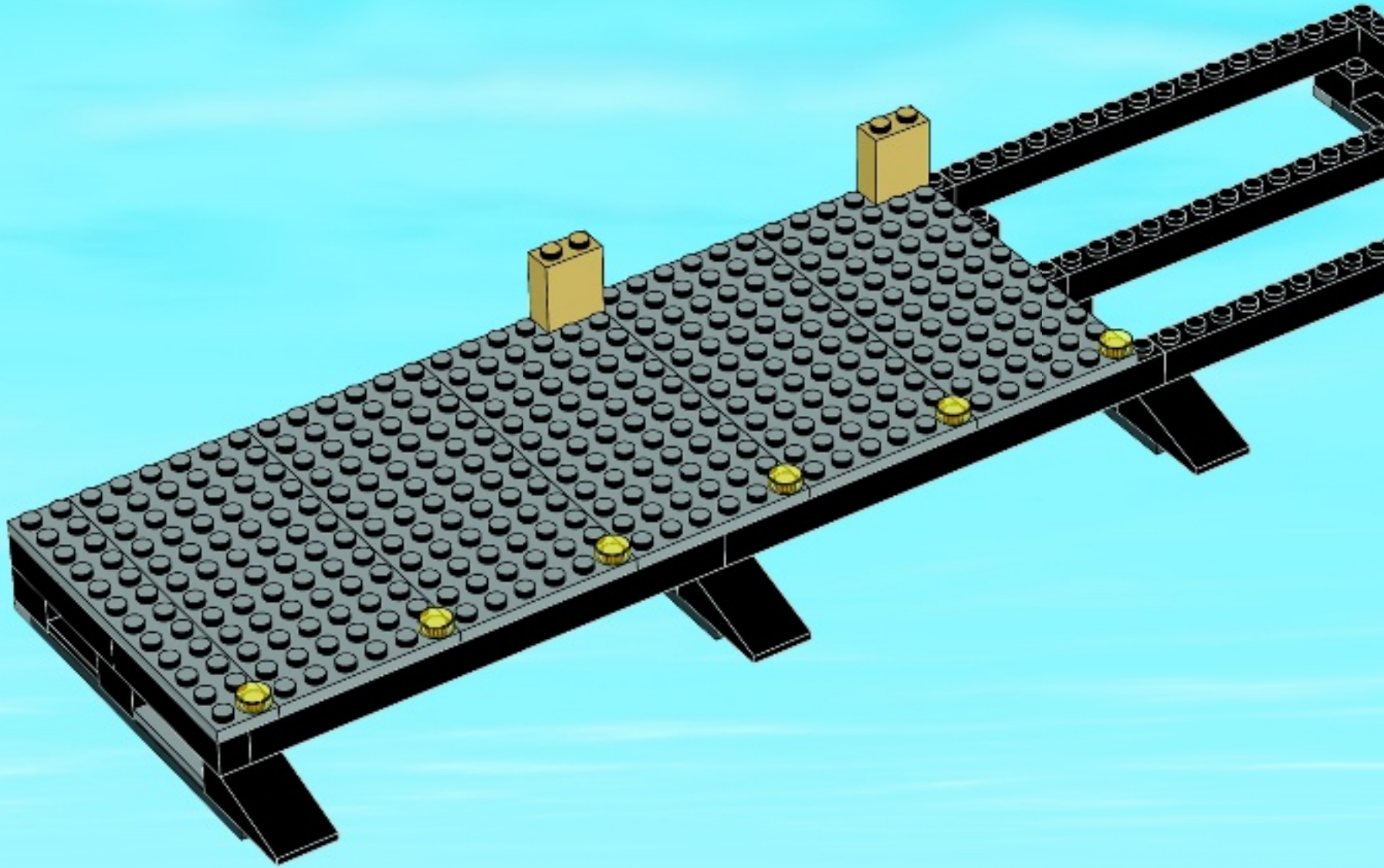

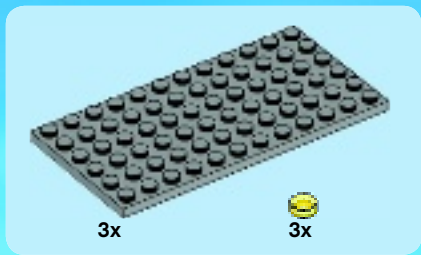

21

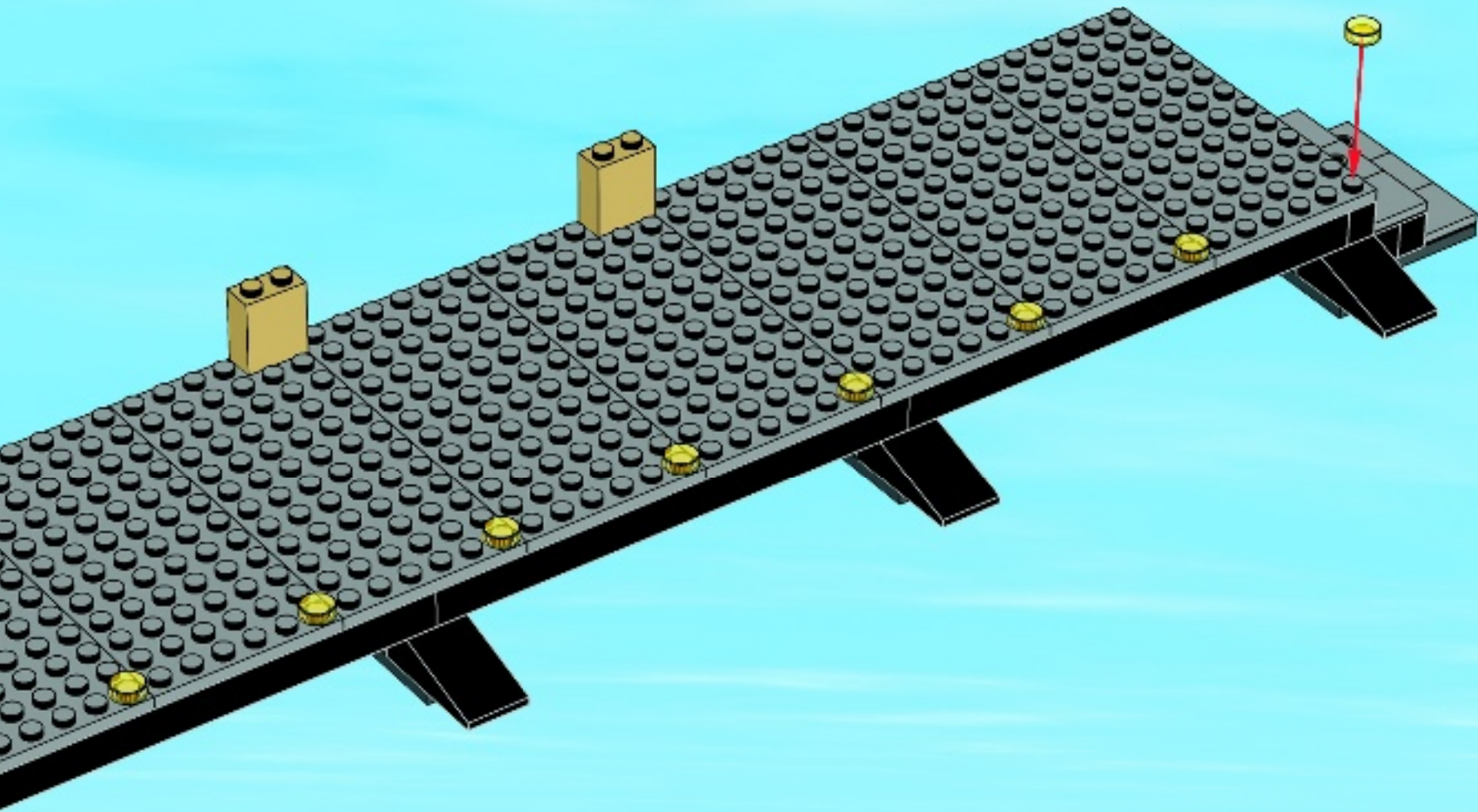

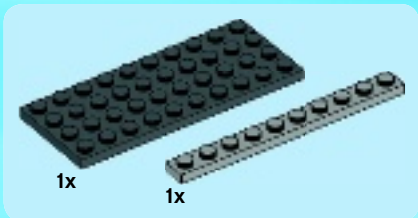
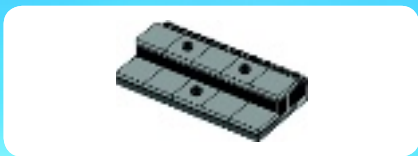

1

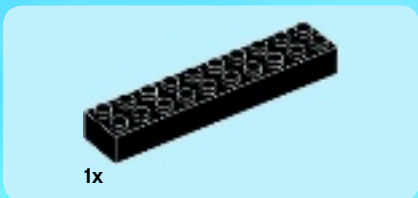
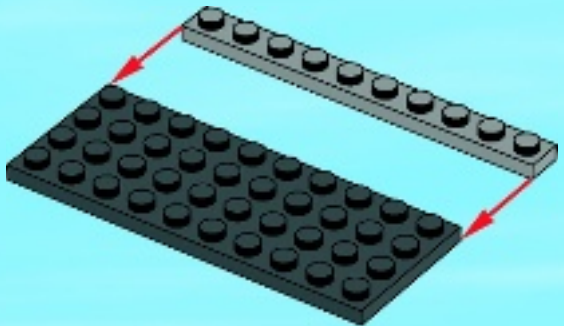

2

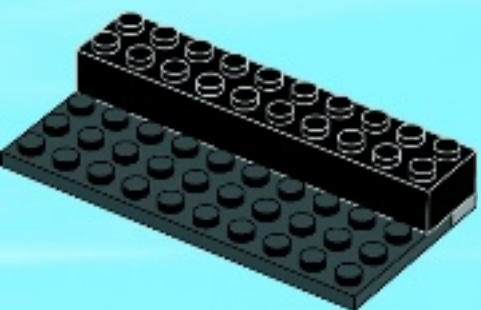

3

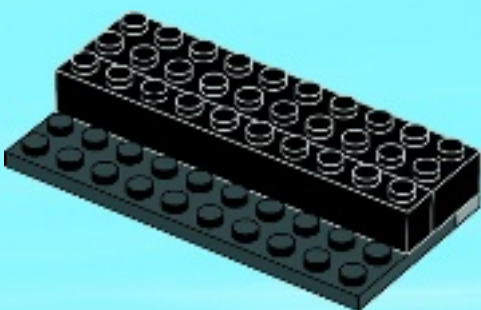



4x



1x

4

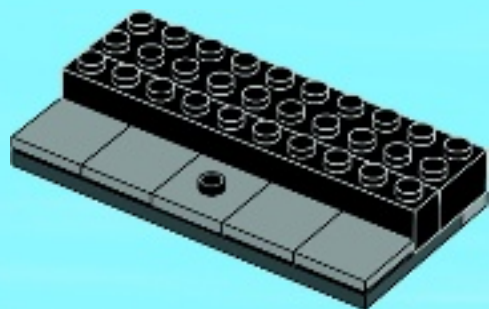

3x



2x

5

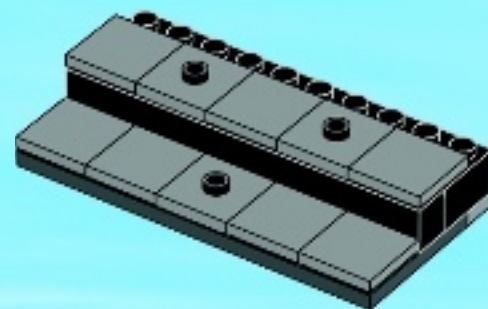

22

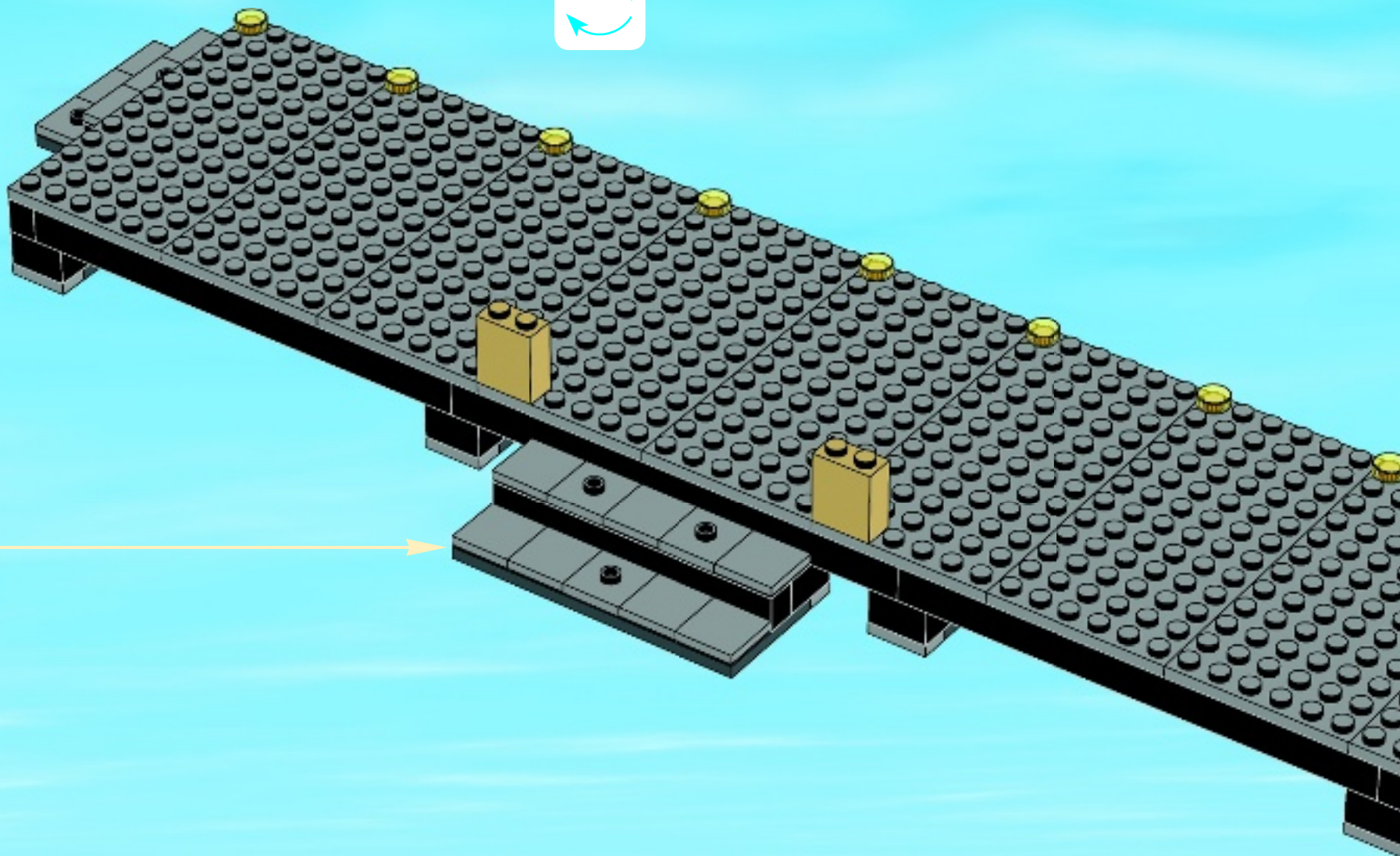

3

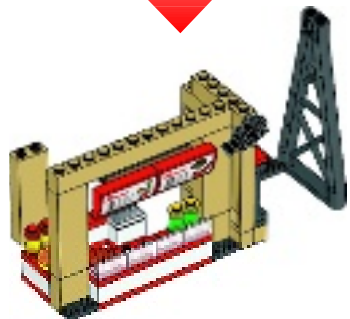

1x

23

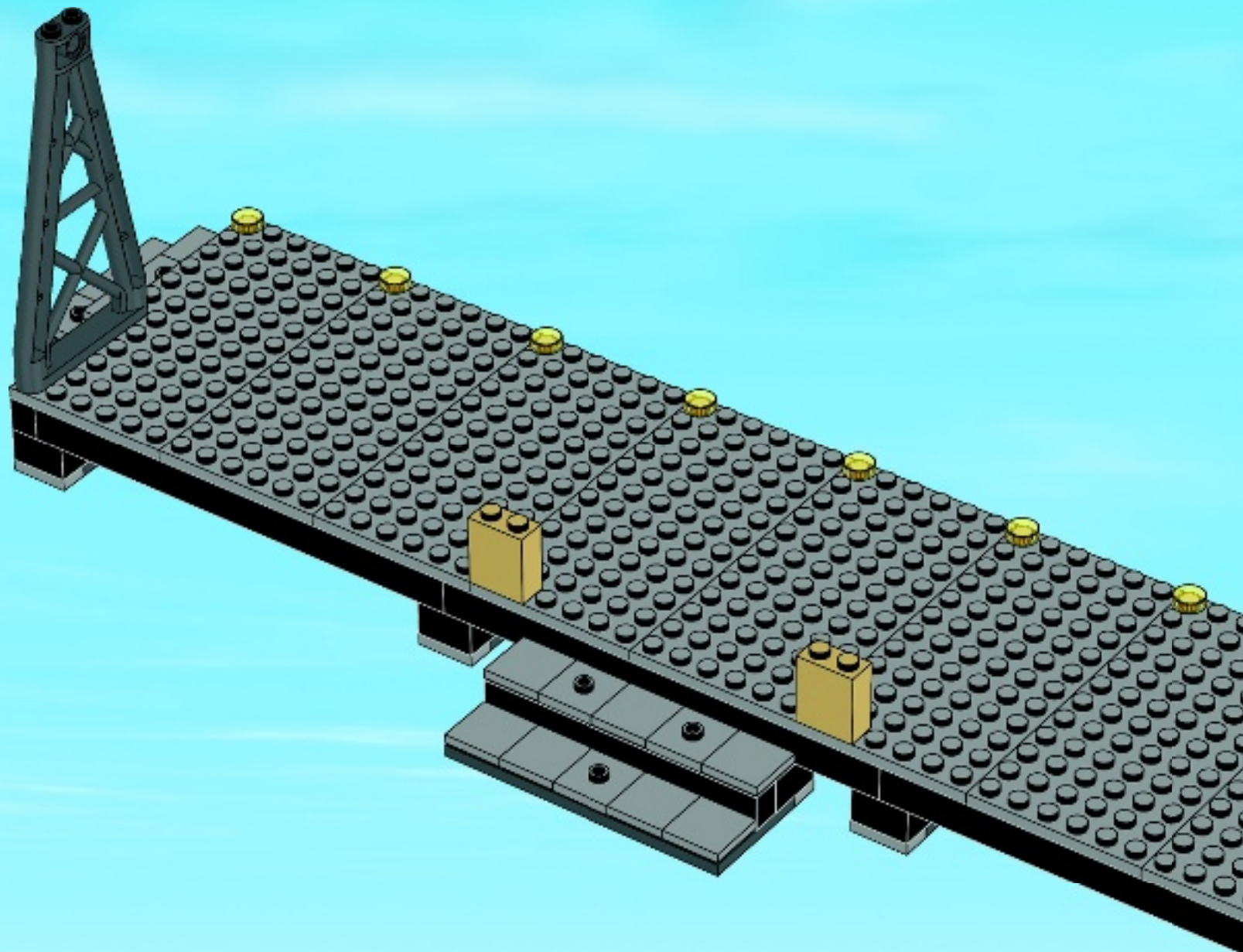



2x

24

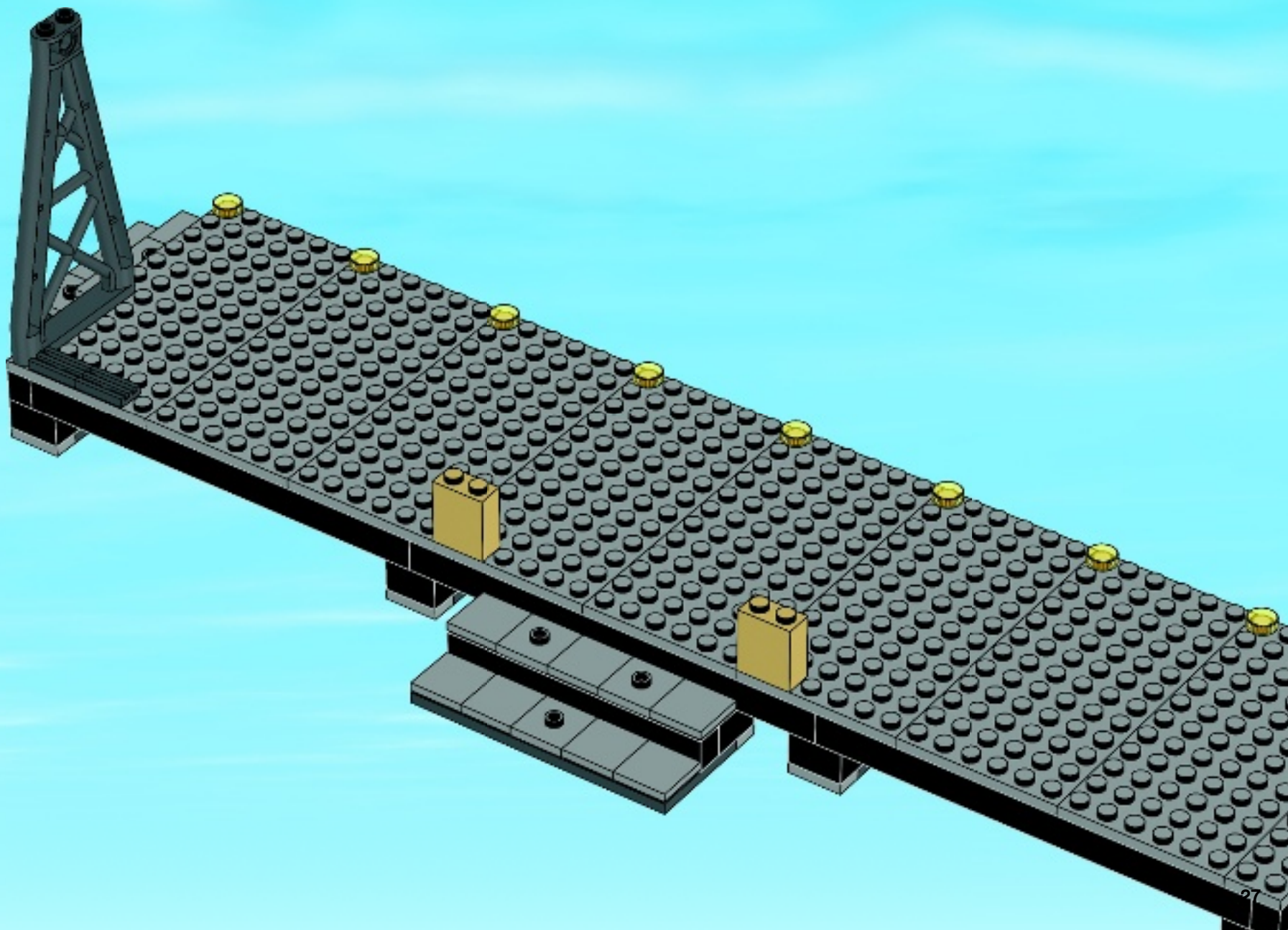

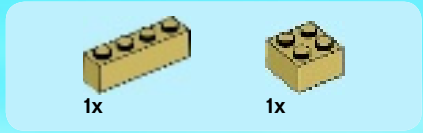

1

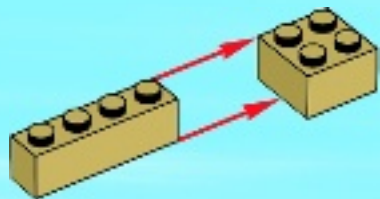

2

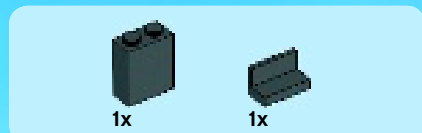
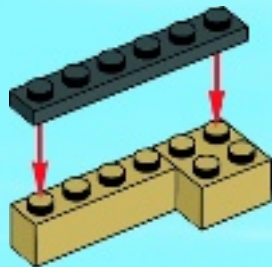

3

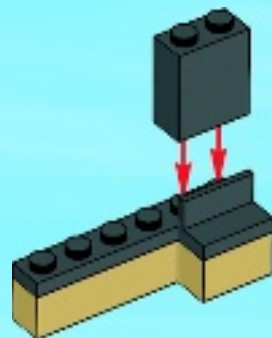

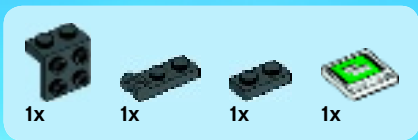

4

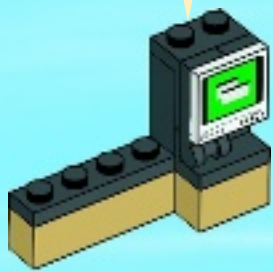
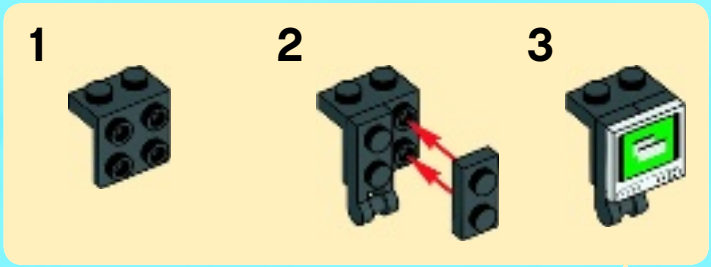

5

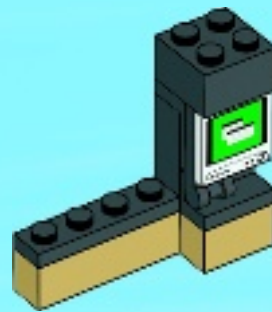

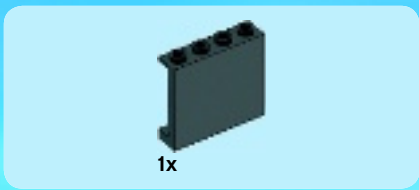

6

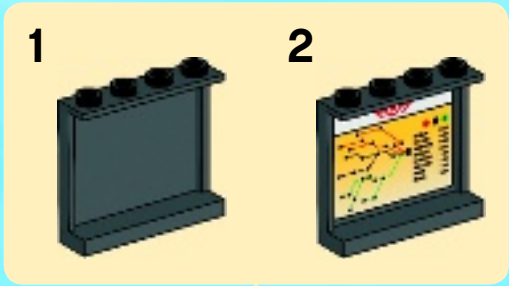

7

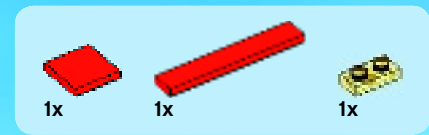

8

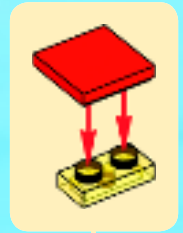

25

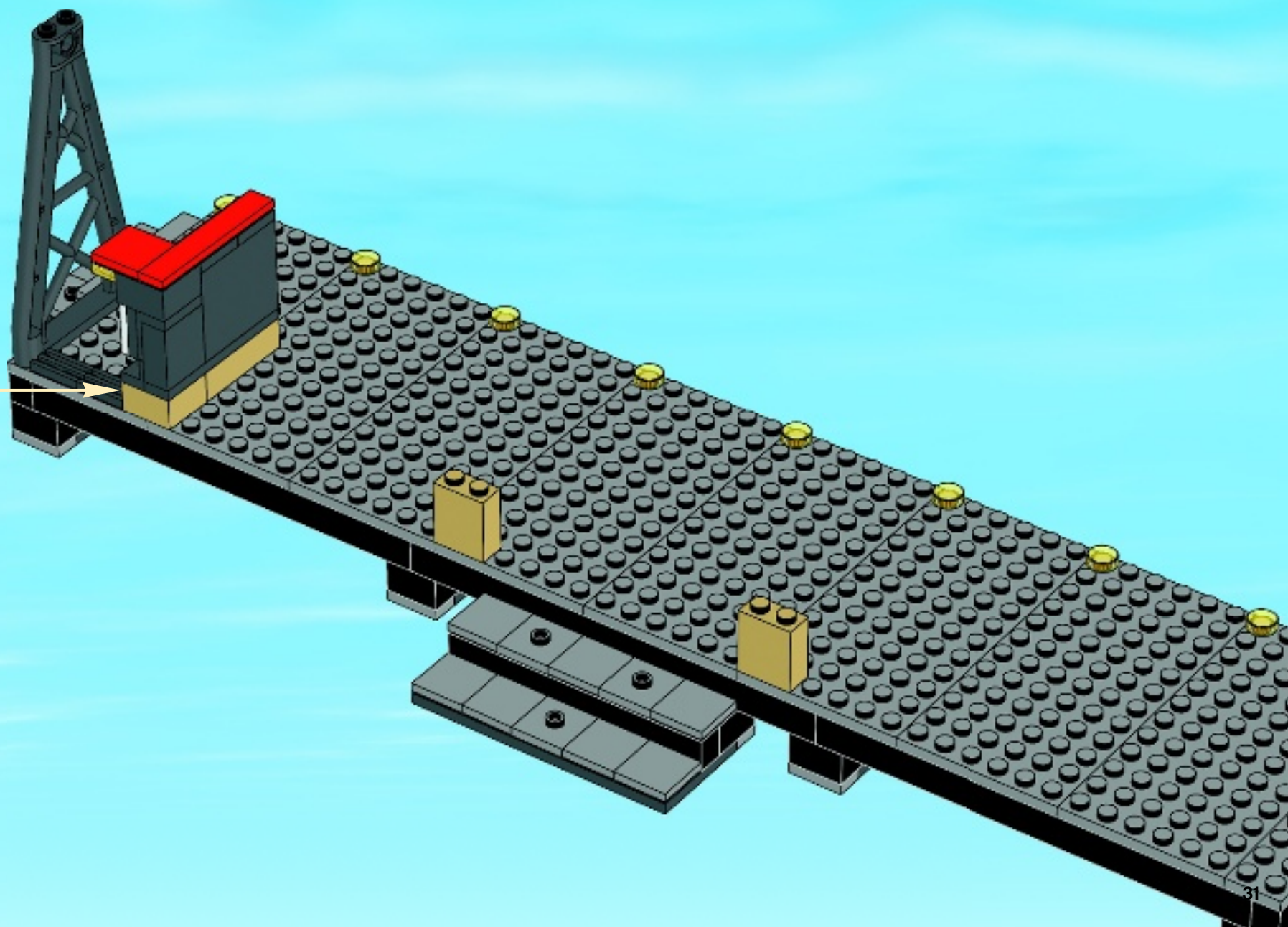



26

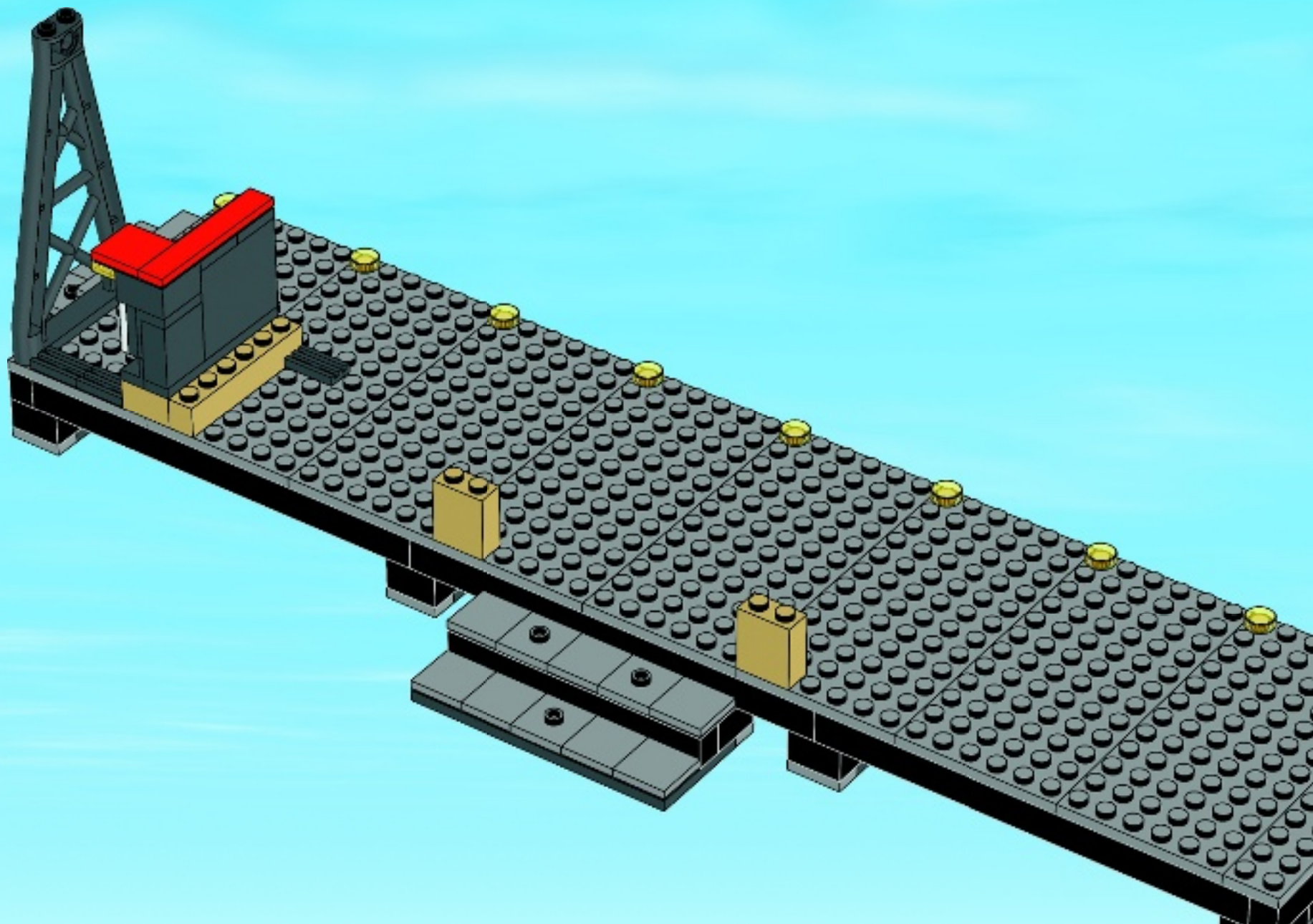

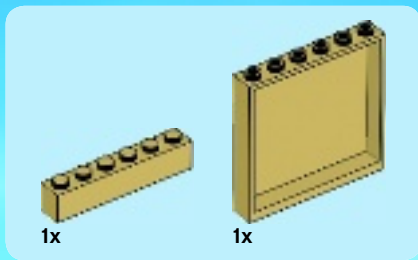

27

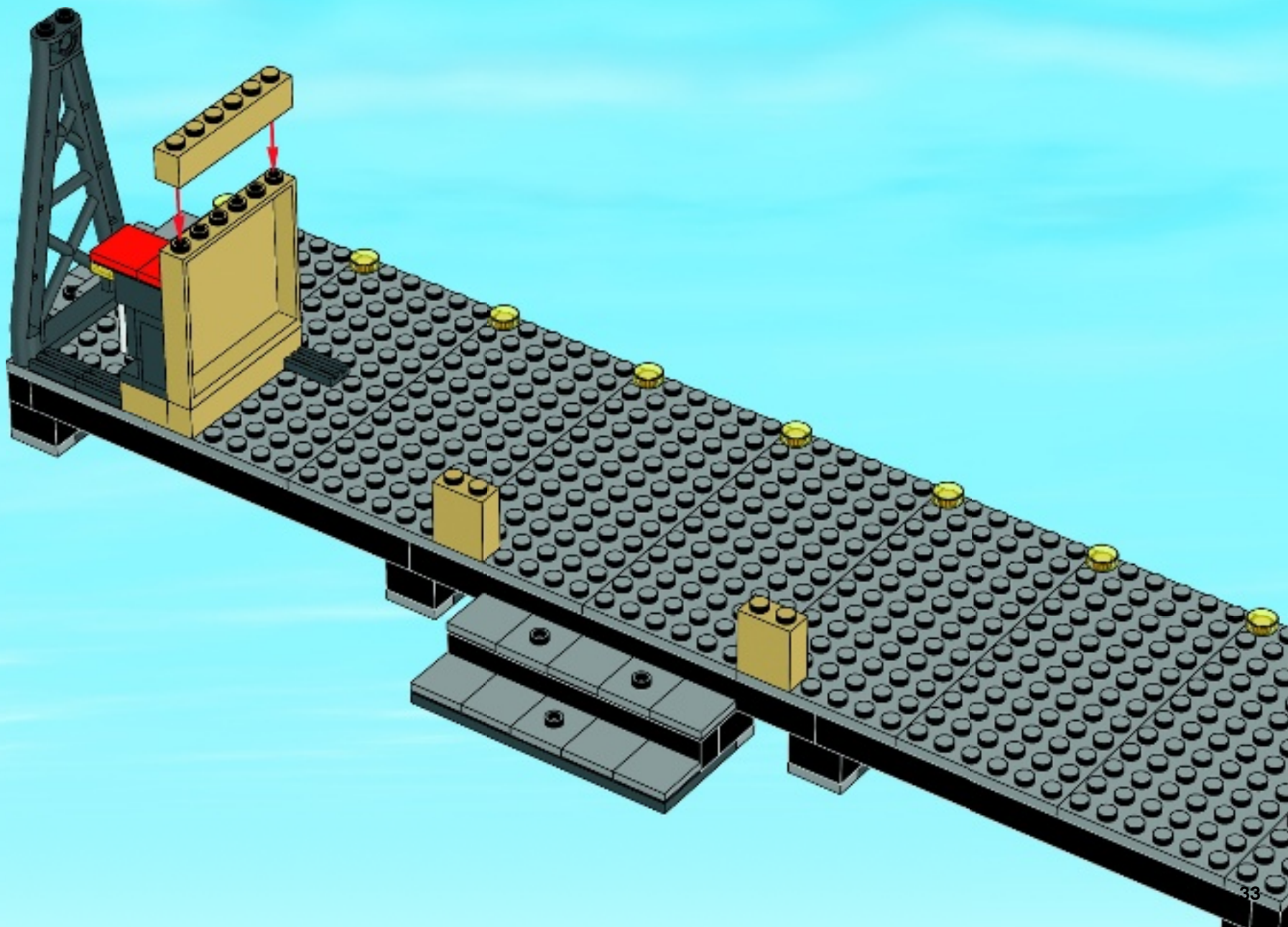



28

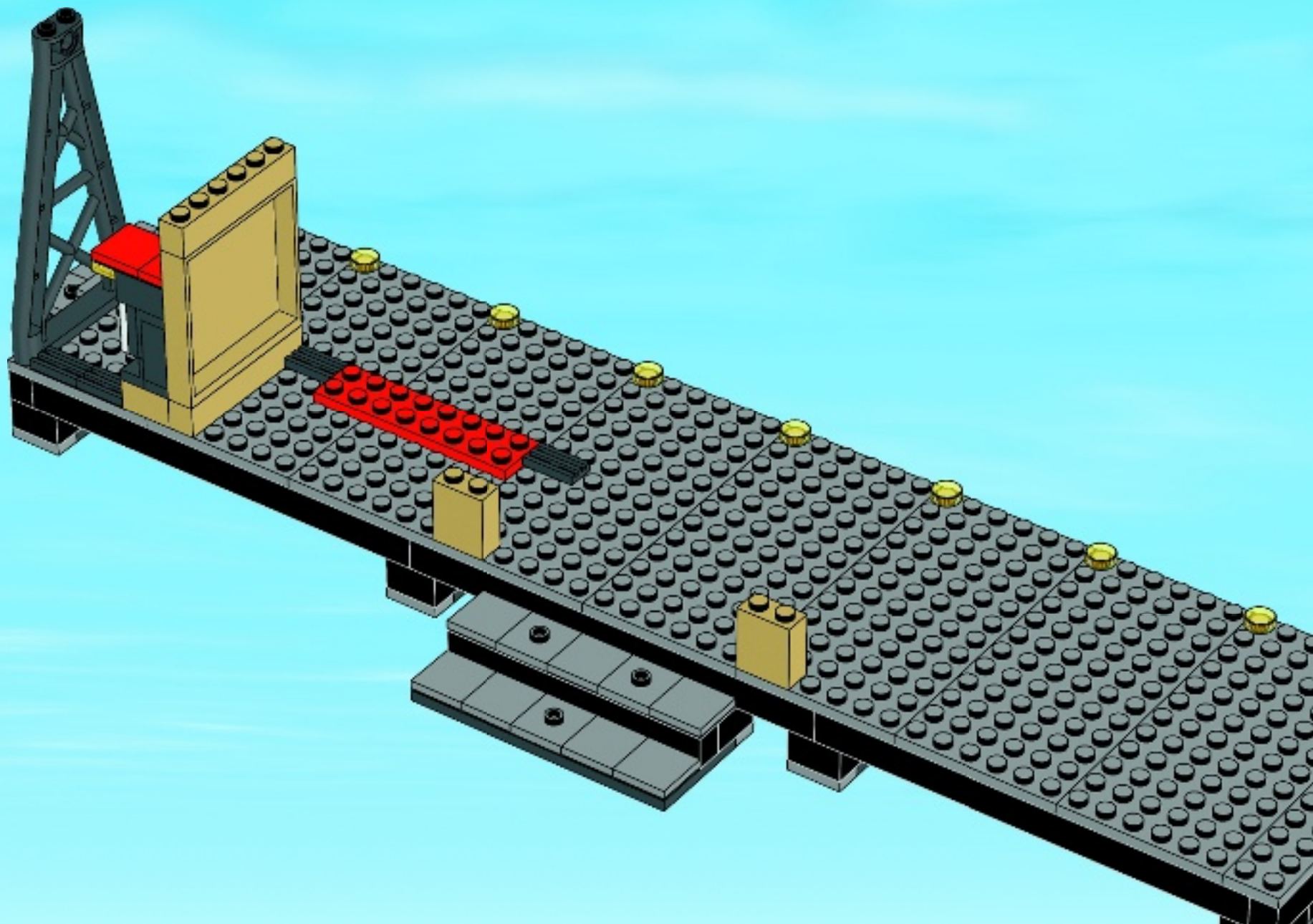



2x

29

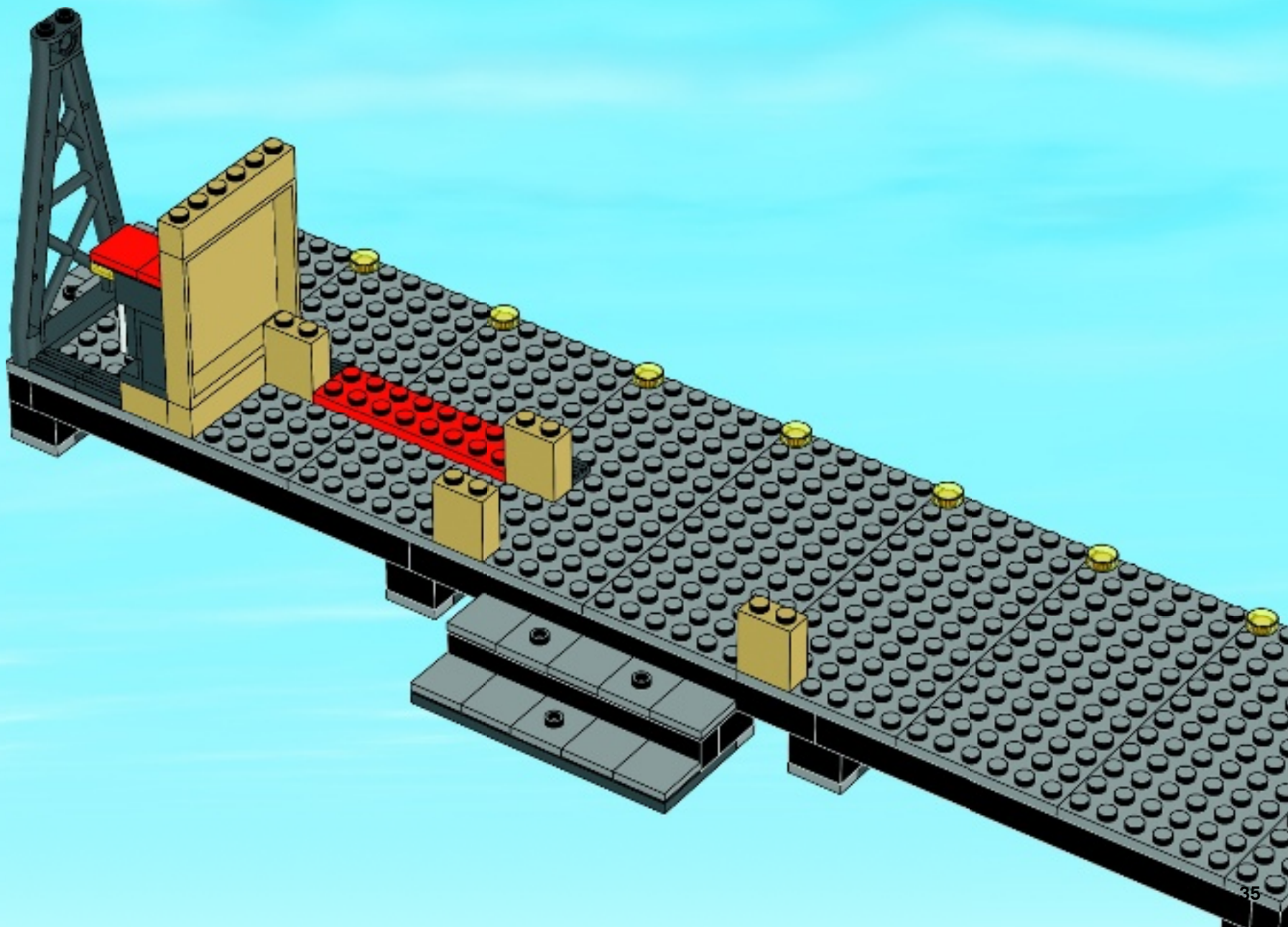

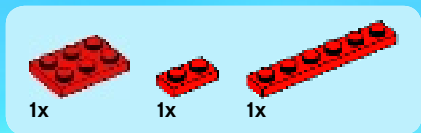

30

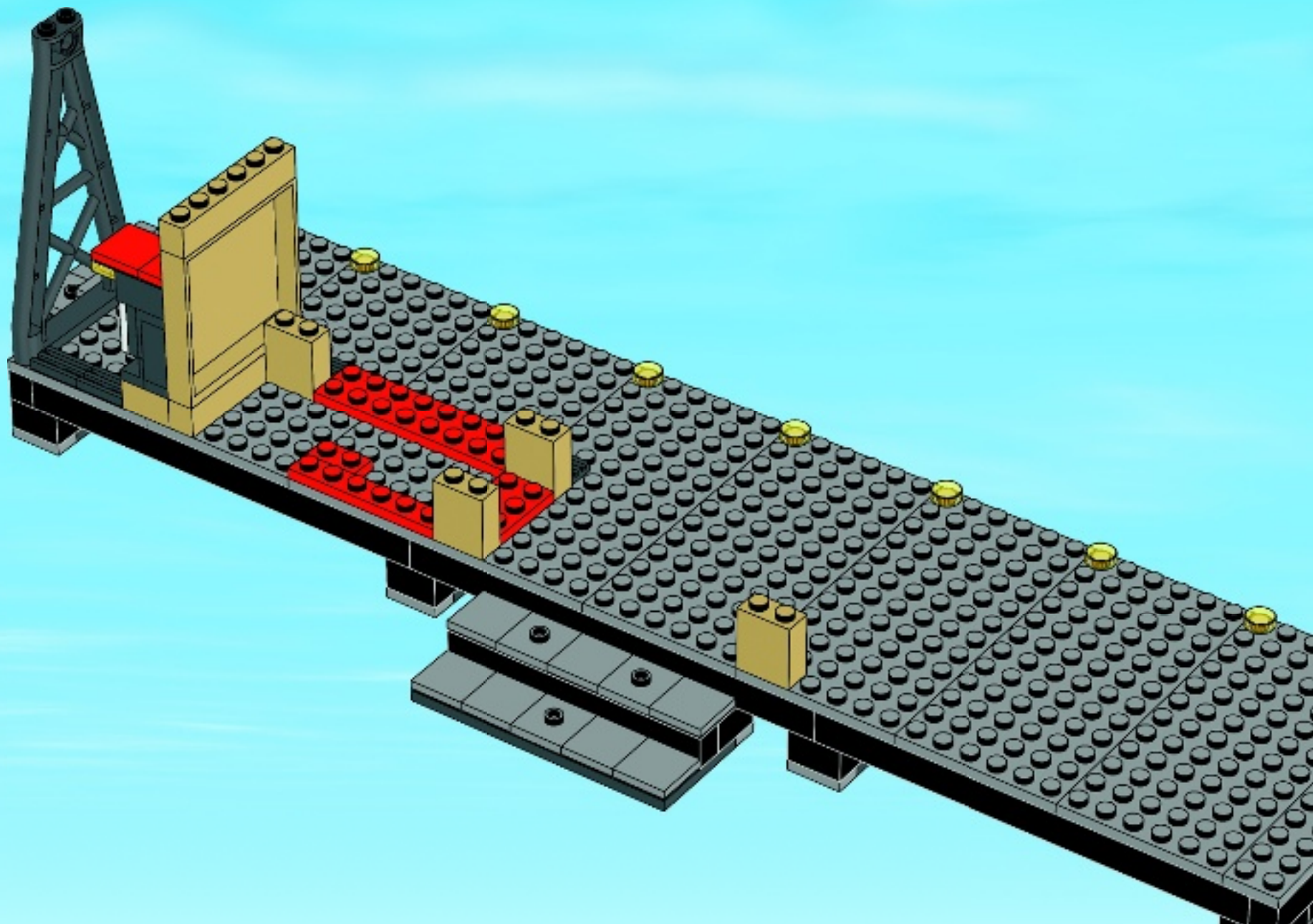

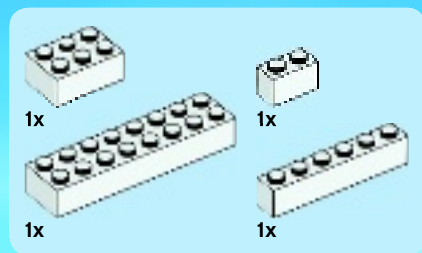

31

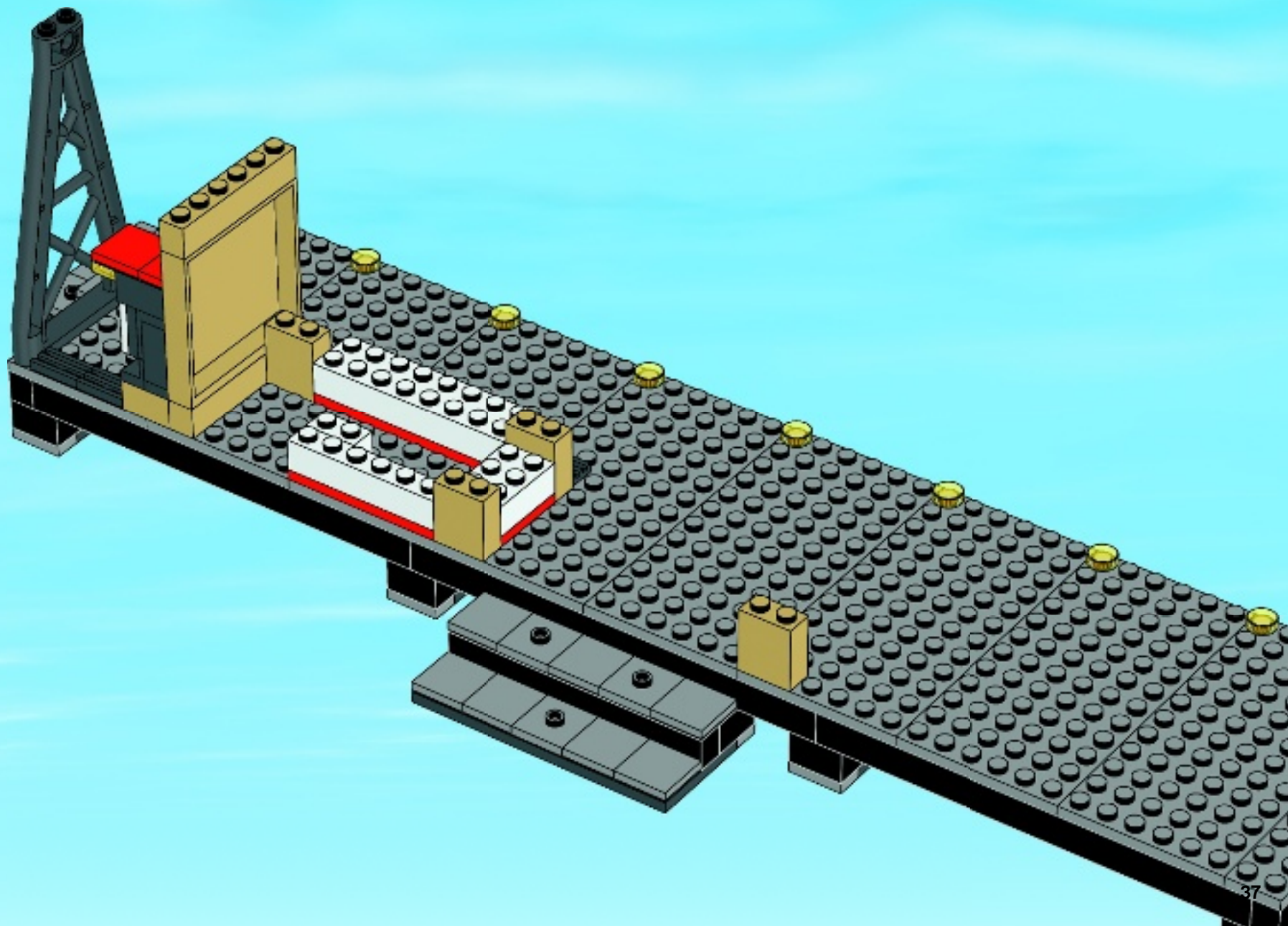



2x



3x

32

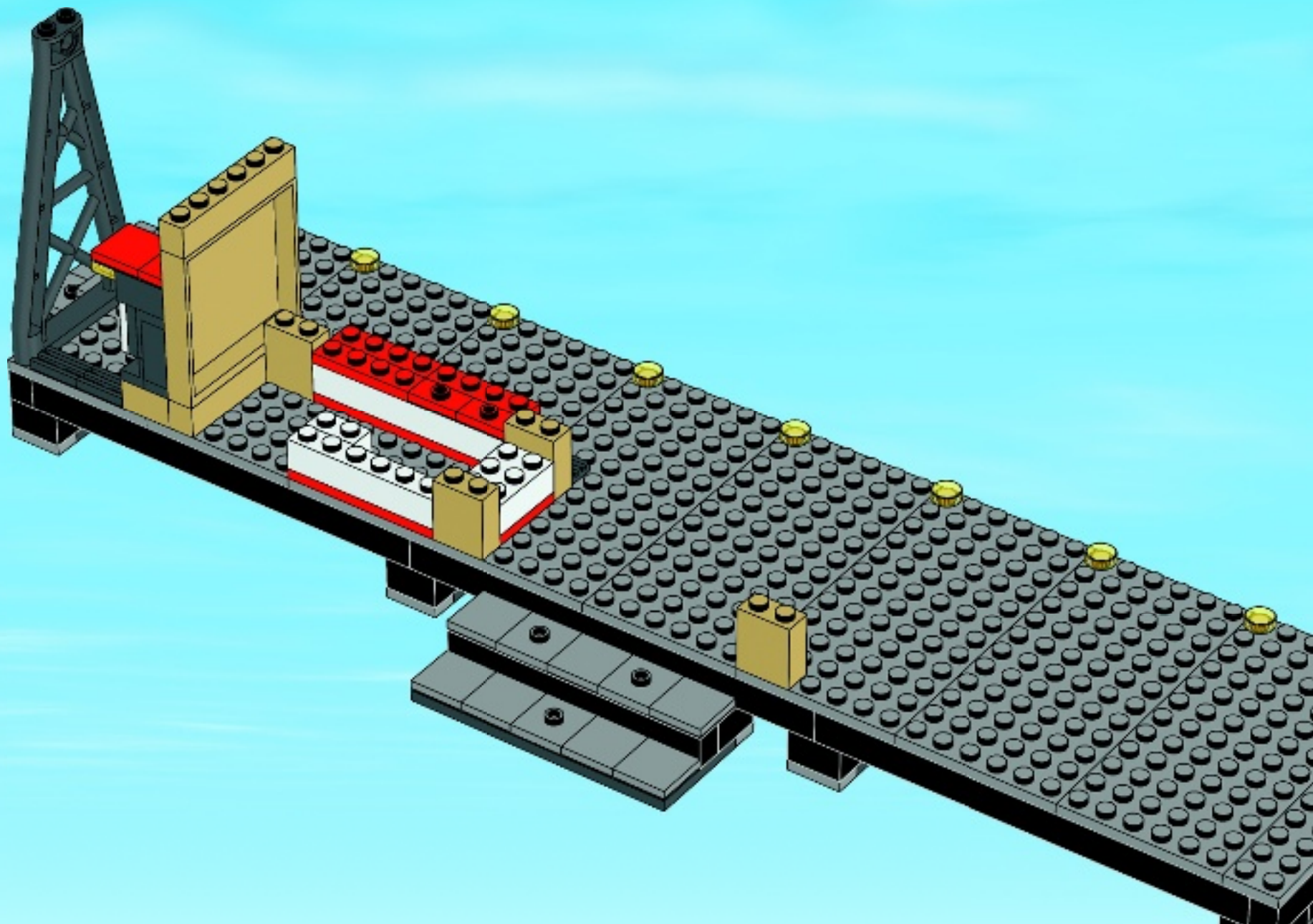



1x



1x



1x

33

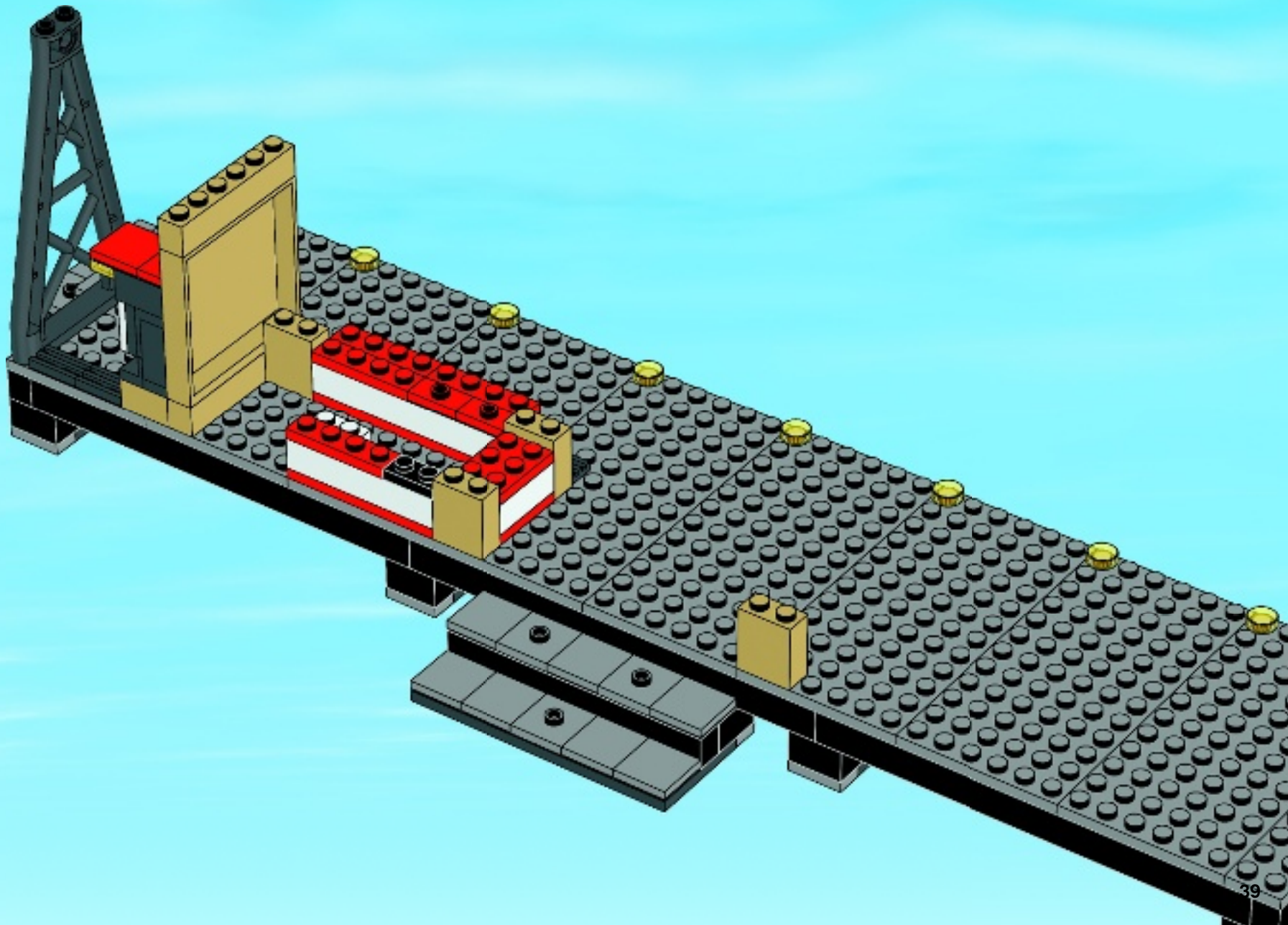



4x

34

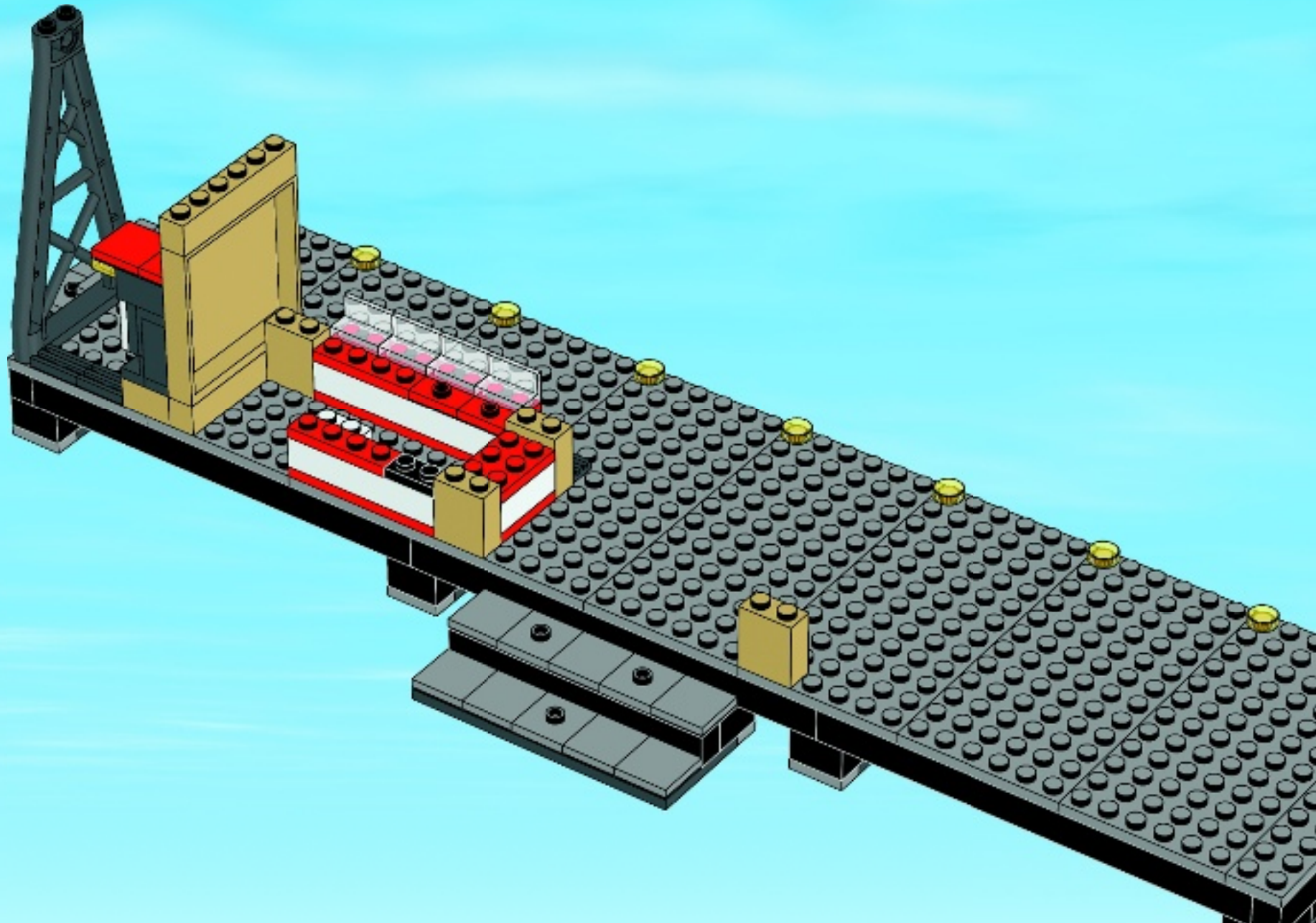

- 1x 
- 1x 
- 1x 
- 1x 

35

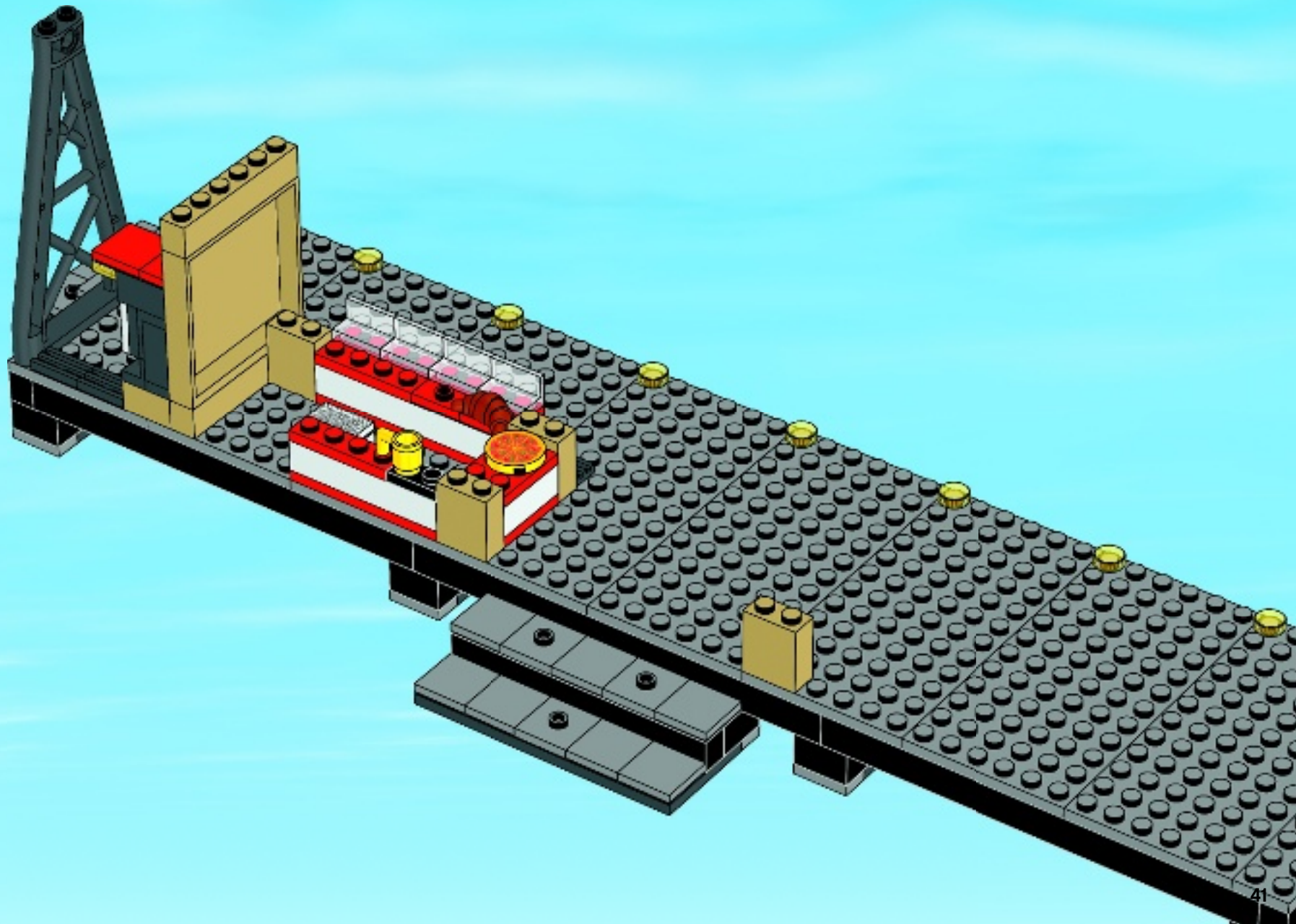



1x



1x



2x

36

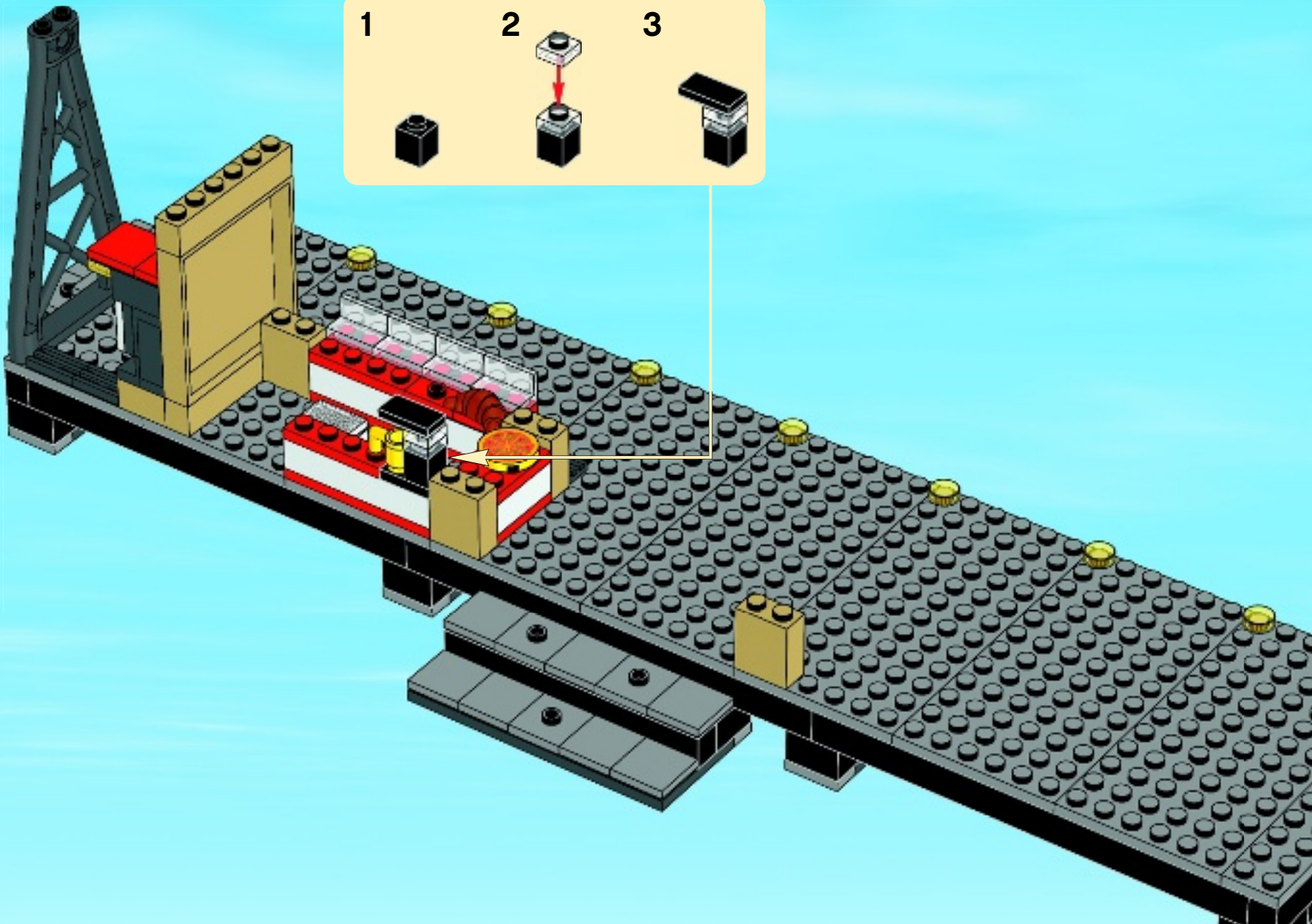
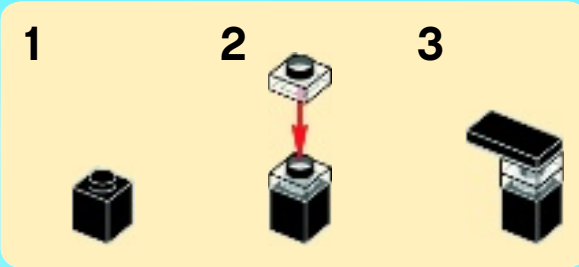



2x



2x



2x



2x

37

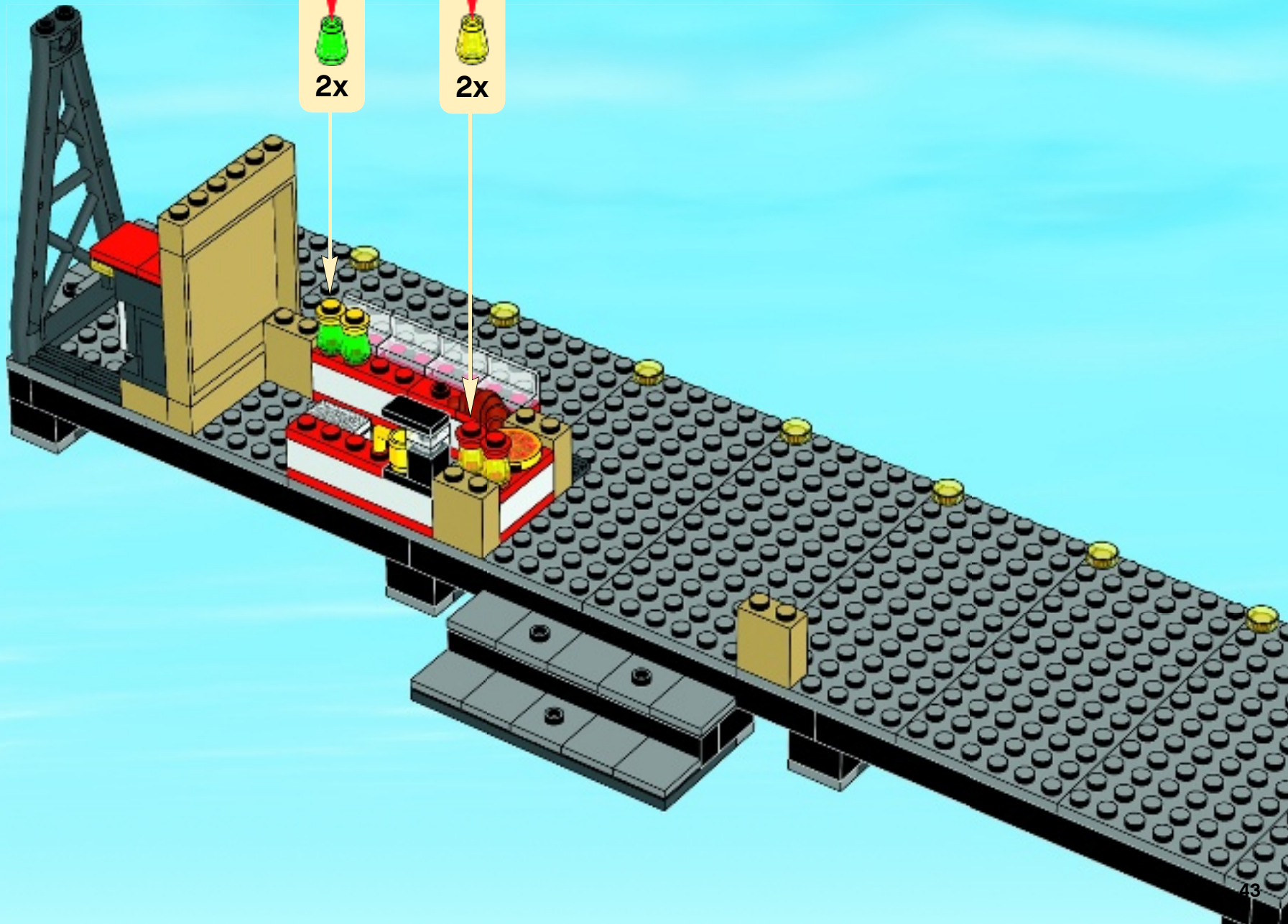



1x



1x

38





3x

39

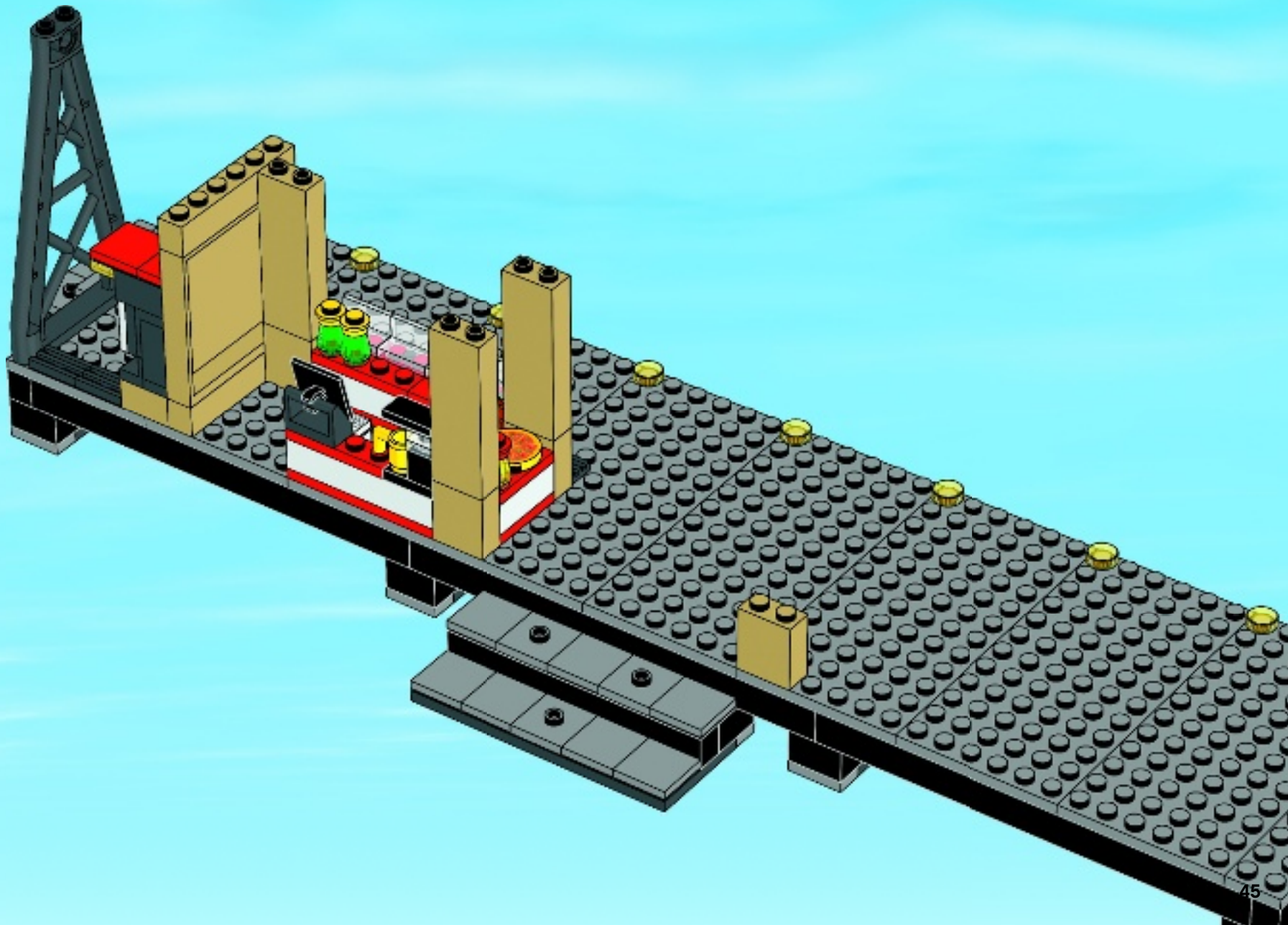

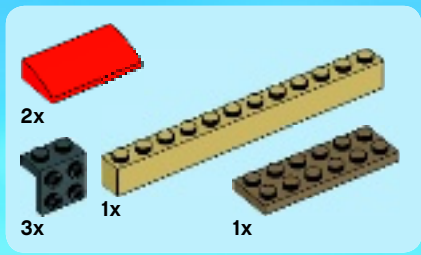

40

1

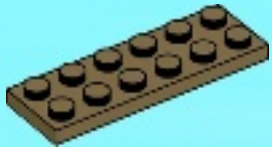

2

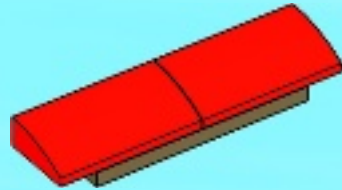

3

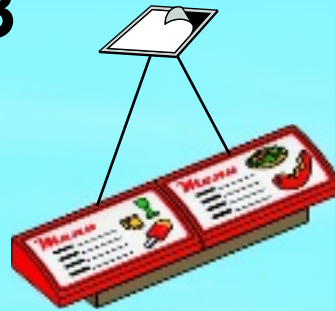

4

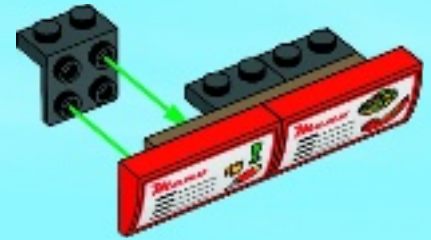

5

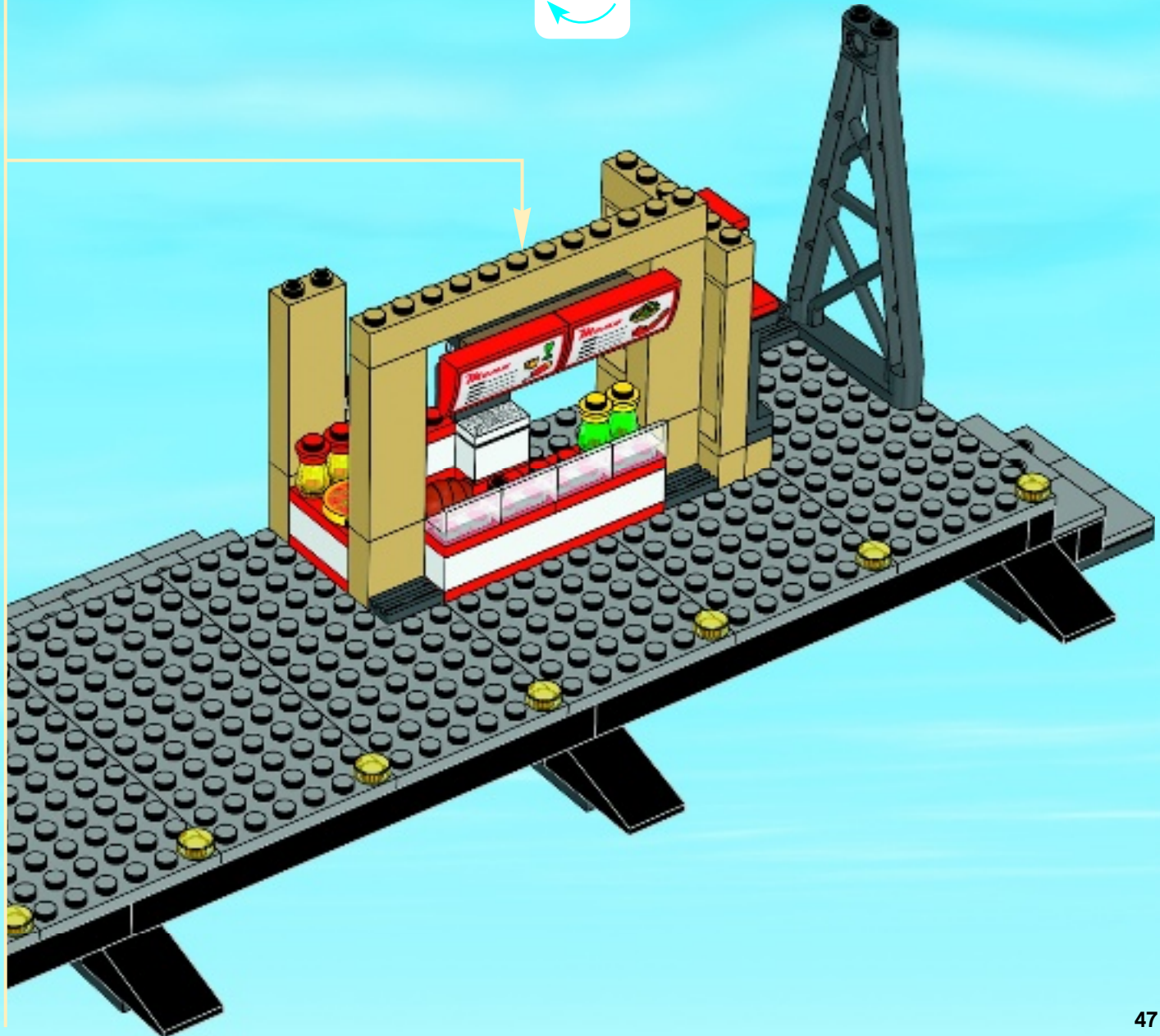



41

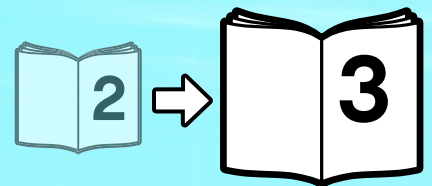
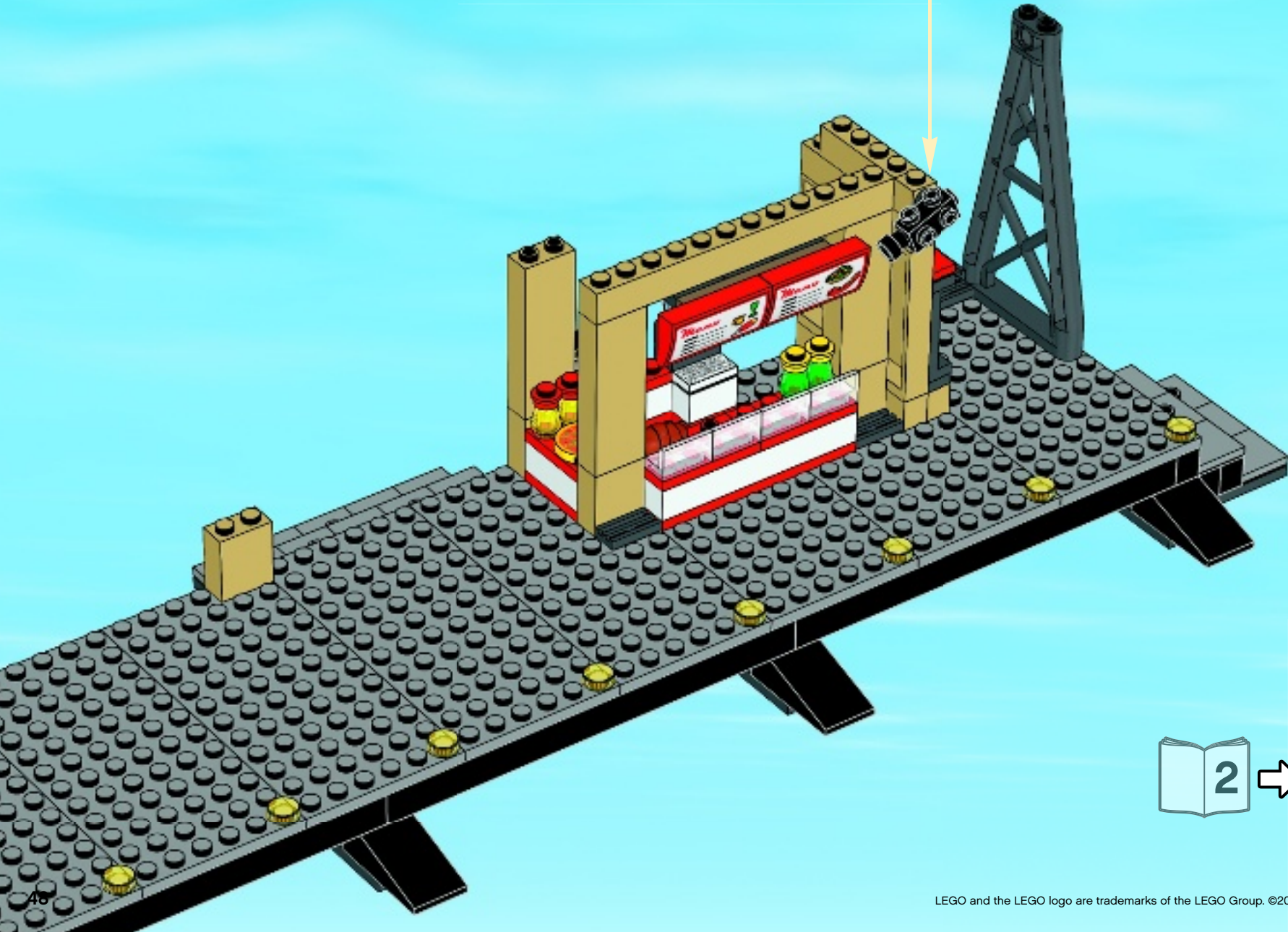
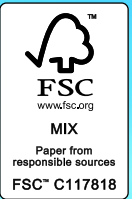
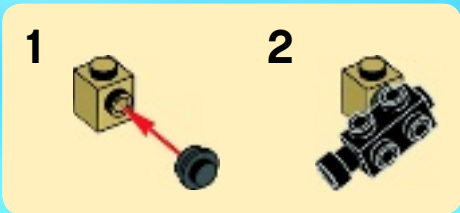



CITY

60050



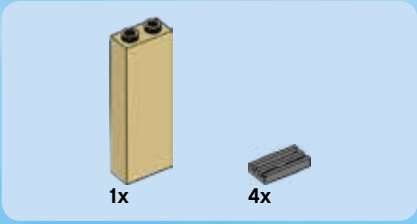
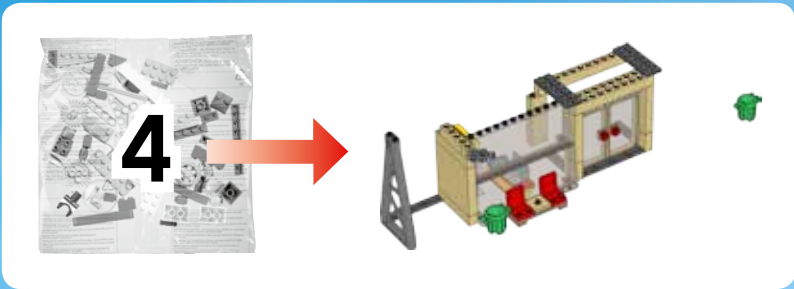

42

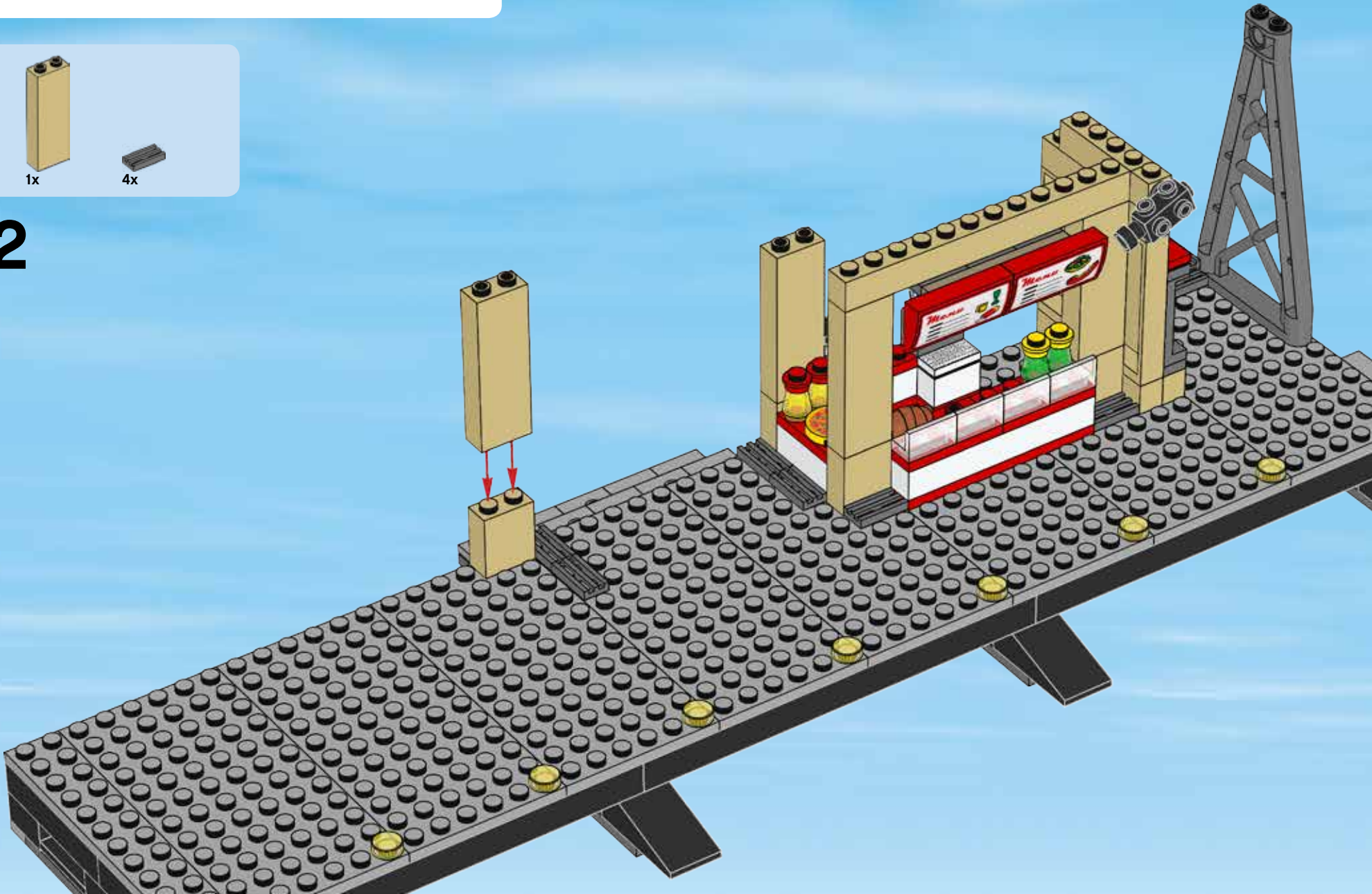



2x



4x

43

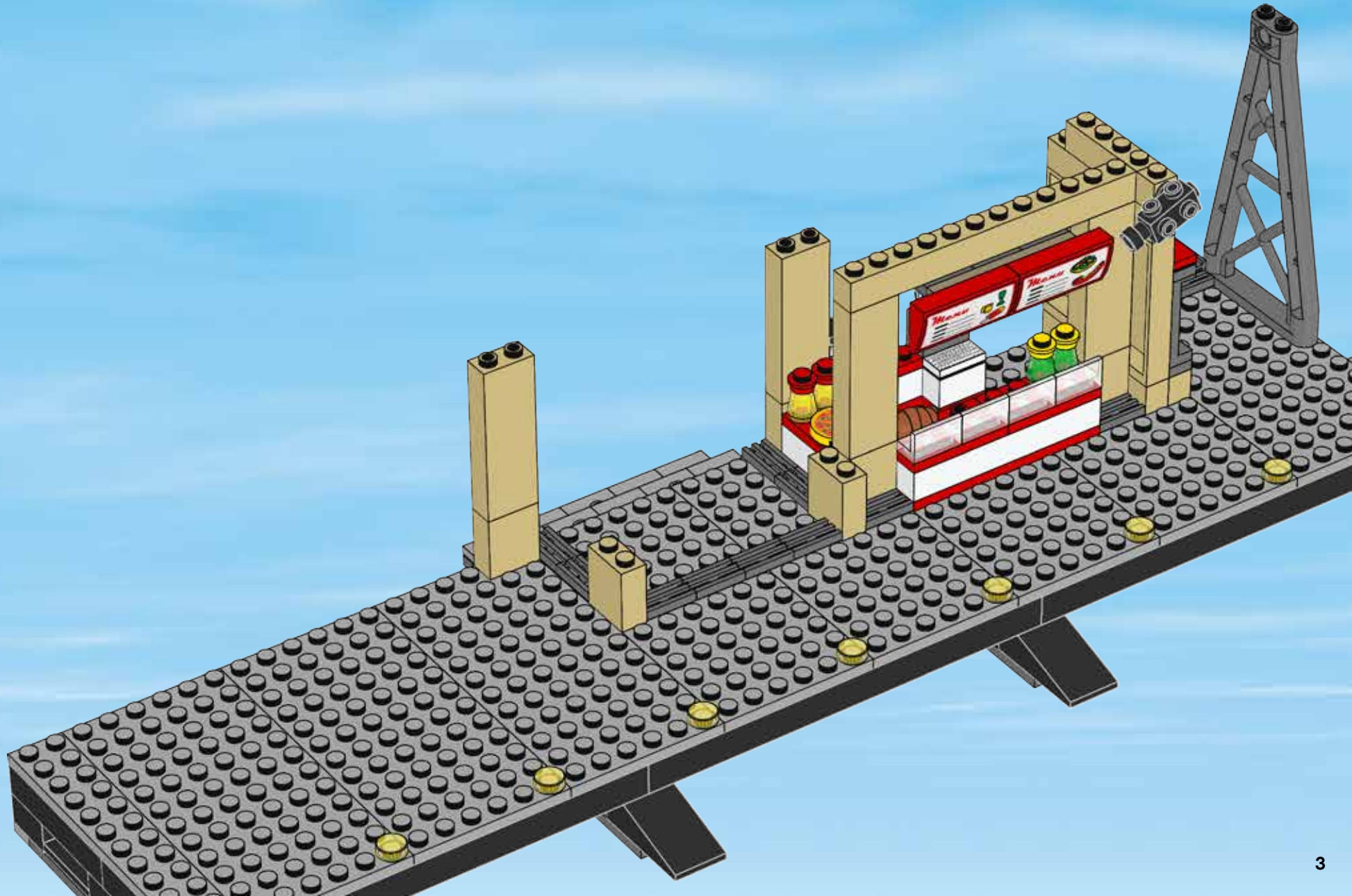

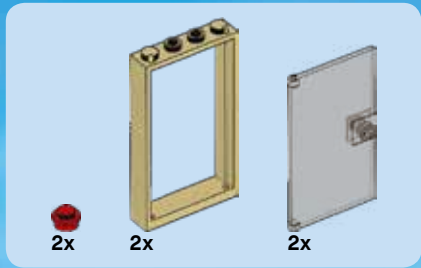

44

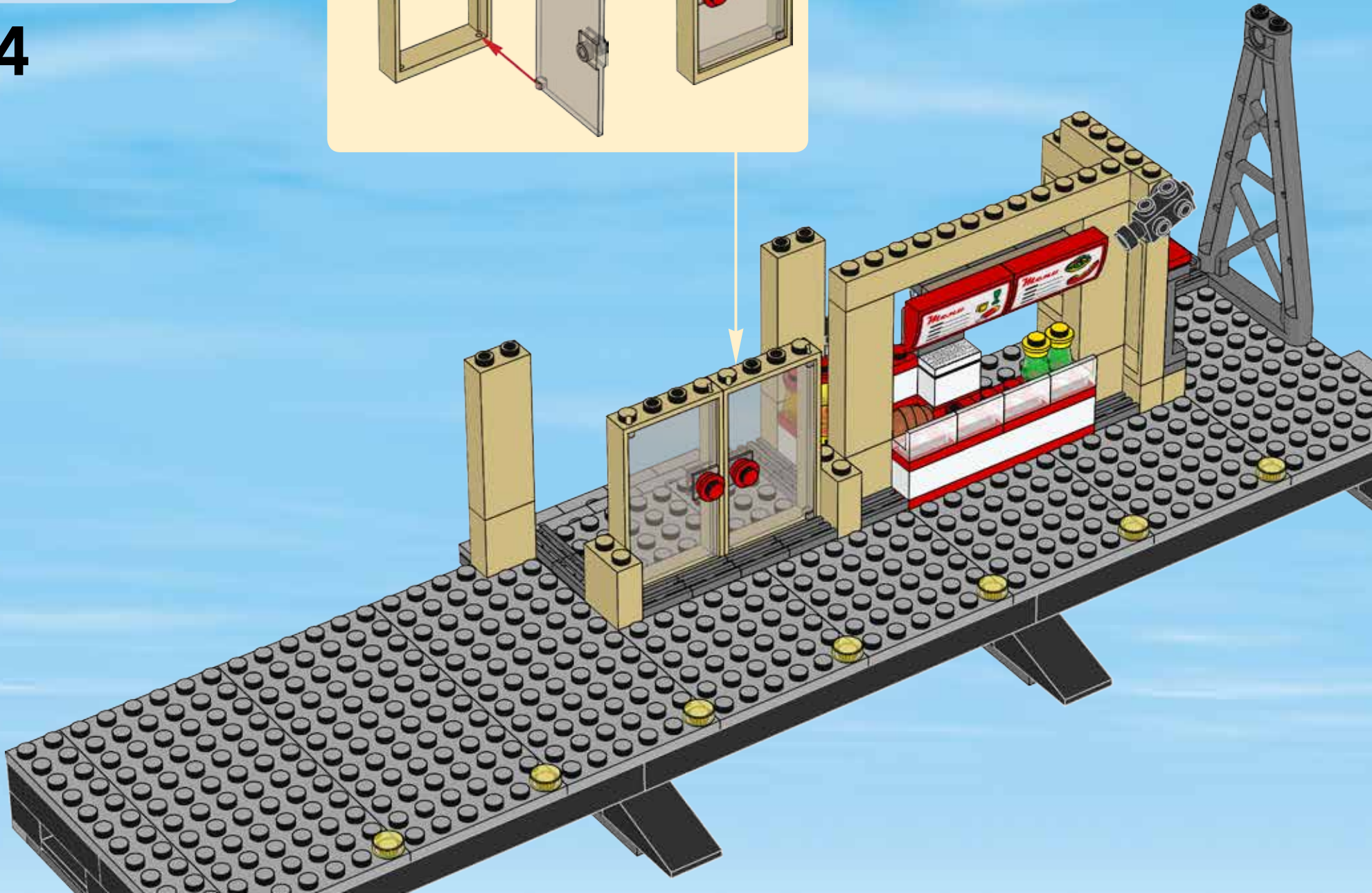
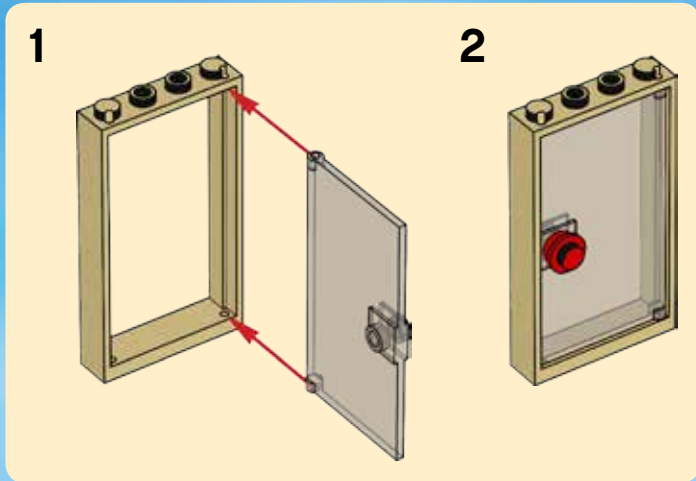

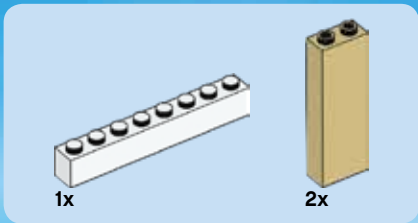

45

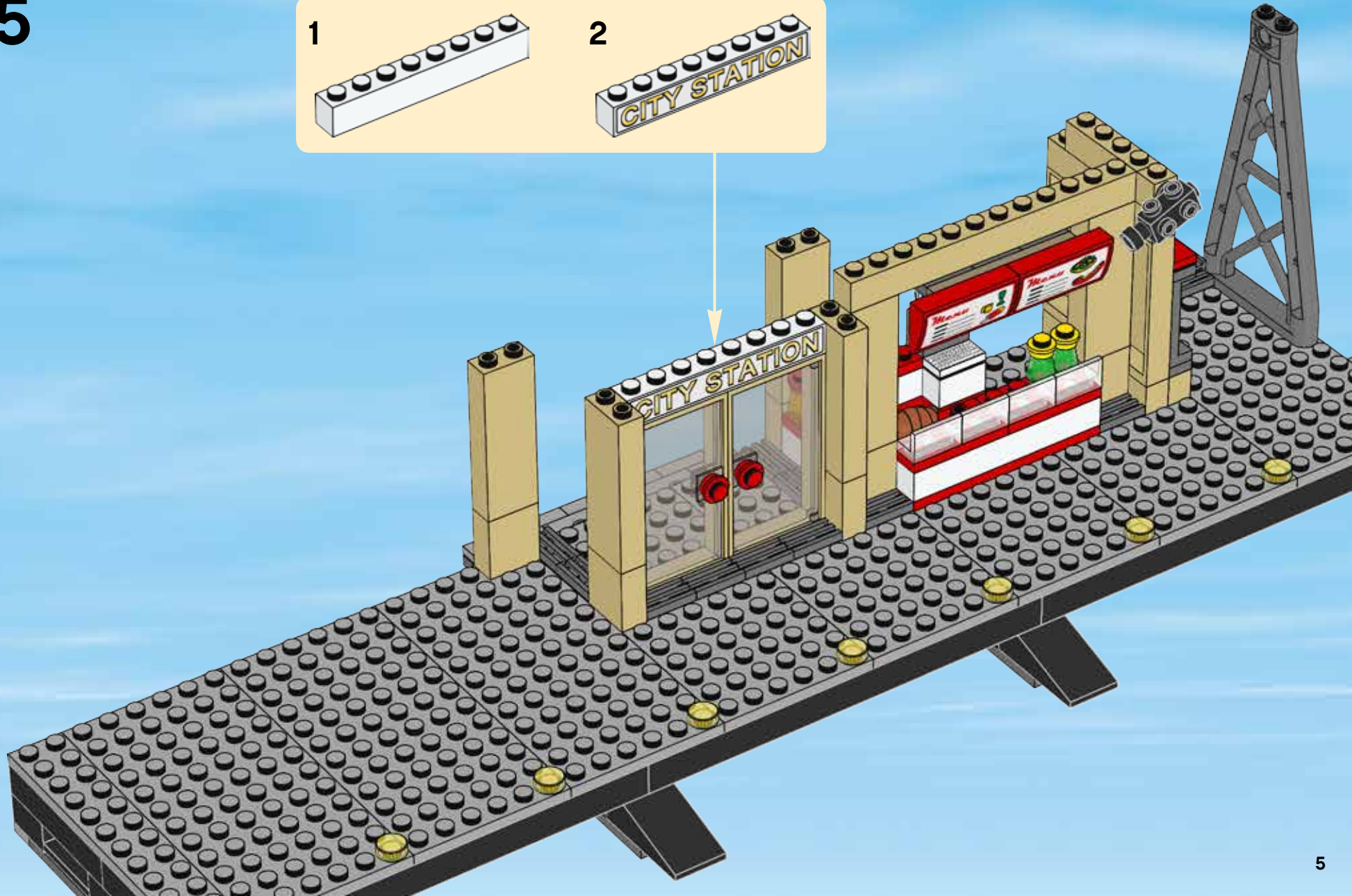
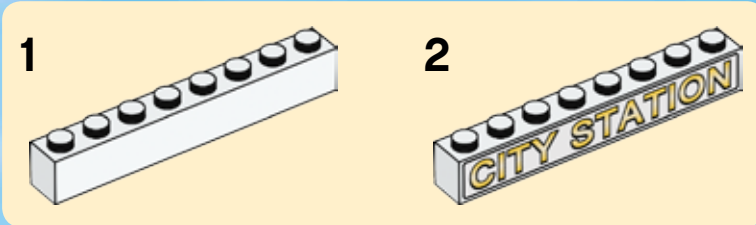

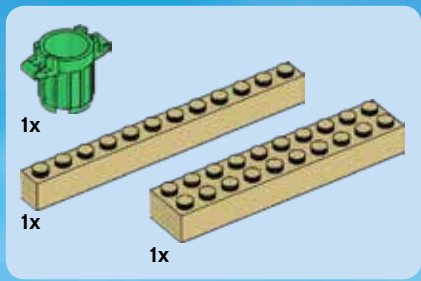

46

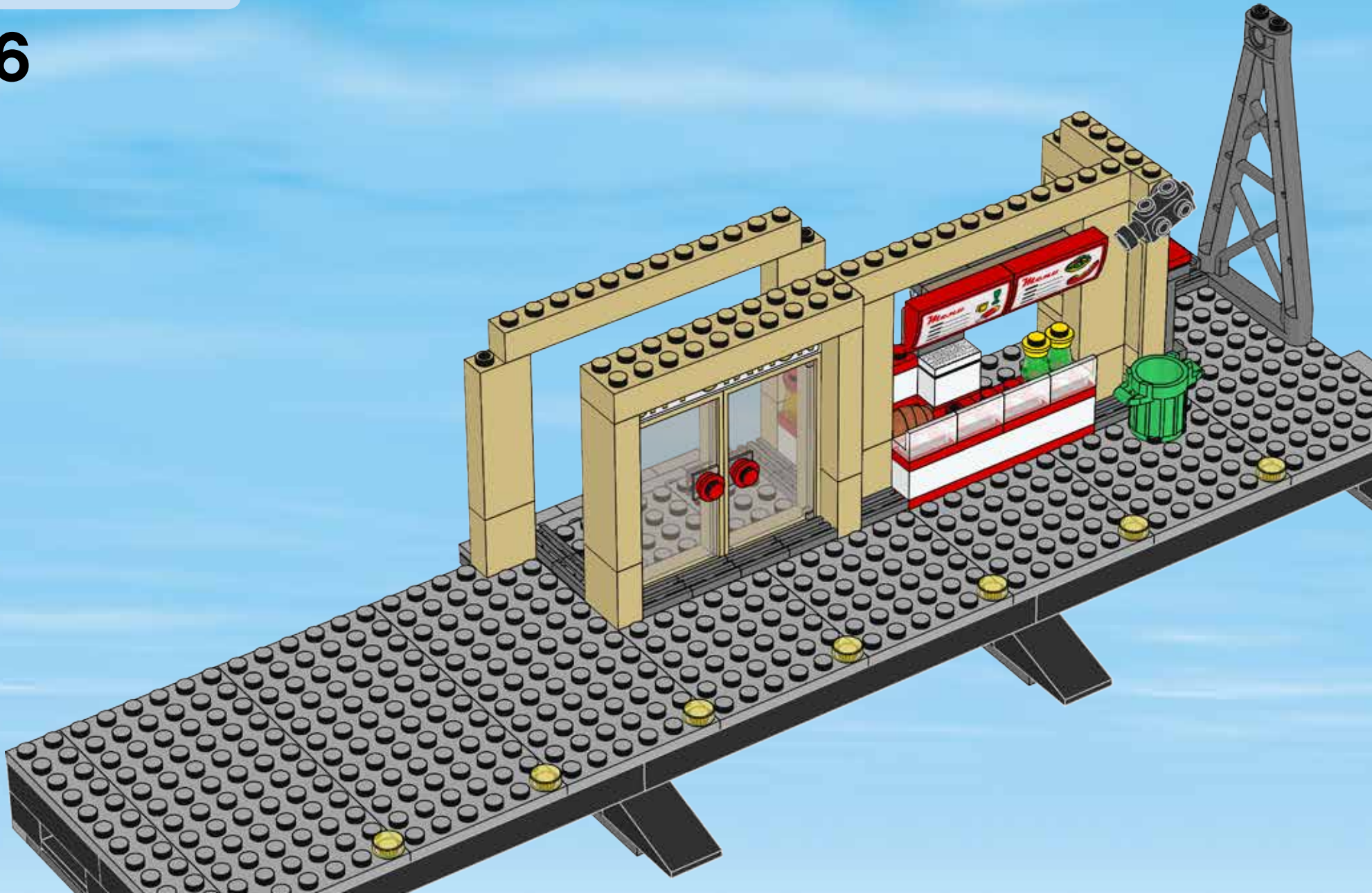

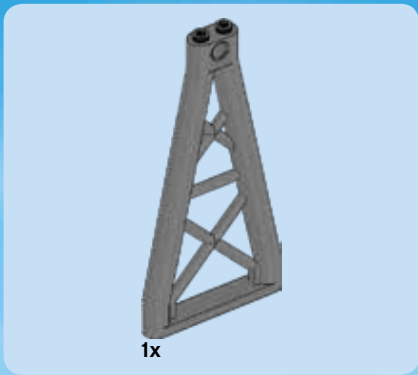

47

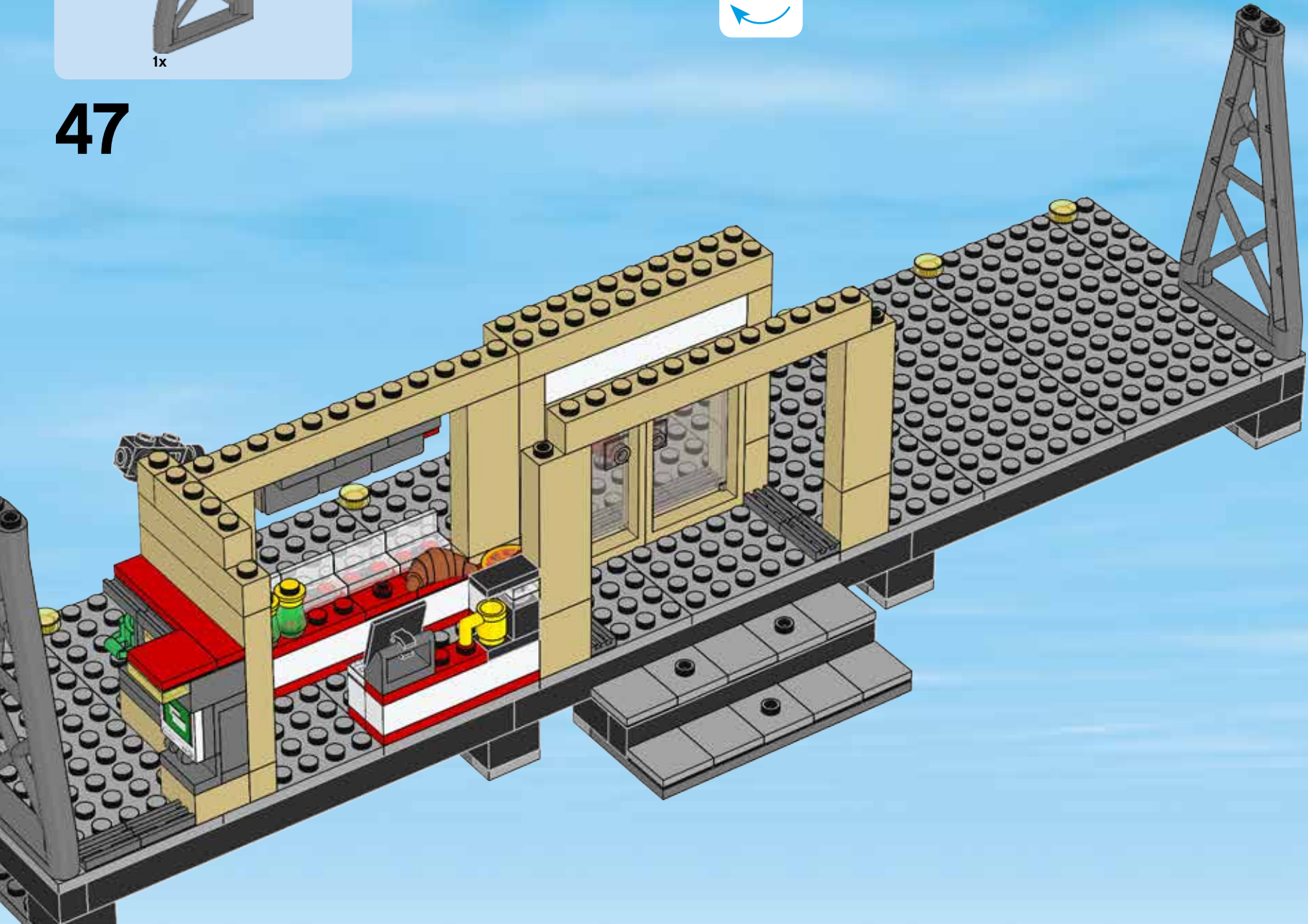



3x

48

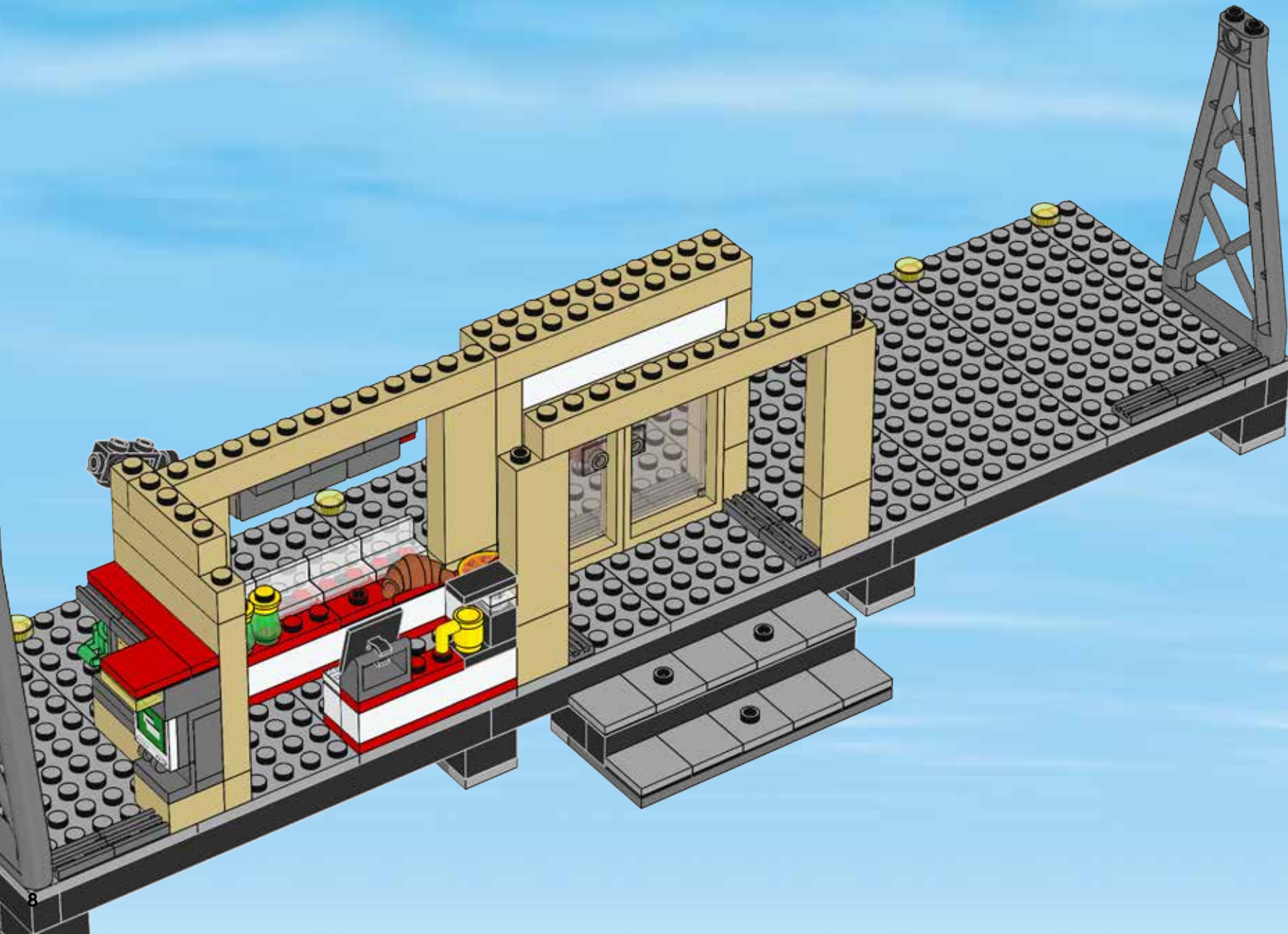

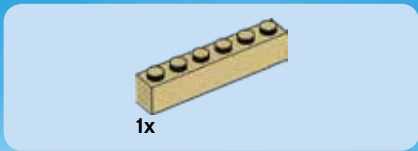

49

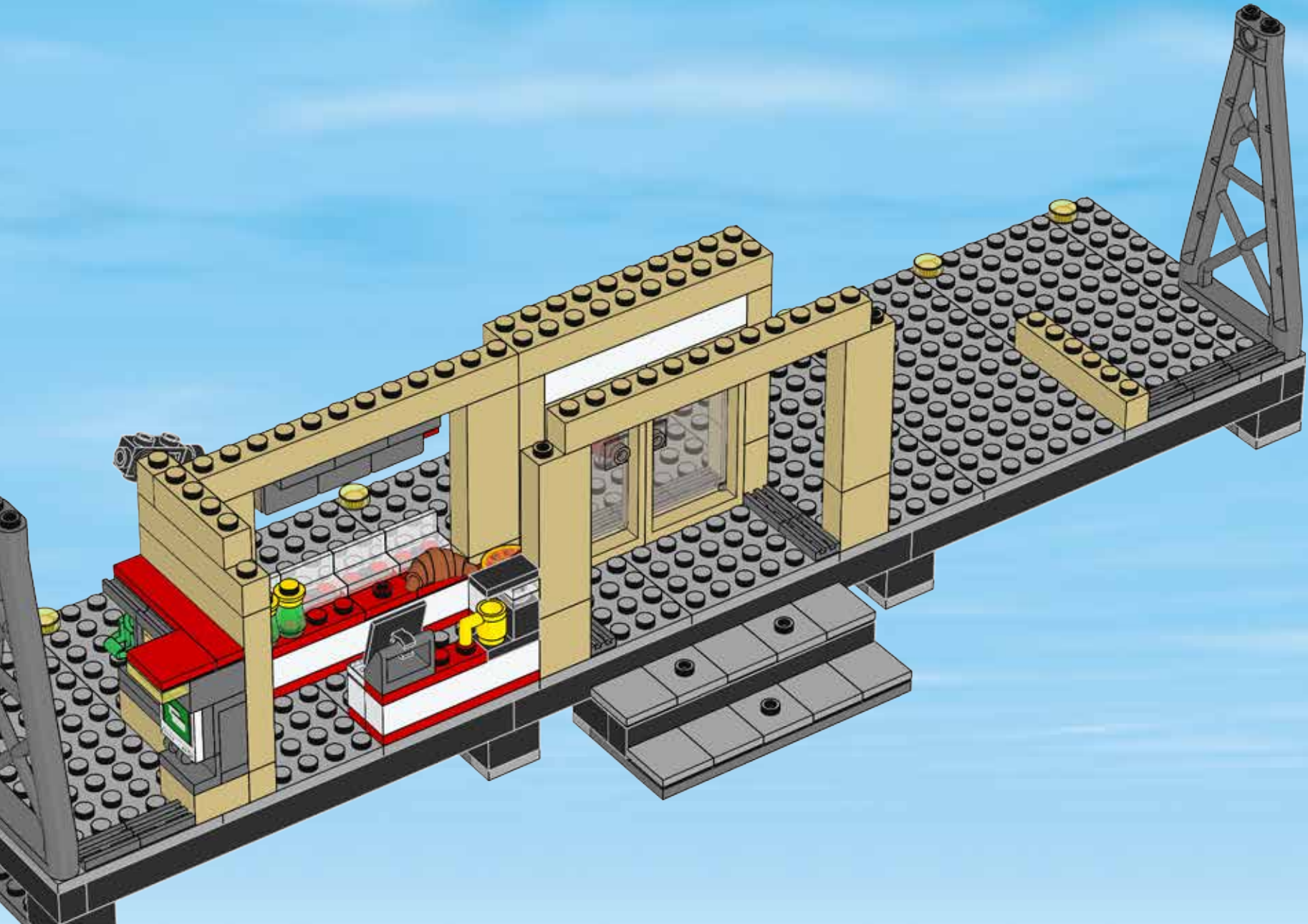



1x



1x

50

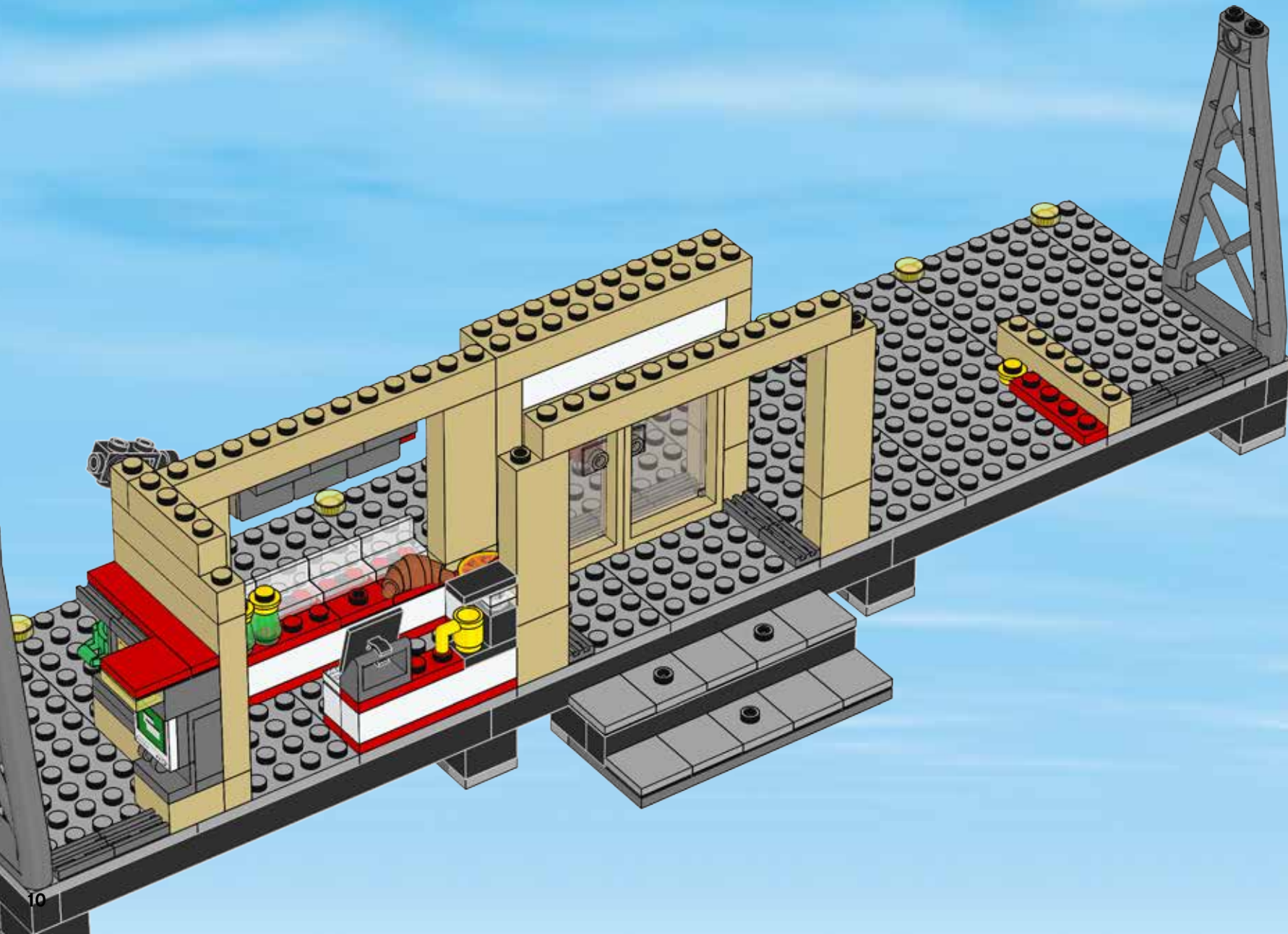

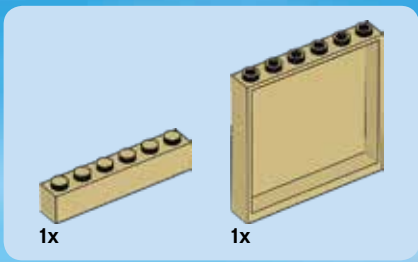

51

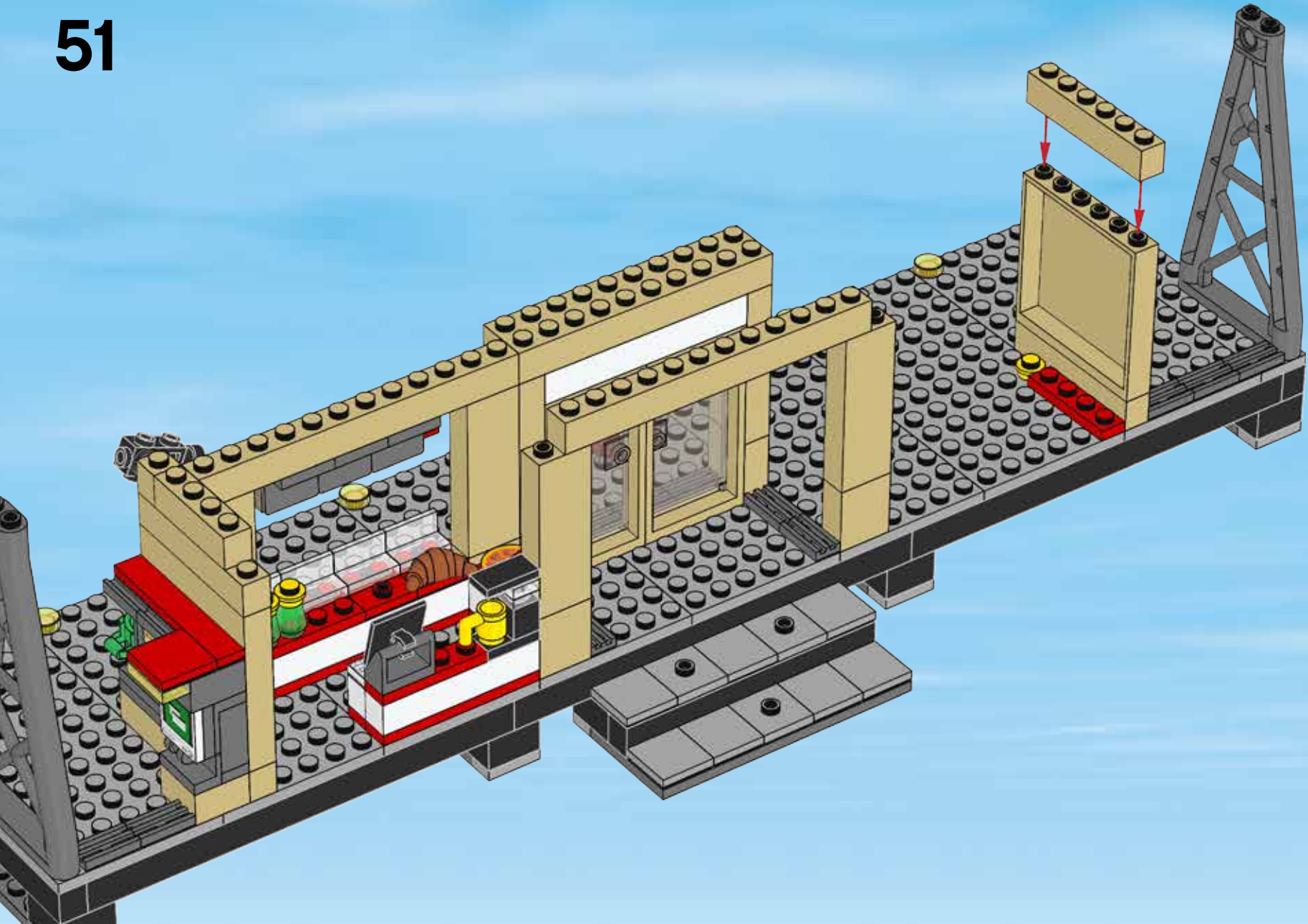

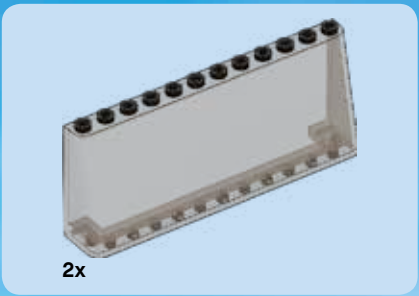

52

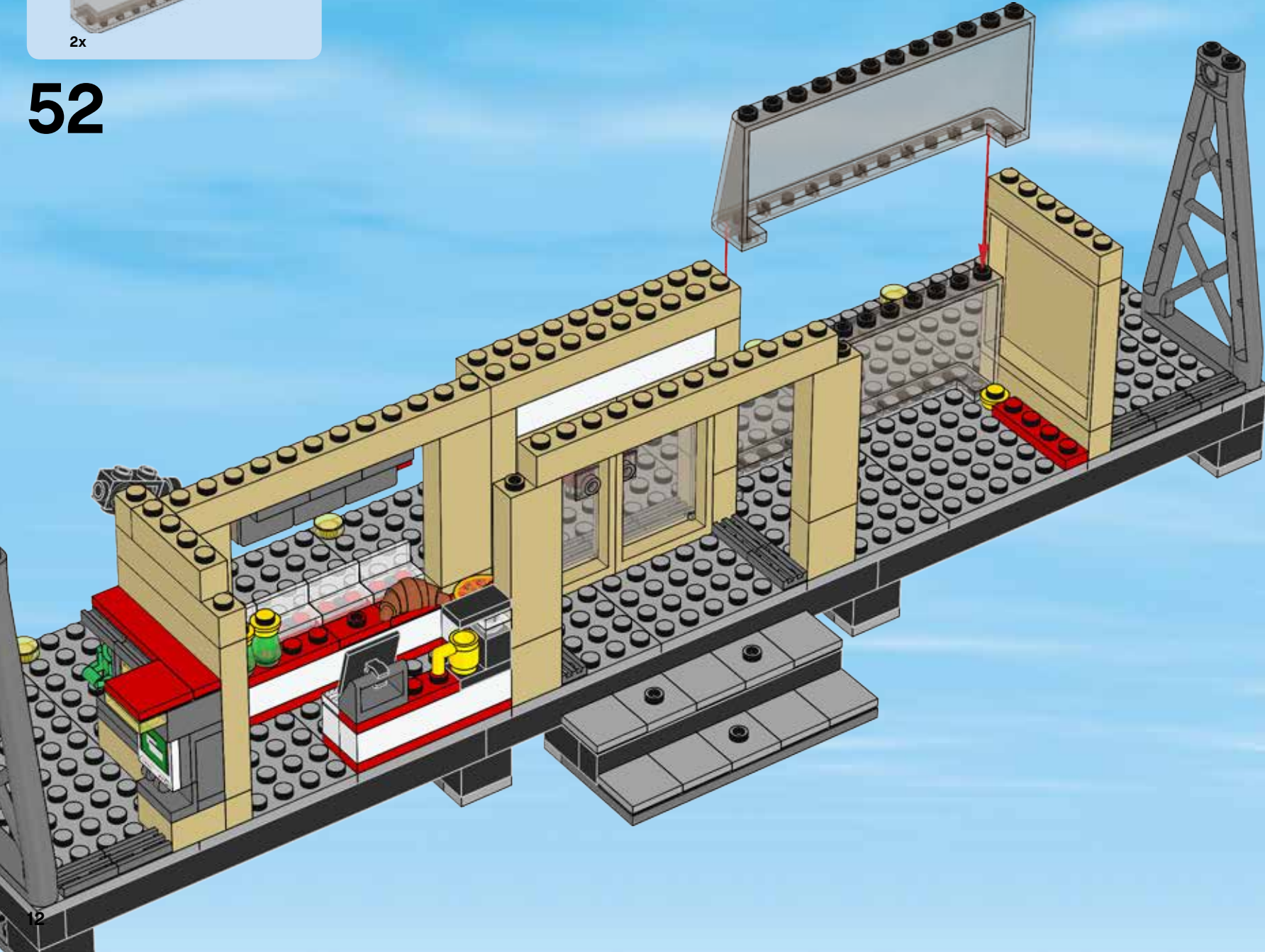

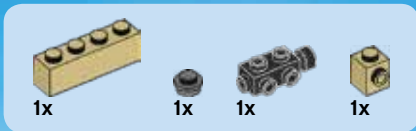

53

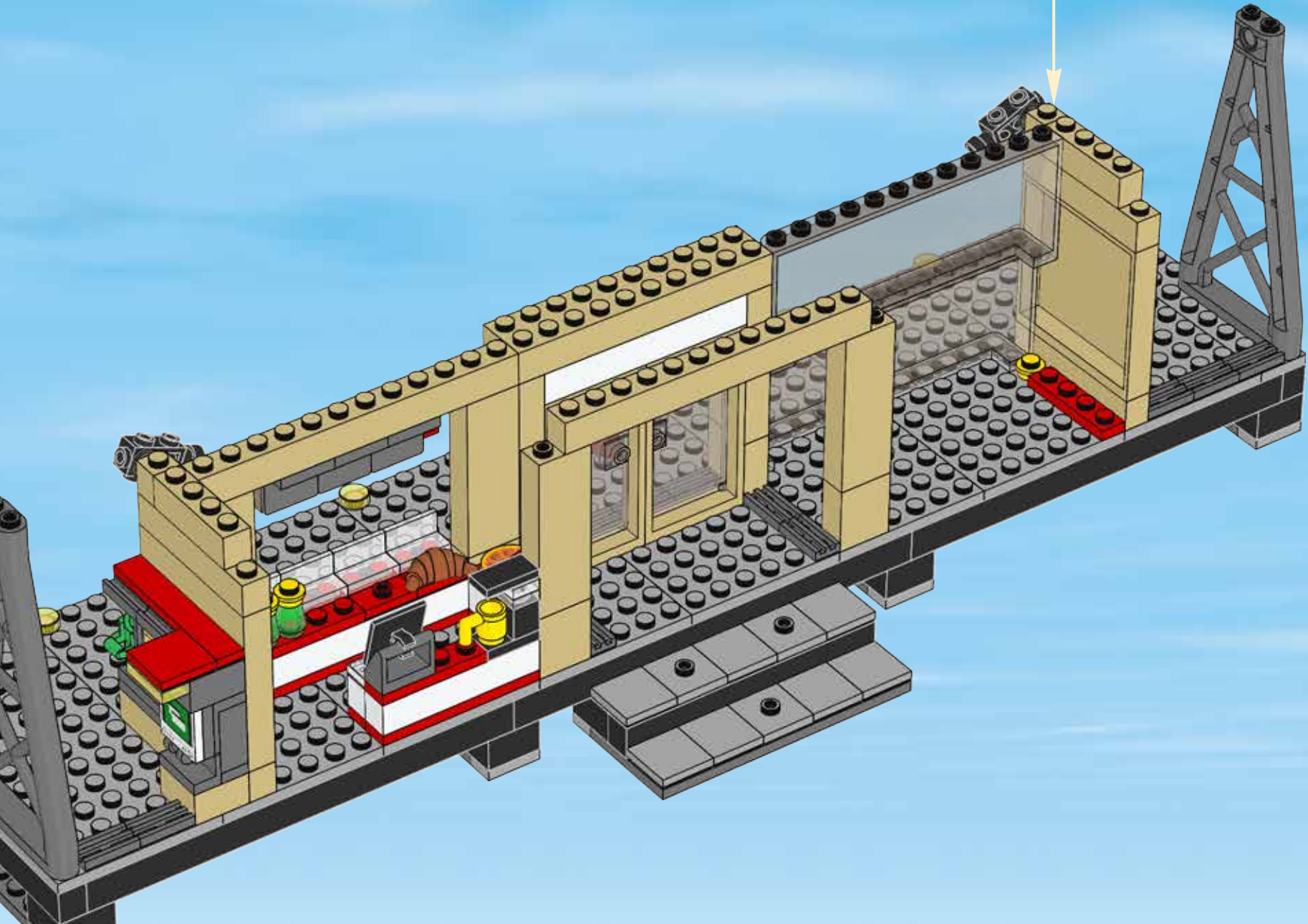
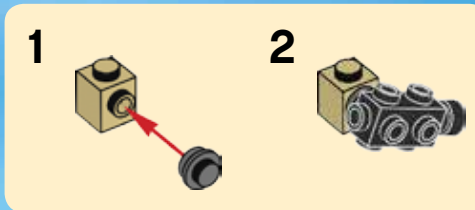

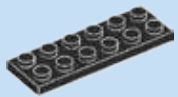

2x

54

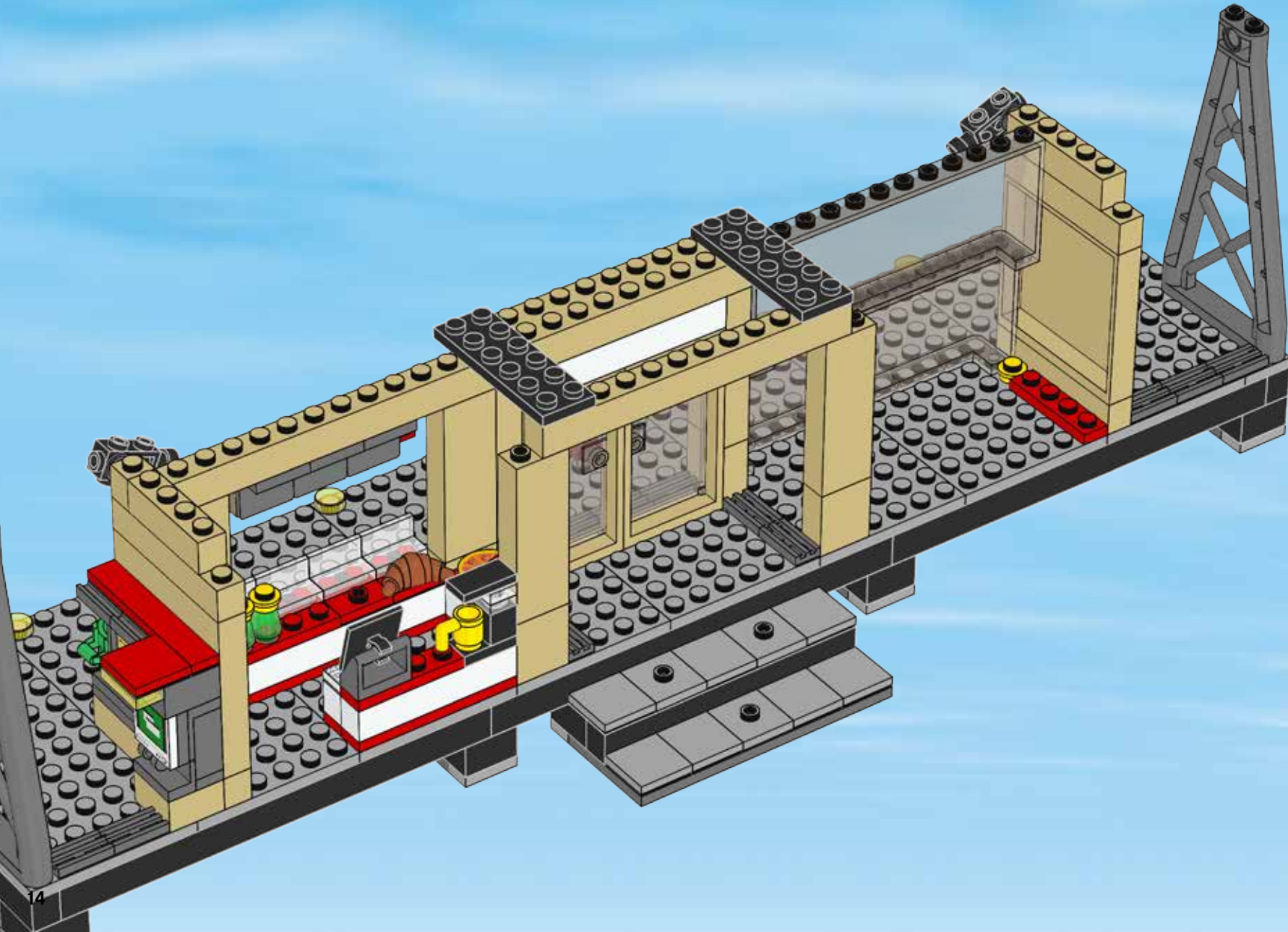

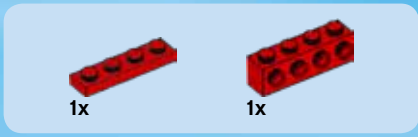

1

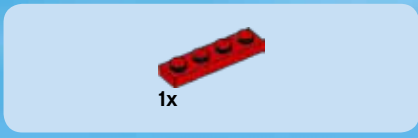
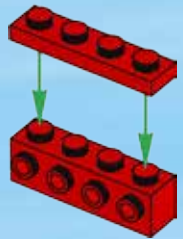

2

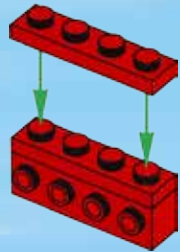

3

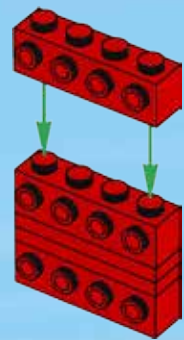



4

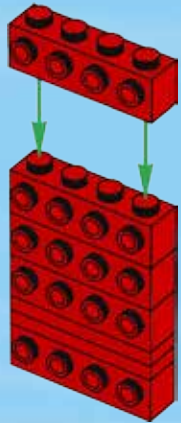

5



6

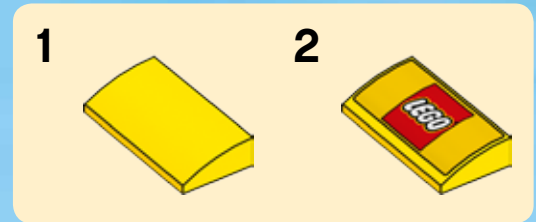



7

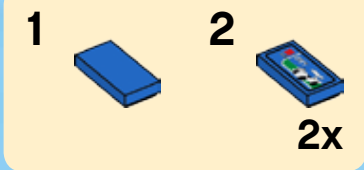

8



9

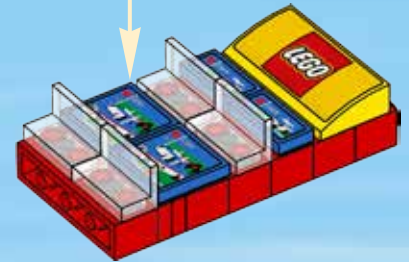
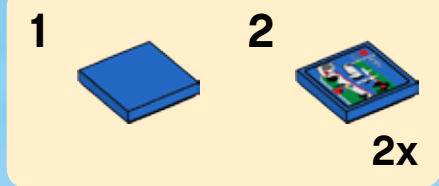

55

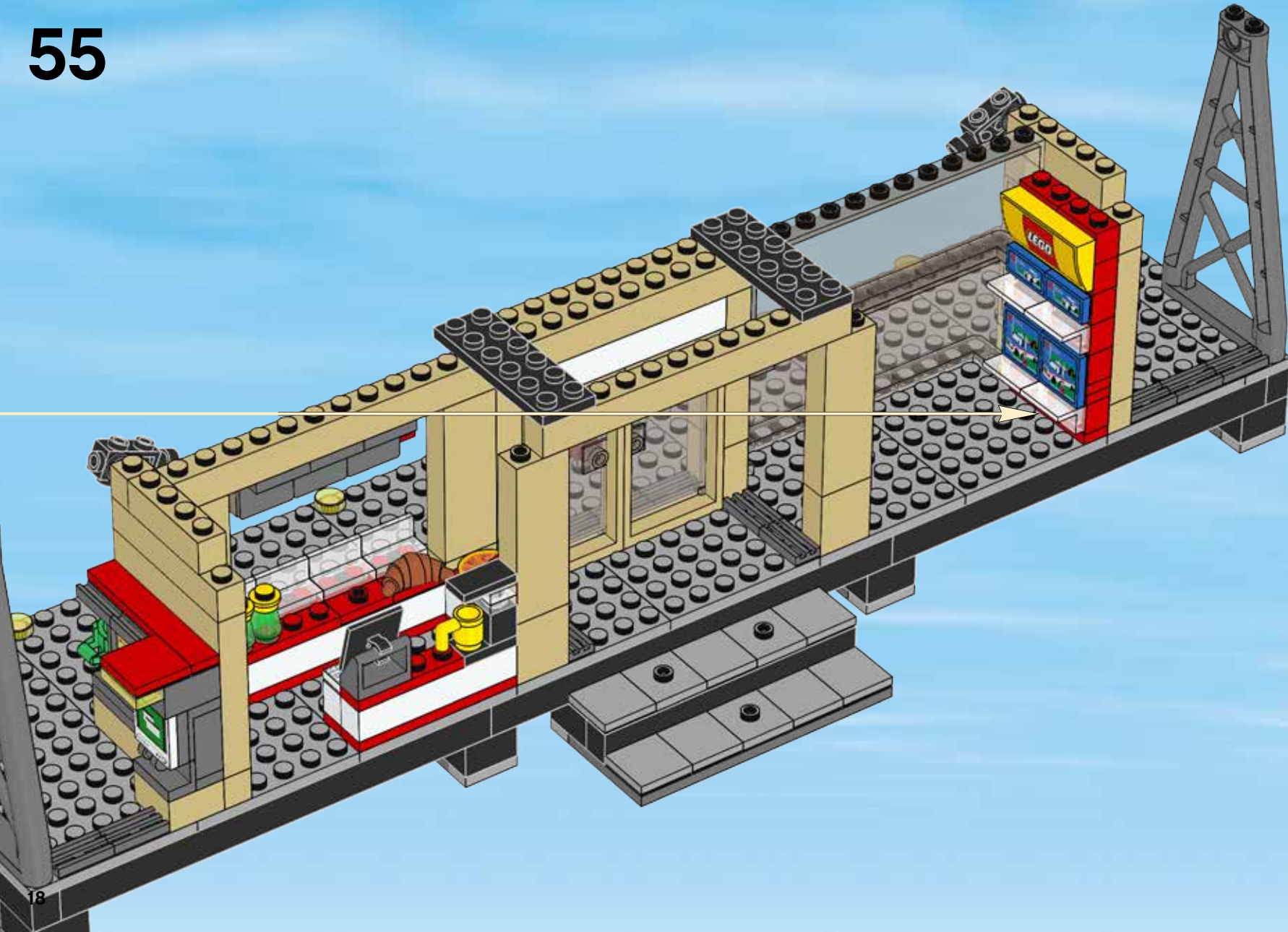

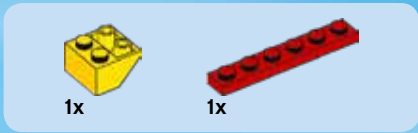

1

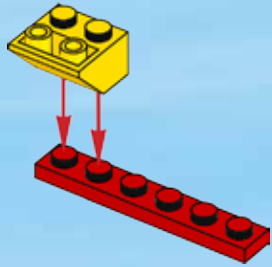

2

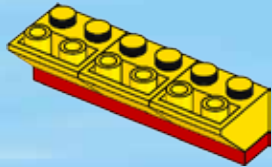

3

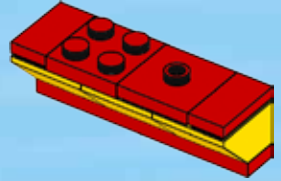



1x



1x

4

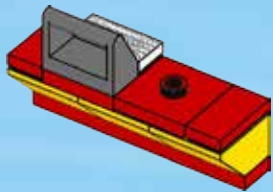

1x

5

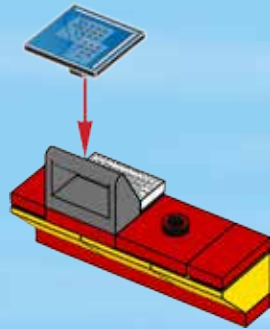

1x

6

1

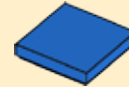

2

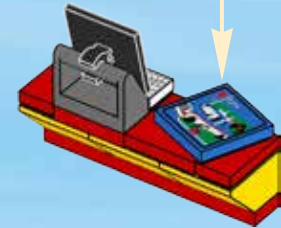

56

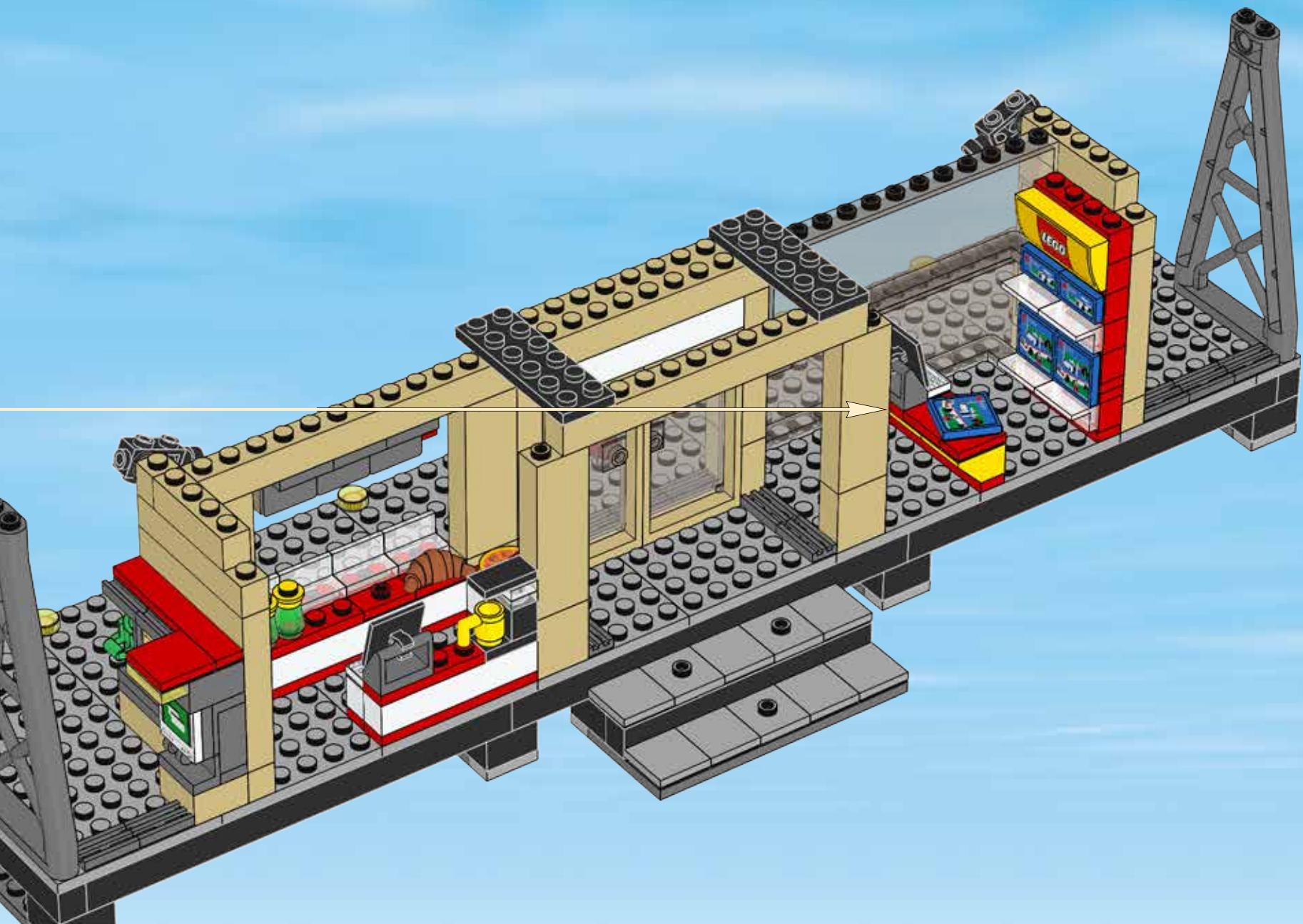

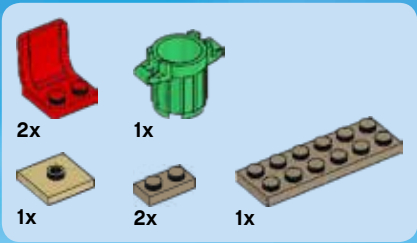

57

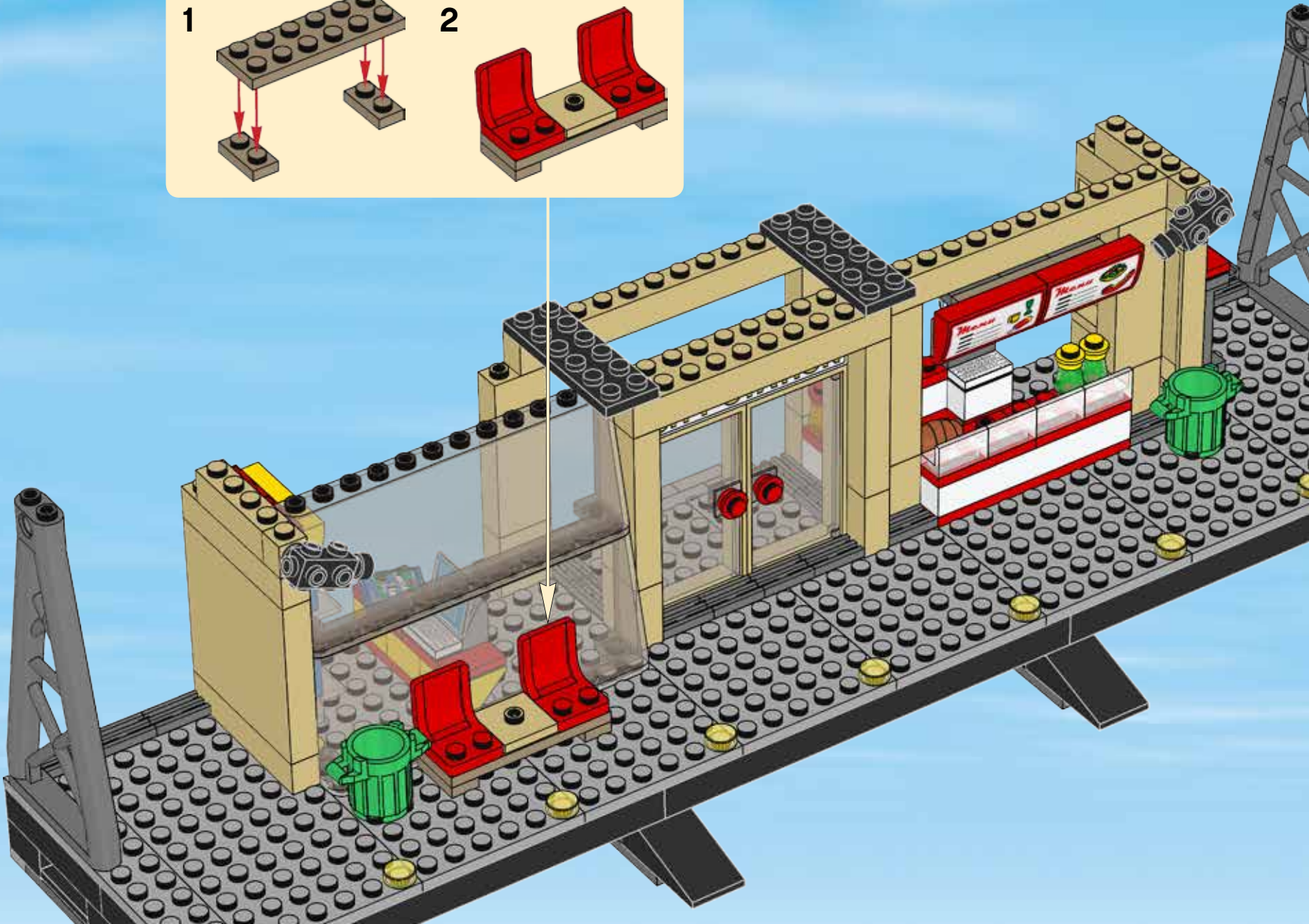
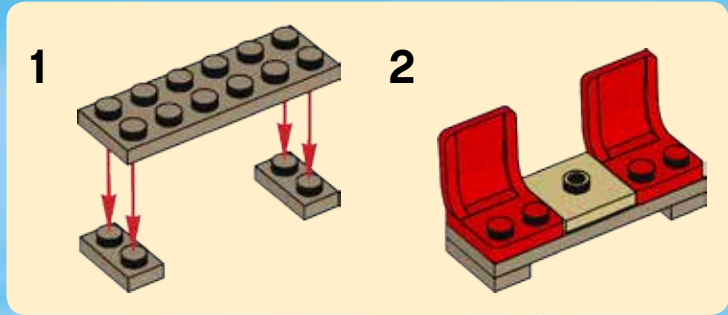

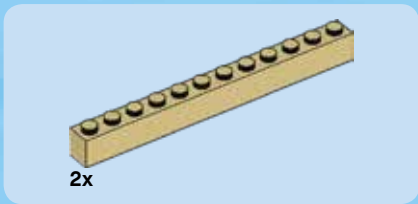
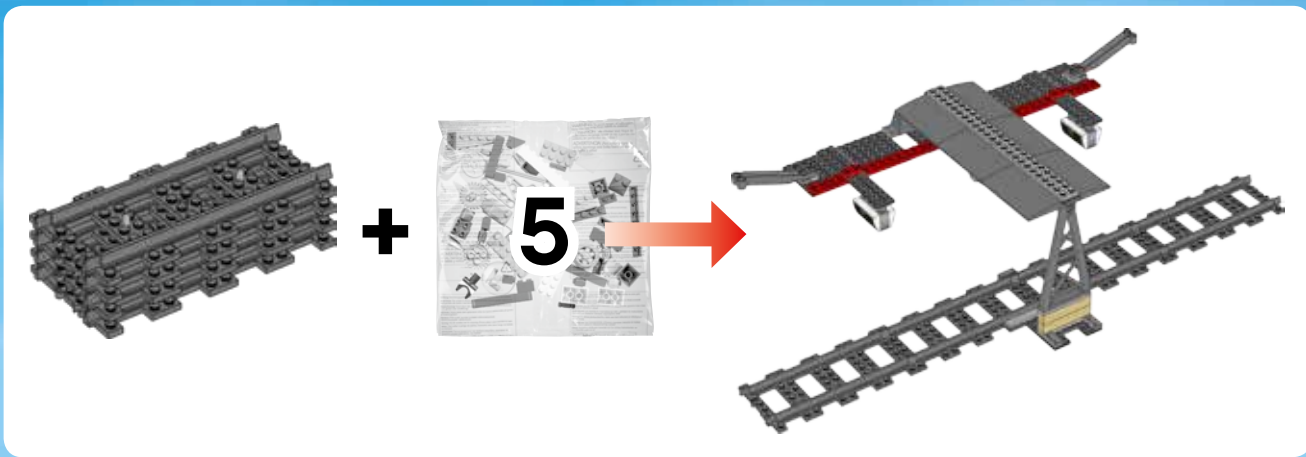

58

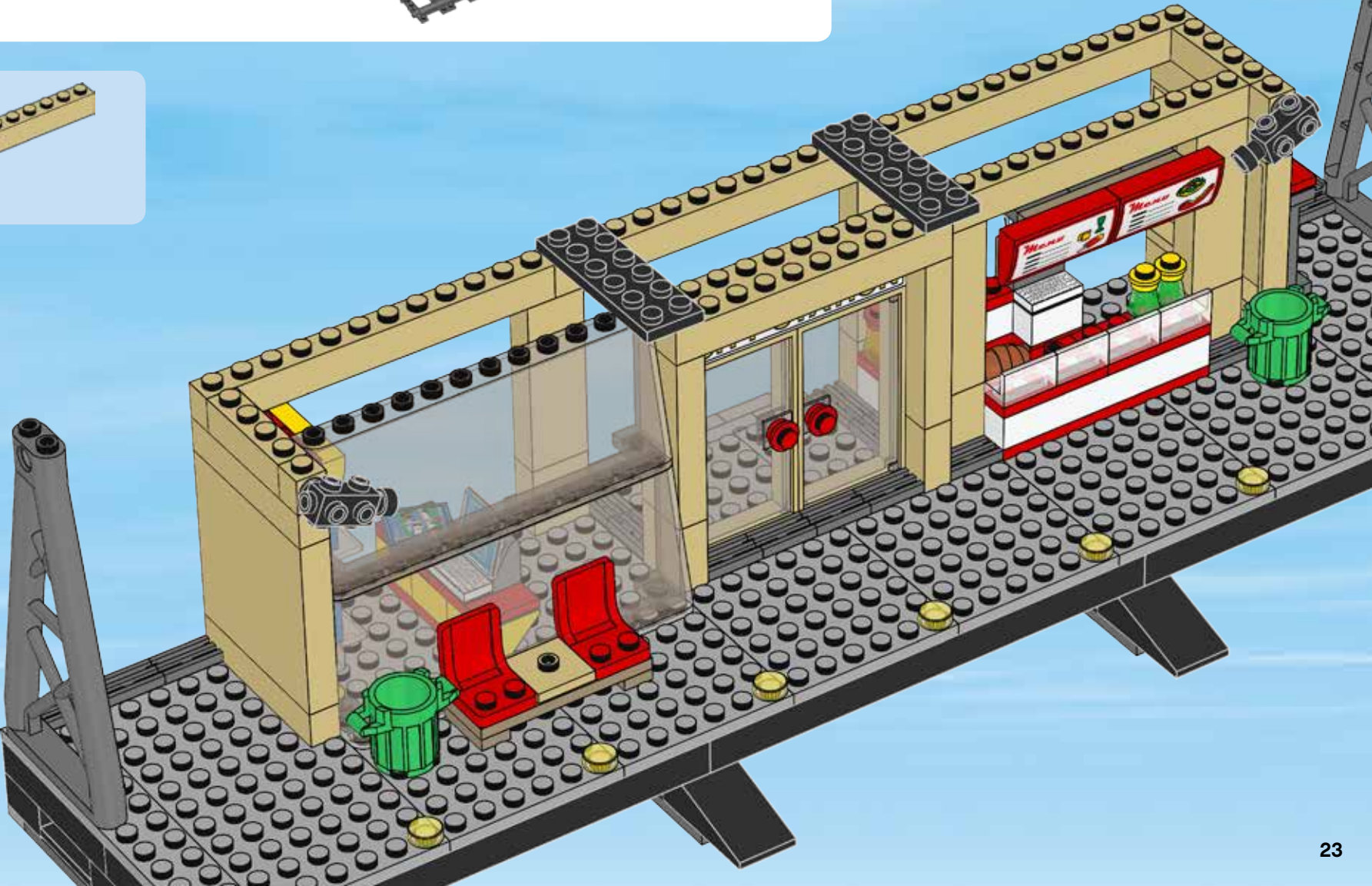



2x

59

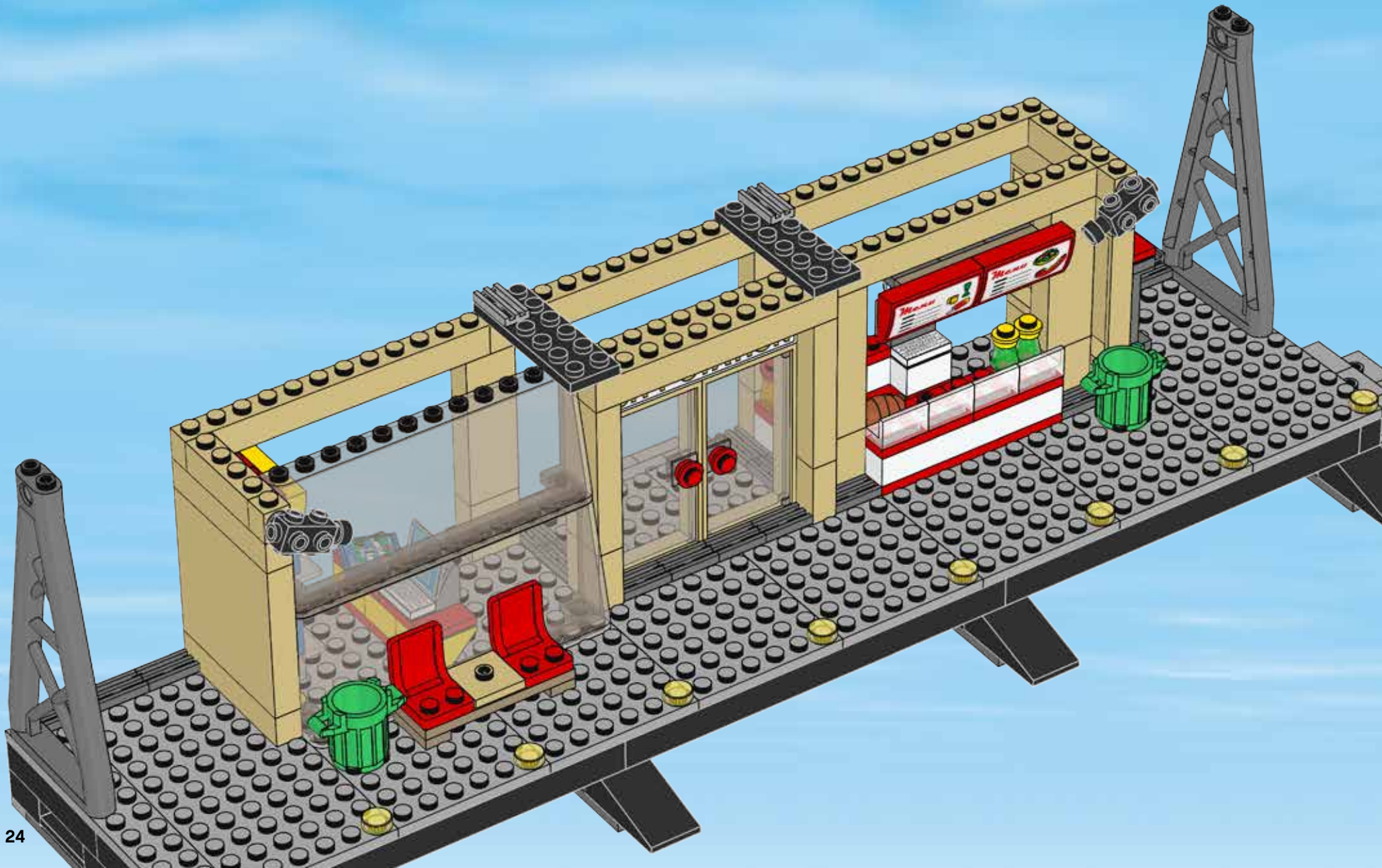

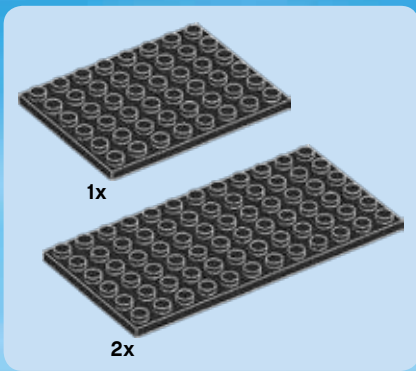

60





1x



5x

61

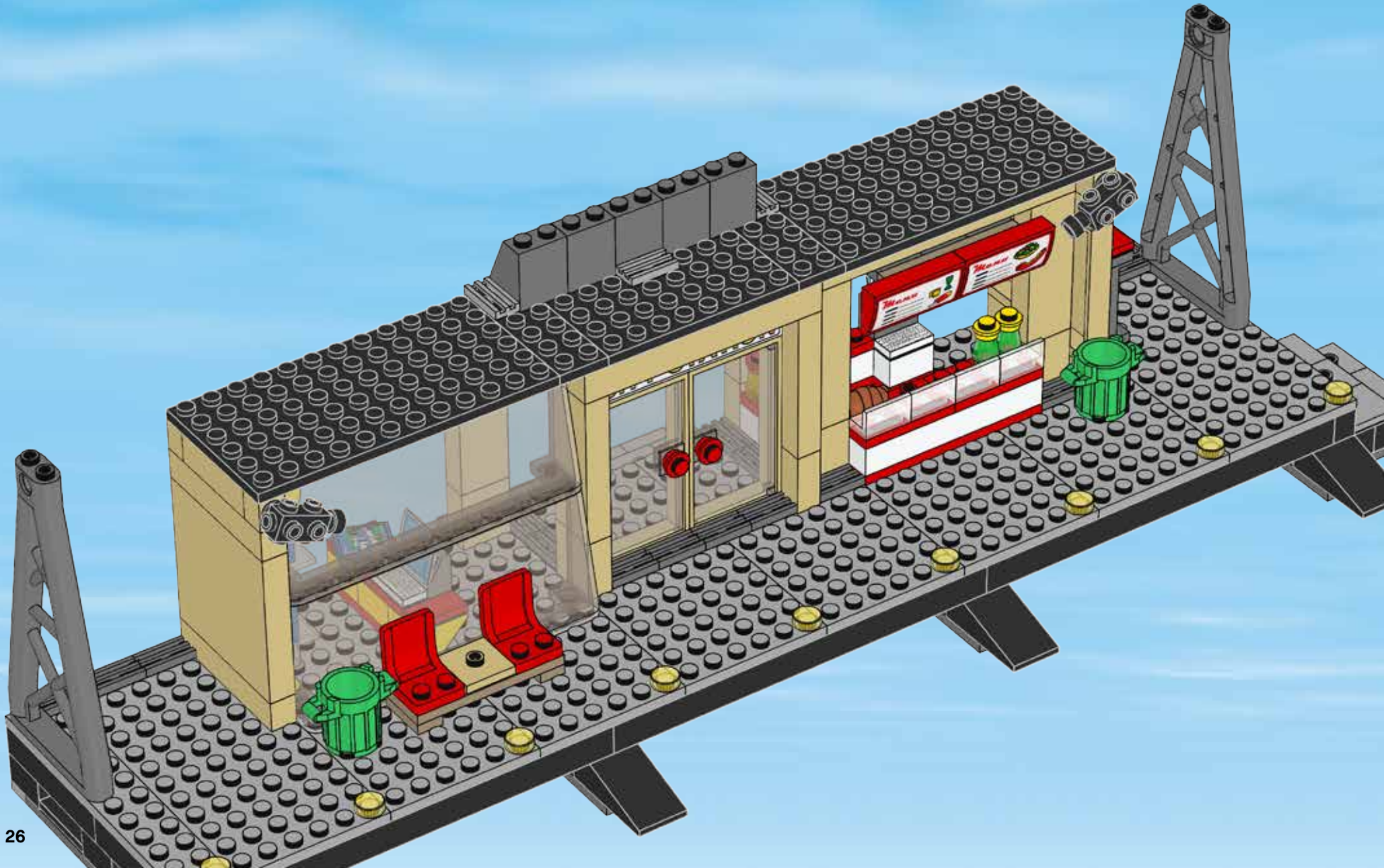



2x



2x

62

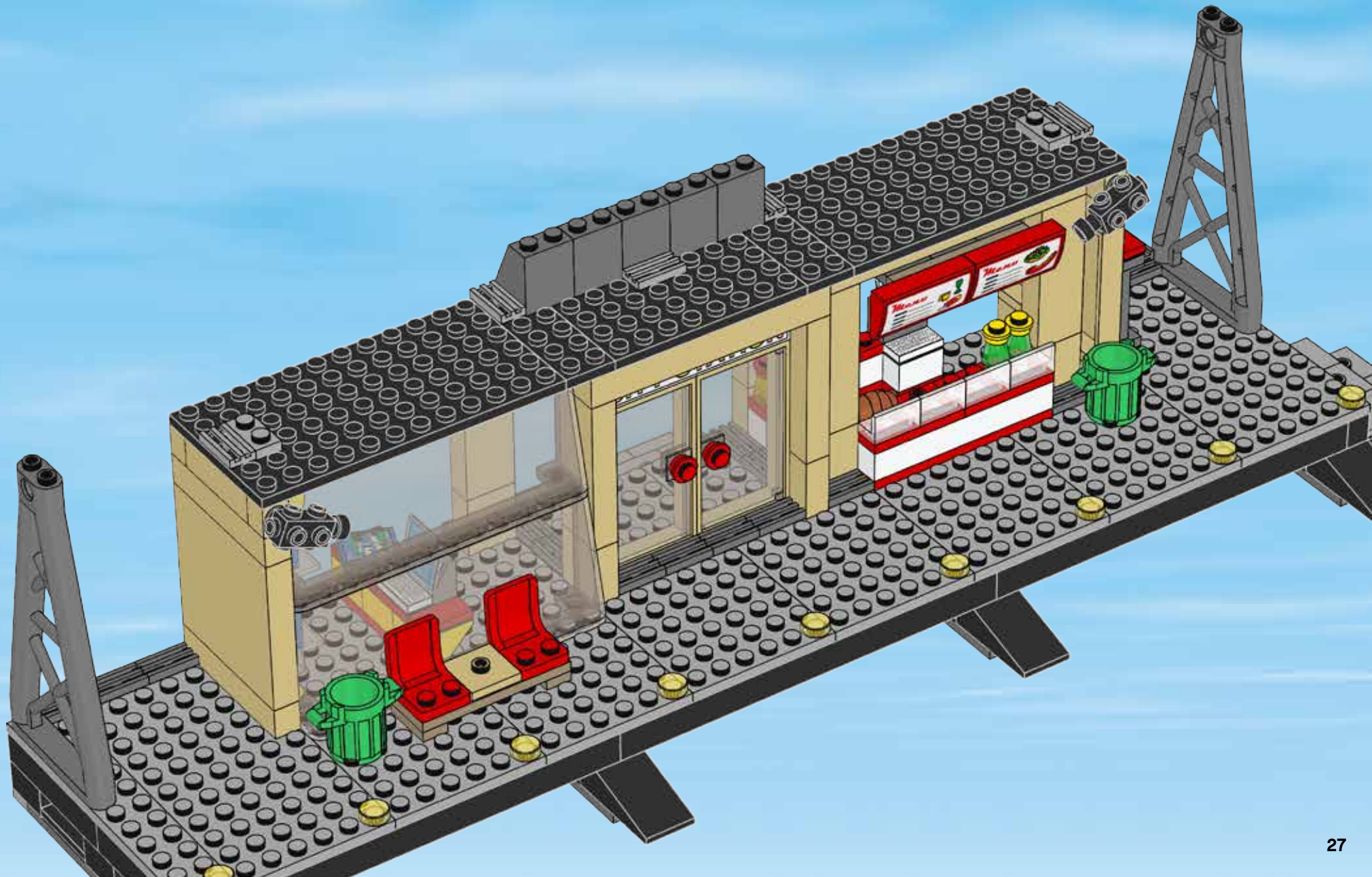



63

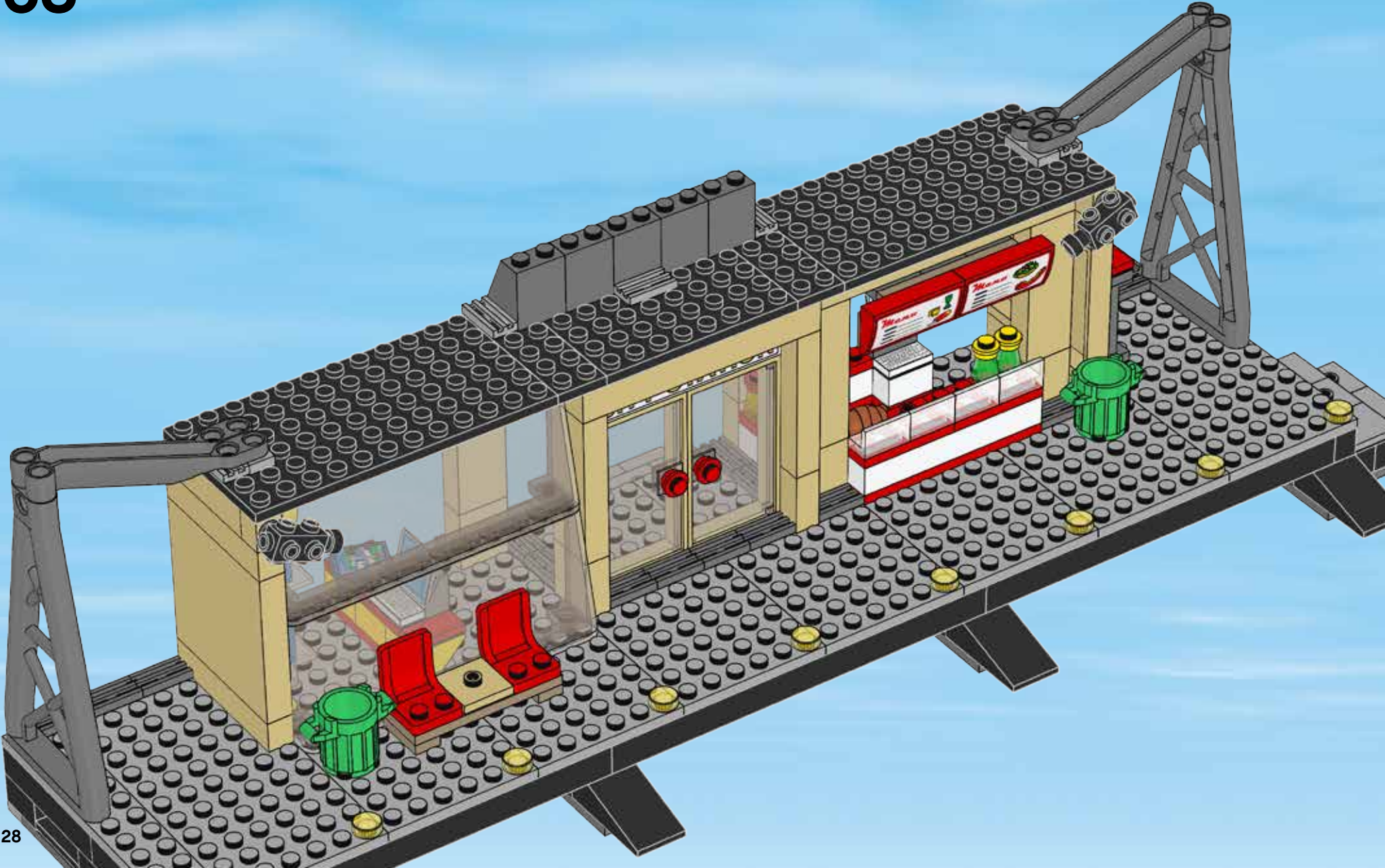



4x

64

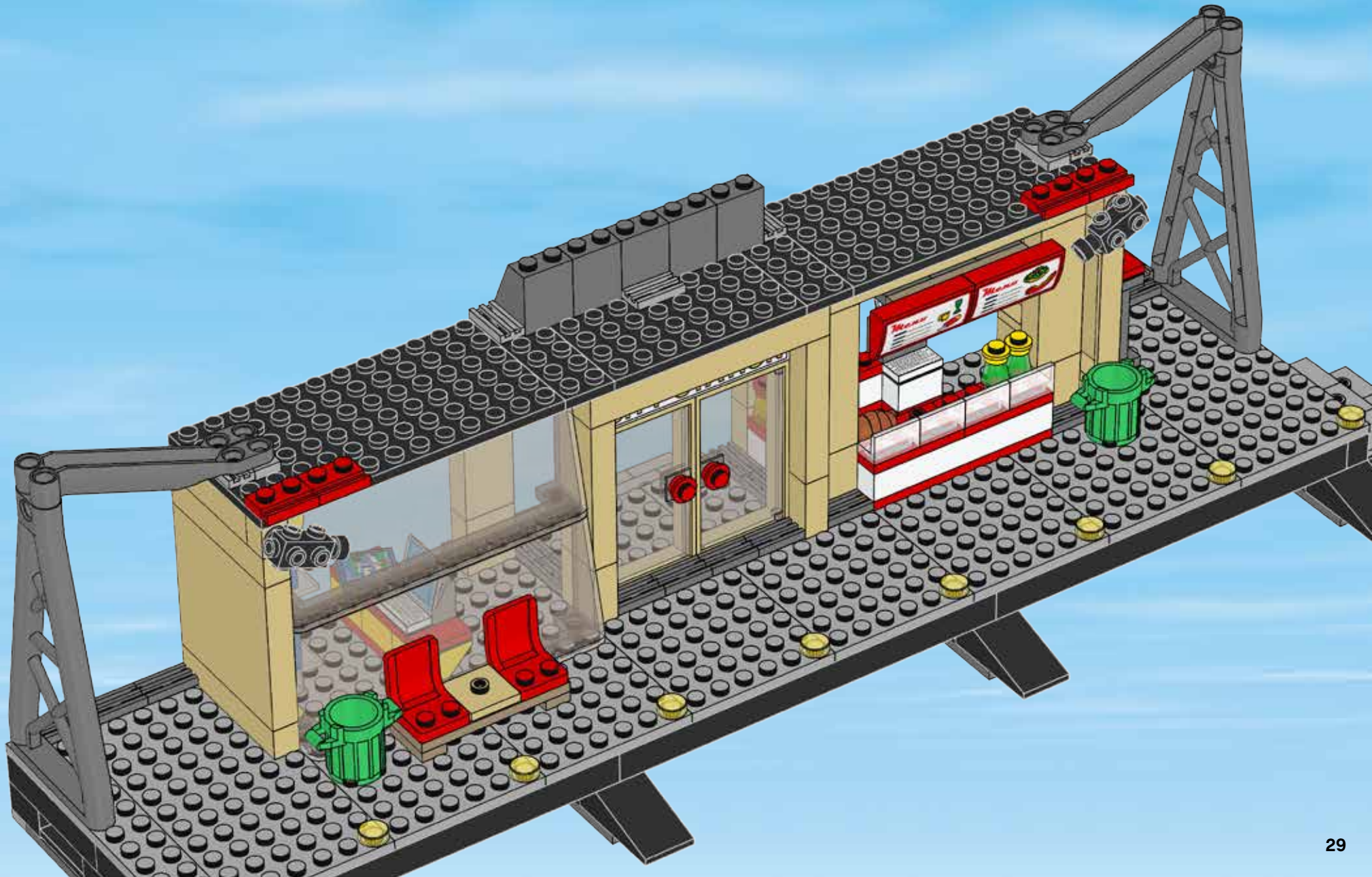

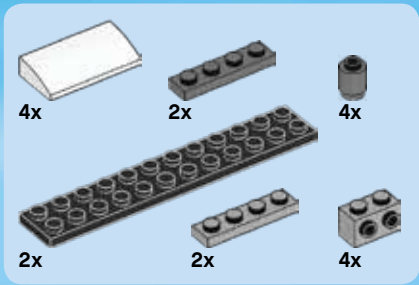

65

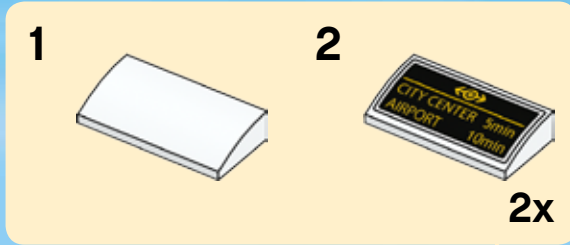
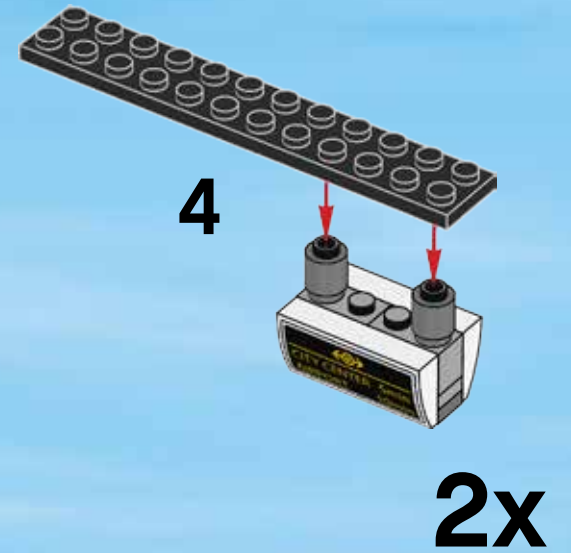
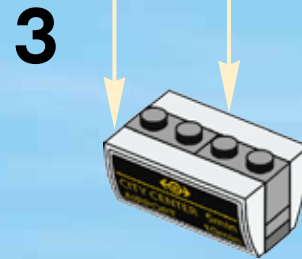
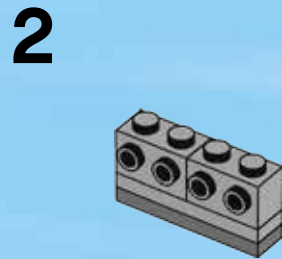
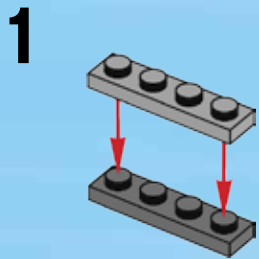

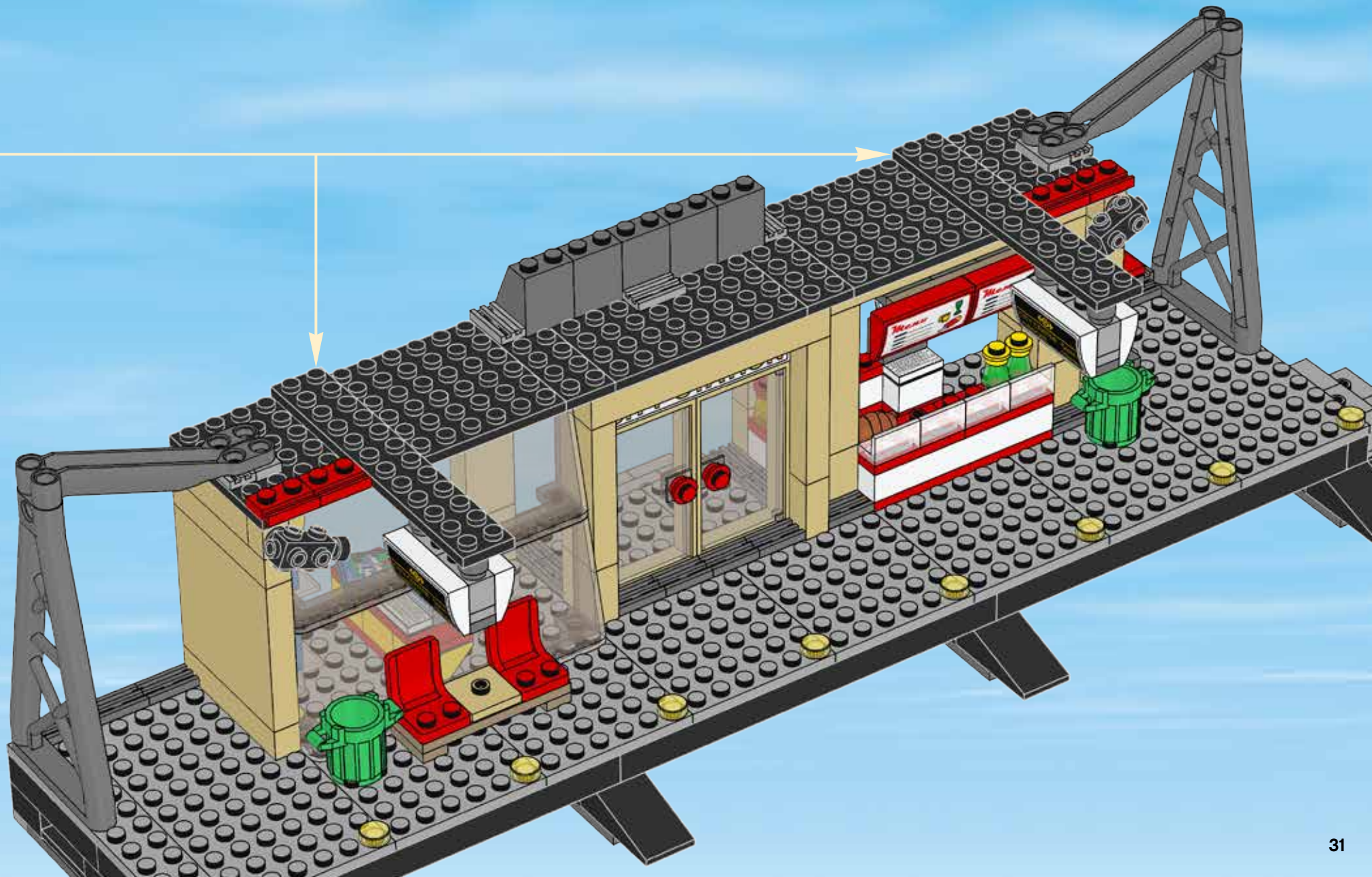

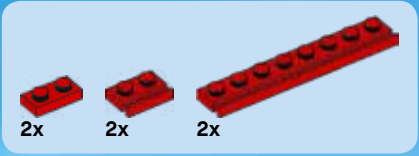

66

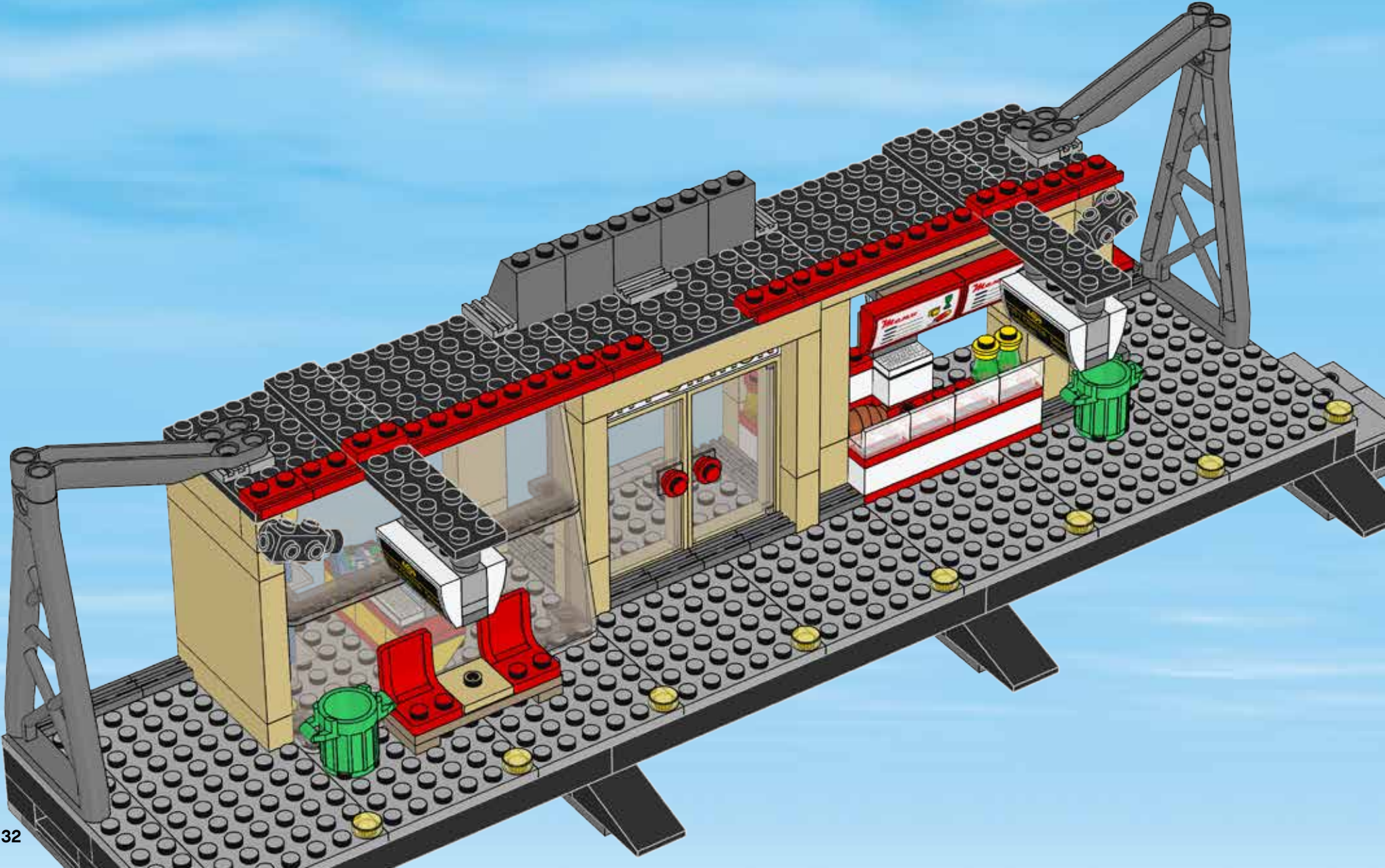

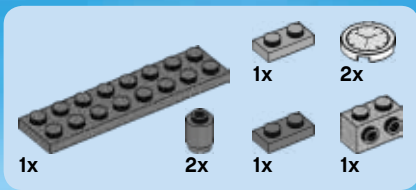

67

1

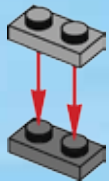

2

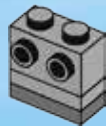

3

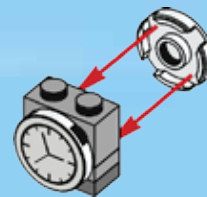

4

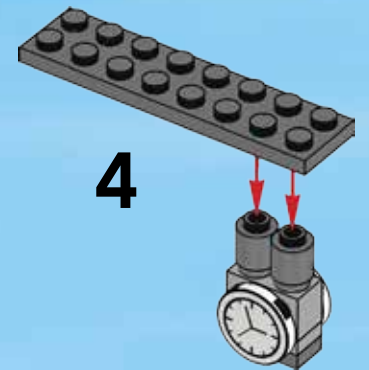

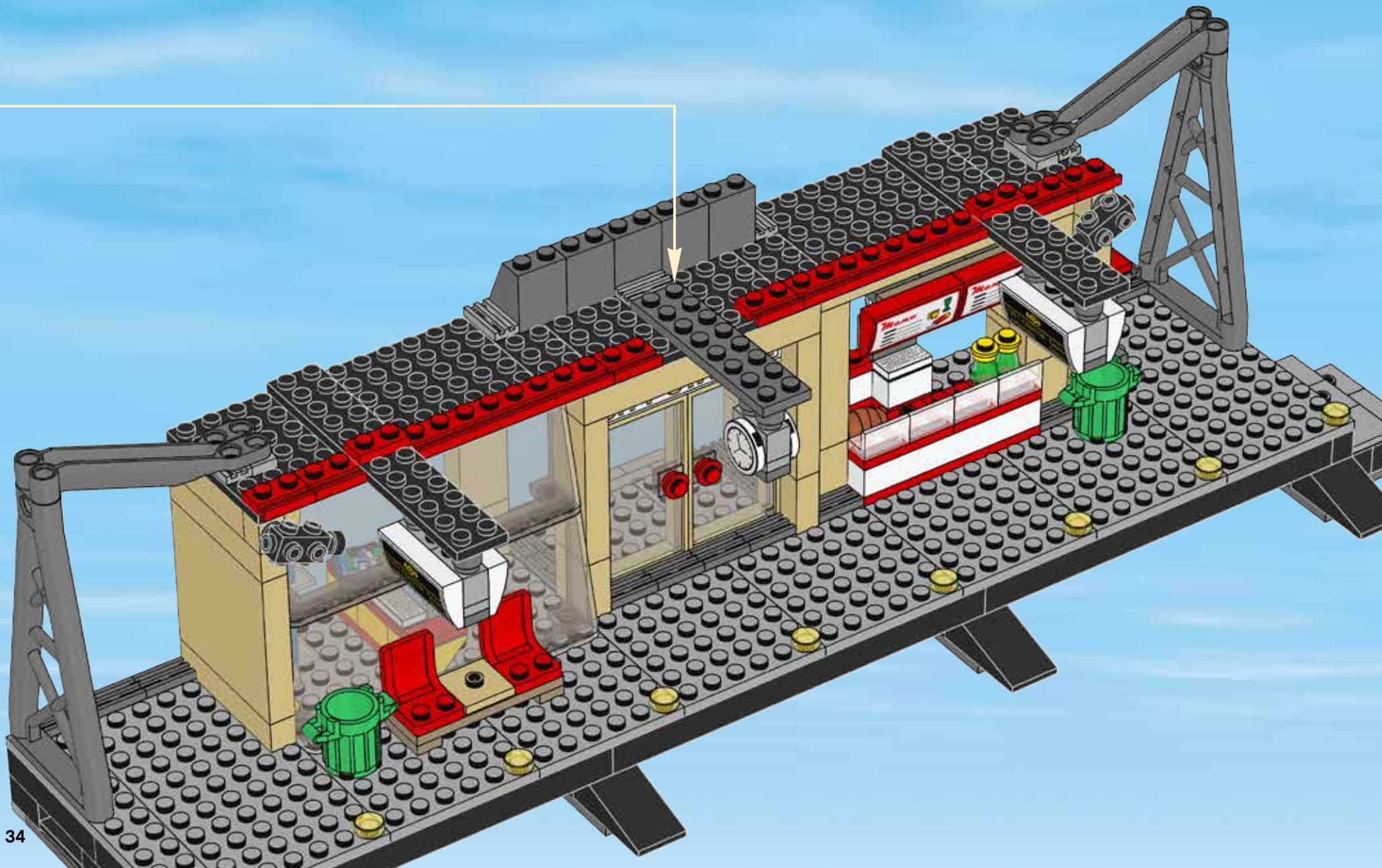



1x

68

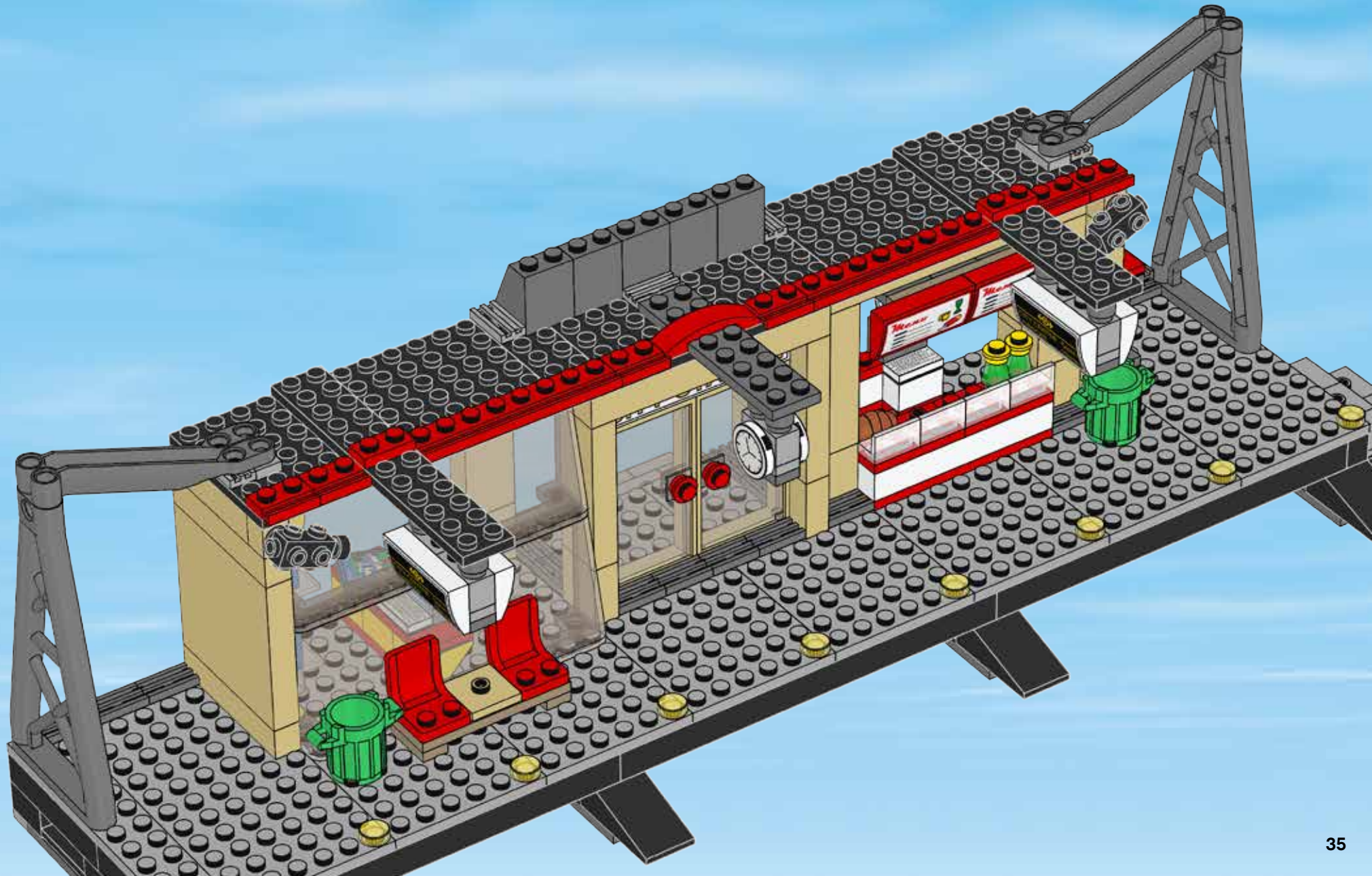

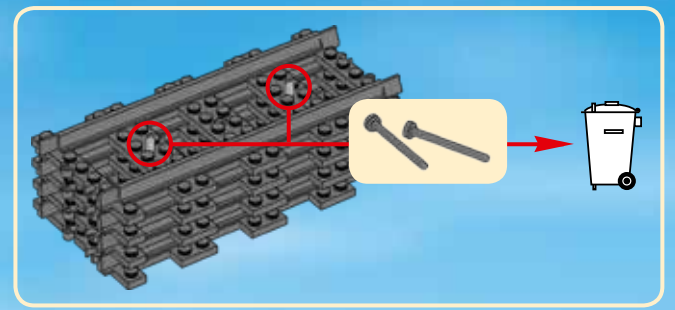
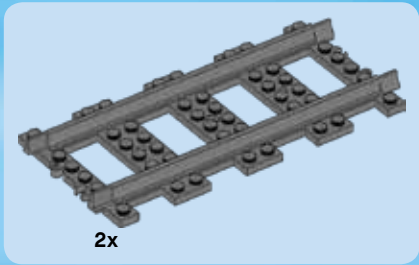

1

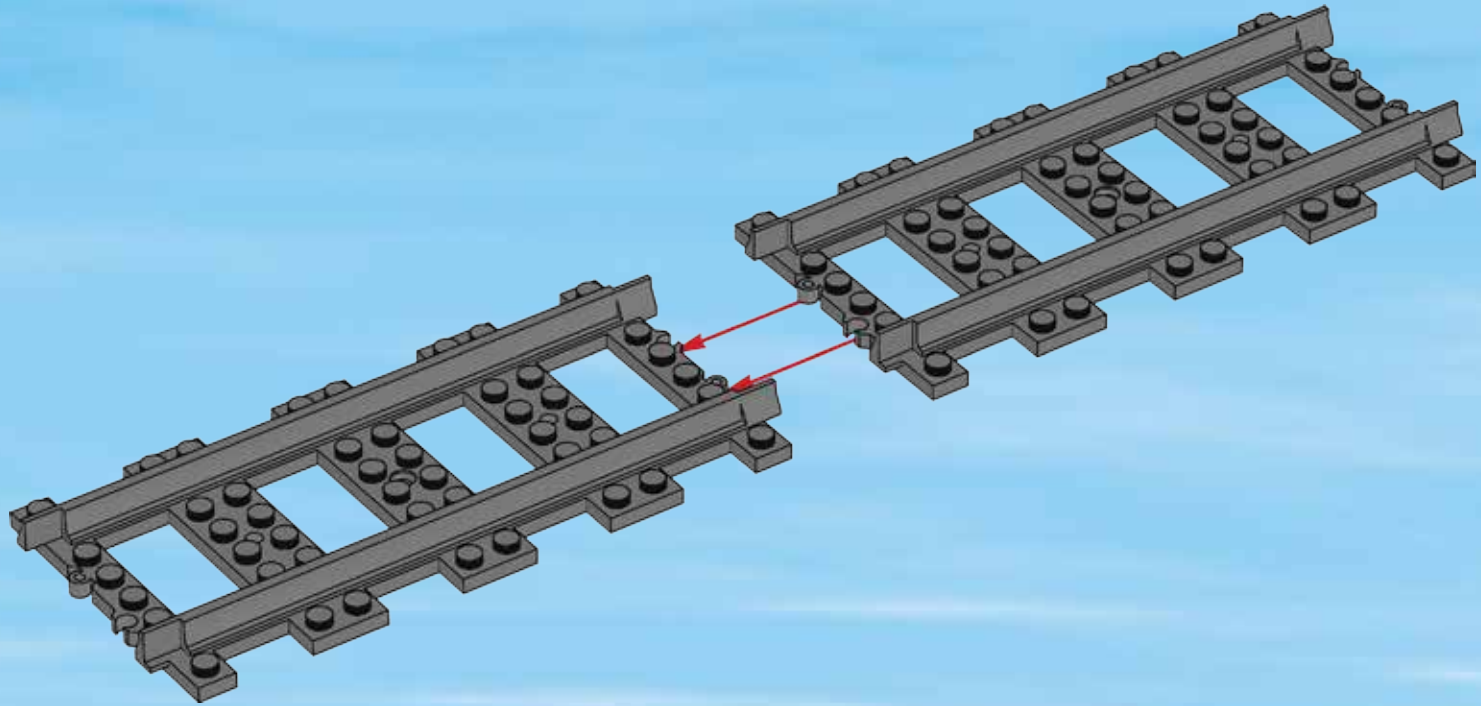



2x

2

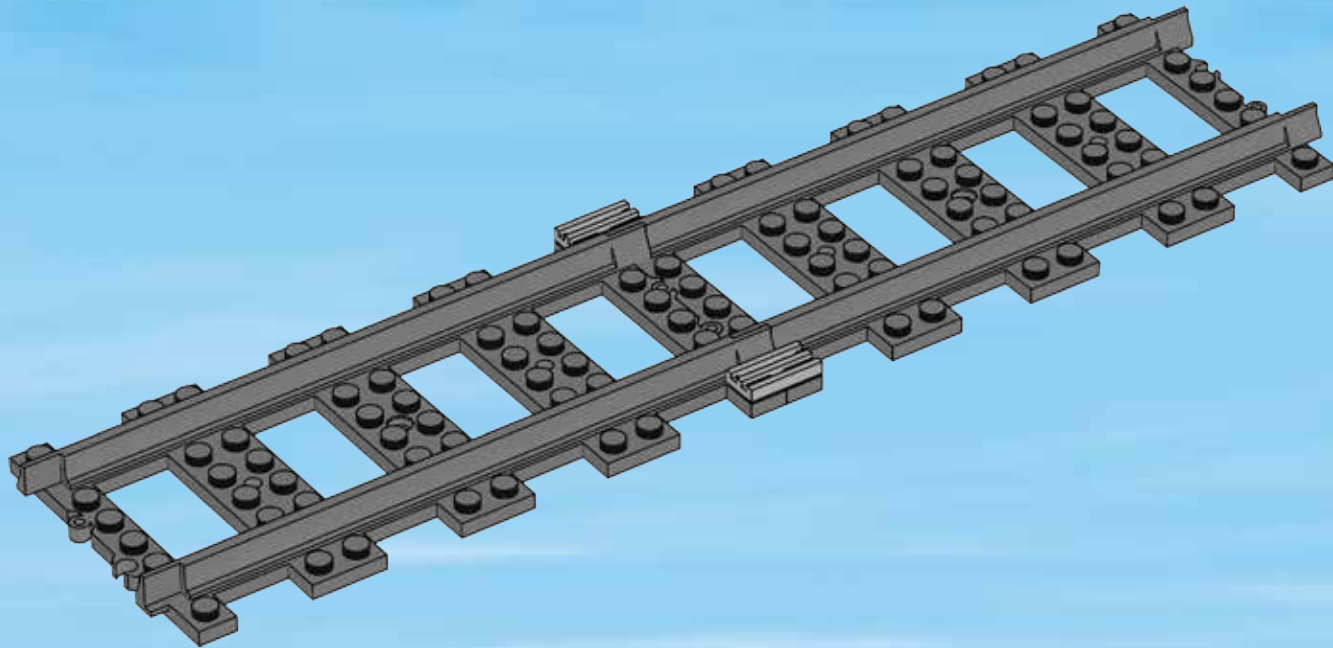



2x

3

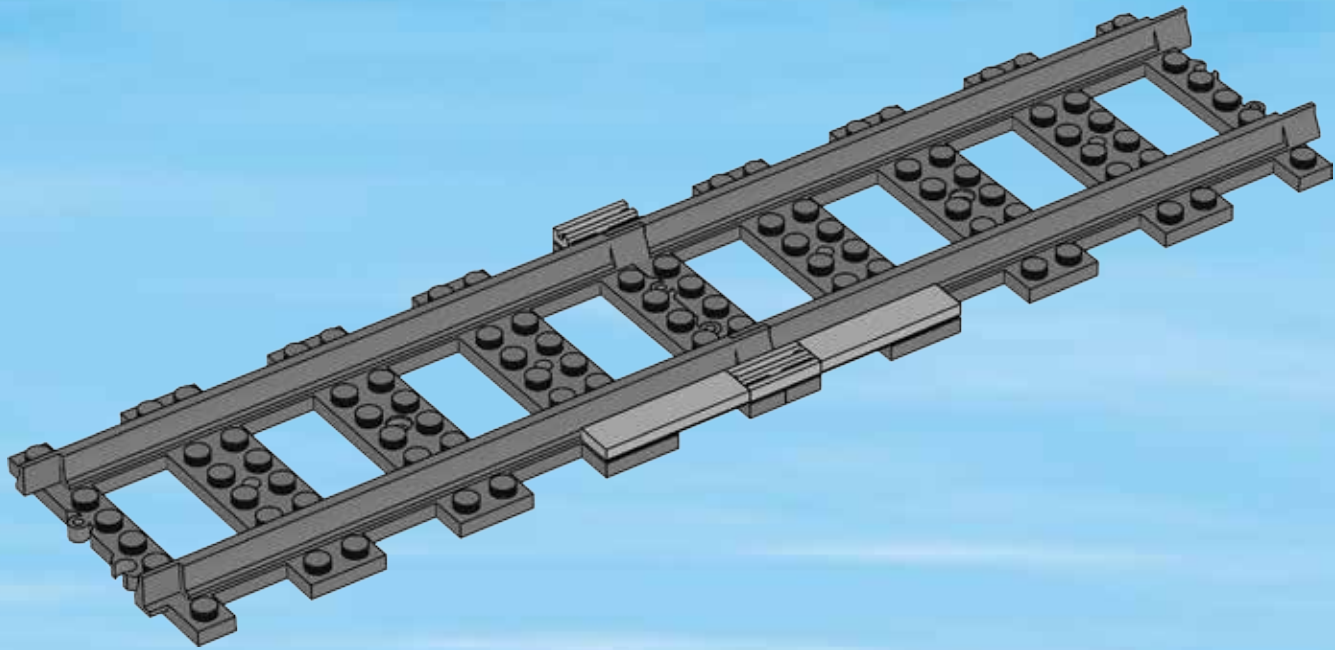

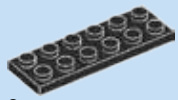

2x

4

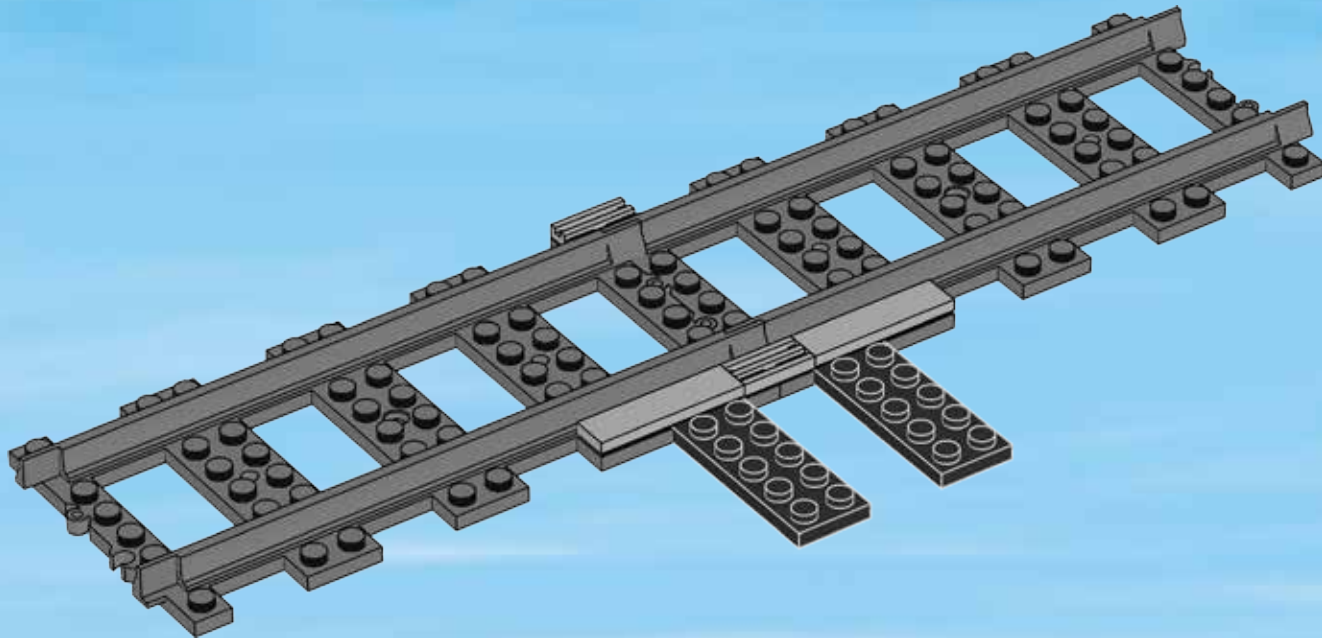

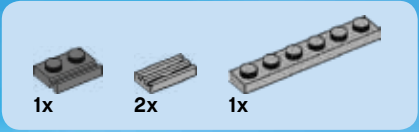

5

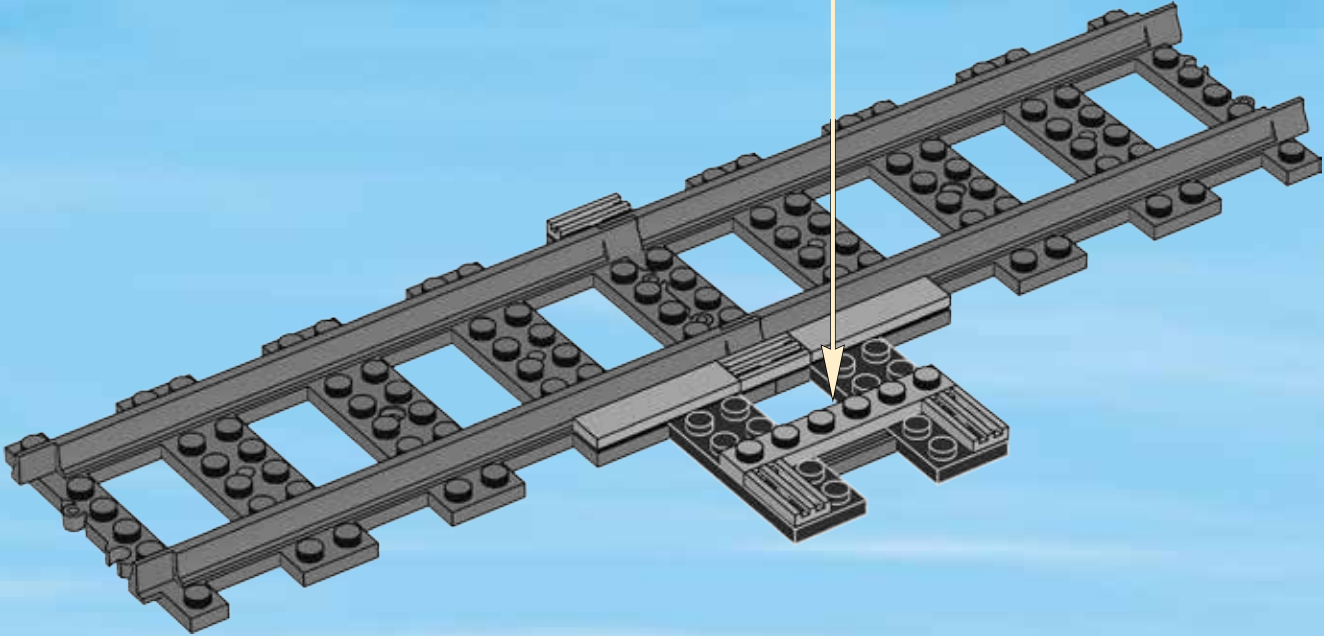
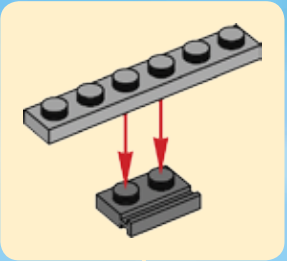

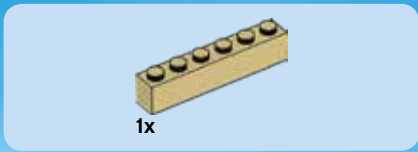

6

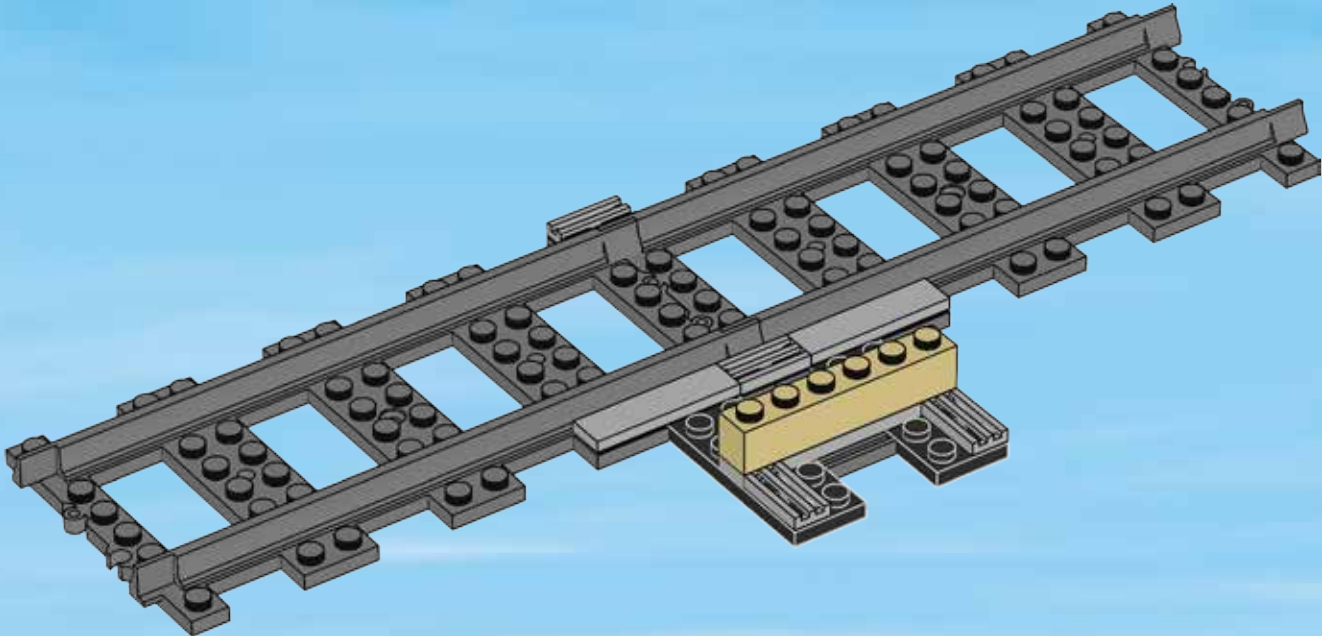

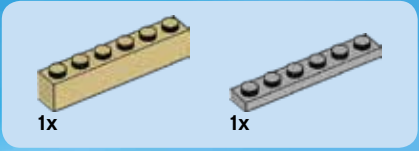

7

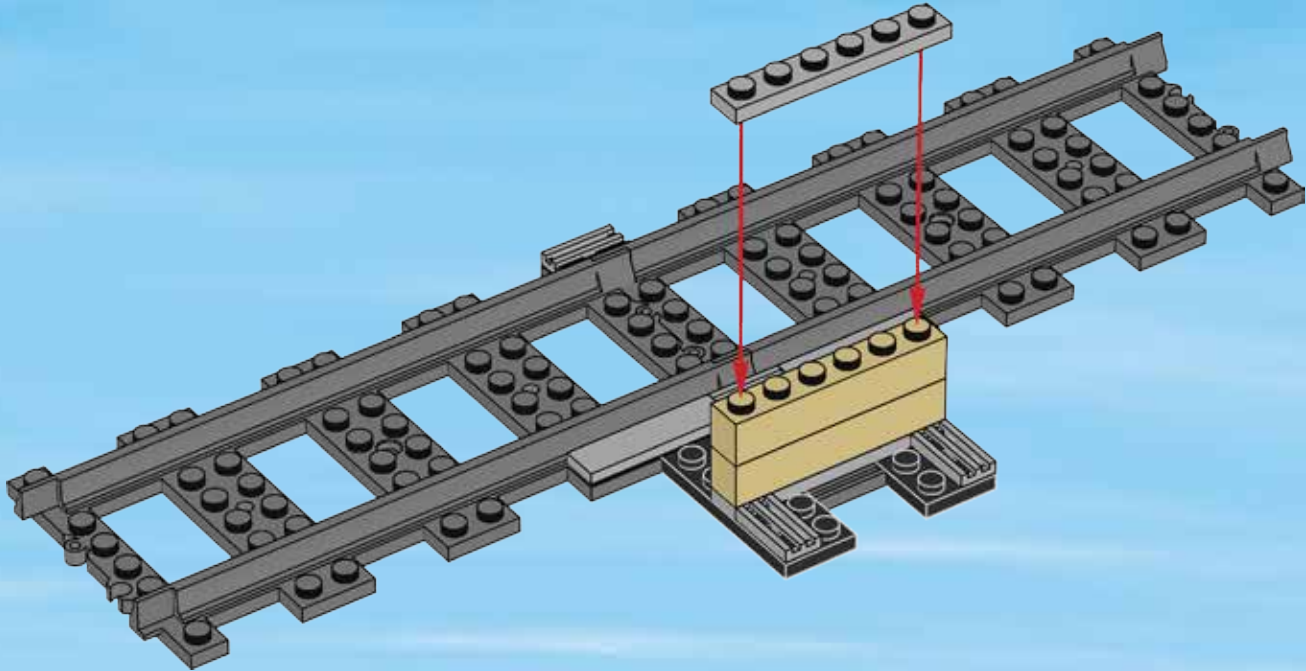

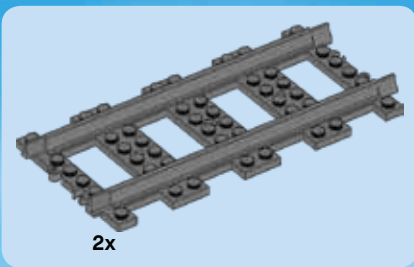

8

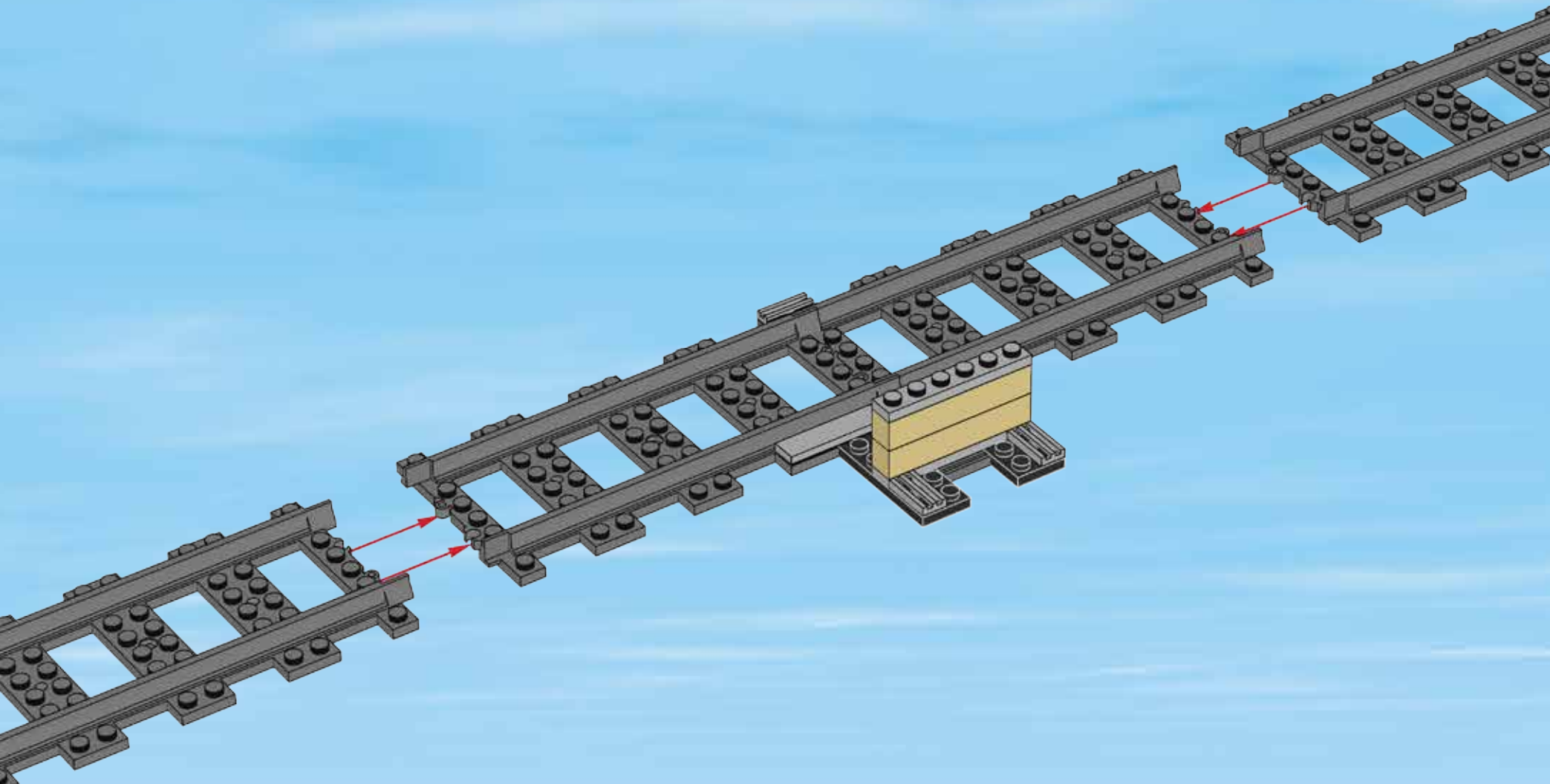

69

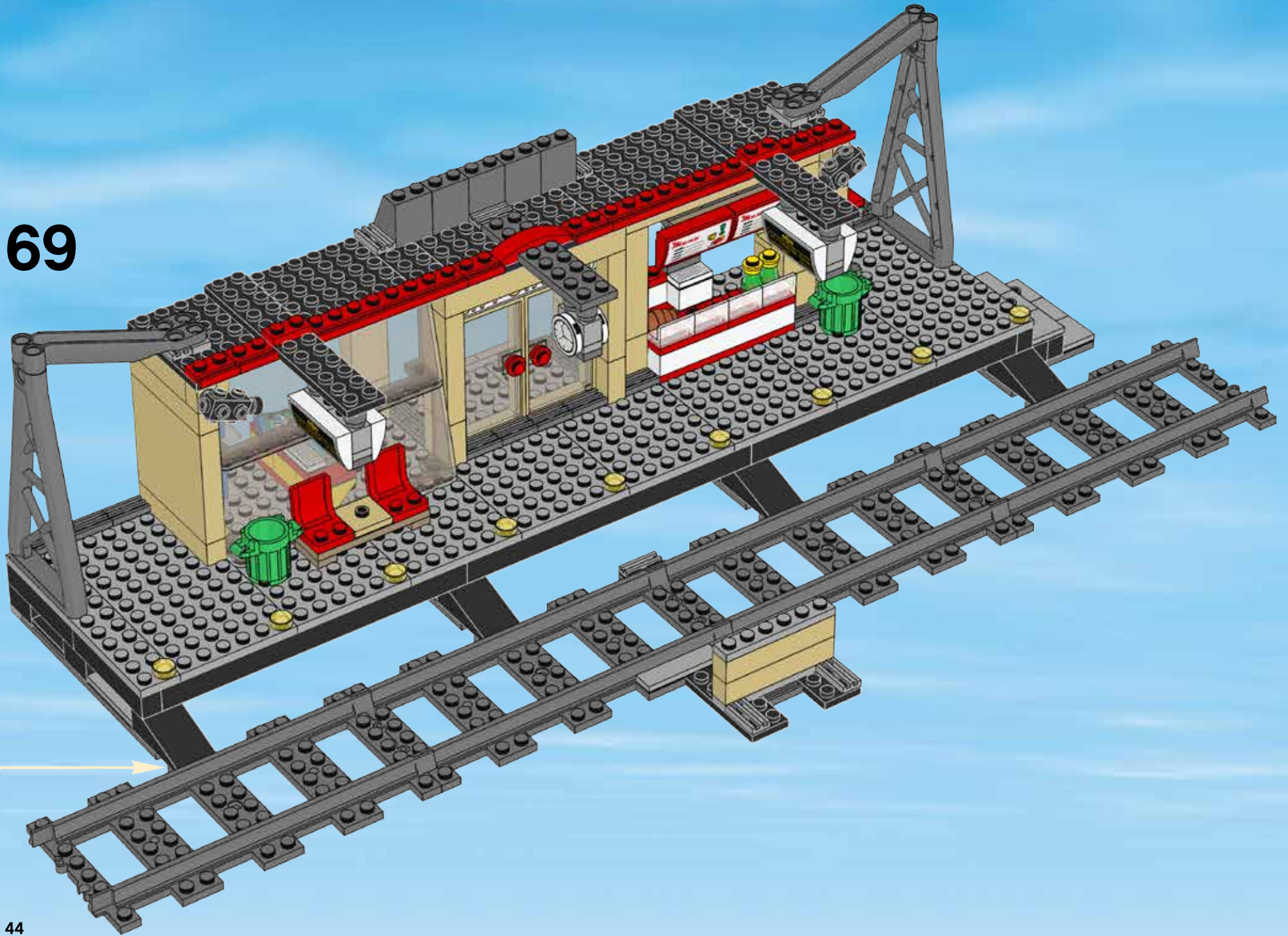

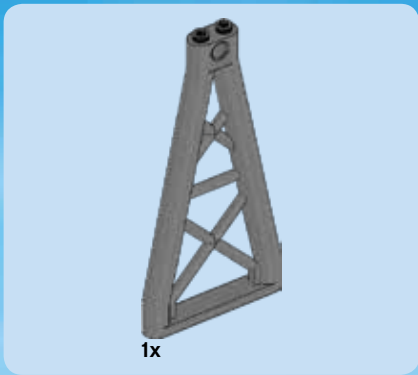

70

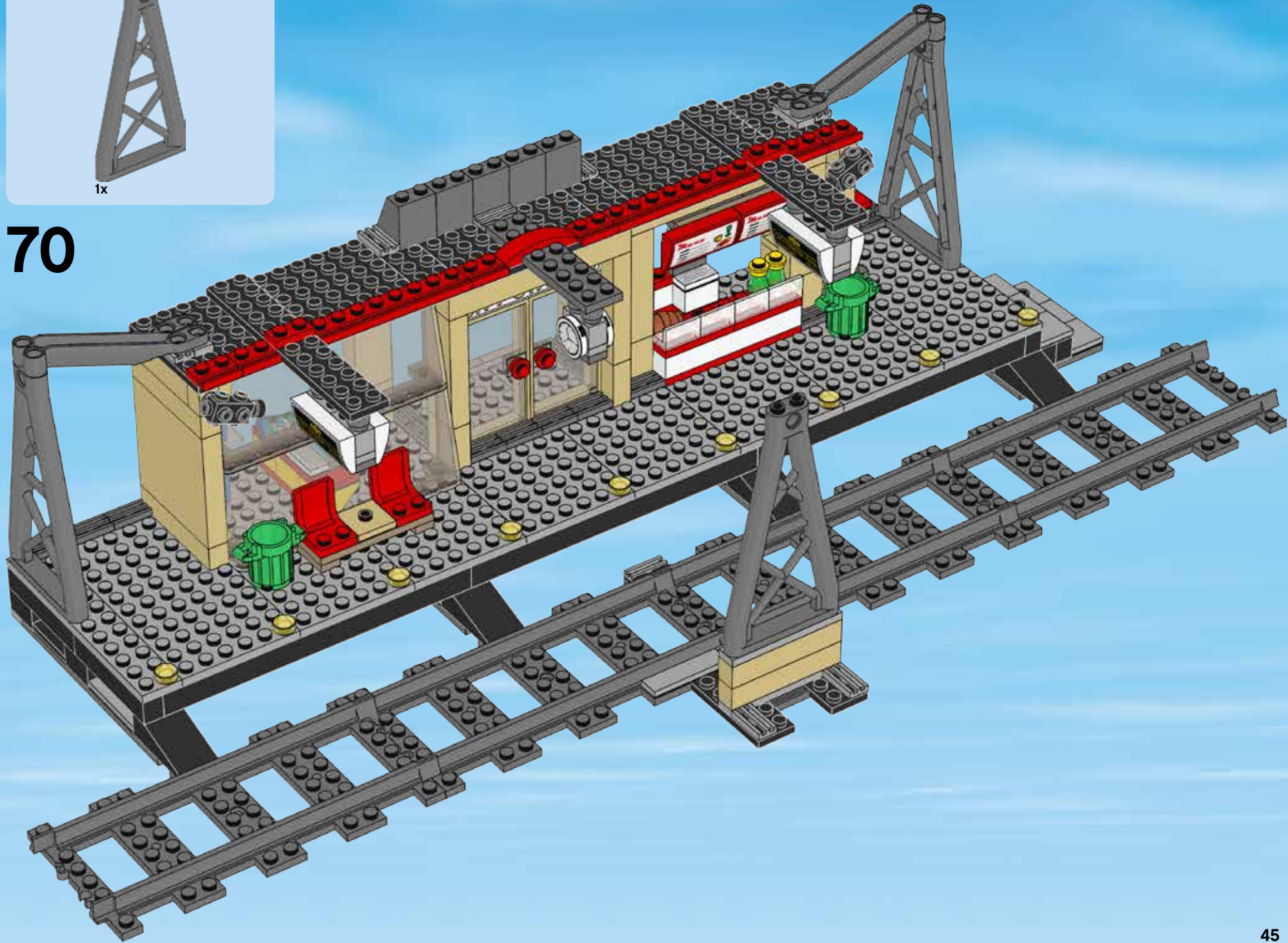

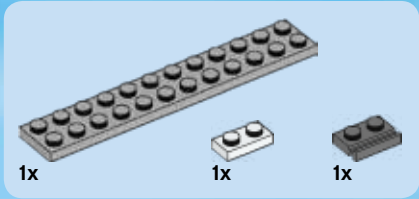
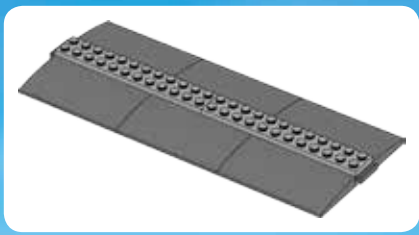

1

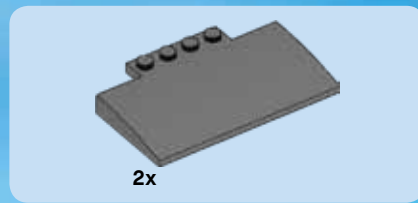
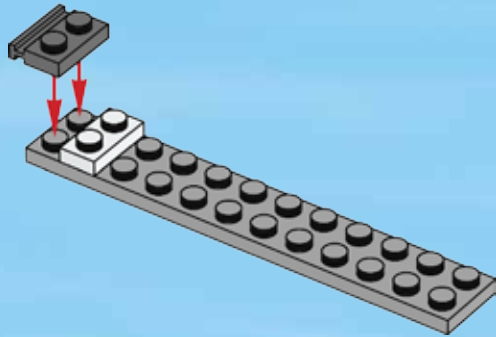

2

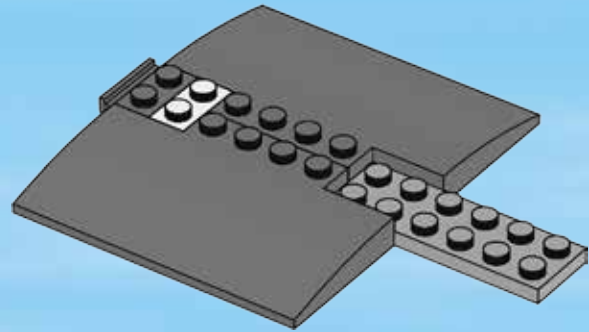



1x

3

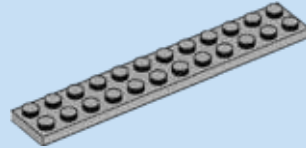
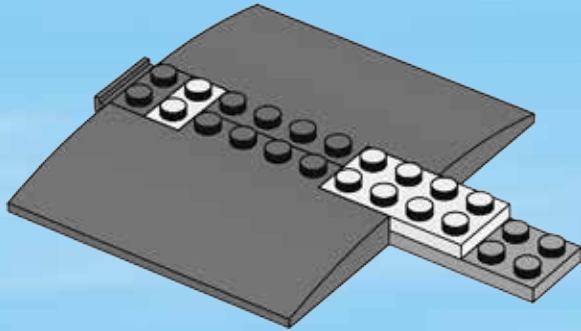

1x

4

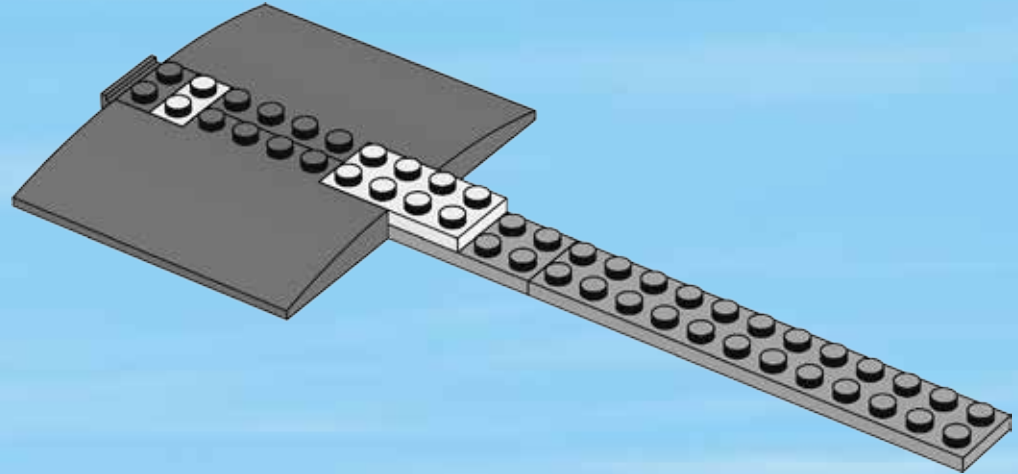

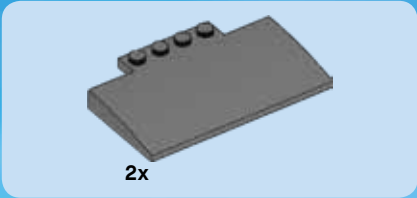

5

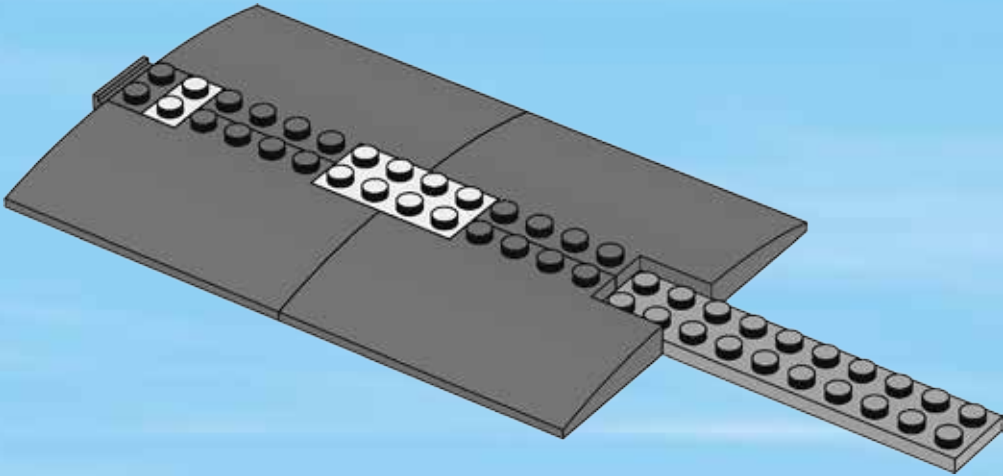

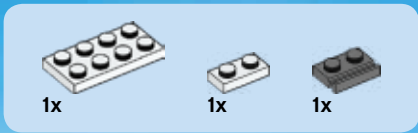

6

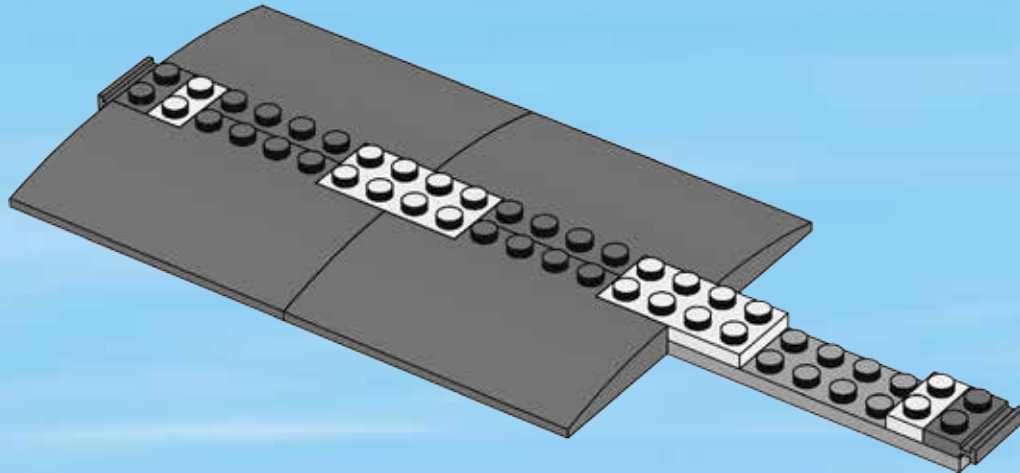

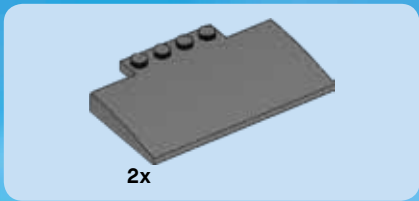

7

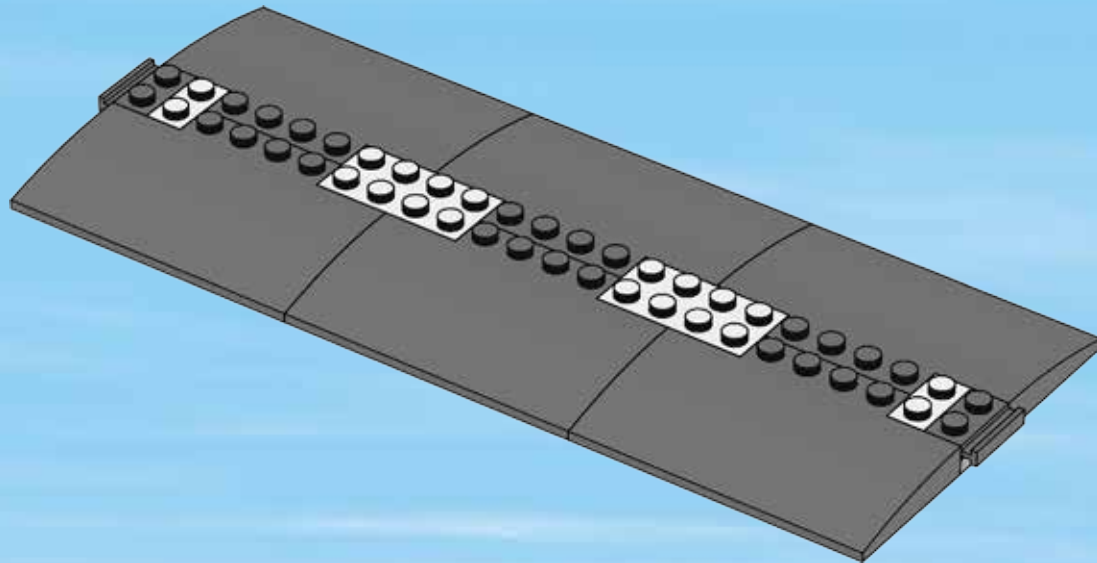

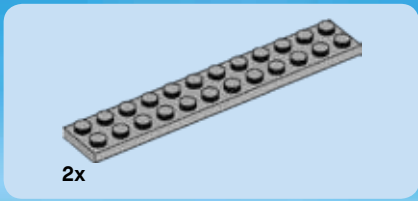

8

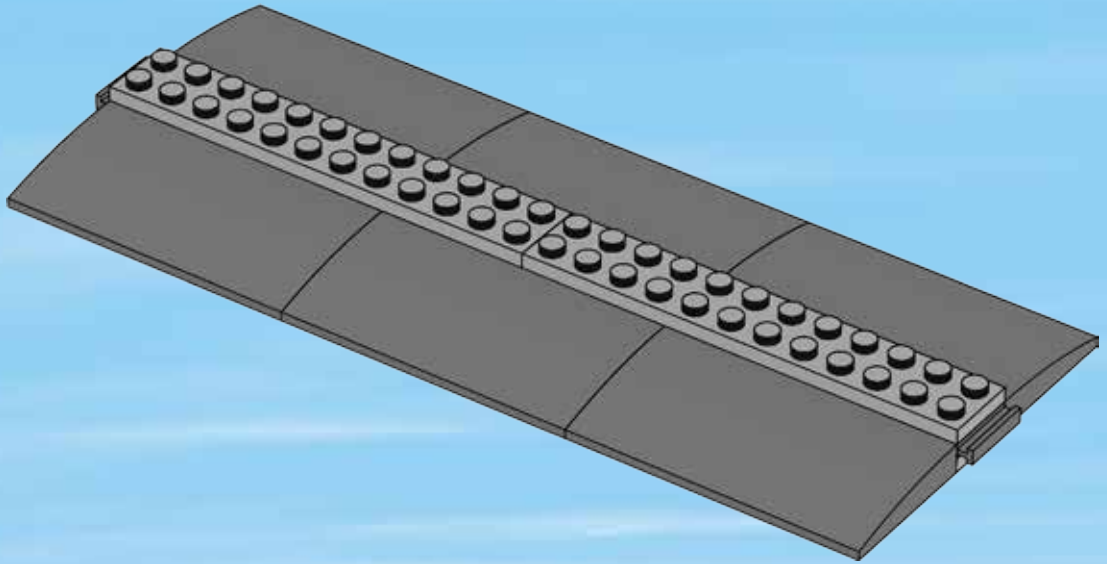

71

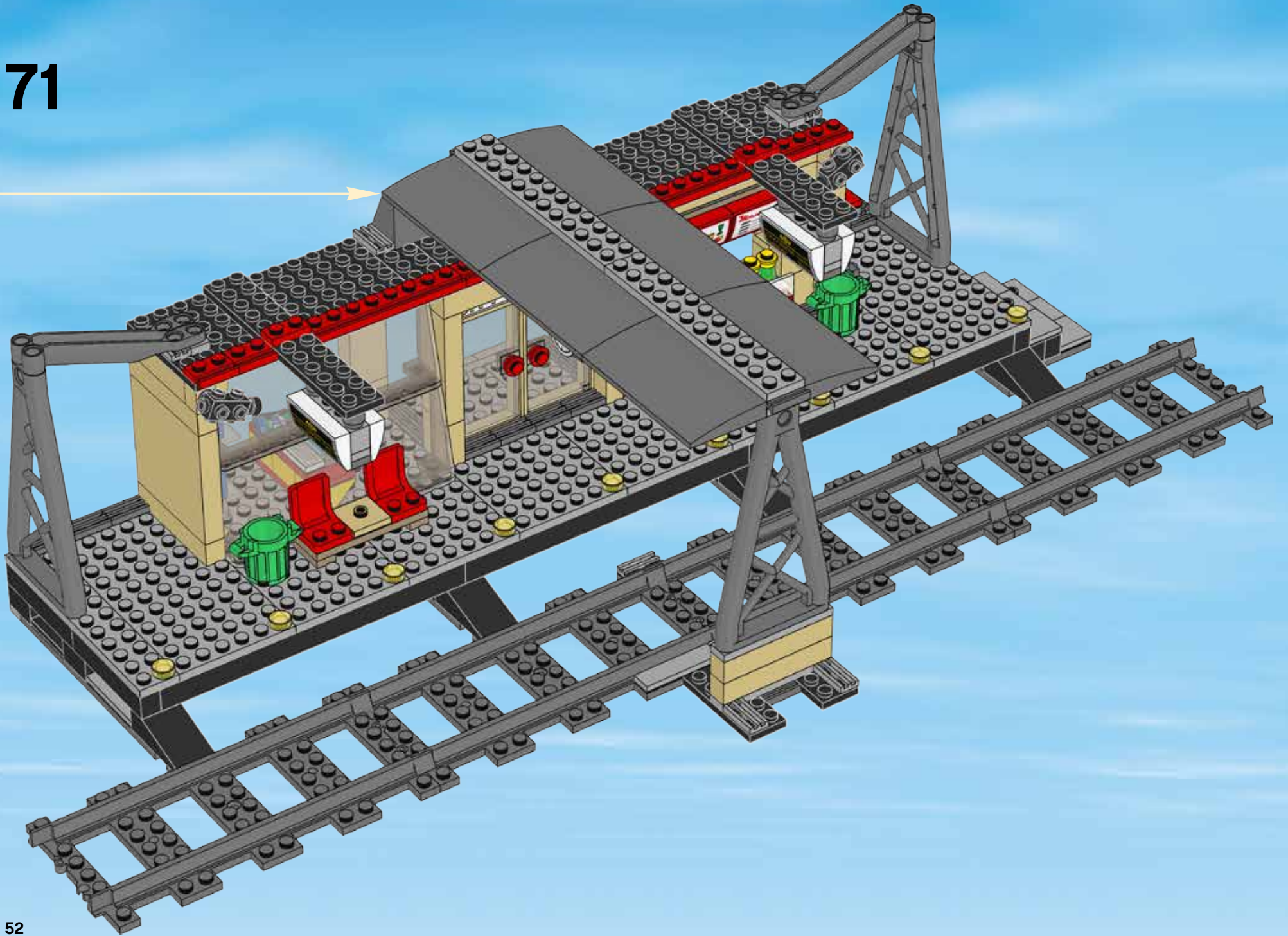



CITY



60130



60129



60128



60127



60126



[LEGO.com/city](https://www.LEGO.com/city)

1x
300401

1x
300201

1x
300901

1x
300801

1x
6033776

4x
4583297

1x
306901
2x
302301

2x
302001

2x
6052201
2x
4293350

1x
4655208

1x
4289304

1x
9327

1x
4275540

54

1x
4249741

1x
390001

6x
4159279

6x
4114064

1x
4114306

3x
4113916

6x
4112982

1x
4615599

4x
6075179

2x
4579260

1x
4565387

2x
4578110

2x
4512688

2x
300421

5x
4157223

1x
4633914

2x
4597912

3x
302321

2x
306921
2x
379421

1x
306821

1x
302221

1x
4581308

2x
302121

7x
371021

1x
4113858

2x
366621

1x
303421

6x
4612575

2x
6078594

4x
614121

2x
407921

1x
6032232

1x
4520952

2x
306923

3x
306823

1x
302023

1x
9341

1x
9566

2x
6092655

2x
4504381

2x
4550348

3x
366024

2x
4503844

2x
4597902

2x
307024

2x
242024

2x
371024

1x
6102555

3x
614124

2x
6092648

1x
4506727

1x
4200908

1x
6021844

1x
6021614

1x
4651443

1x
389924

4x
4288594

1x
4646504

3x
300526

8x
300326

5x
300926

1x
611126

1x
4617860

9x
246526

1x
4548180

4x
4185583

1x
241226

1x
306926

1x
302326

4x
4558170

2x
371026

4x
379526

1x
303626

2x
244526

2x
302826

2x
4598528

2x
4523339

1x
4521681

2x
6064043

1x
9339

1x
4526110

4x
4568644

2x
4626650



club™

