



CITY

60139



LEGO.com/city







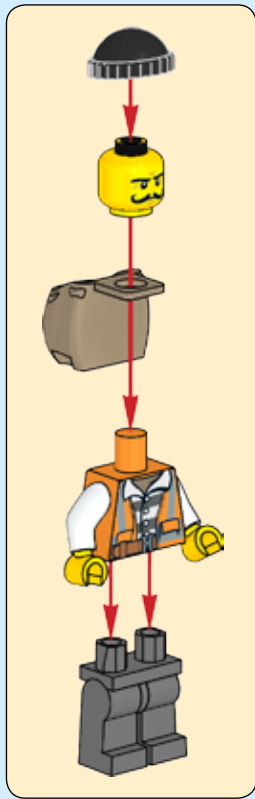



1

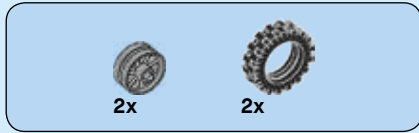

2

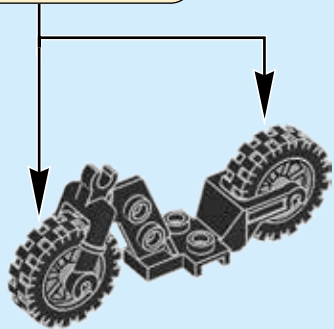
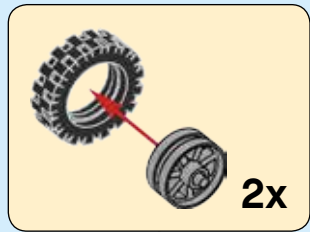

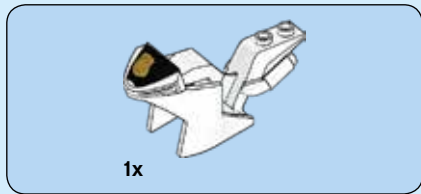

3

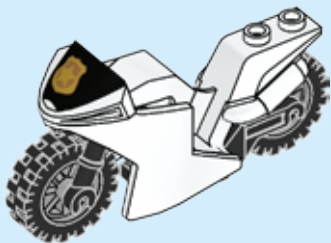



1x

4

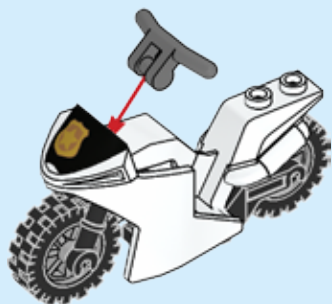

5





2x

6



8



1x

7



8

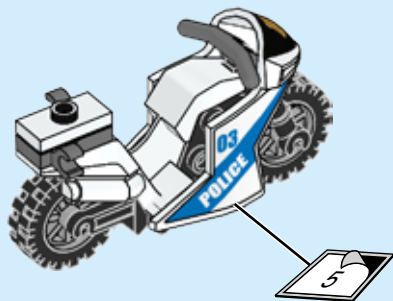
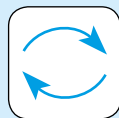



9

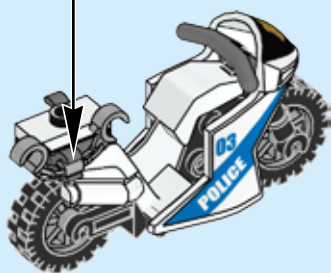

10



1x



1x

10

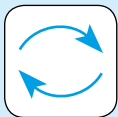

1x

11





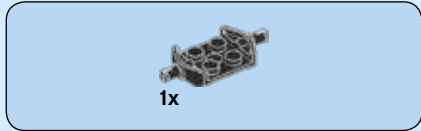
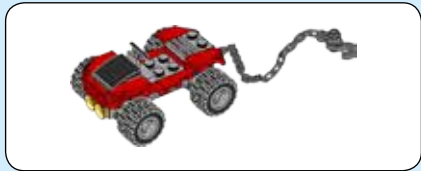

1



2





1x

3

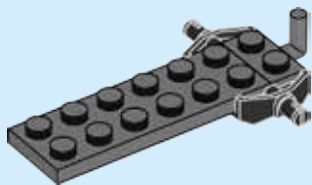

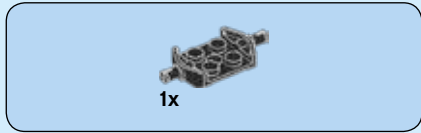

4

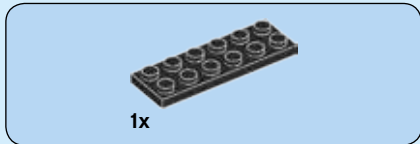
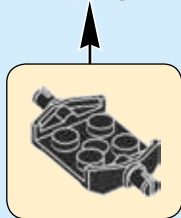
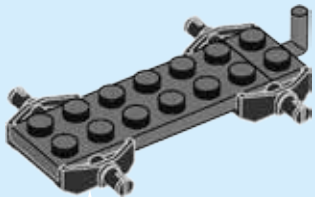

5

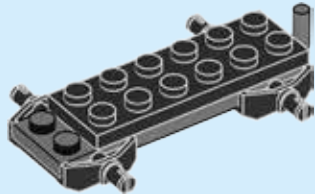



1x

6

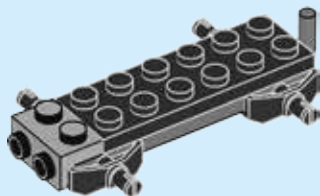

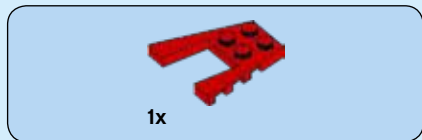

7

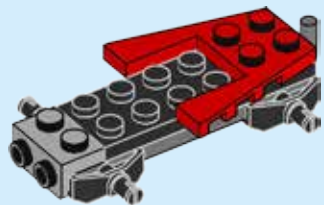

8

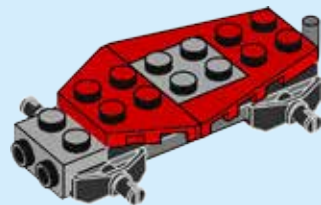



1x

9

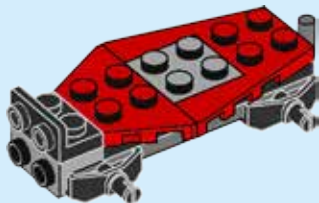



2x

10

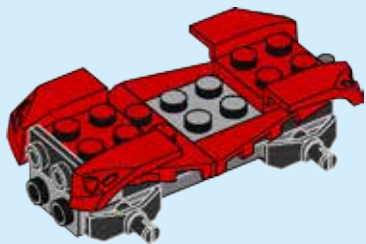

1x



1x

11

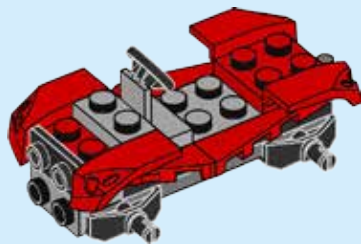



1x

12

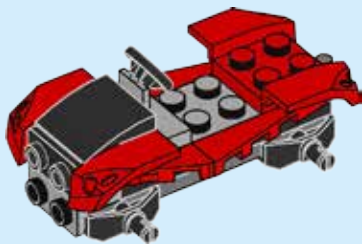



1x



2x

13

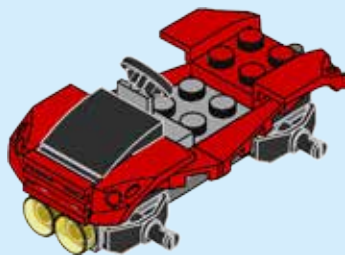

1x



1x

14

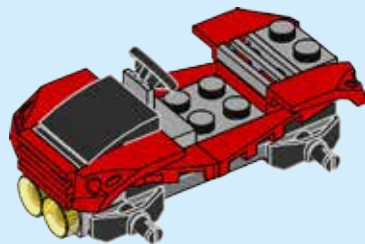

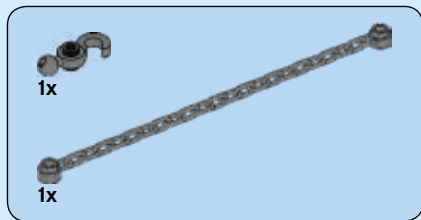

15

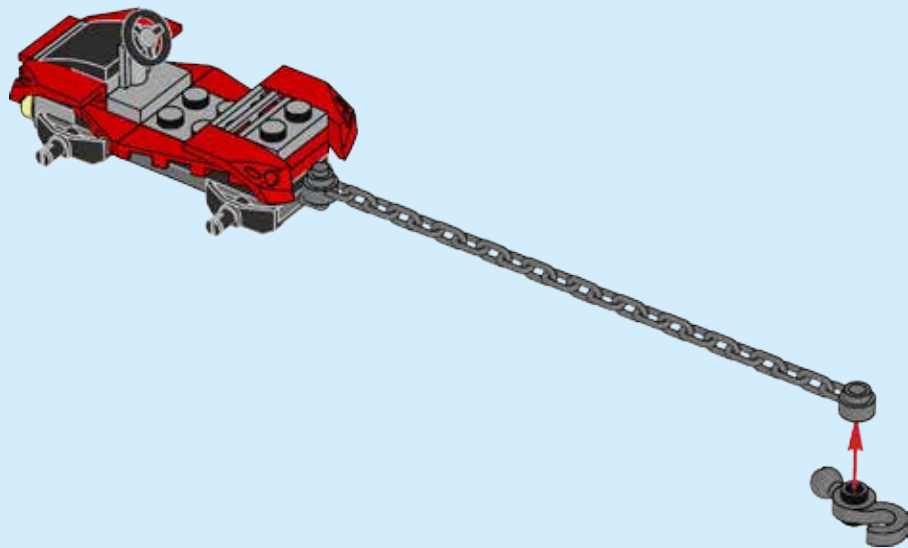

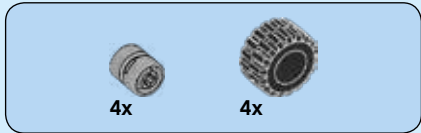

16

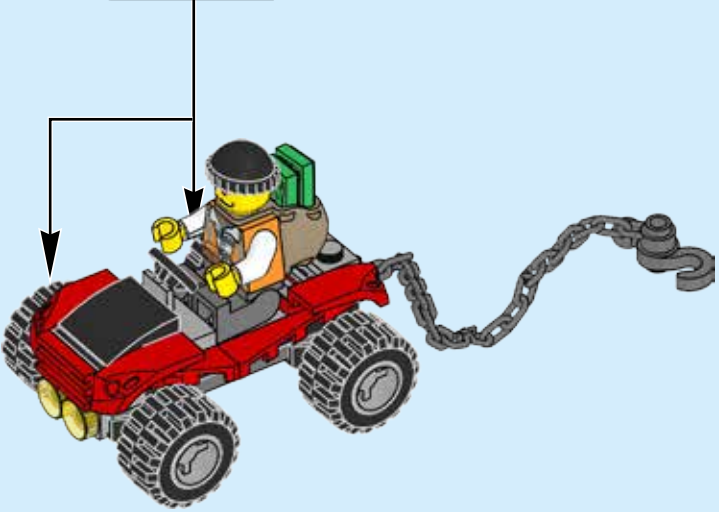
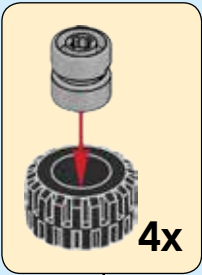

WIN

GO TO WWW.LEGO.COM/PRODUCTFEEDBACK AND
GIVE US YOUR SHORT **FEEDBACK** ABOUT THIS
LEGO® SET FOR A CHANCE TO WIN
A COOL LEGO PRIZE.

Terms & Conditions apply



LEGO.com/productfeedback

GEWINNE



Erzähle uns auf
www.LEGO.com/productfeedback

etwas über die Erfahrungen, die du mit
diesem LEGO® Set gemacht hast, und
sichere dir die Chance auf einen coolen
LEGO Preis!

Es gelten die Teilnahmebedingungen

GAGNE



Rends-toi sur
www.LEGO.com/productfeedback

et donne-nous quelques commentaires sur
ce produit LEGO® pour avoir une chance
de gagner un prix LEGO !

Voir Conditions Générales

GANAN



Visita
www.LEGO.com/productfeedback

y envíanos tu opinión acerca de este set
LEGO®. ¡Participarás en el sorteo de un
premio LEGO!

Términos y Condiciones aplicables

获取奖品



登录
www.LEGO.com/productfeedback

给出关于此乐高®套装的简短反馈，
就有机会获得炫酷乐高奖品

《条款及条件》适用

LEGO and the LEGO logo are trademarks of the LEGO Group. ©2017 The LEGO Group.

6188723



CITY

60139



[LEGO.com/city](https://www.lego.com/city)



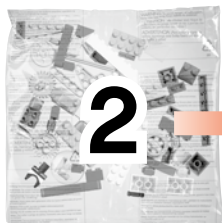

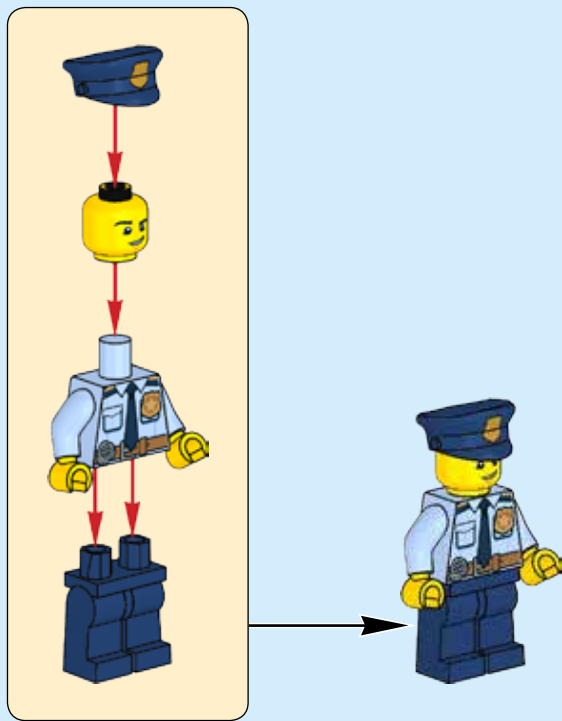

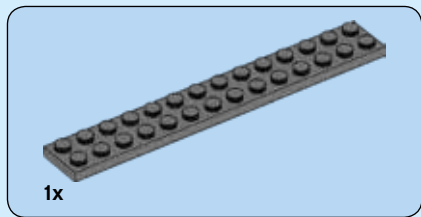

1

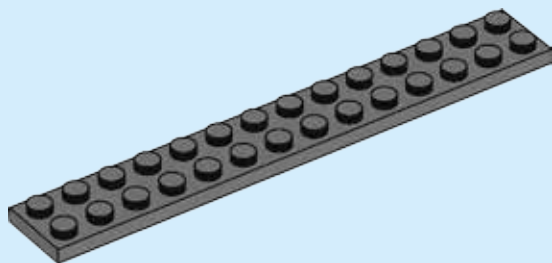

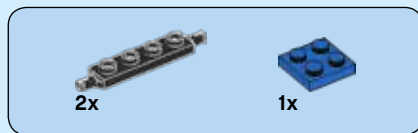

2

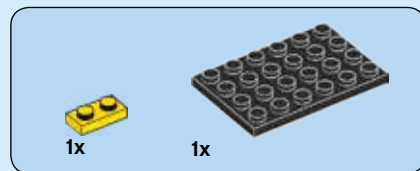
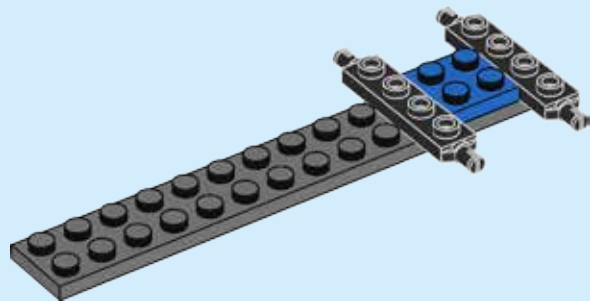

3

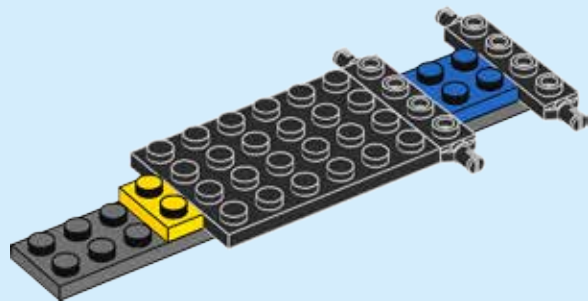



1x



2x

4

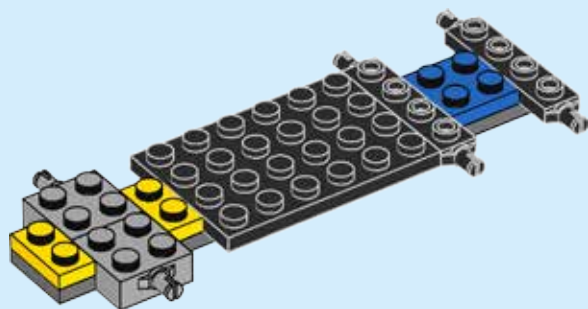

6

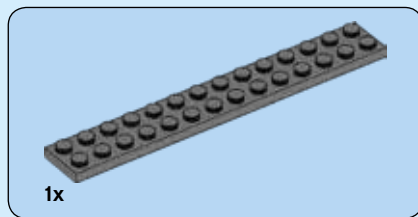

5

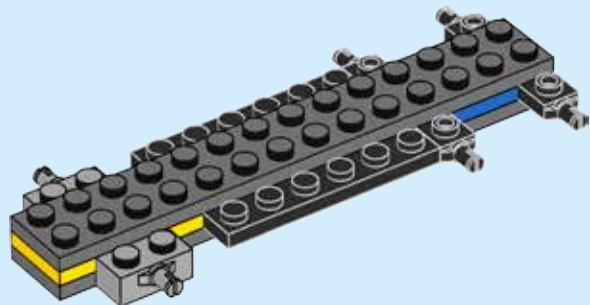

6

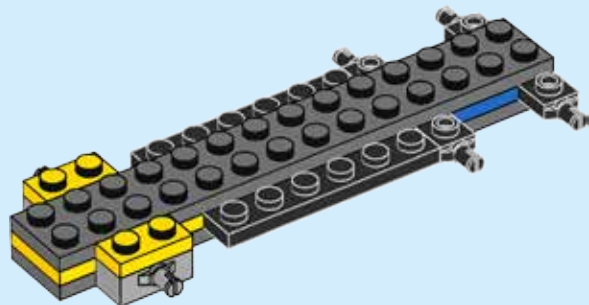



1x



1x

7

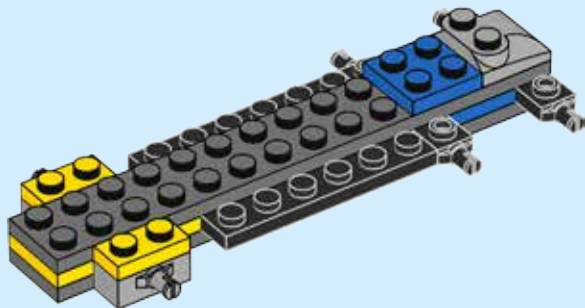

8



8

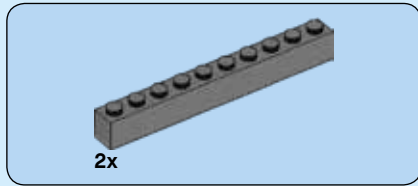
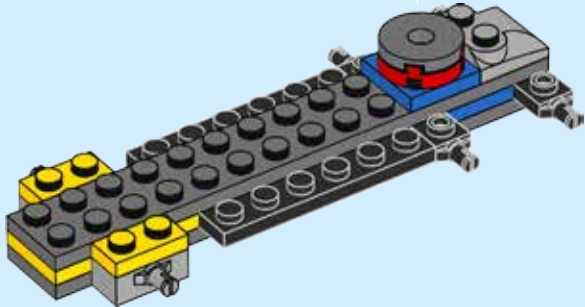

9

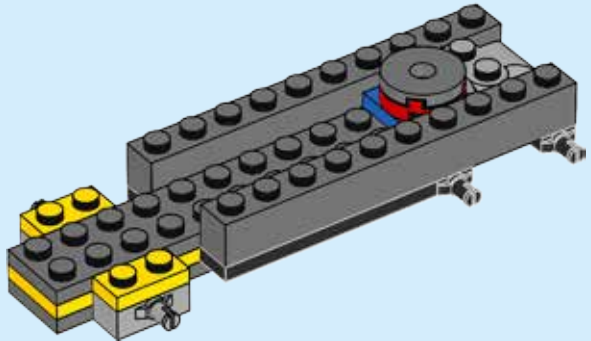

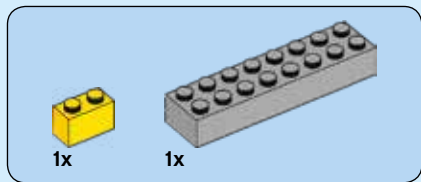

10

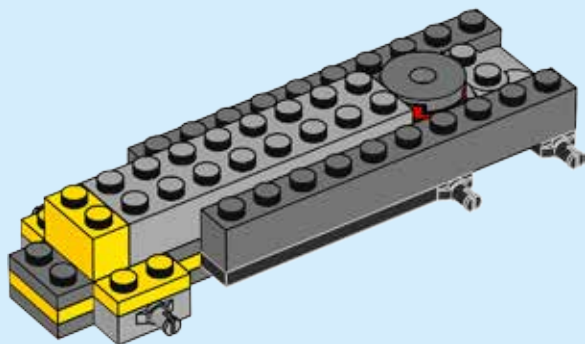



1x

11

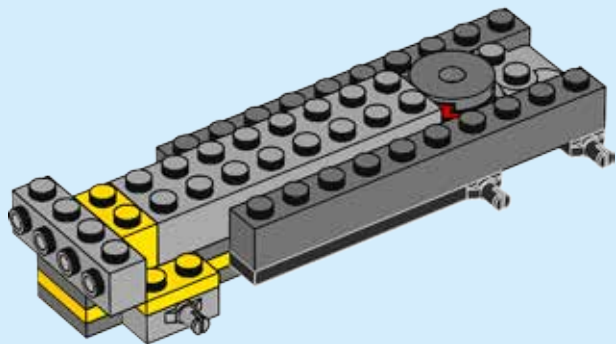

4x

12



4x

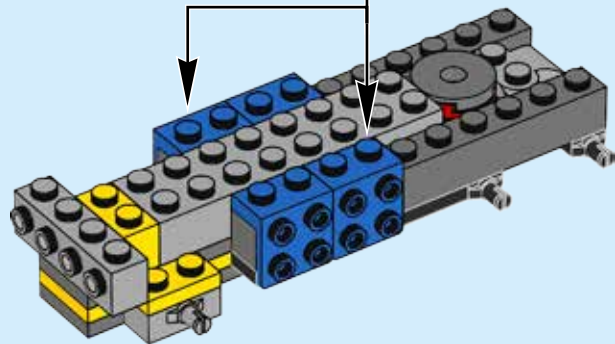

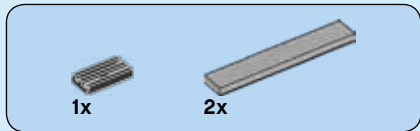

13

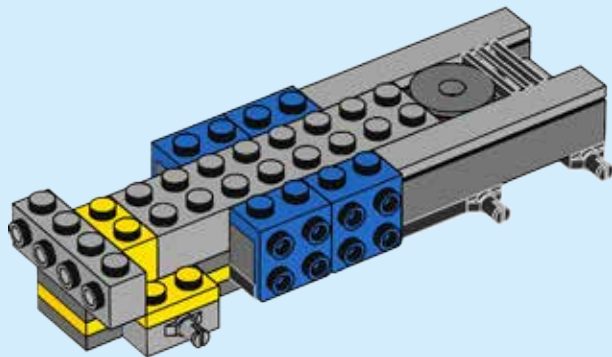



1x



2x

14

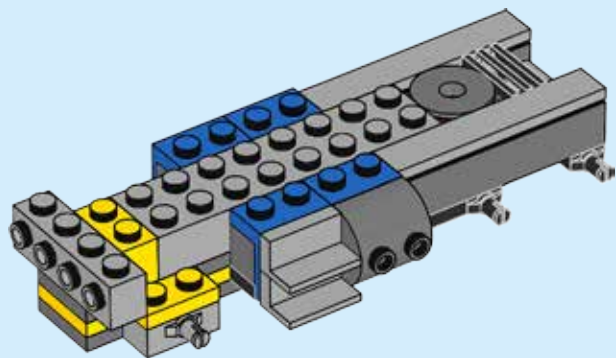

1x



2x

15

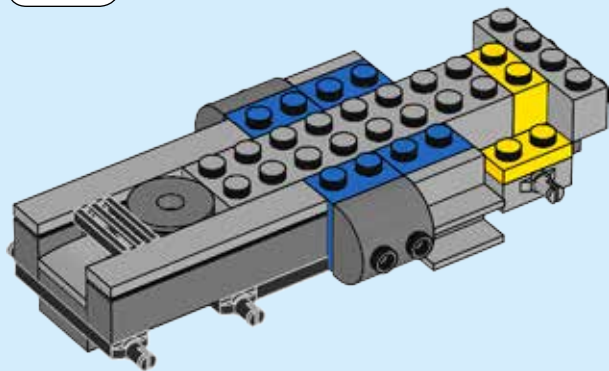
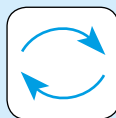



16

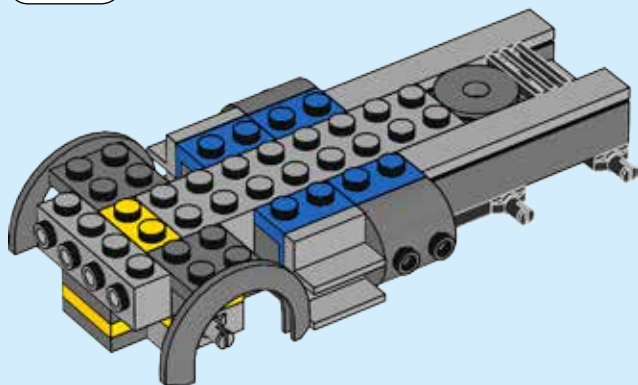
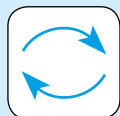

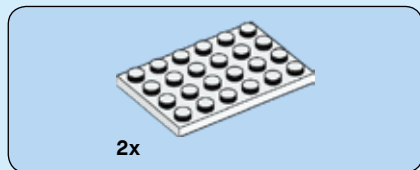

17

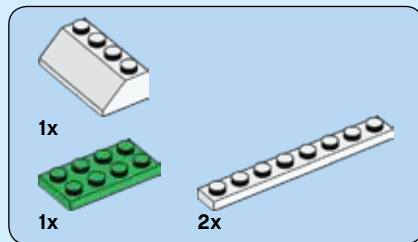
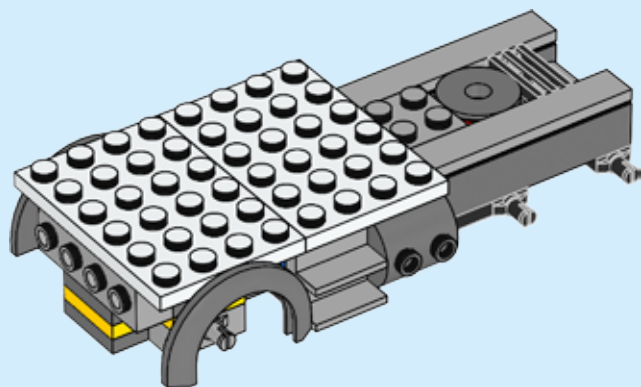

18

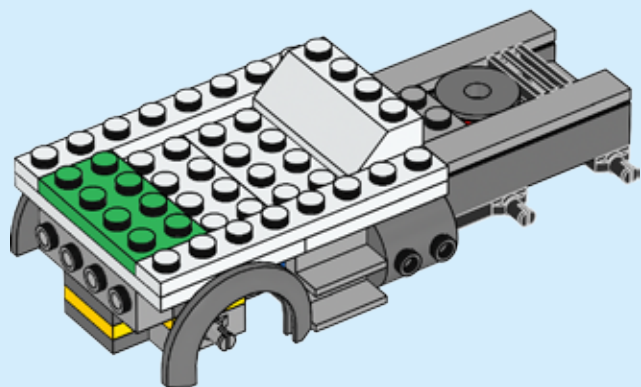



2x



1x



1x

19

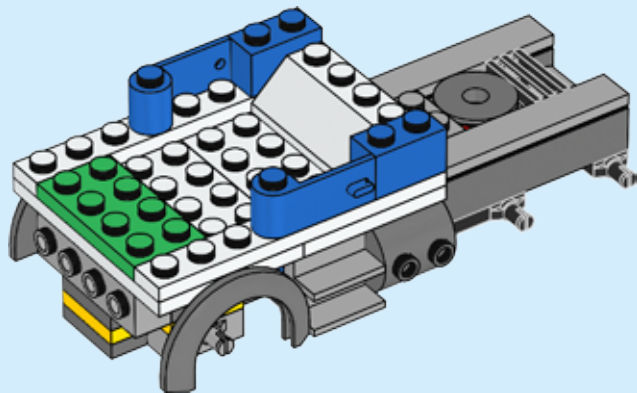

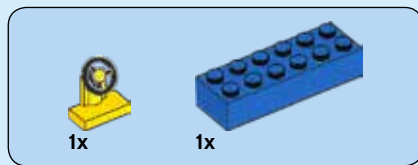

20

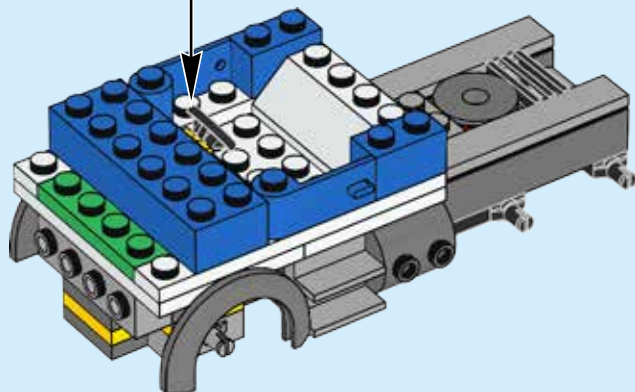

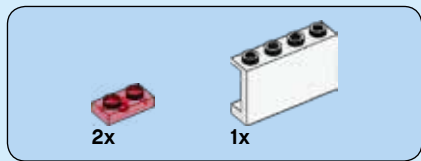

21

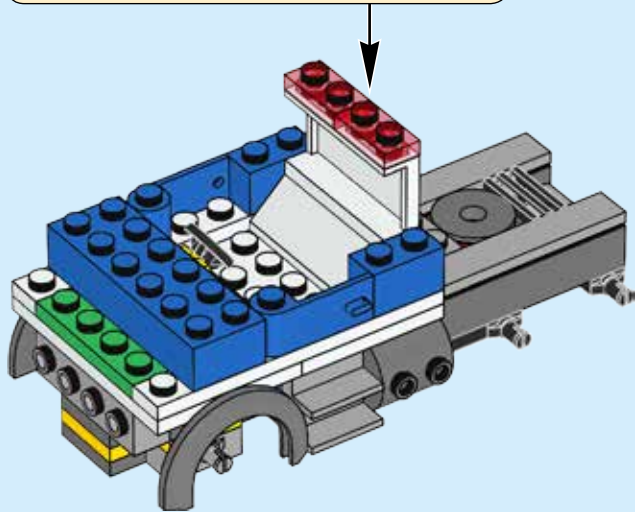
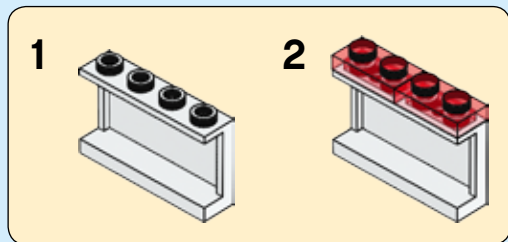

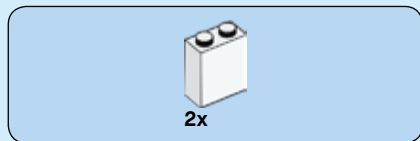

22

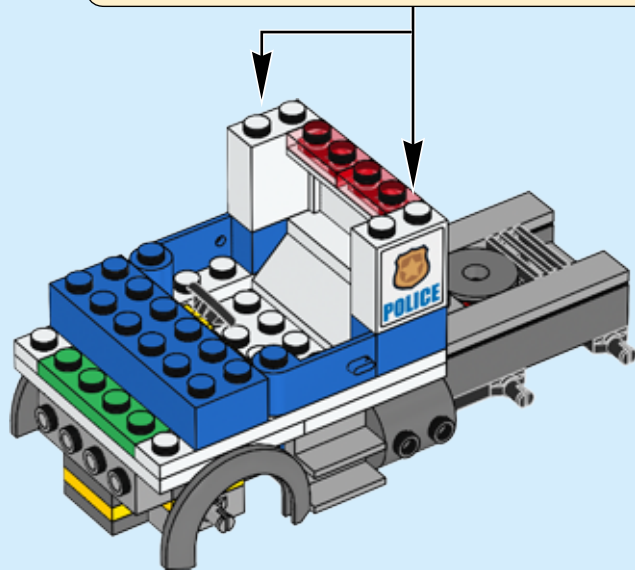

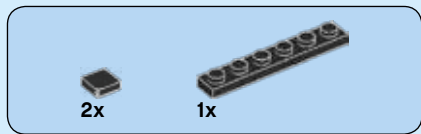

23

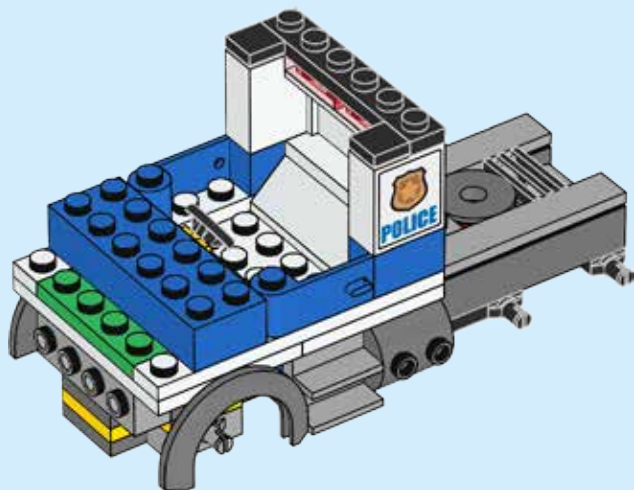

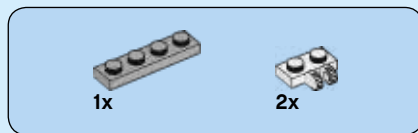

24

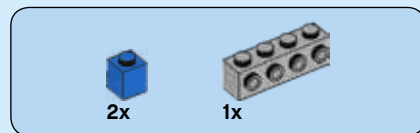
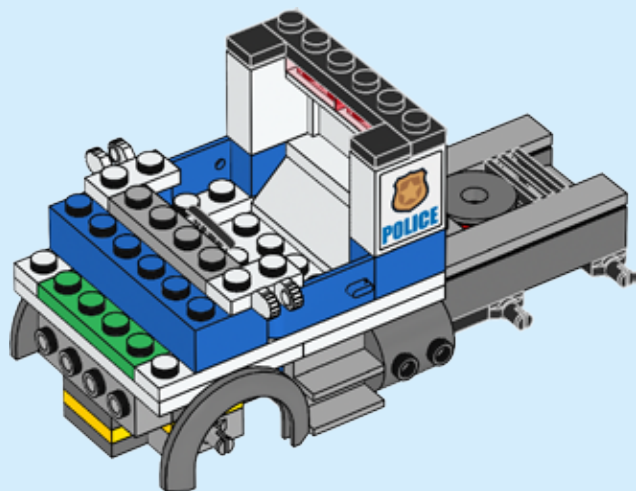

25

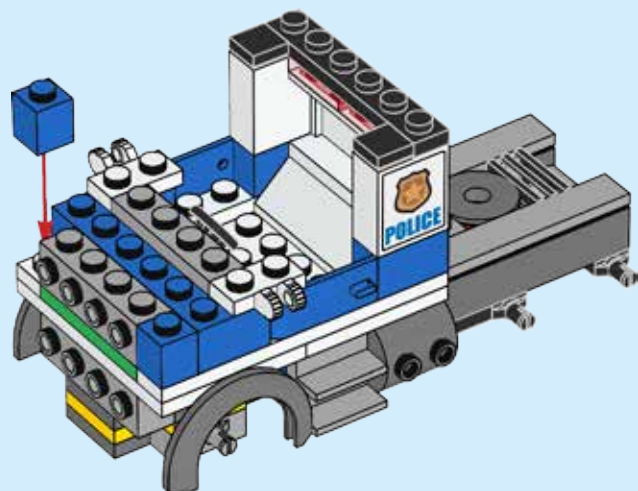

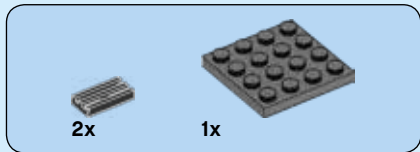

26

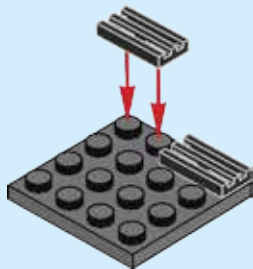

27

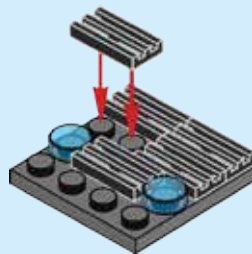



1x



2x

28

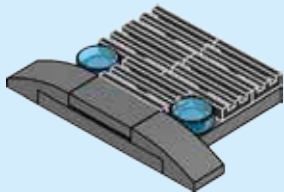

1x

29

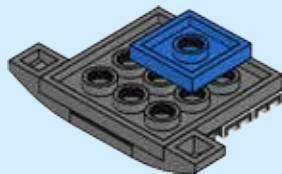
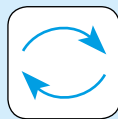



2x

30



2x

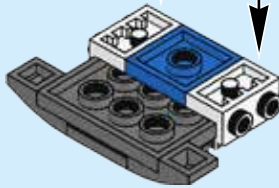

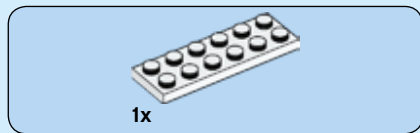

31

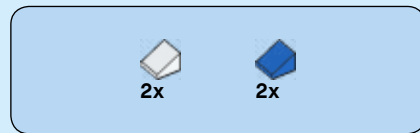
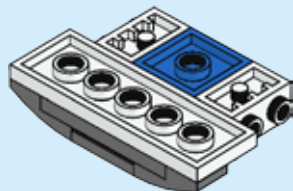

32

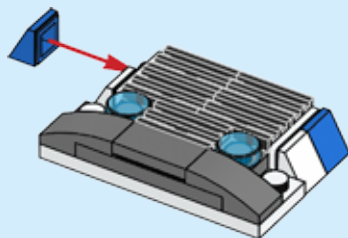
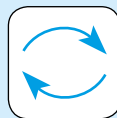



2x

33

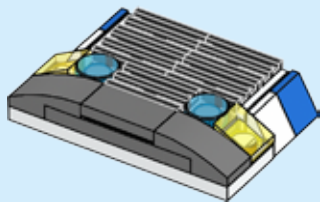

34

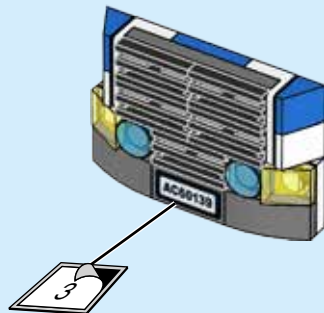
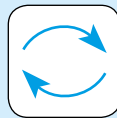

35

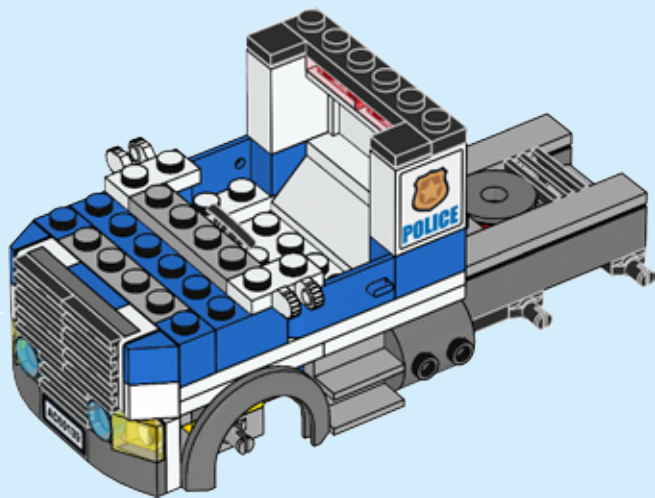



1x



1x



1x

36

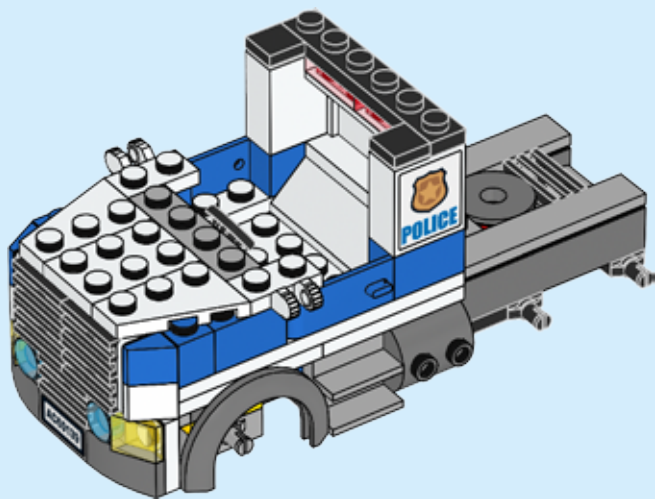



1x

37

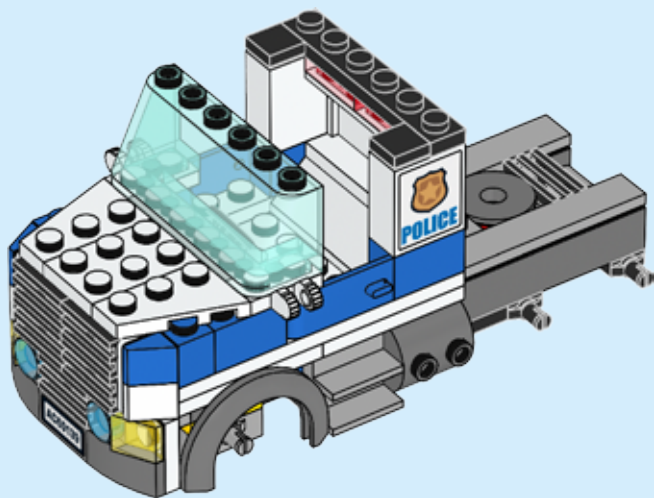

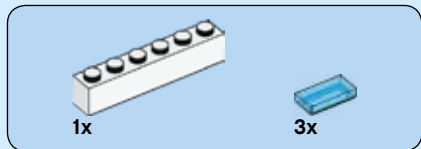

38

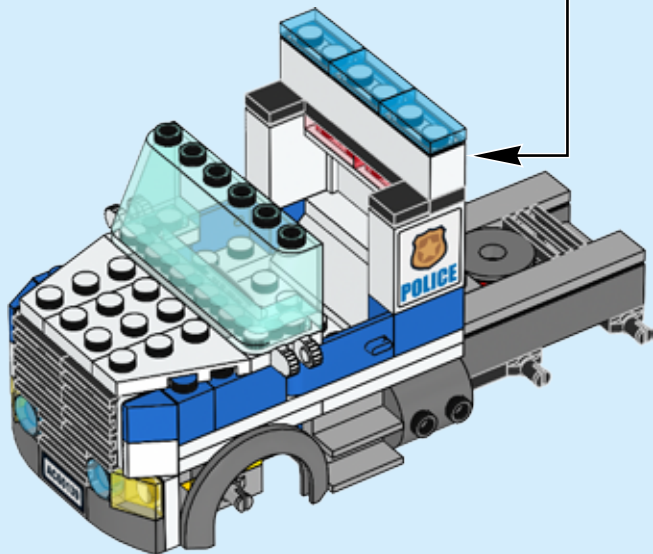
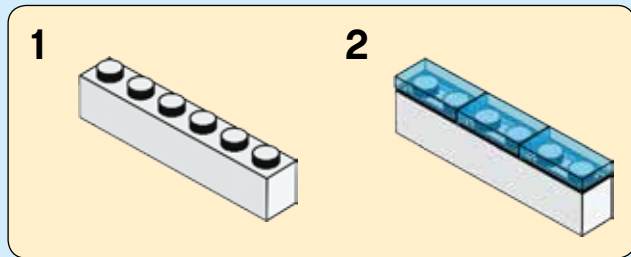

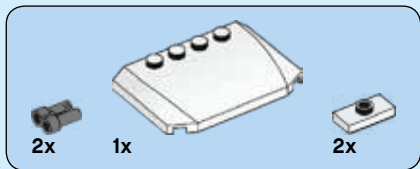

39

1

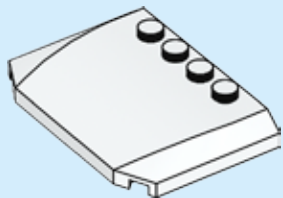

2

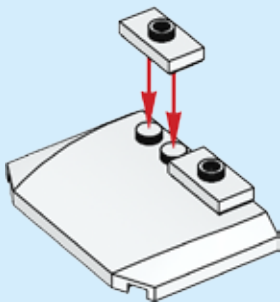

3

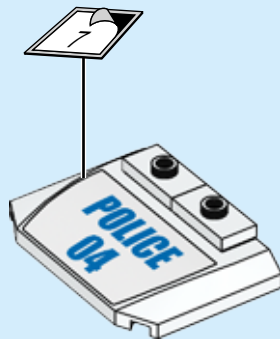

4

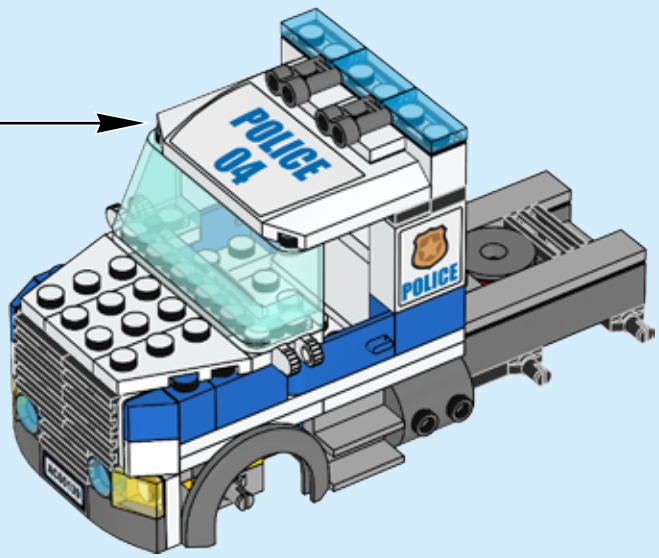
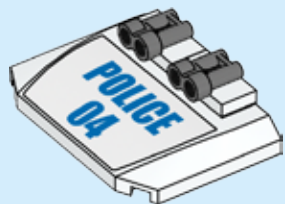



2x



2x

40

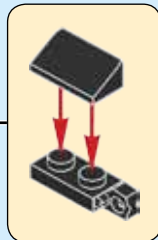
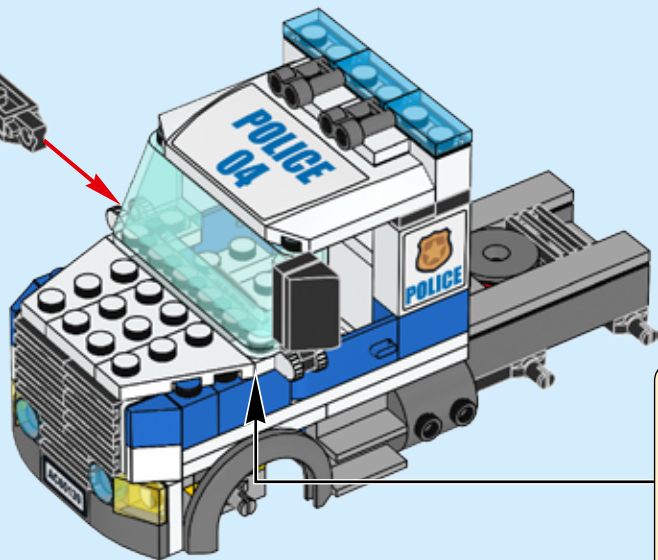
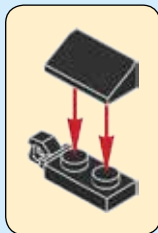

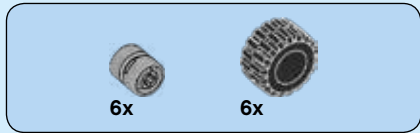

41

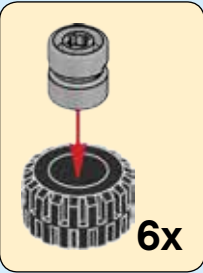

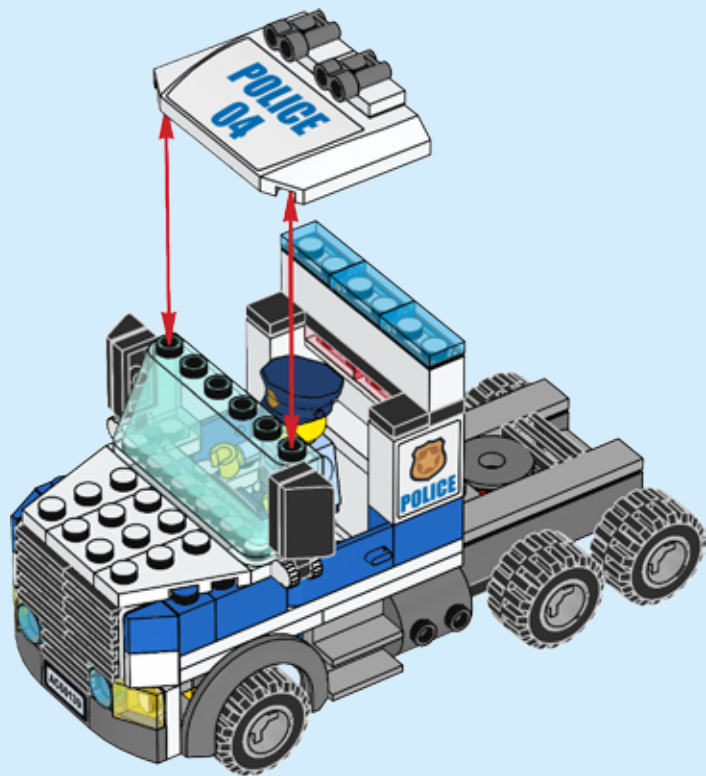



2x
4518400



2x
4504369



1x
245301



1x
302401



2x
6055541



2x
300501



1x
4298609



1x
4179874



1x
4179875



2x
4515337



3x
6051511



2x
6057414



1x
4293350



6x
4113261



3x
245401



2x
4611700



2x
6070698



1x
6126046



2x
6047220



9x
6013866



2x
6004491



2x
300301



2x
366001



1x
390001



1x
4109791



3x
362301



2x
4568956



1x
302101



2x
243101



1x
6079140



2x
4541956



1x
303701



1x
663601



1x
300901



5x
4504228



3x
6030965



2x
6058182



3x
379501



1x
6167823



1x
4261565



2x
346001



1x
4163986



2x
303201



1x
4501853



2x
4144012











































































1x
303601



1x
4514842



1x
4598523

 1x 389921	 2x 300423	 2x 371023	 1x 6021844	 1x 6179311	 1x 9339	 14x 4568644	 3x 6012983
 2x 4651524	 4x 6092582	 1x 4181139	 1x 6176636	 1x 73737	 2x 4598528	 1x 6053077	 1x 366626
 1x 403221	 4x 6117968	 2x 346023	 4x 302324	 1x 6164379	 1x 243226	 3x 4515368	 2x 4243819
 1x 241221	 1x 4586547	 4x 300823	 1x 300424	 2x 6139403	 6x 241226	 1x 400626	 1x 379526
 1x 6023770	 6x 302223	 1x 303423	 1x 9553	 1x 6100054	 1x 6020193	 1x 300226	 1x 6104030
 2x 4653024	 1x 4586544	 1x 303423	 1x 407924	 2x 6055630	 2x 6055630	 1x 3004326	 1x 6104030
 1x 4561034	 2x 362223	 3x 303523	 1x 6176441	 2x 307026	 2x 6064174	 2x 615726	 1x 303226
 2x 4504380	 2x 300223	 1x 6057836	 1x 6172536	 1x 4157108	 2x 4183043	 2x 302026	 1x 244526
 2x 300523	 2x 300223	 1x 6176018	 1x 6176513	 2x 4548180	 1x 368026	 4x 292626	
 2x 4570283	 2x 243123						



2x
4295260



1x
302028



1x
6115306



2x
4646864



2x
4201019

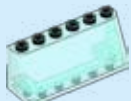

1x
4287016



11x
4646861



1x
4260426



3x
4113854



2x
4650500



2x
4260942



1x
4163306



4x
4646865



1x
4598955



1x
6055889



2x
4162916



1x
4614195



2x
4211483



2x
4590443



2x
4533772



14x
4211764



6x
4278273



1x
4540203



1x
4211350



1x
4226995



4x
4211515



1x
4211388



1x
4654582



1x
4641048



8x
4244627



5x
4535738



2x
6018081



1x
4211397



1x
4494475



2x
4211398



2x
6089147



2x
4211429



1x
4211396



2x
4610149



2x
4211636



2x
4211445



2x
6028811



2x
4211549



2x
4211425



1x
4211406



1x
4289542



2x
4211051



2x
4579354



1x
6055313



1x
4222693



2x
4211052



2x
6029948



2x
4211065



1x
4210865

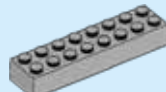

1x
6037399



1x
4611703



1x
4261908



1x
4212529



1x
4211060



2x
4211002



2x
4211107



3x
6000970



1x
4516456



2x
4211093



2x
4211055



2x
4260124



1x
4243831



Customer Service

Kundenservice

Service Consommateurs

Servicio Al Consumidor

LEGO.com/service or dial



00800 5346 5555 :

1-800-422-5346 :





WORLDS

UNLOCK MODEL IN GAME
 DÉBLOQUEZ LE MODÈLE EN JEU
 MODELL IM SPIEL FREISCHALTEN
 DESBLOQUEAR MAQUETA EN EL JUEGO
 DESBLOQUEAR MODELO NO JOGO
 MODELL KIOLDÁSA A JÁTÉKBAN
 在游戏里解锁模型

BG7DWK



CITY



7™

www.pegi.info

PROVISIONAL



LEGO.com/worlds

LEGO WORLDS software © 2017 TT Games Ltd. Produced by TT Games under license from the LEGO Group. LEGO, the LEGO logo, the Brick and the Knob configurations and the Minifigure are trademarks of the LEGO Group. © 2017 The LEGO group. All other trademarks and copyrights are the property of their respective owners. All rights reserved. WB GAMES LOGO, WB SHIELD:™ & © Warner Bros. Entertainment Inc. (s17)



CITY

UNDERCOVER

REMASTERED FOR 2017!

LEGO.com/videogames



www.pegi.info
PROVISIONAL

XBOX ONE PS4 Nintendo NX



© 2016 The LEGO Group.™ & © WBEI. (s16)

LEGO and the LEGO logo are trademarks of the LEGO Group.
©2017 The LEGO Group. 6188728



CITY

60139



LEGO.com/city



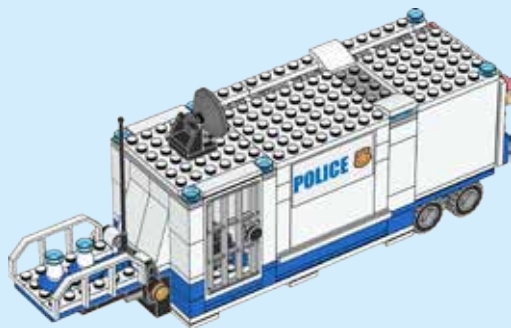
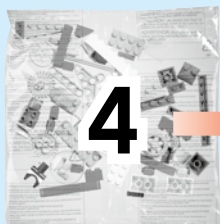
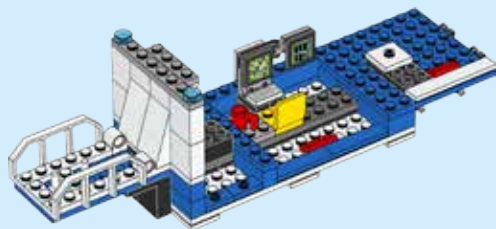
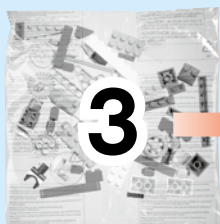

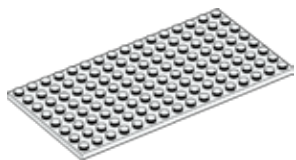

+

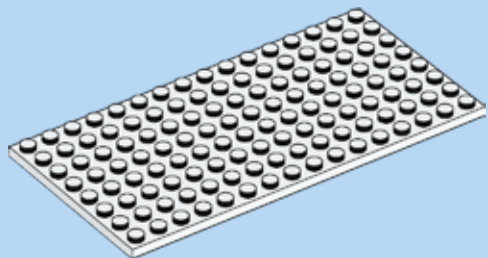
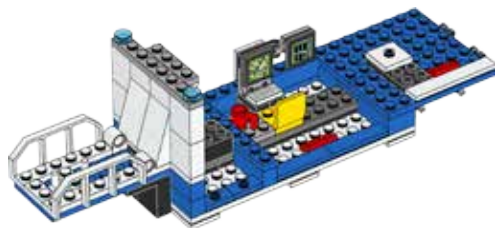
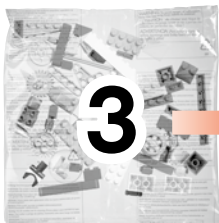

1x

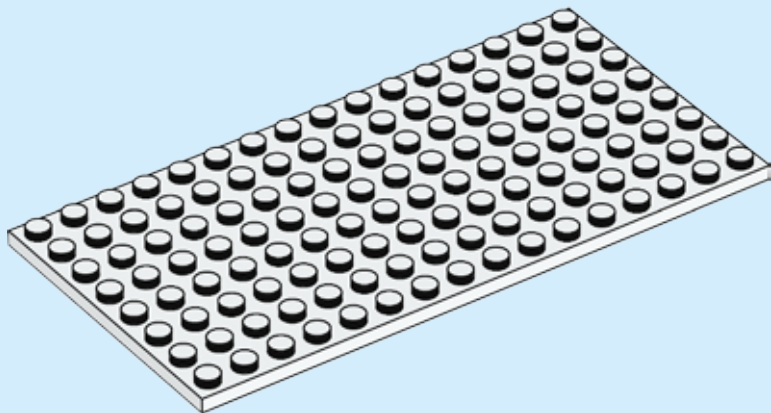

1



6x

2

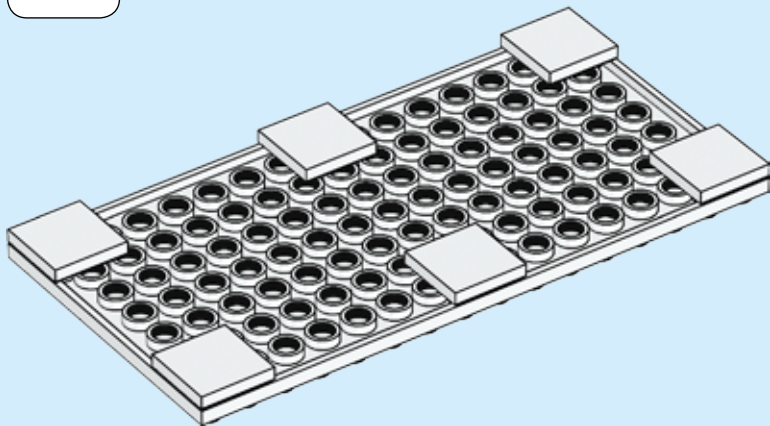
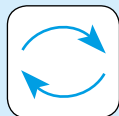

4

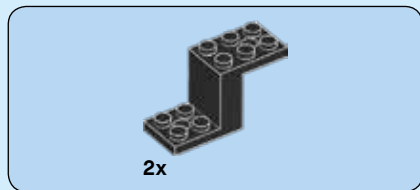

3

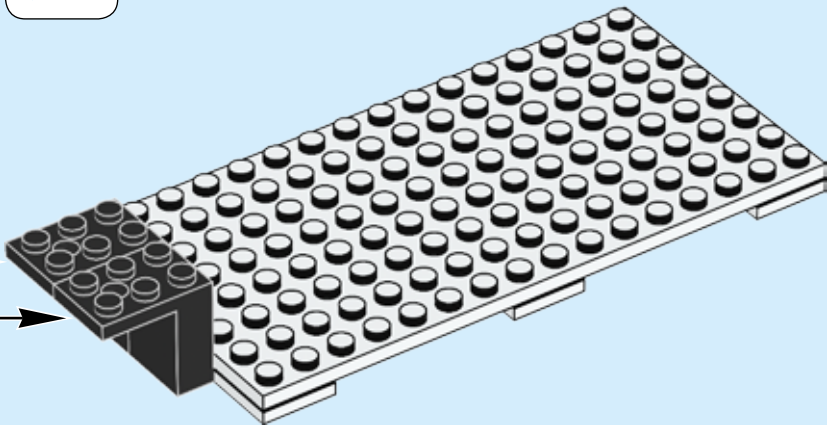
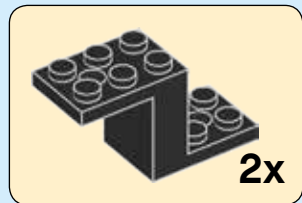
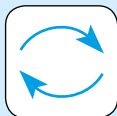

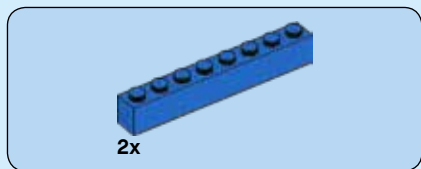

4

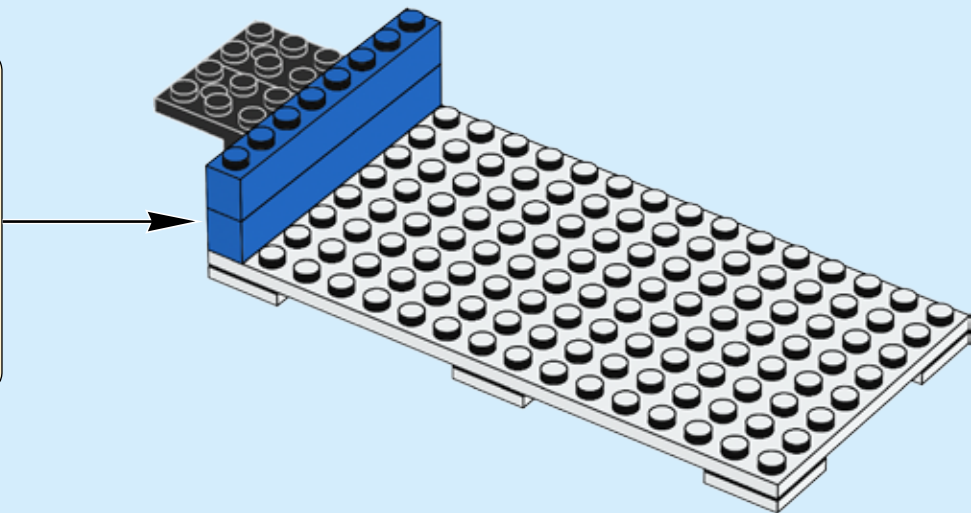
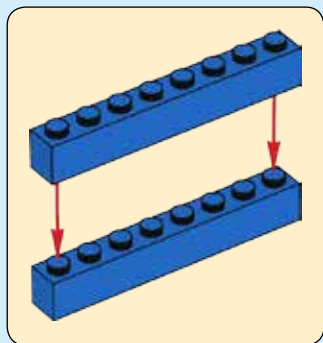



5

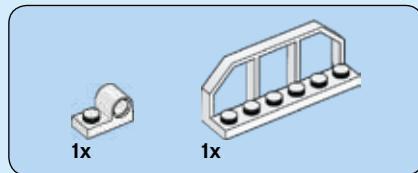
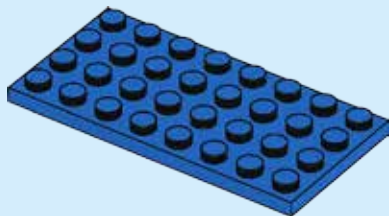

6

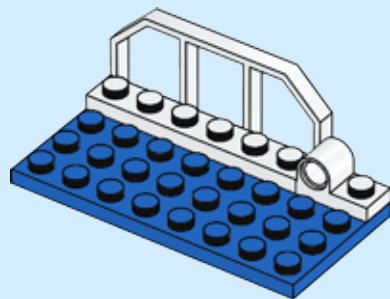



2x

7

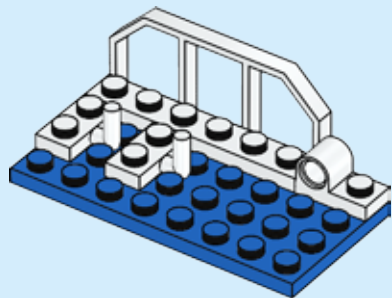

8



1x

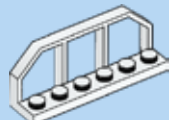

1x

8

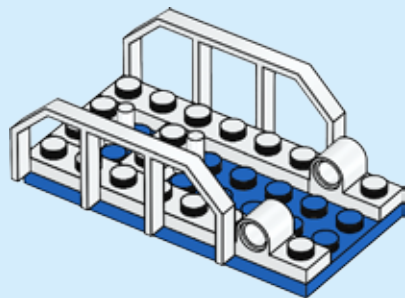

9

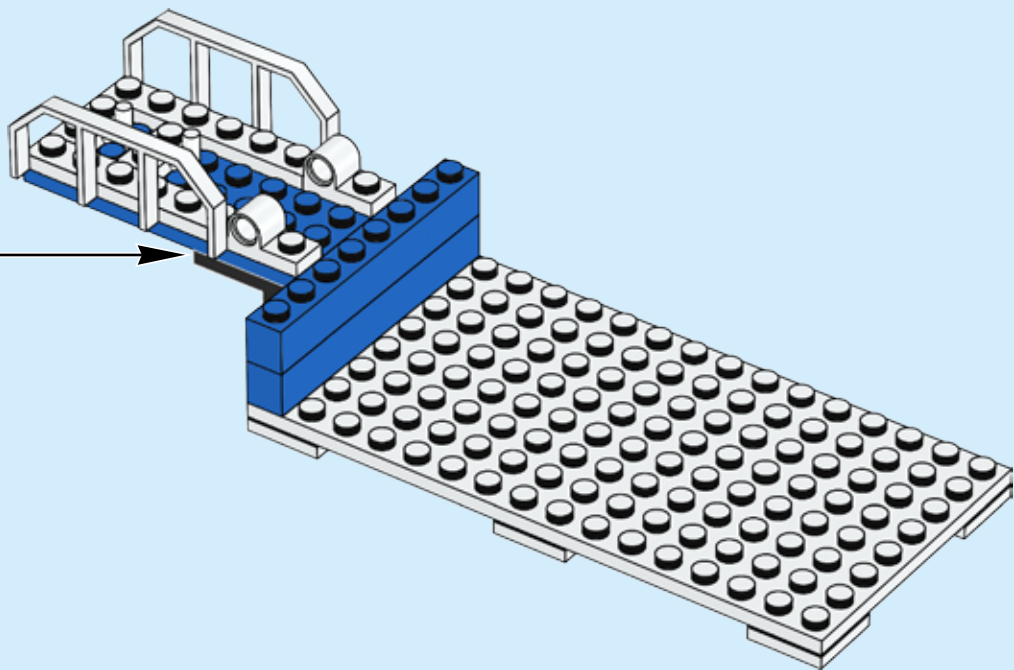

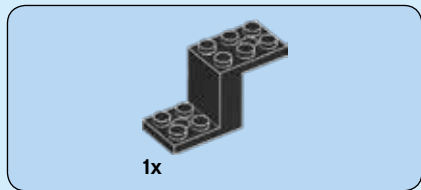

10

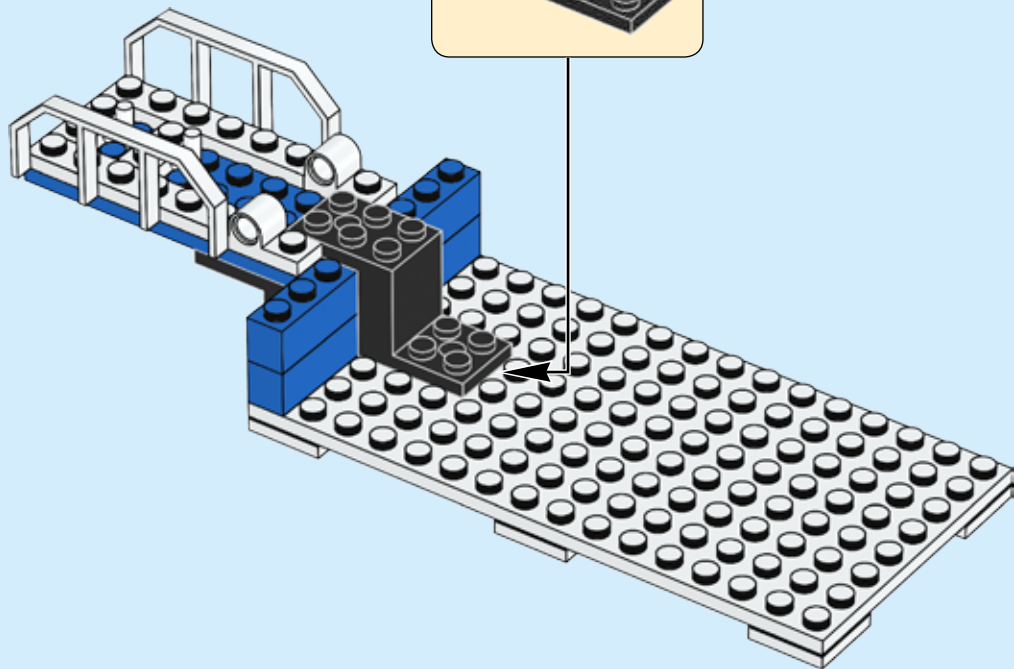
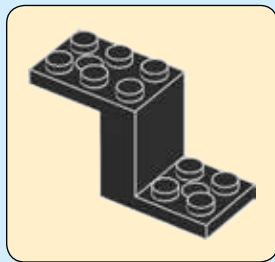



2x

11

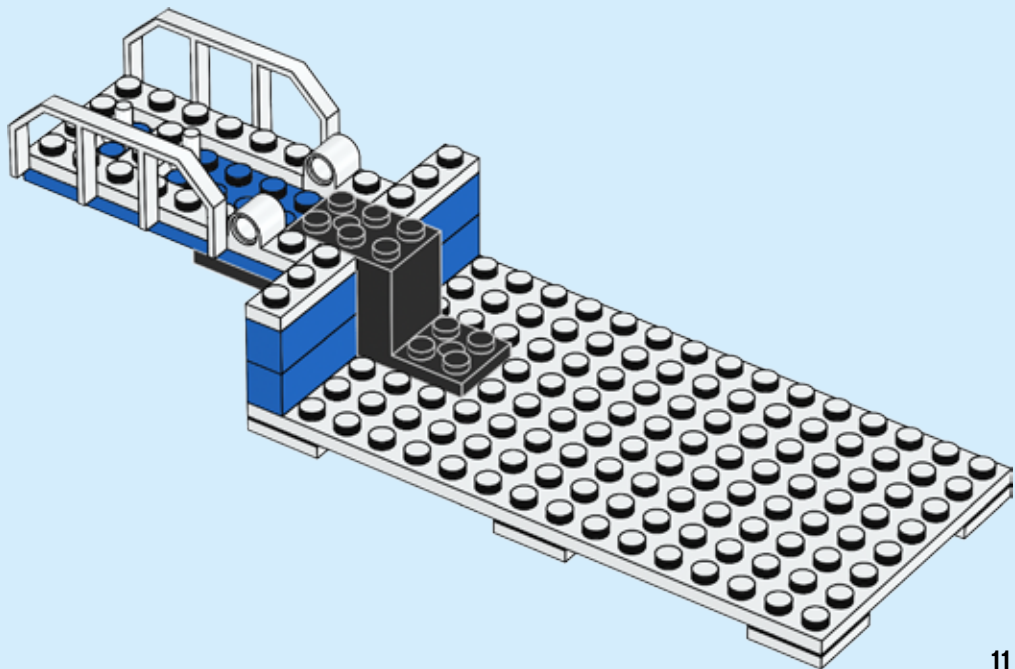

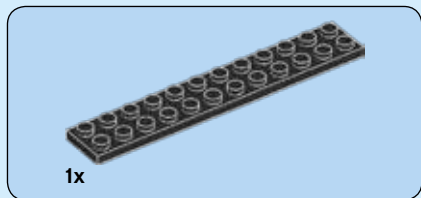

12

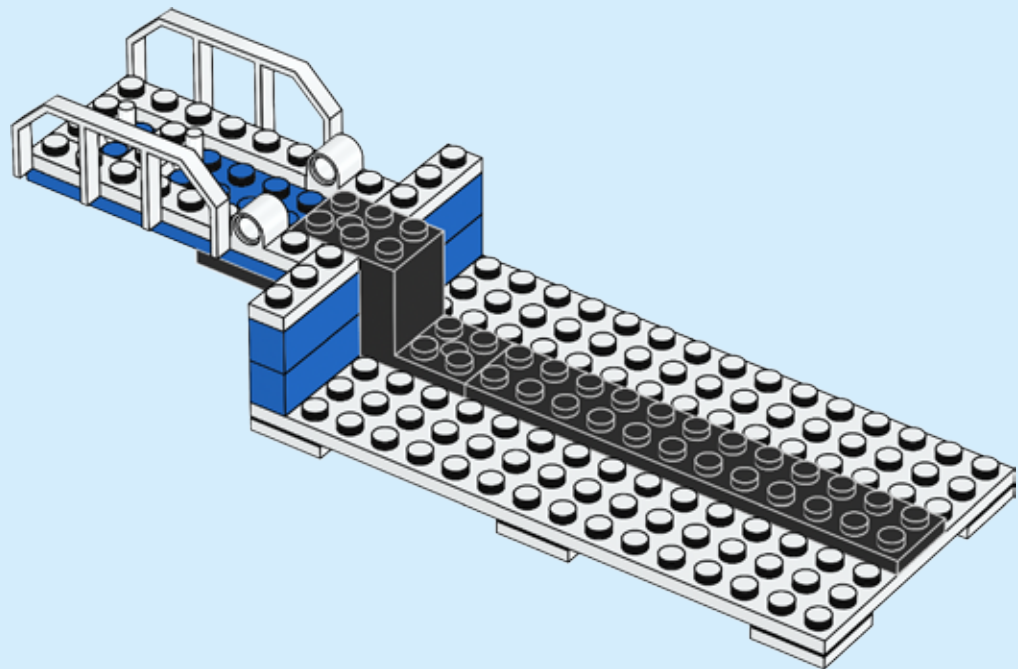

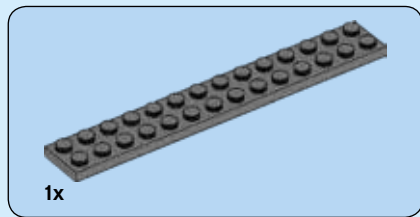

13

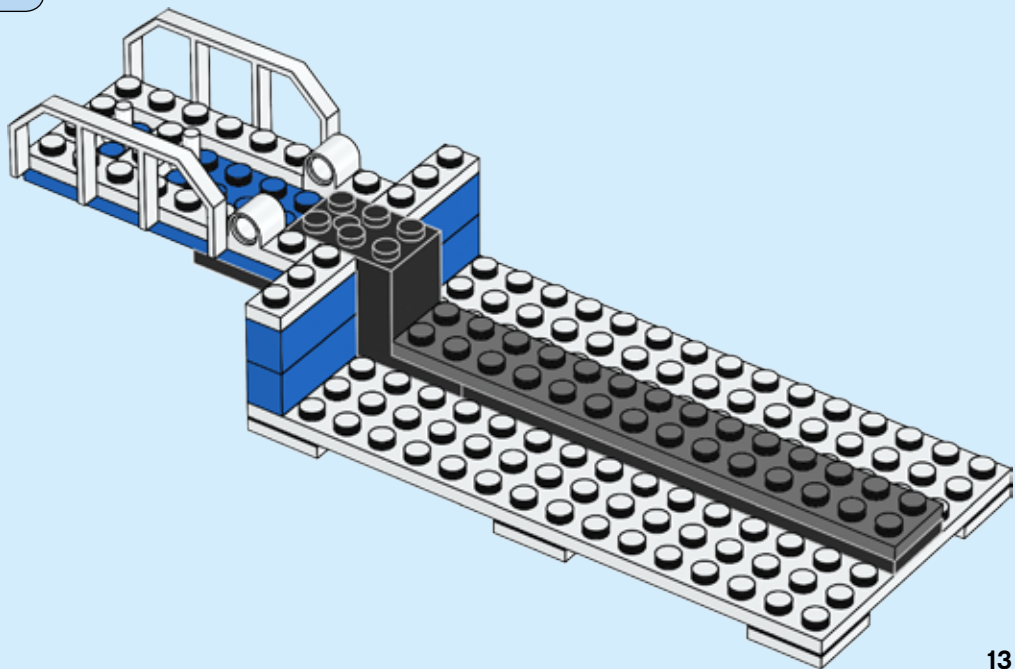



4x

14

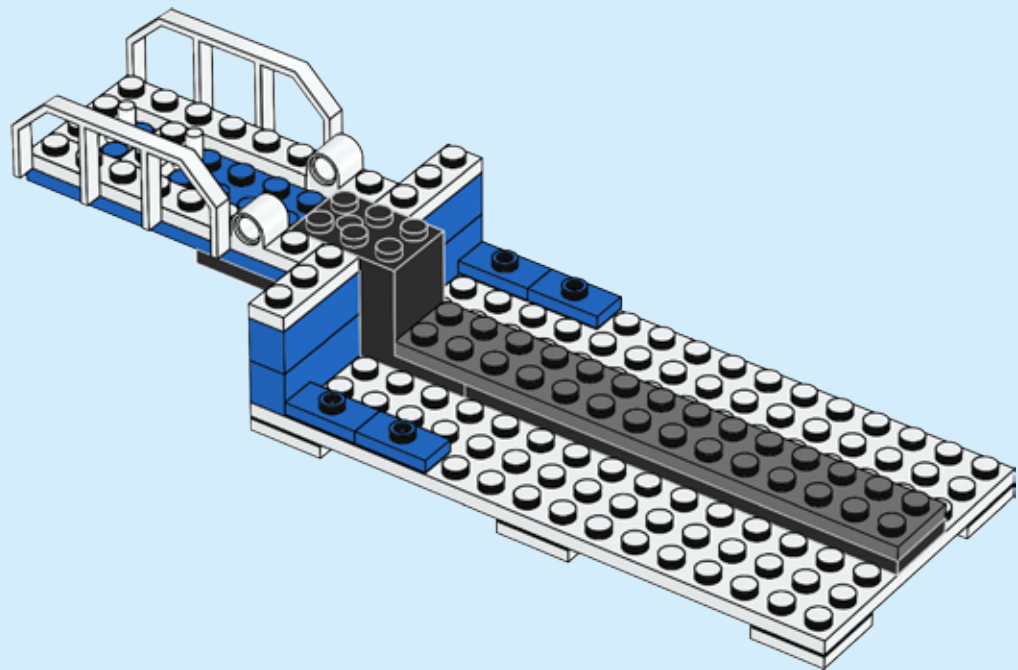

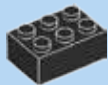

1x



1x

15

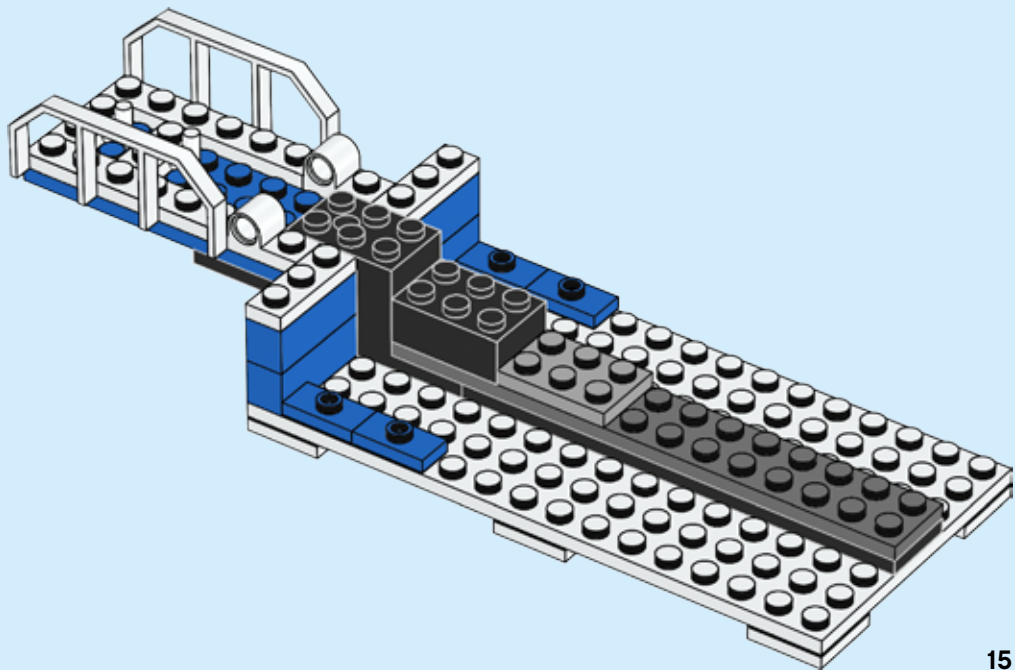



2x

16

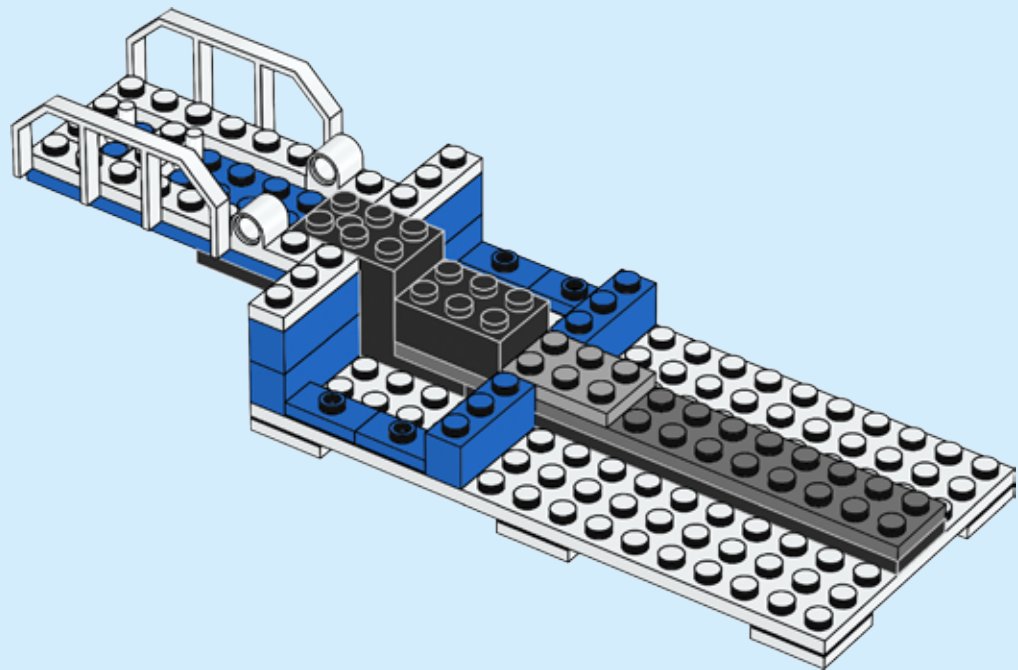

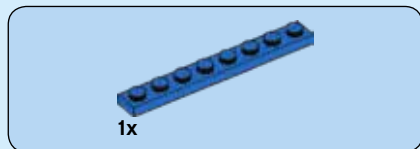

17

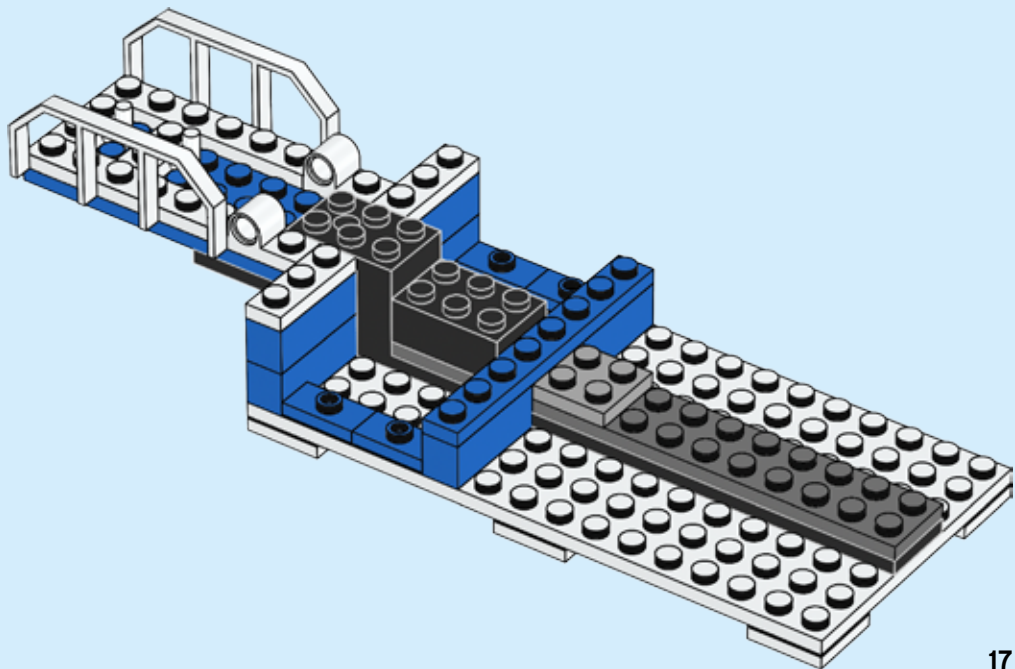

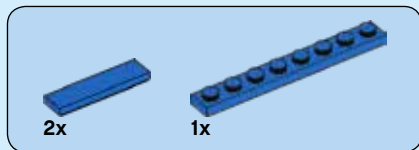

18

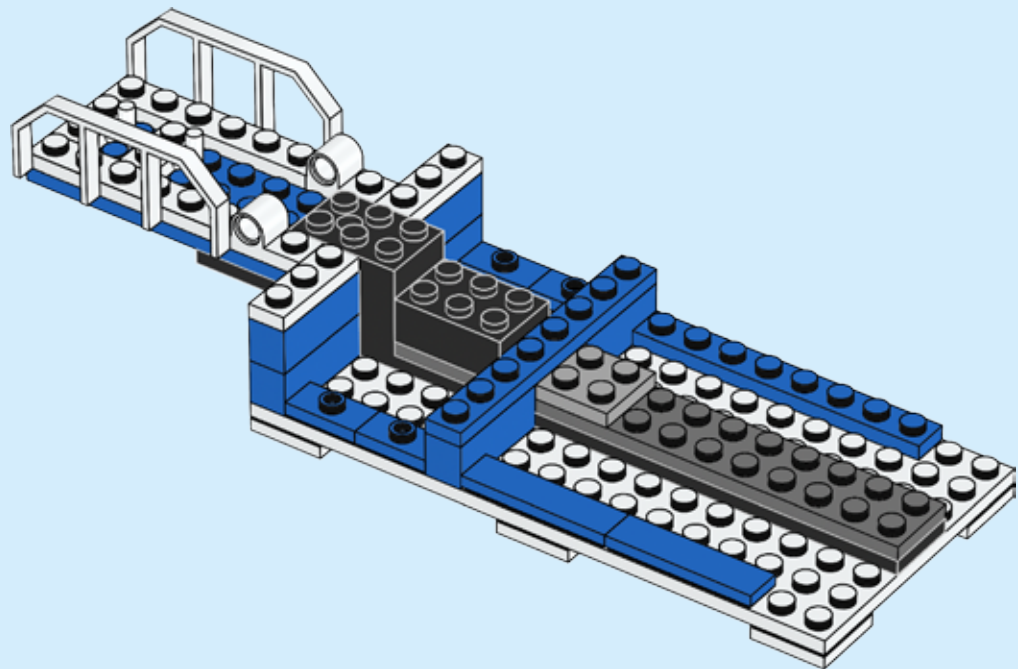

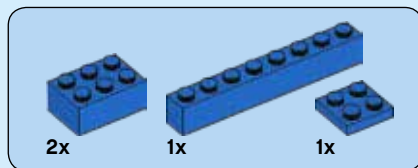

19

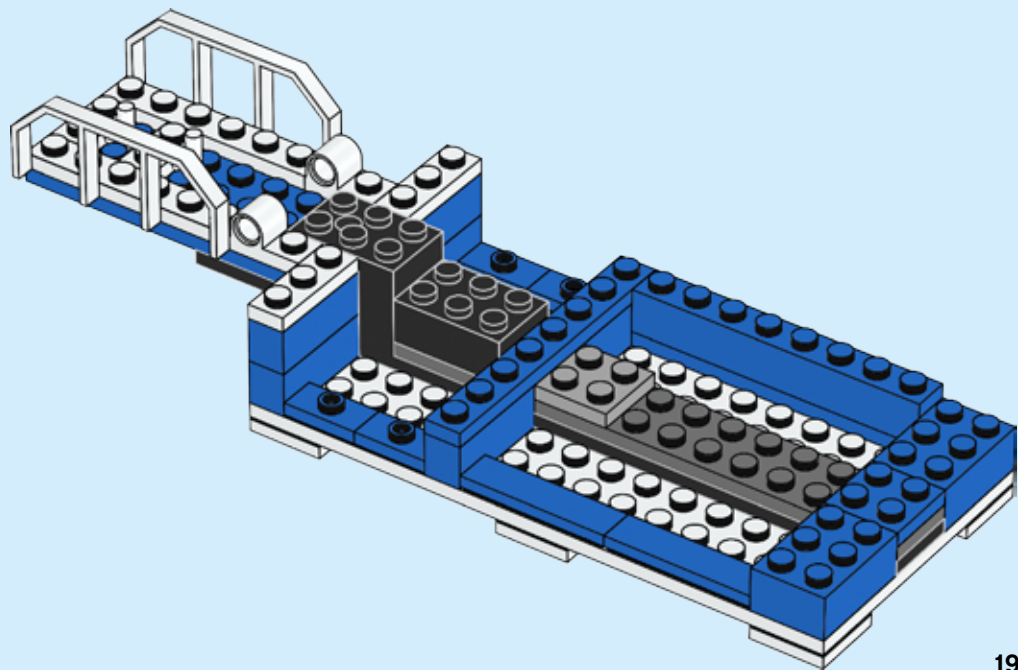

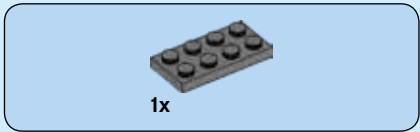

20

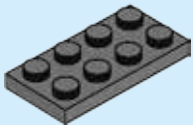

20



21

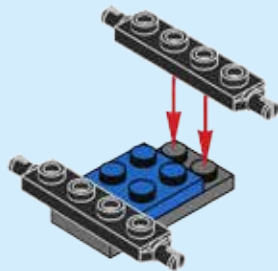

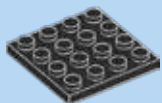

1x

22

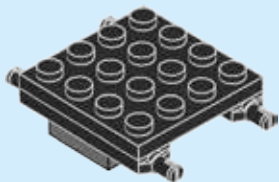

1x

23

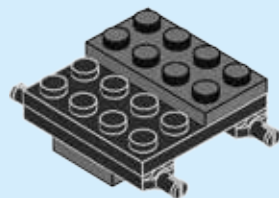

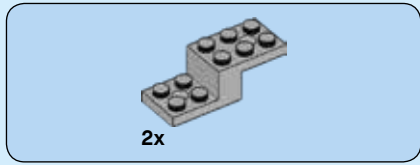

24

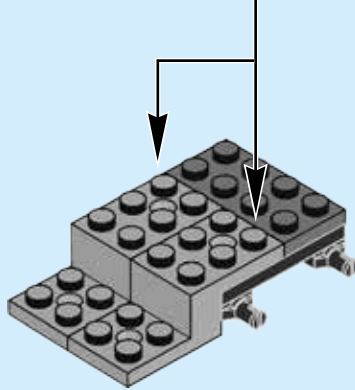
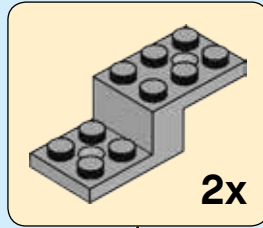



25

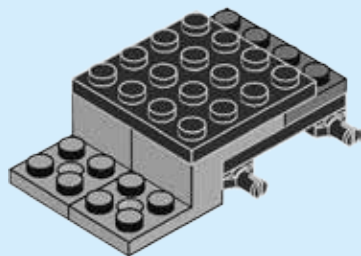

26

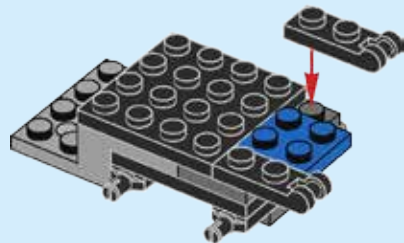

27

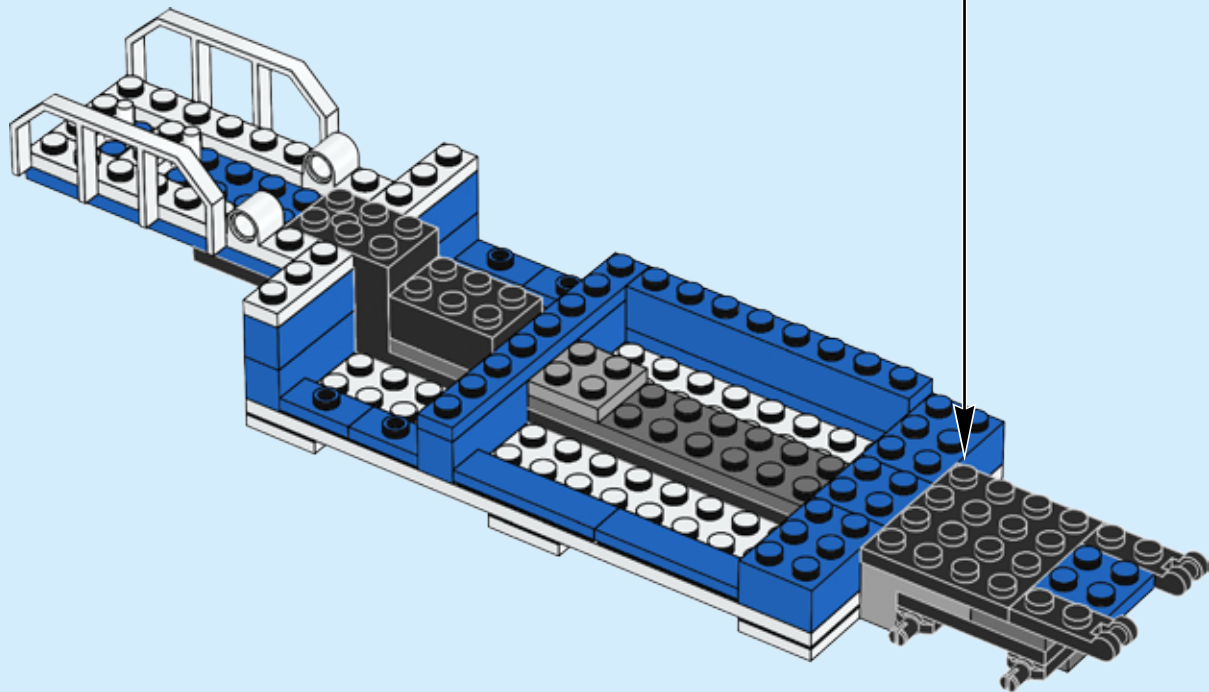



28

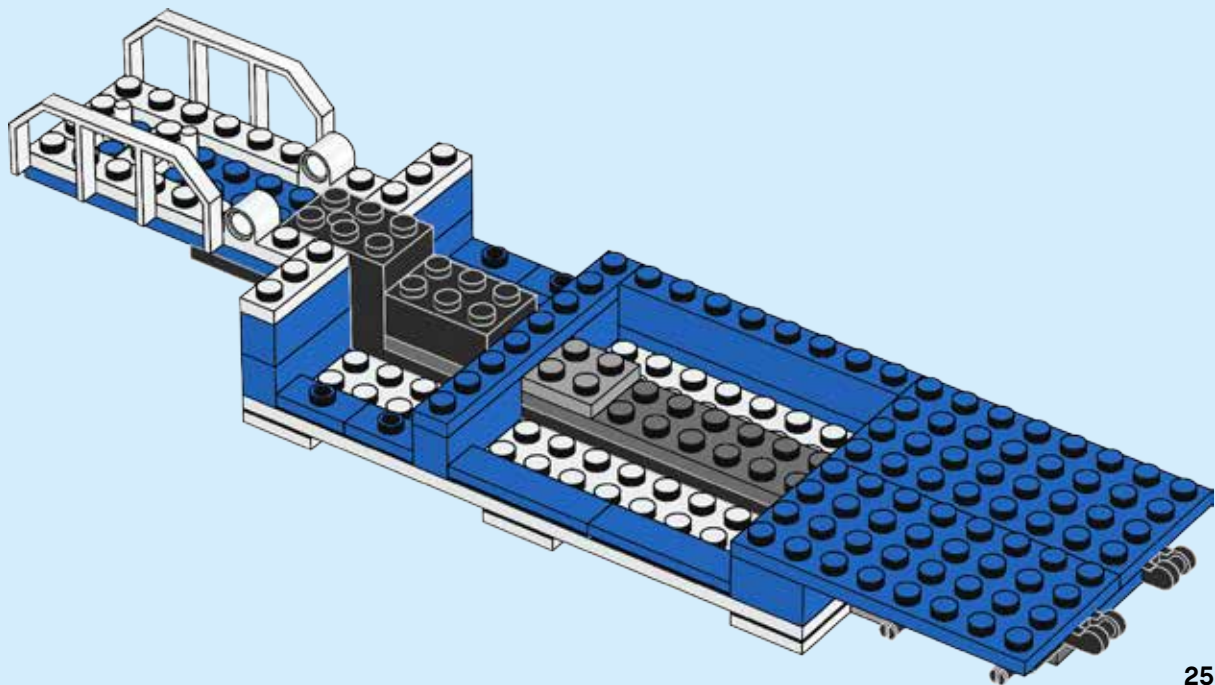



2x

29

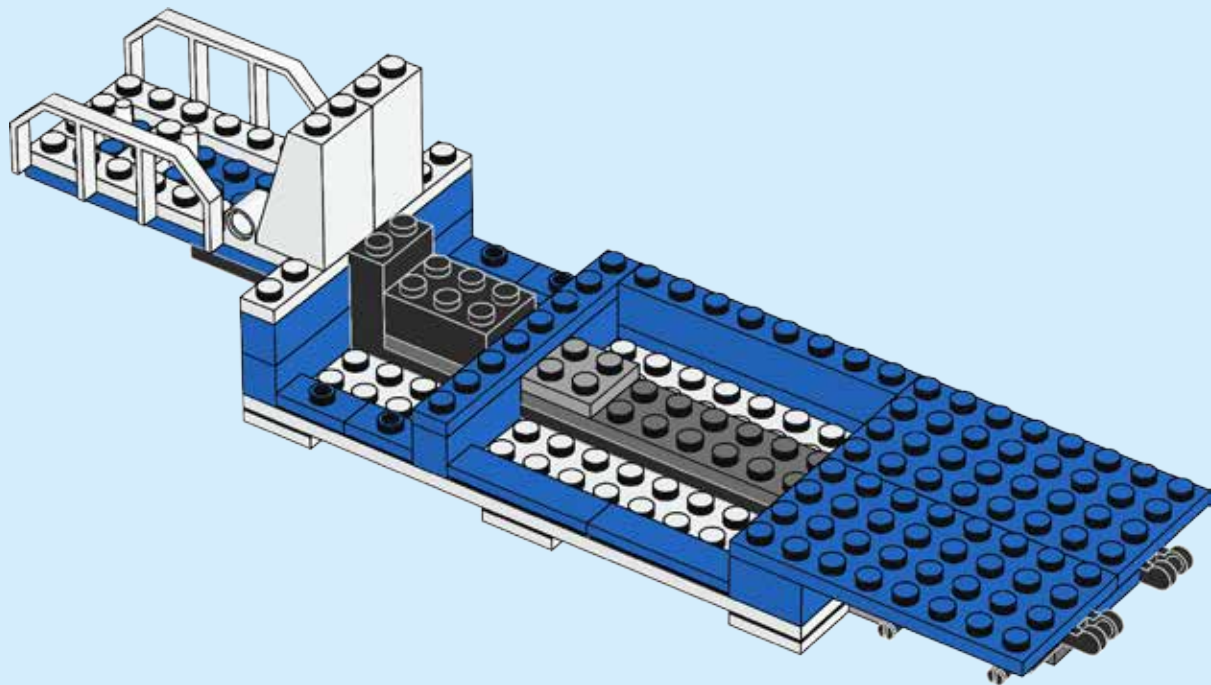

26



2x

30

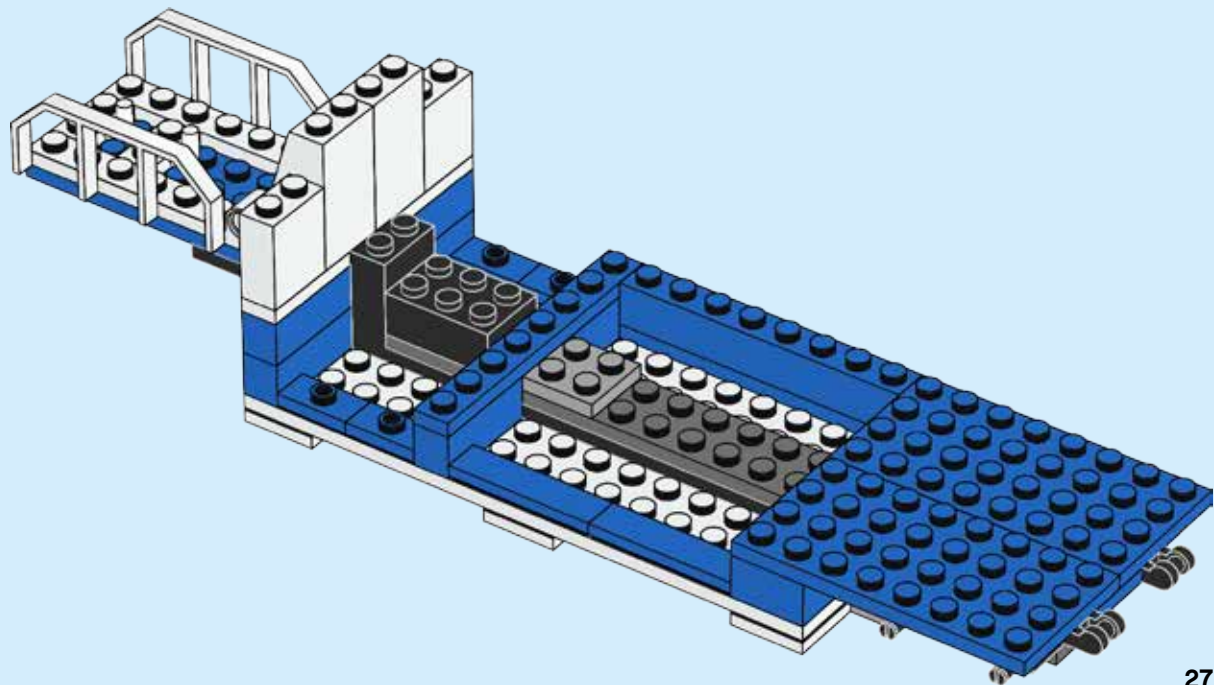



2x



2x

31

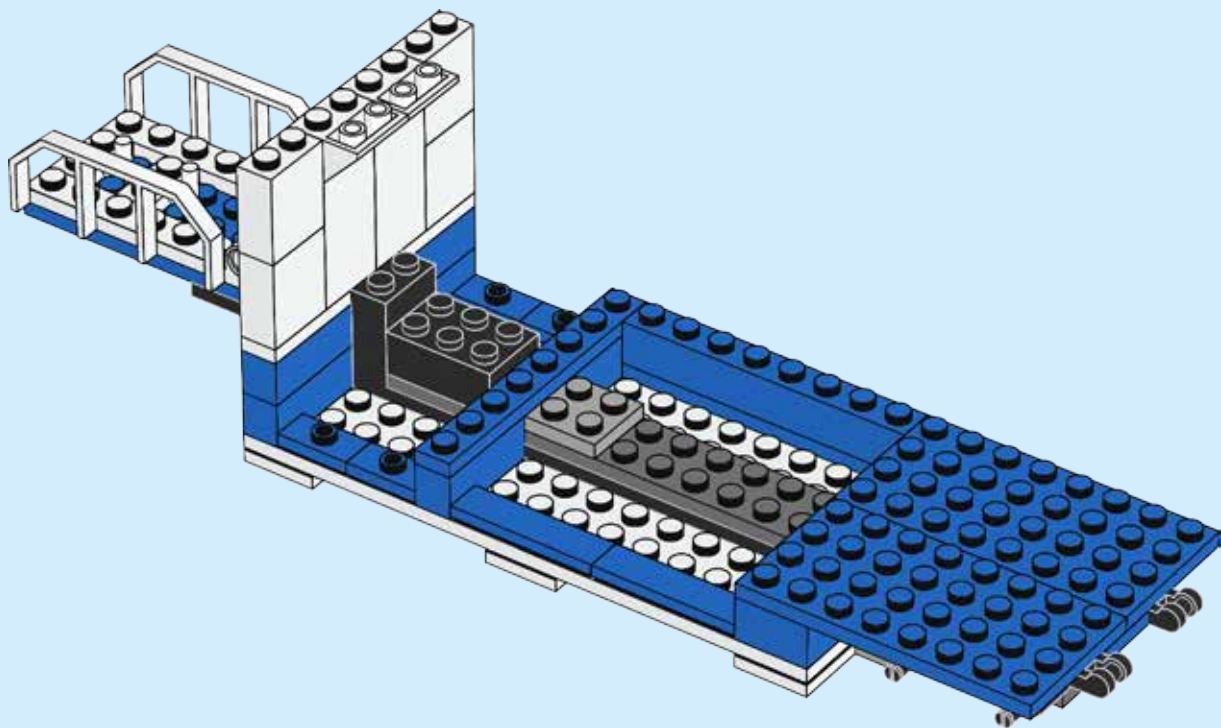

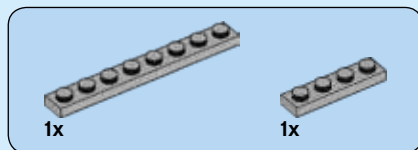

32

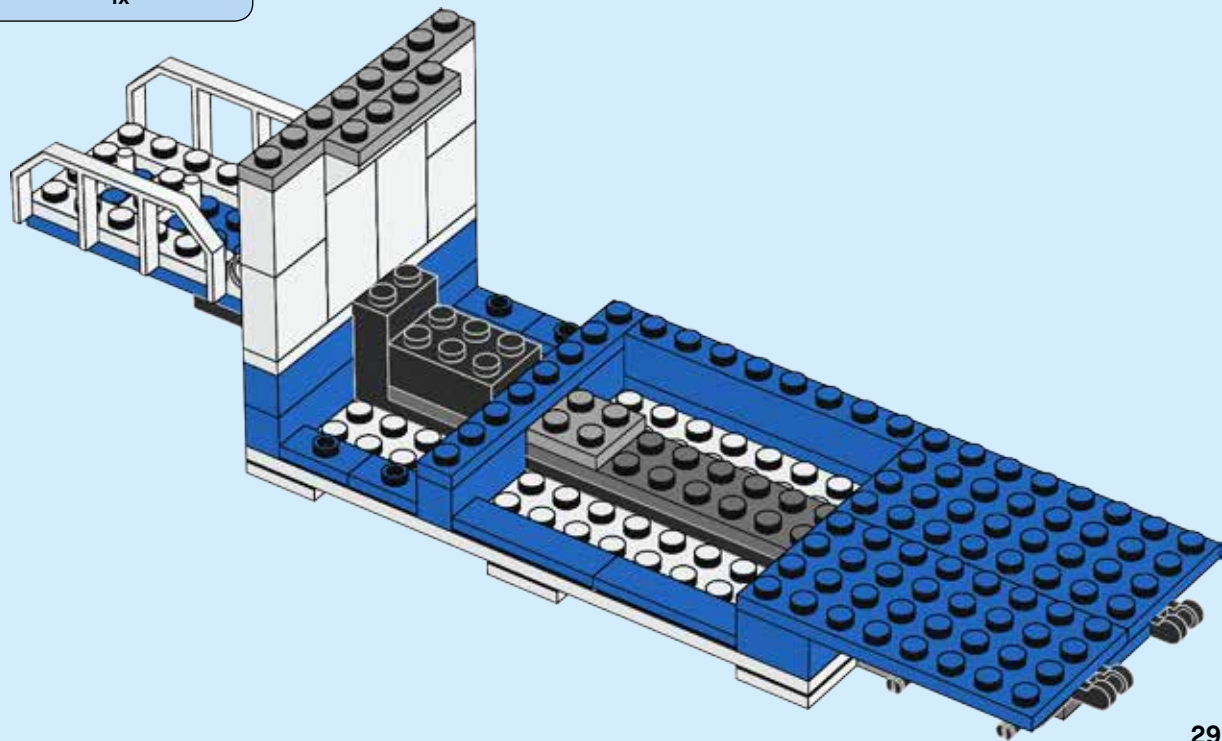



2x

33

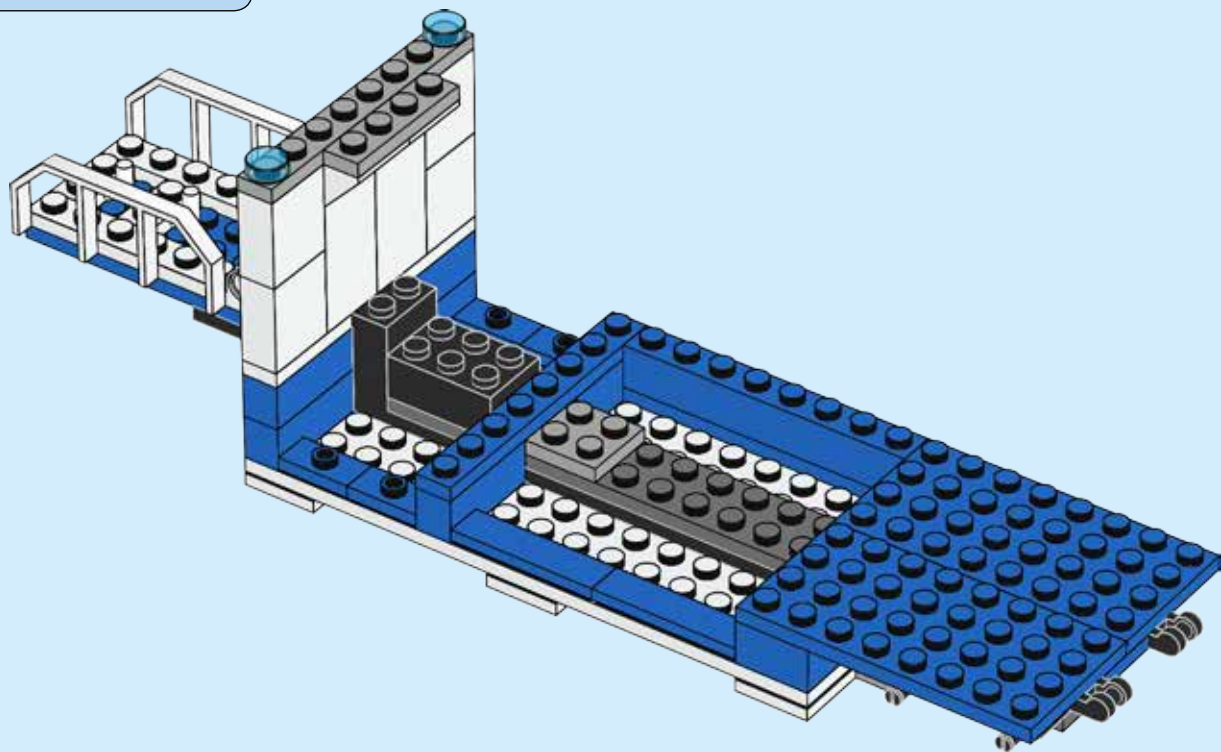

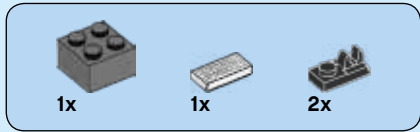

34

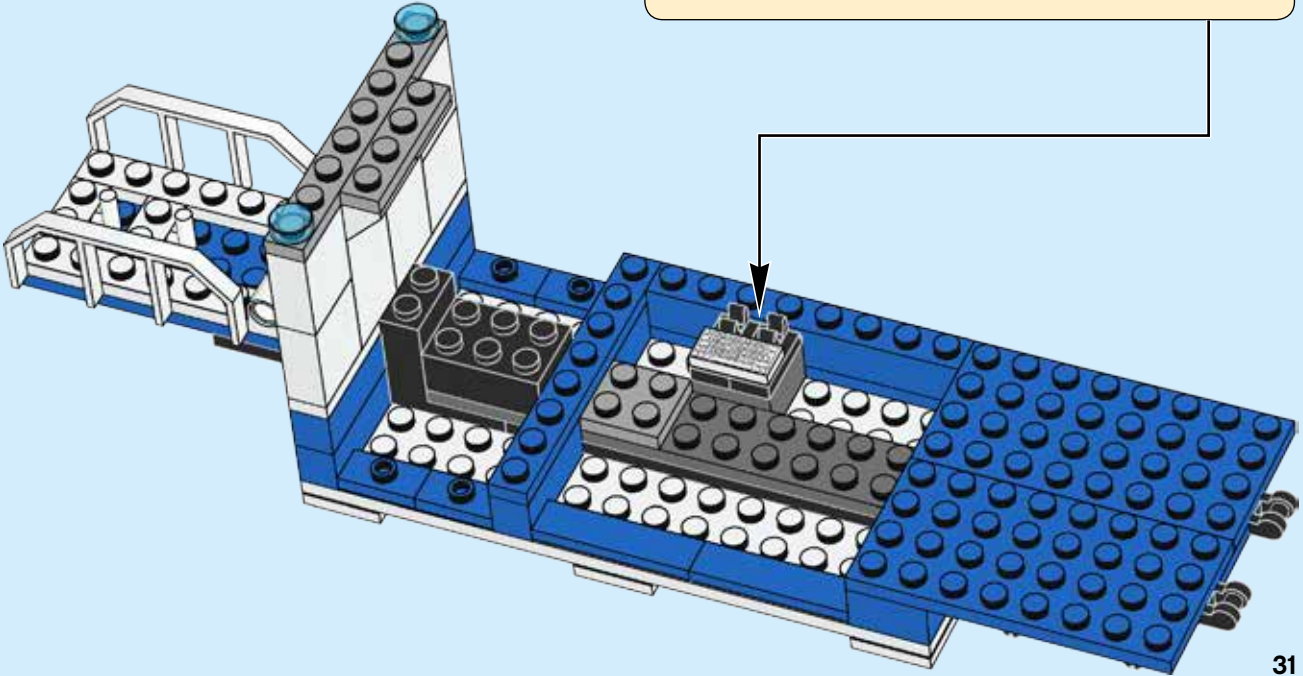
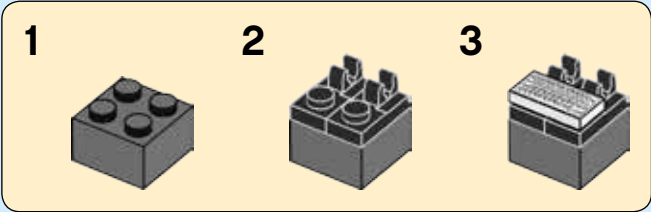

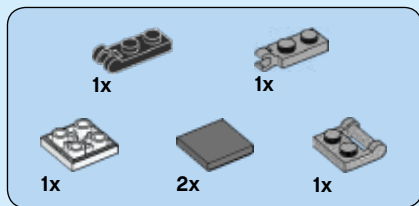

35

1

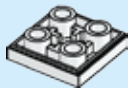

2

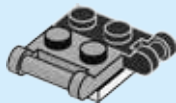

3

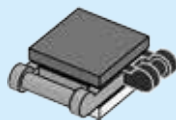

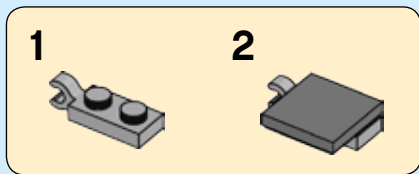

4

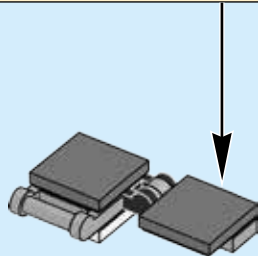

5

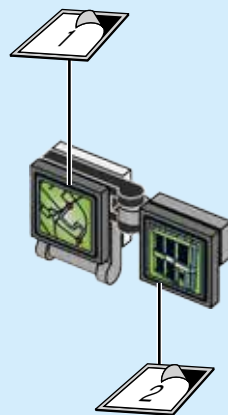

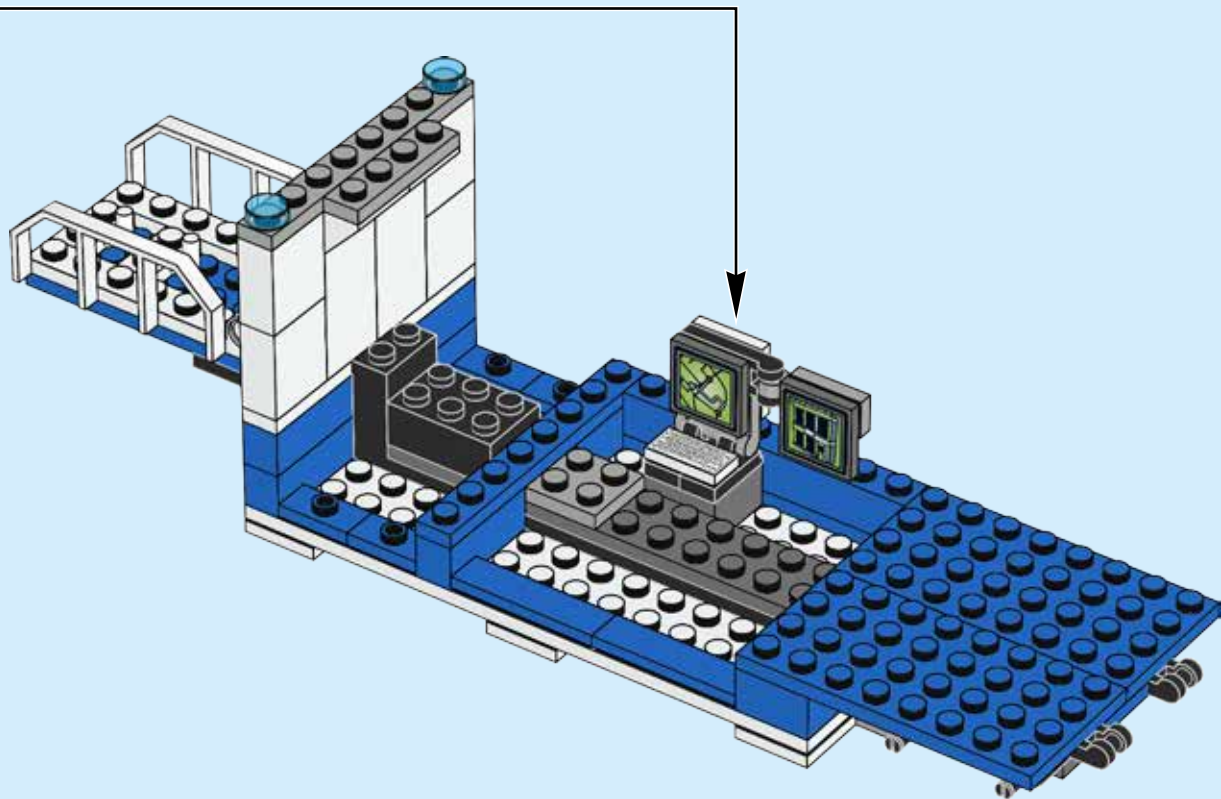

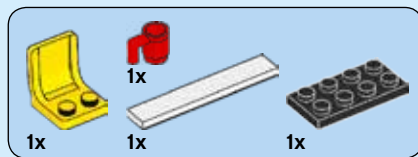

36

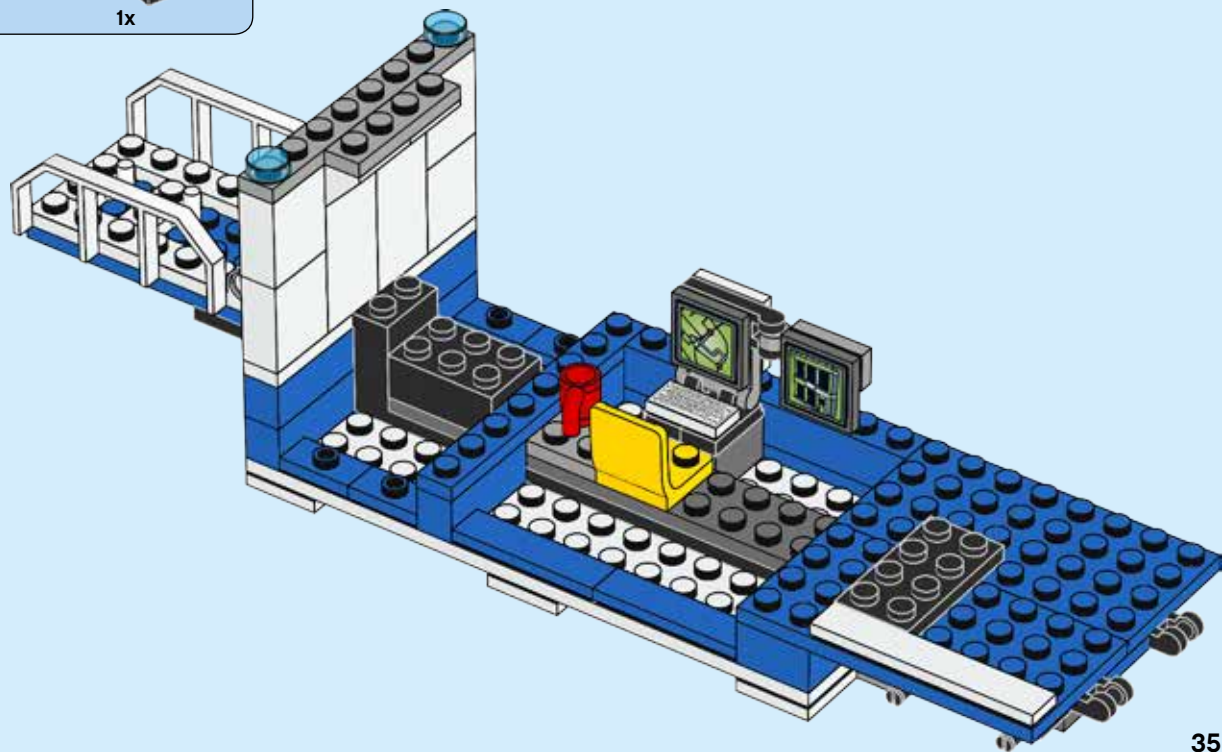



2x



1x

37

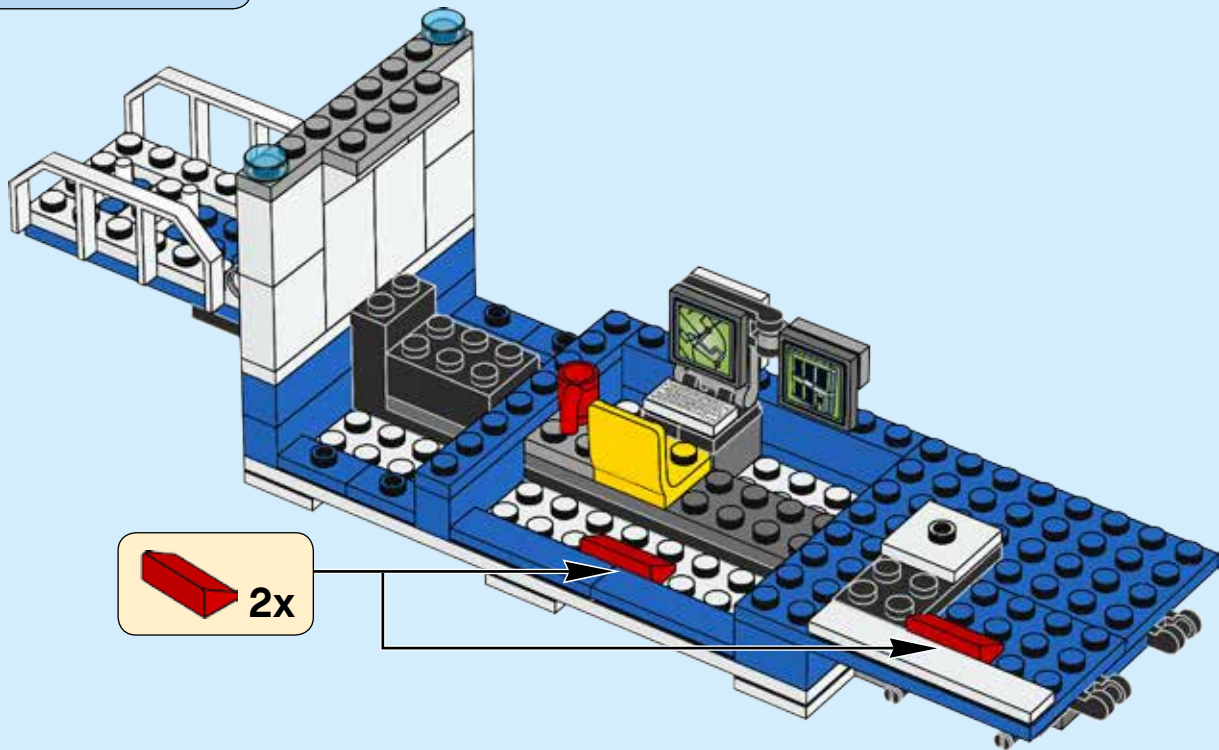

2x

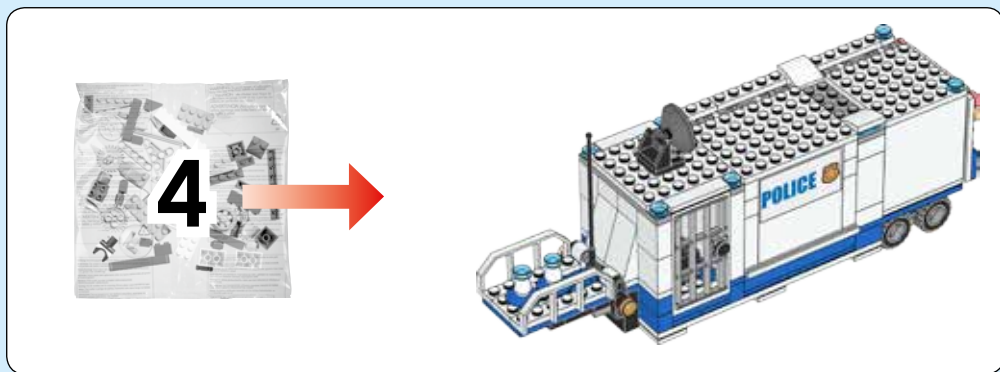

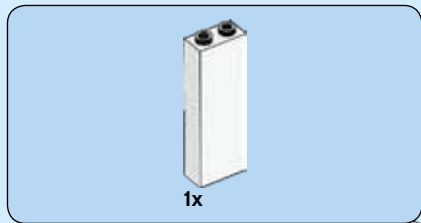

38

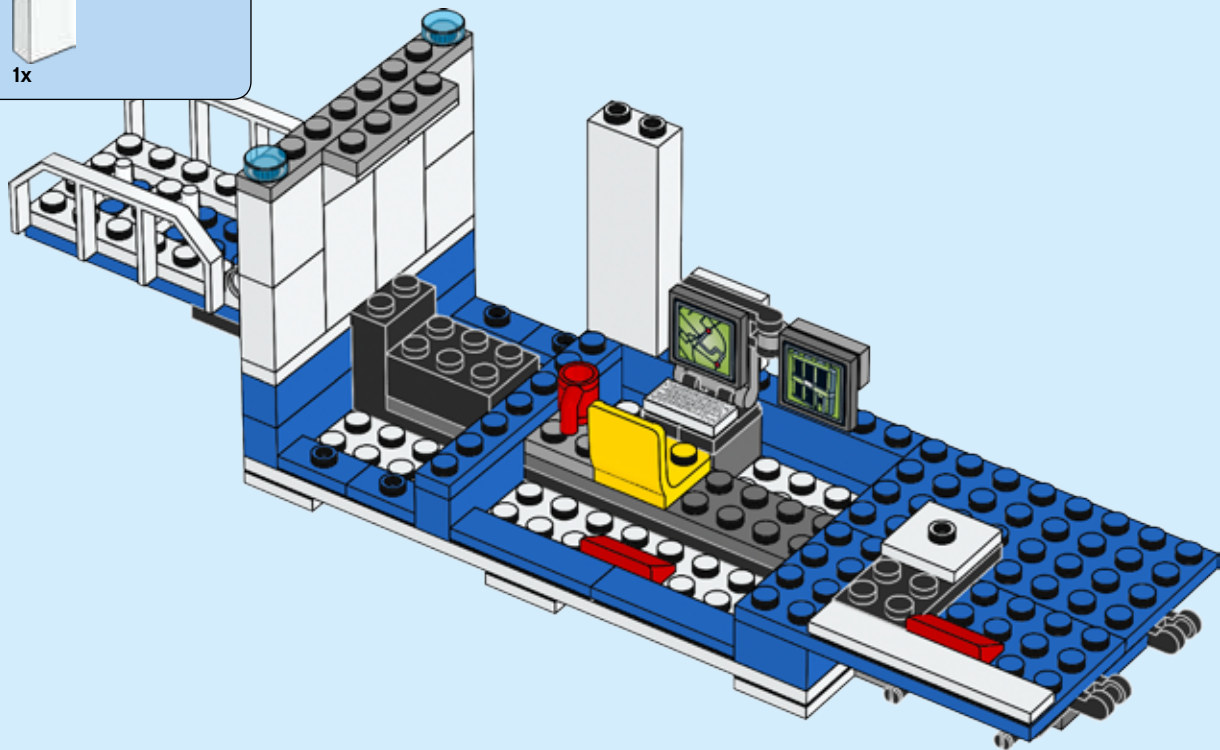

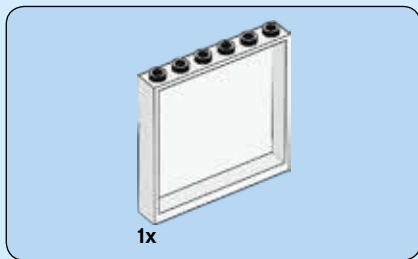

39

1

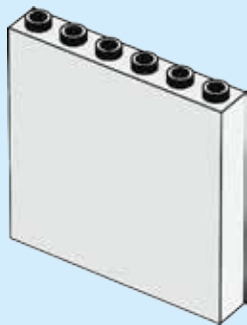

2



3

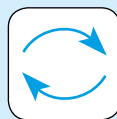
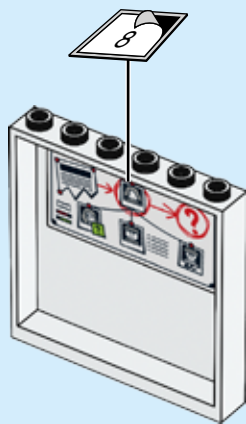

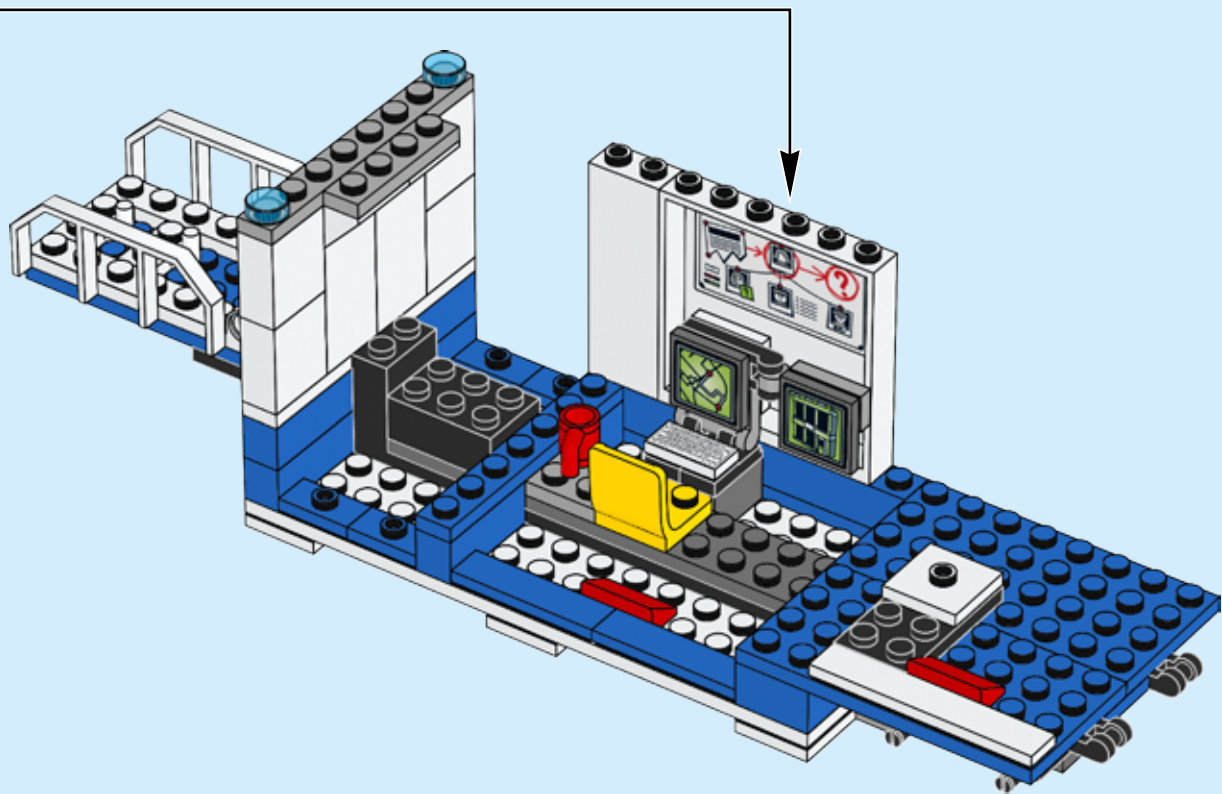

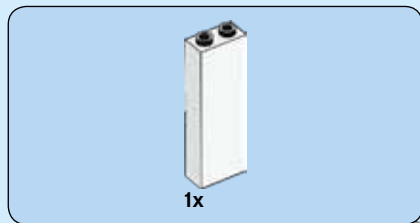

40

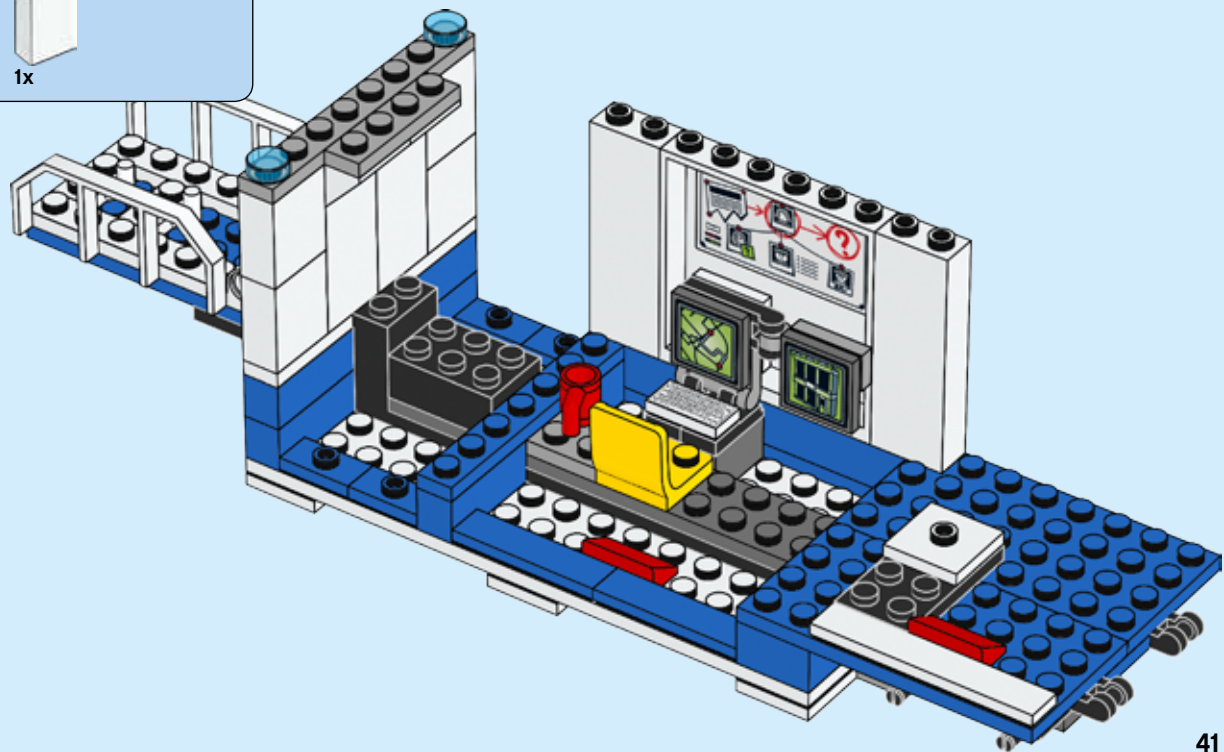

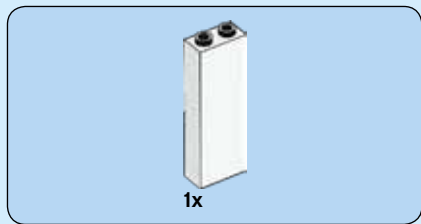

41

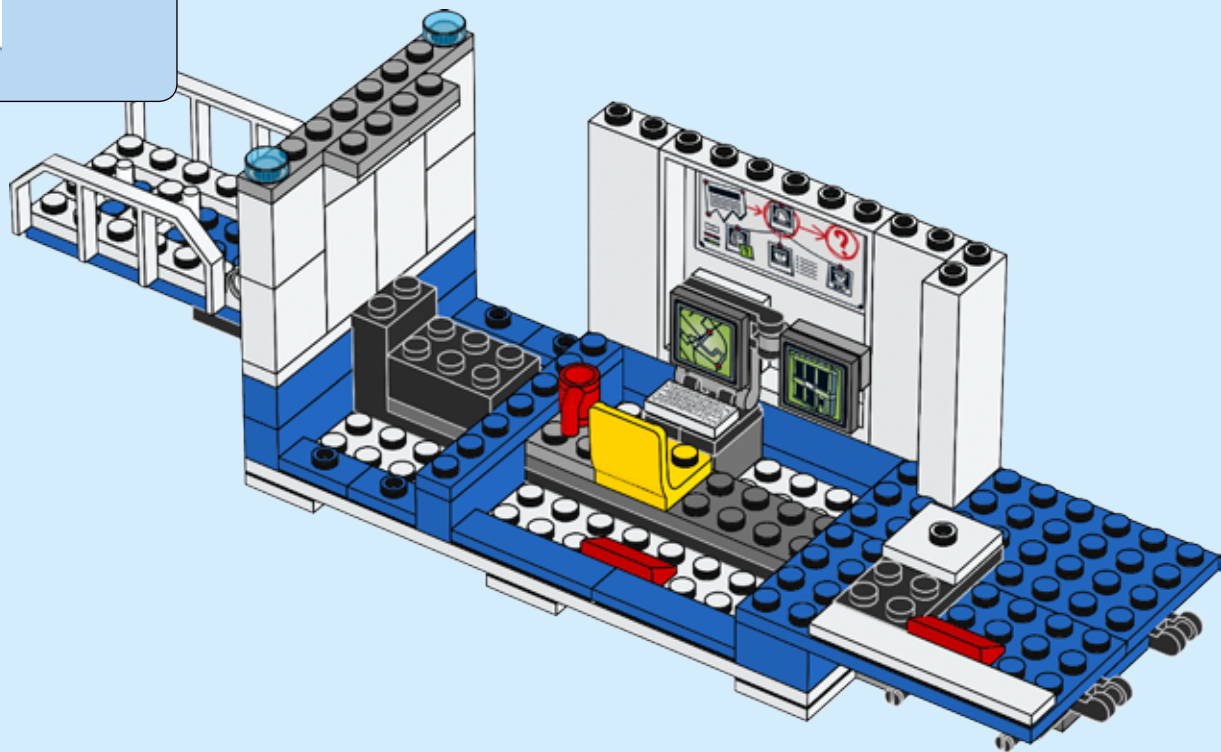

42

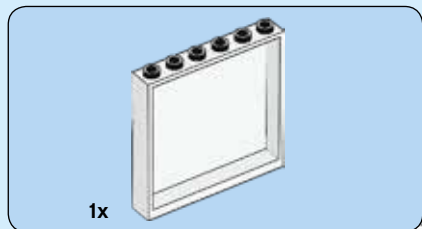

42

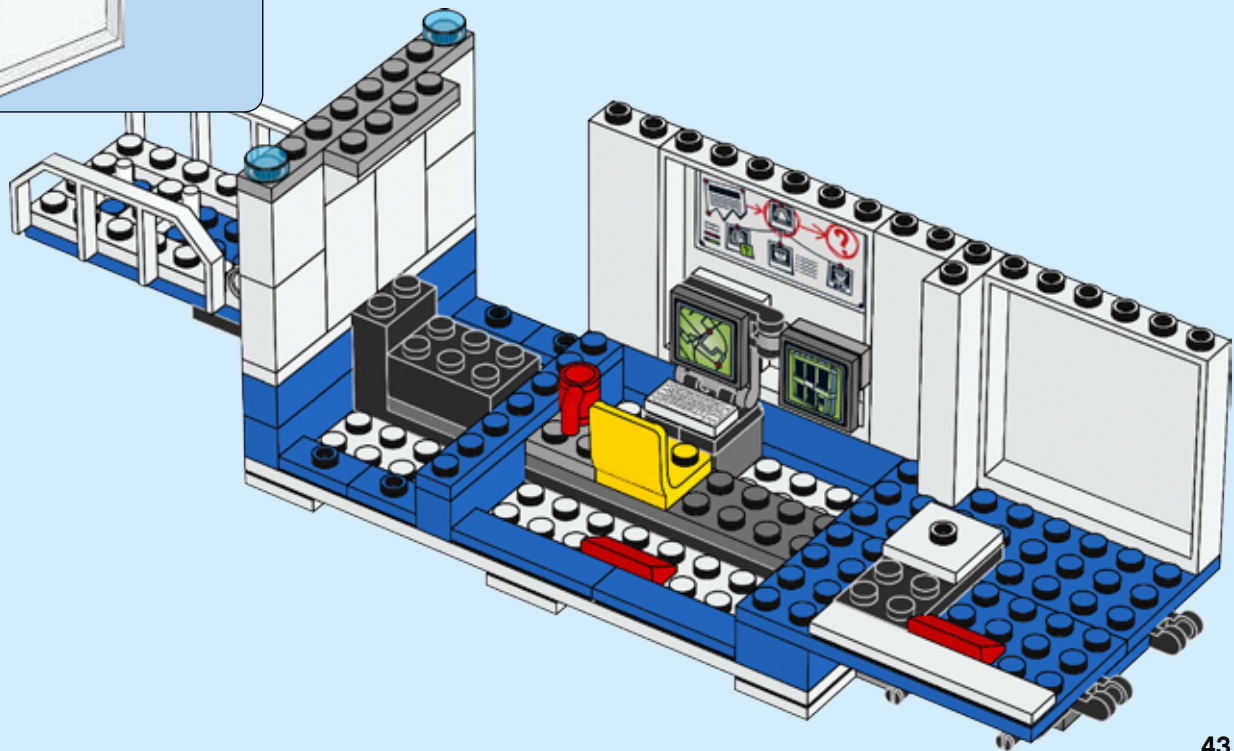

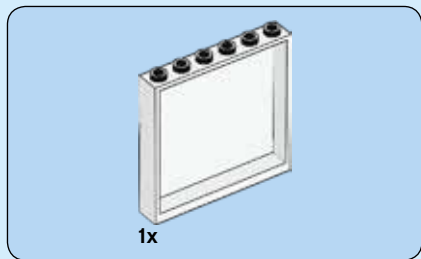

43

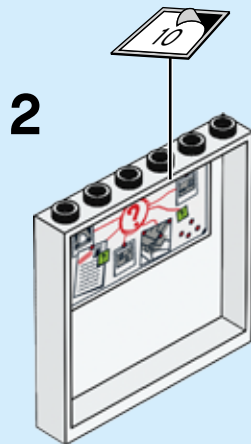
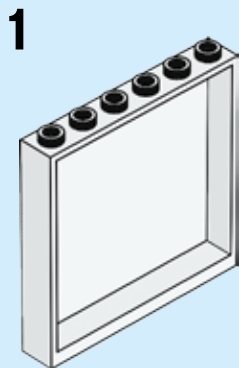

44

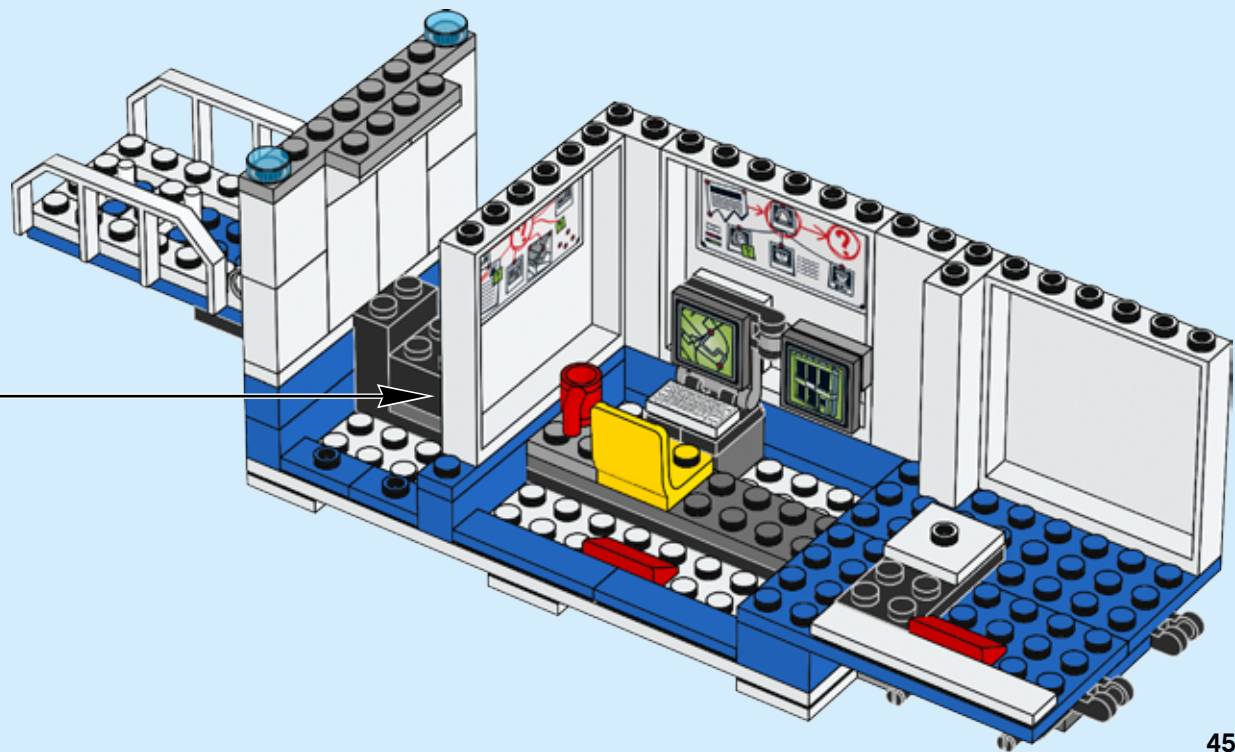



1x

44

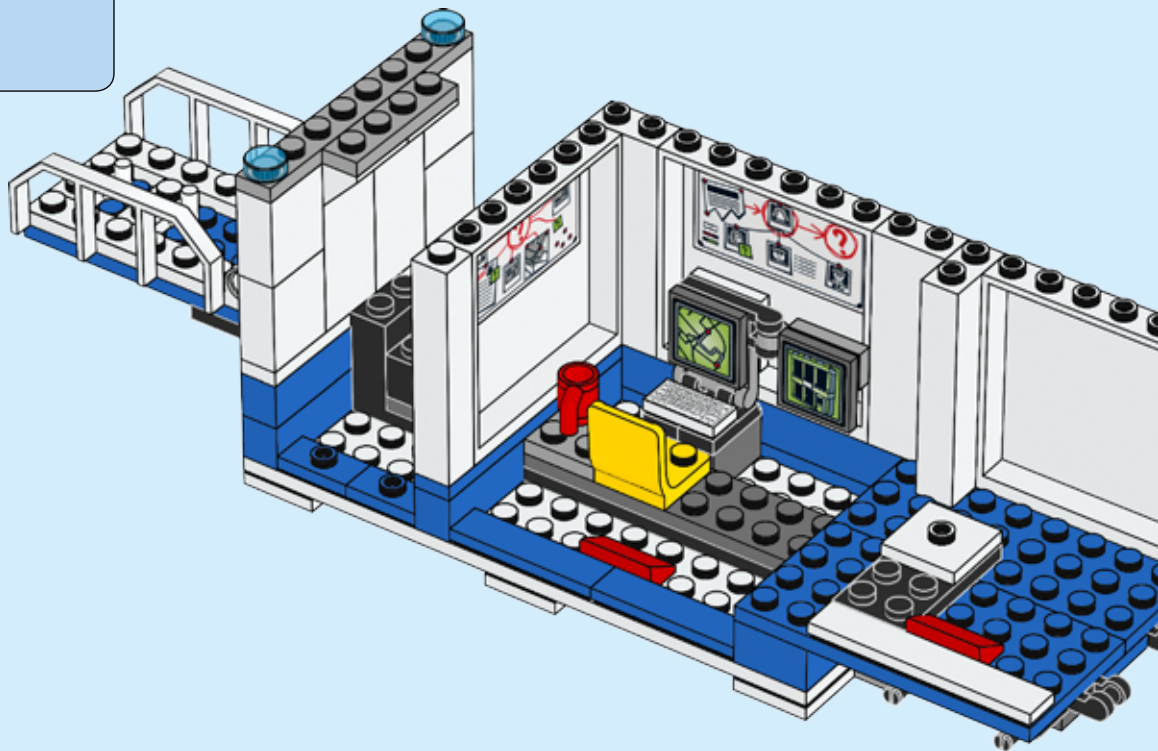

46

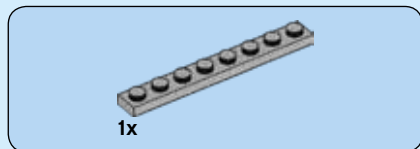

45

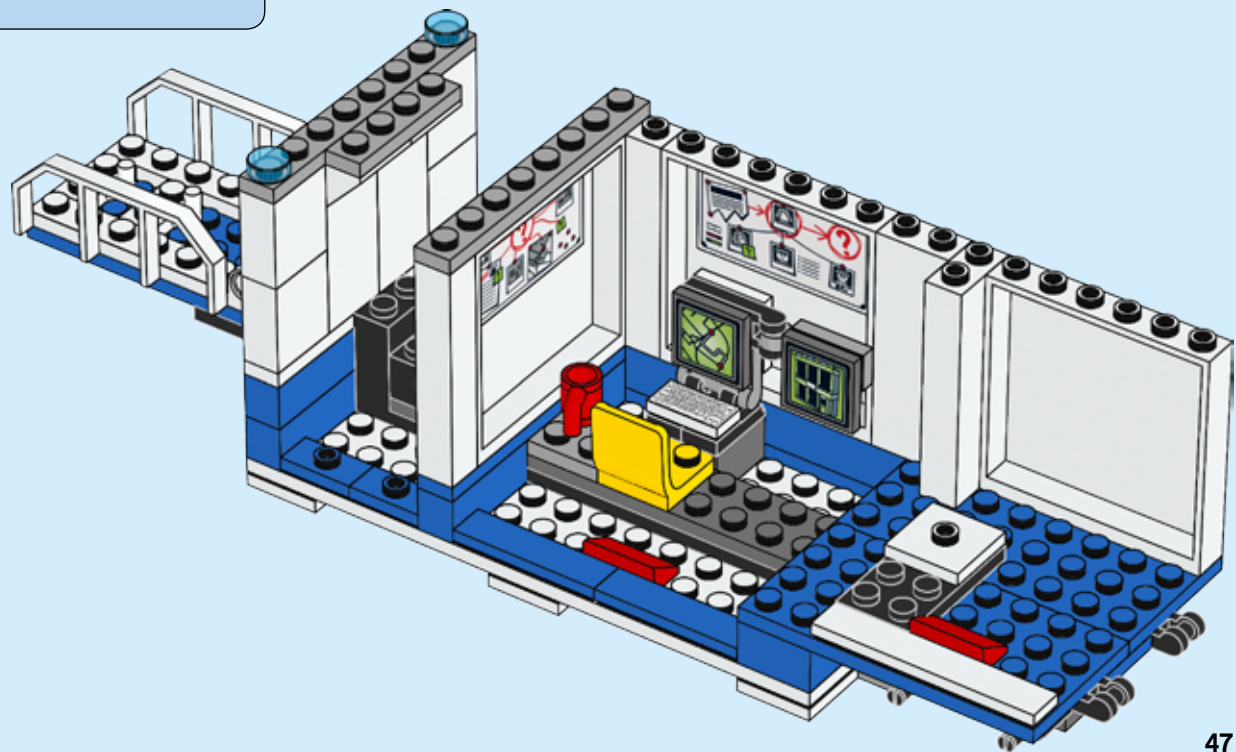

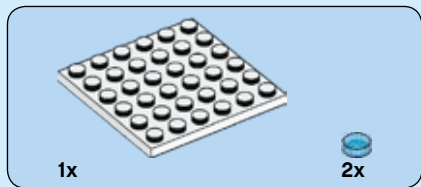

46

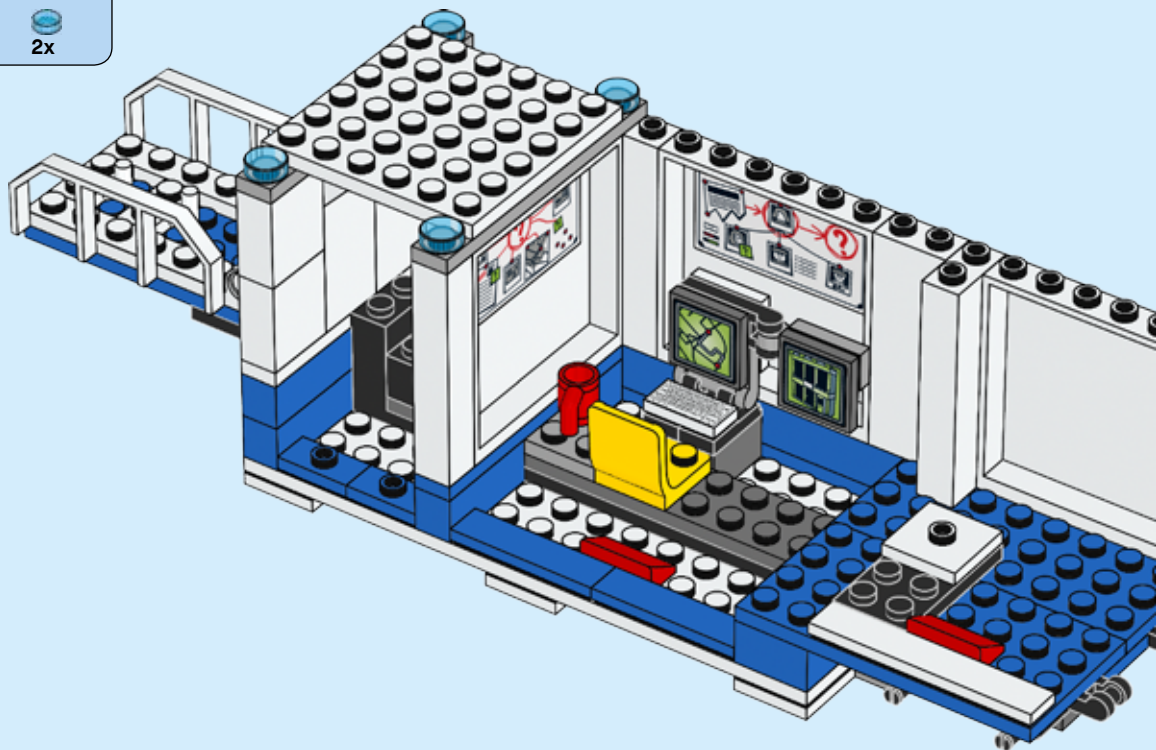

48

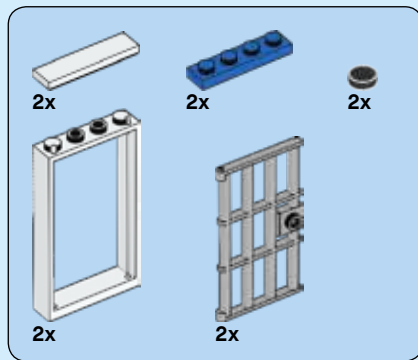
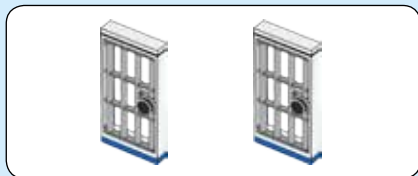

47

1

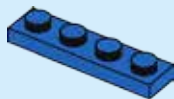

2

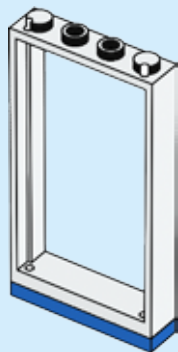

3

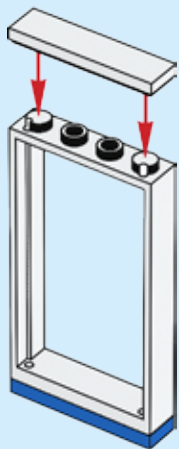

4

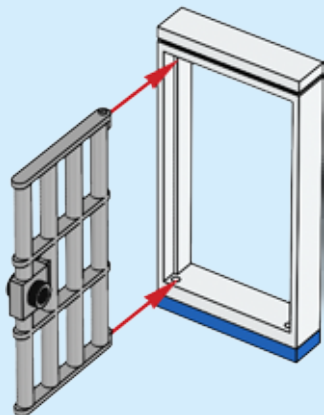

5

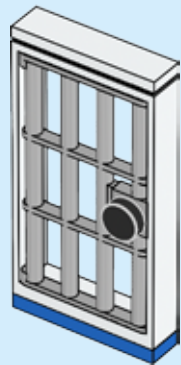

2x

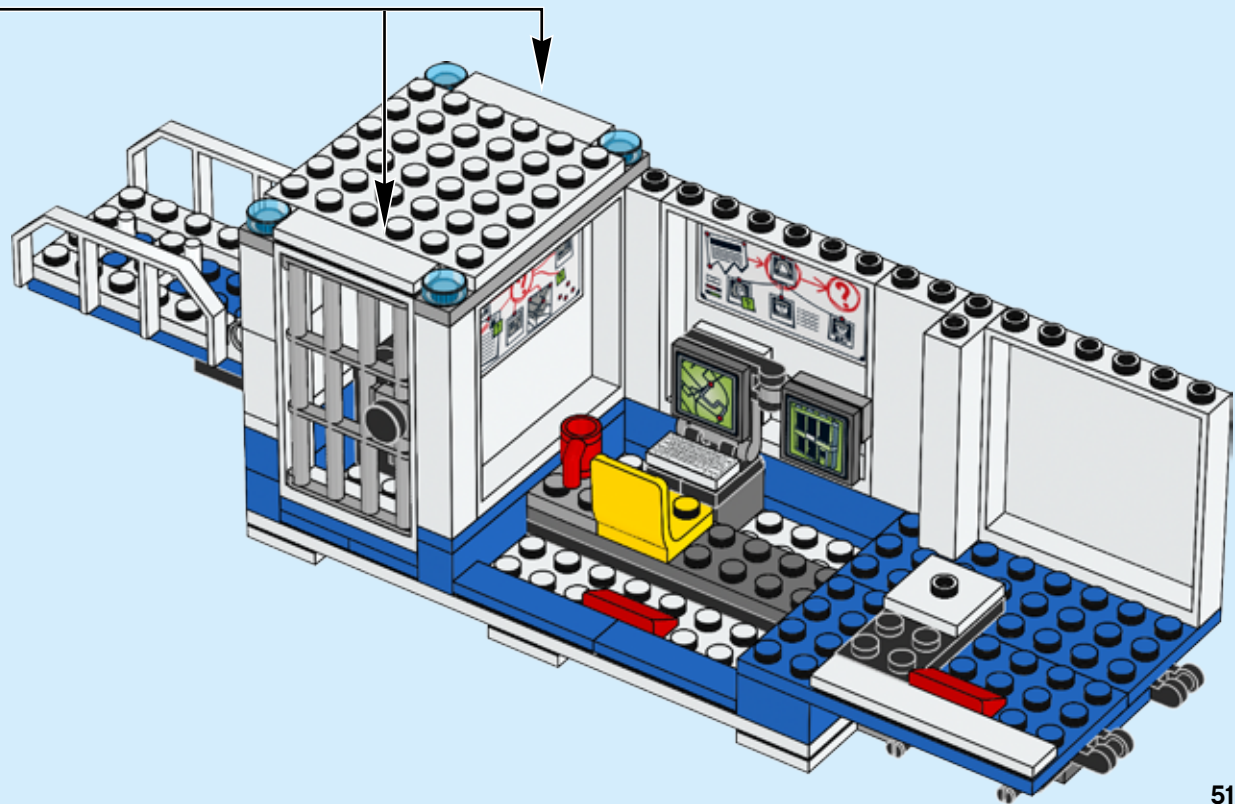

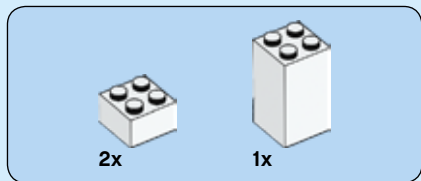

48

1

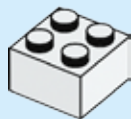

2



3

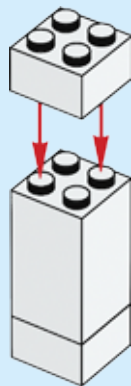

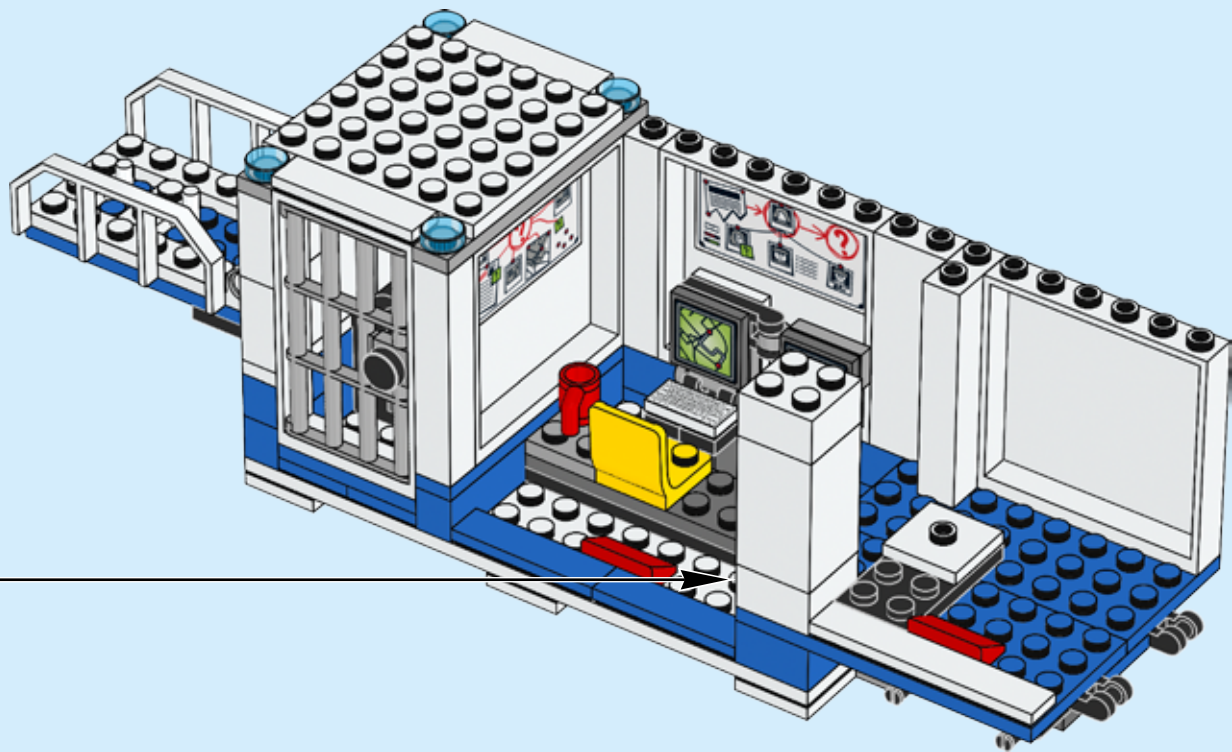



4x

49

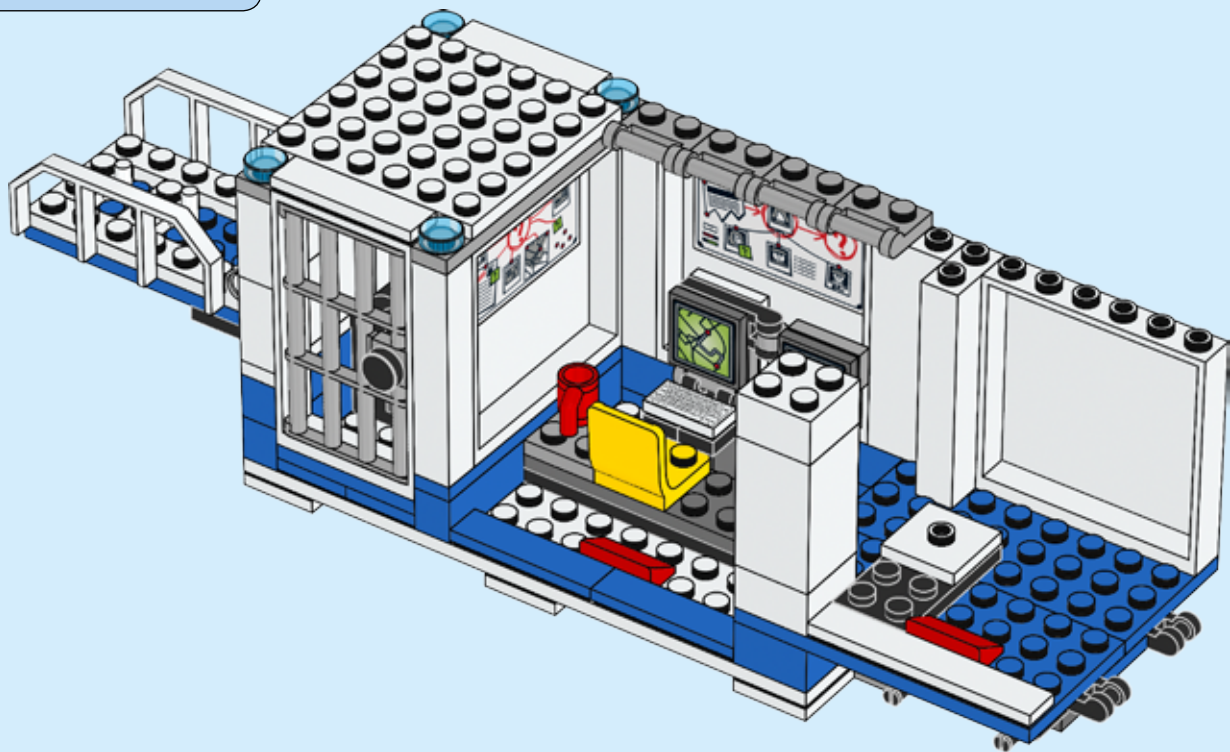

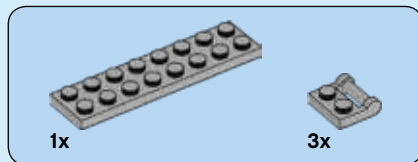

50

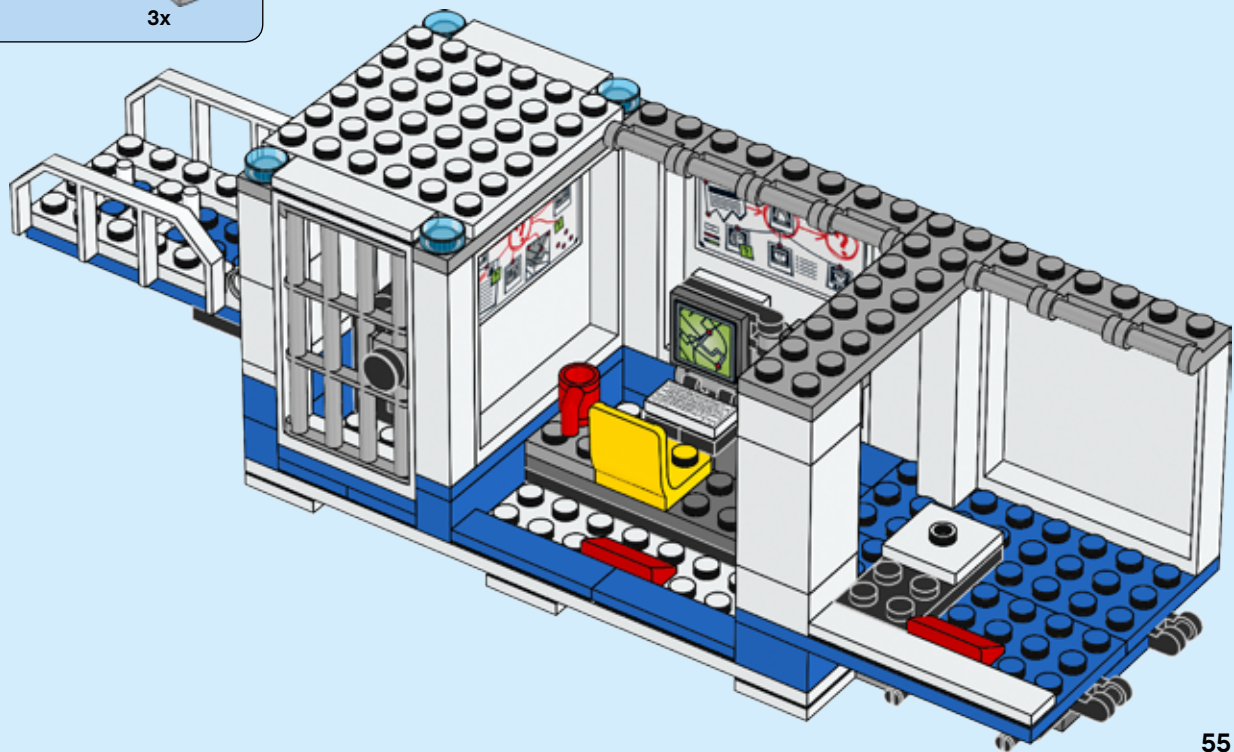

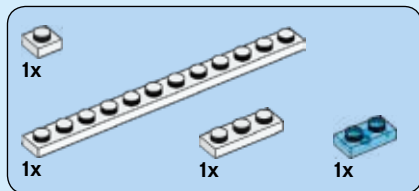

51

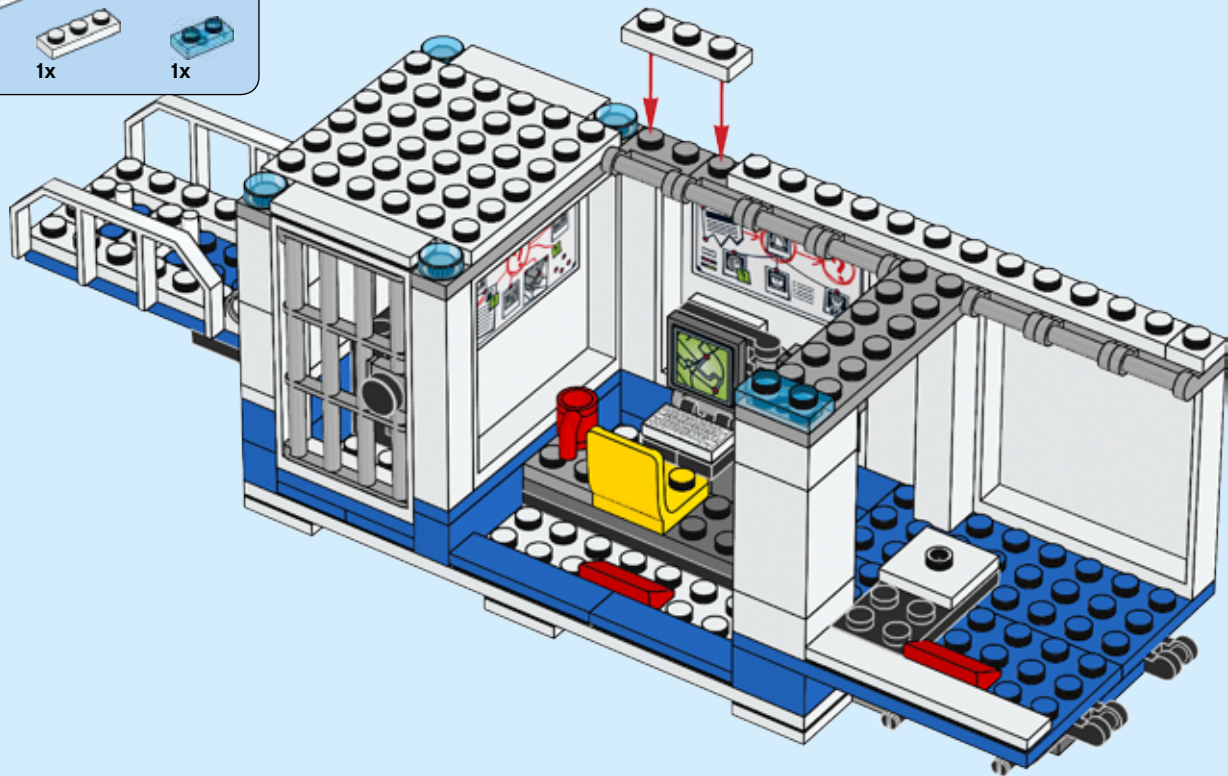

56



2x

52

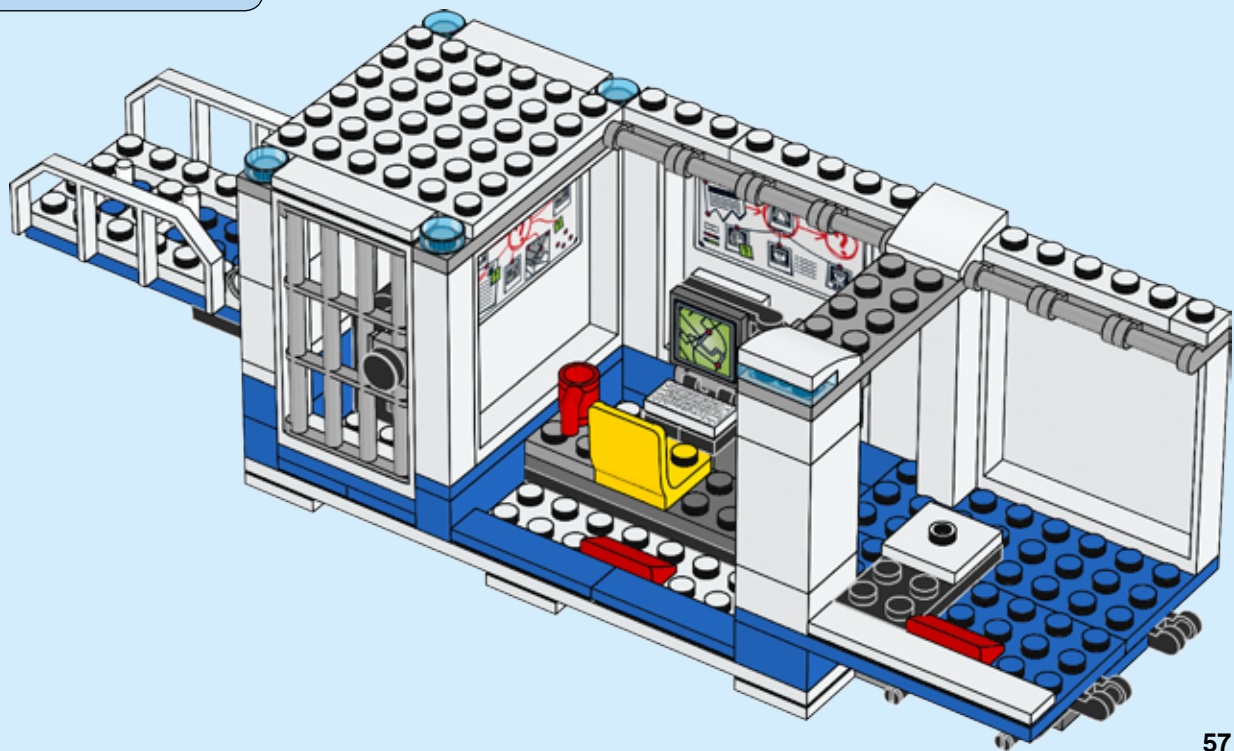

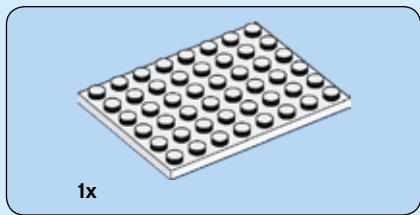

53

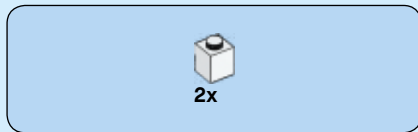
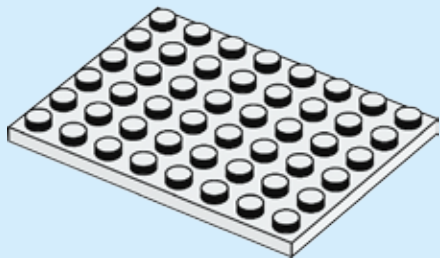

54

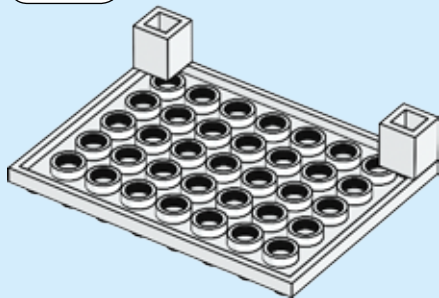
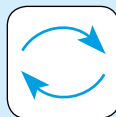

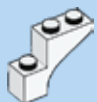

2x

55

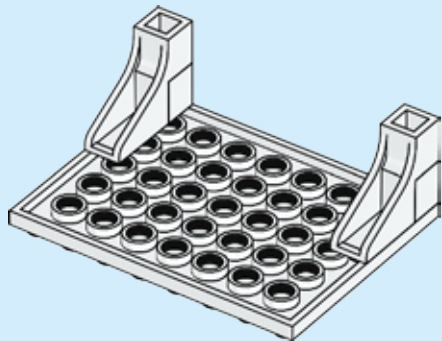

1x

56

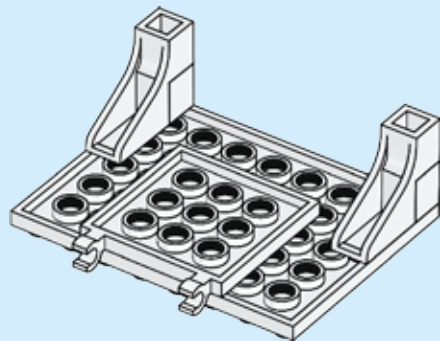



2x

57

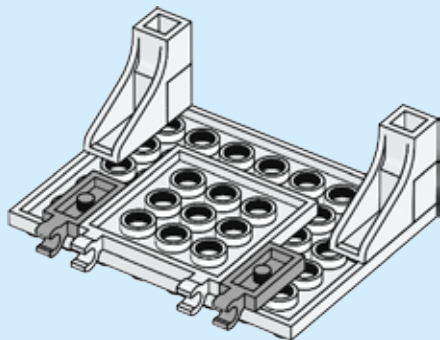

60



2x

58

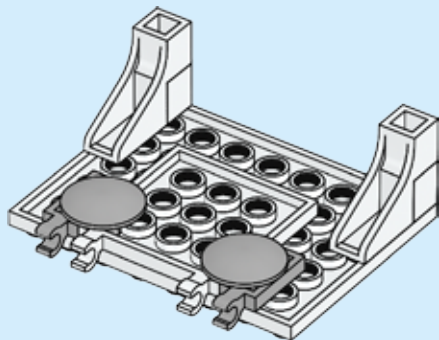

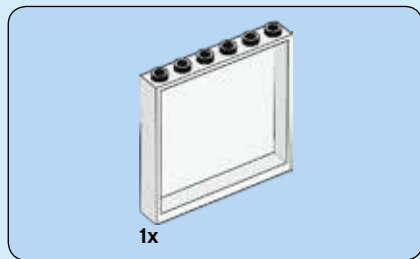

59

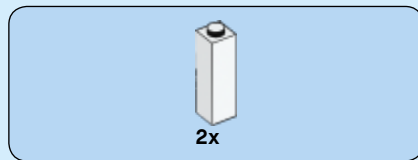
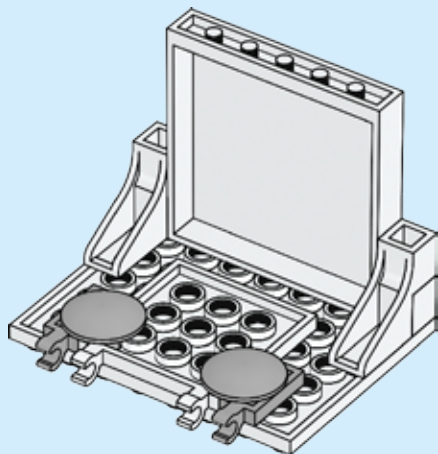

60

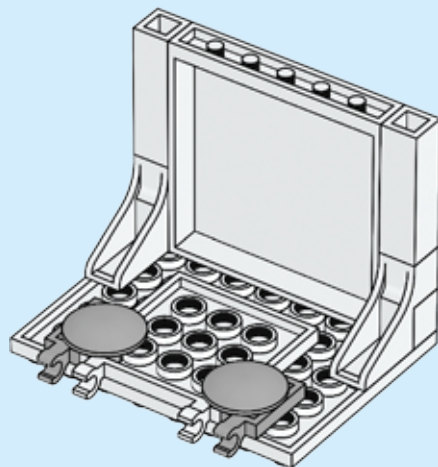

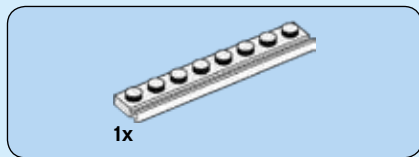

61

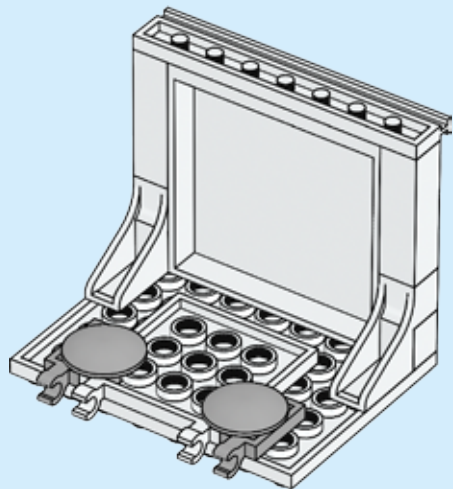

62

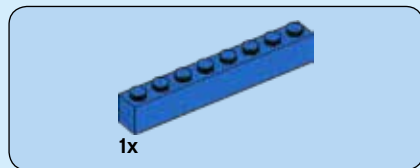

62

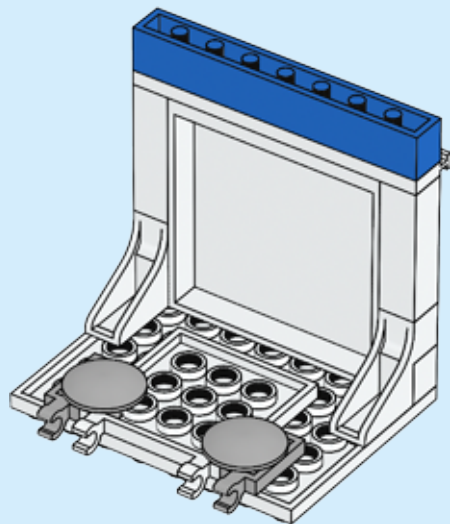

63

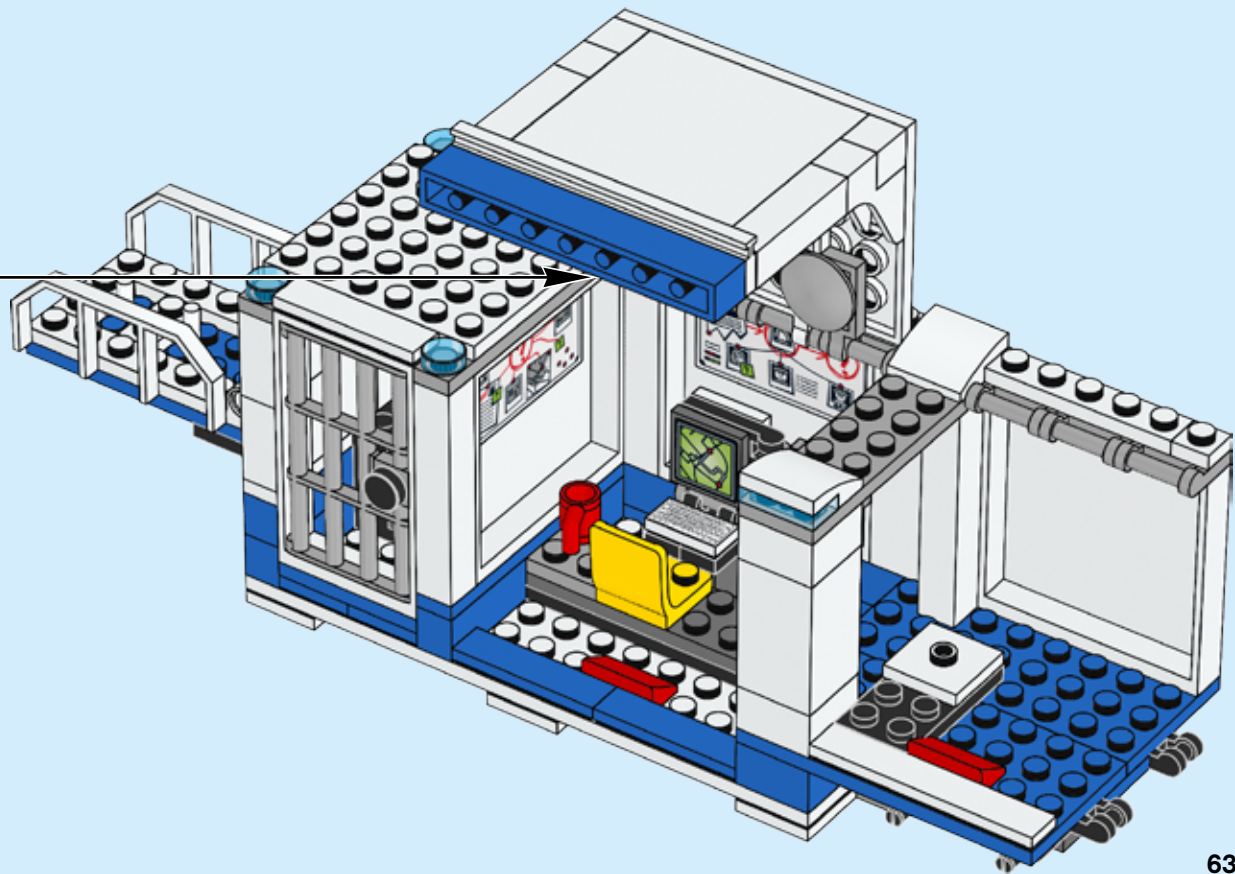

64

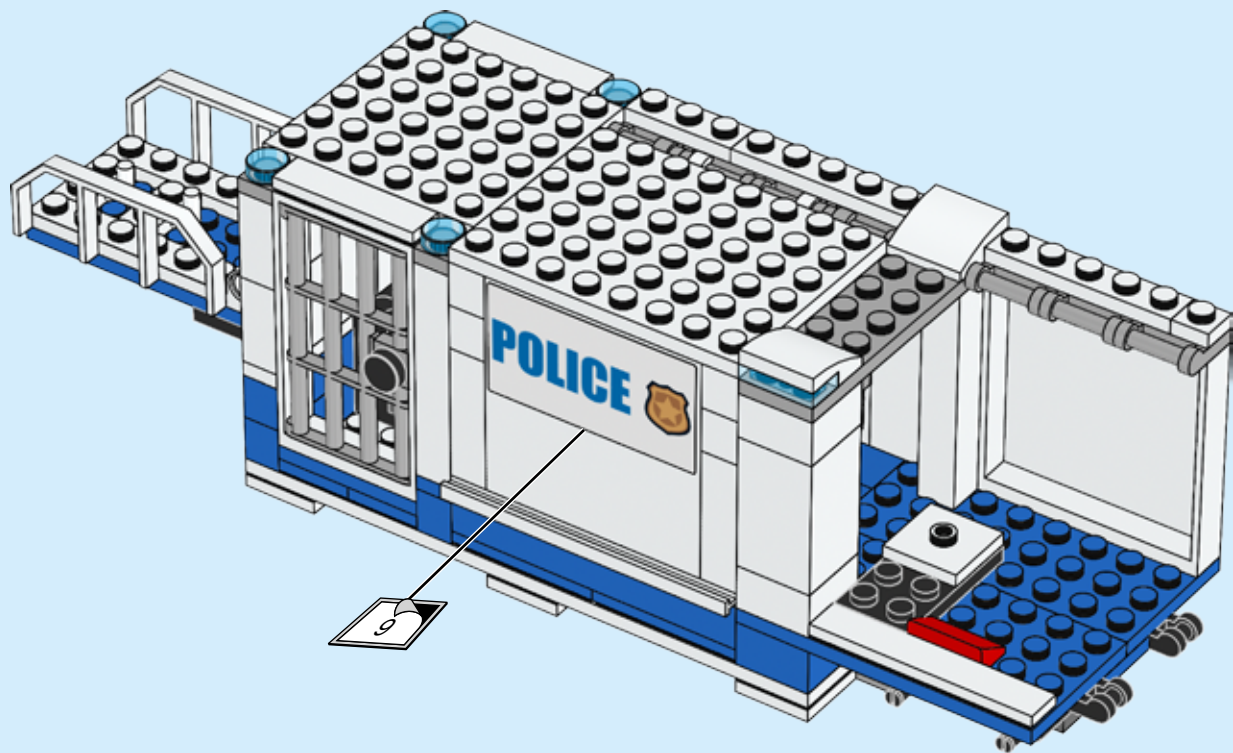

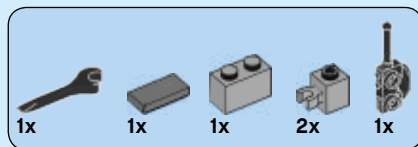

65

1

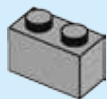

2

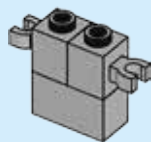

3

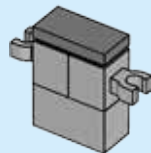

4

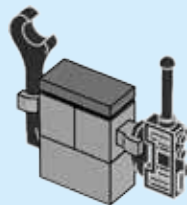

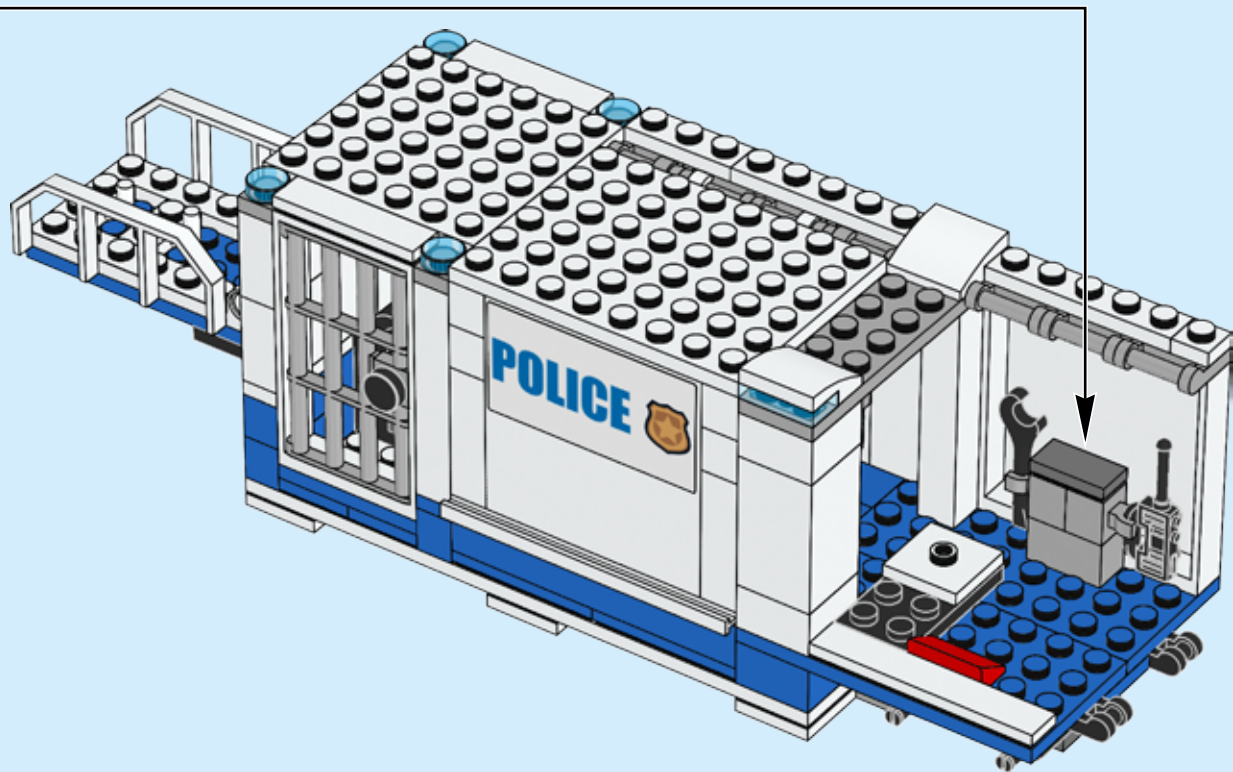

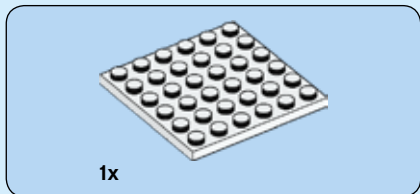
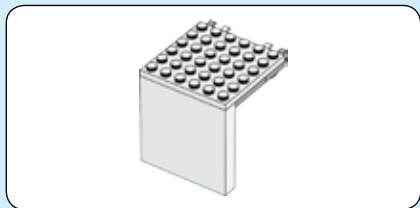

66

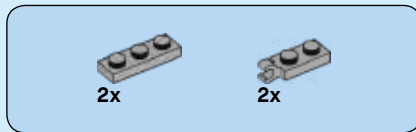
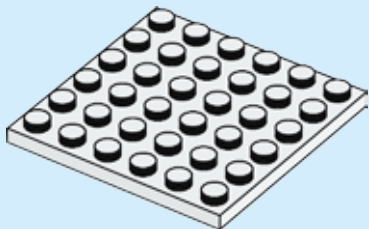

67

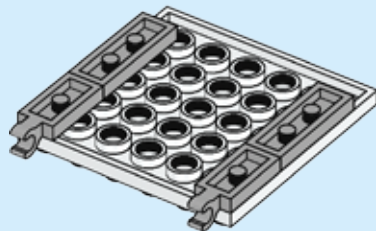
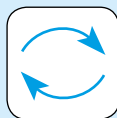



1x

68

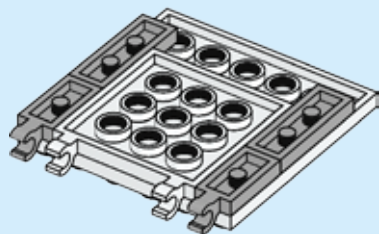

68



2x

69

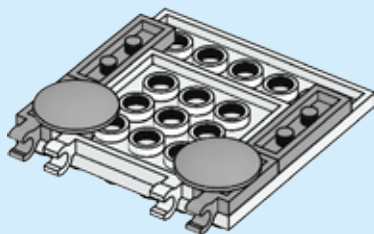

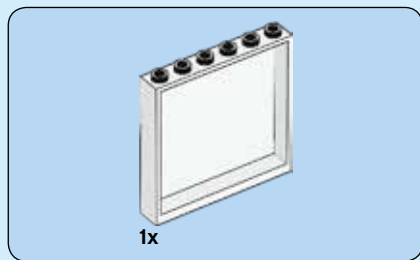

70

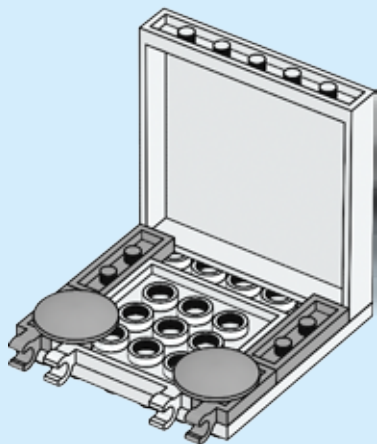

71

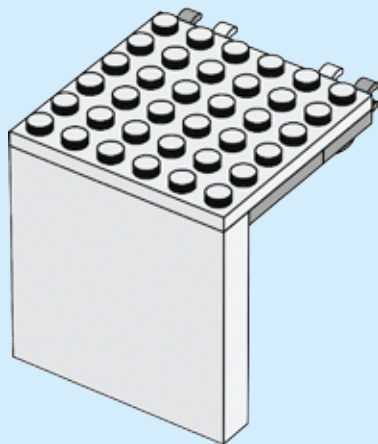
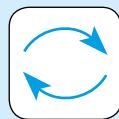

72

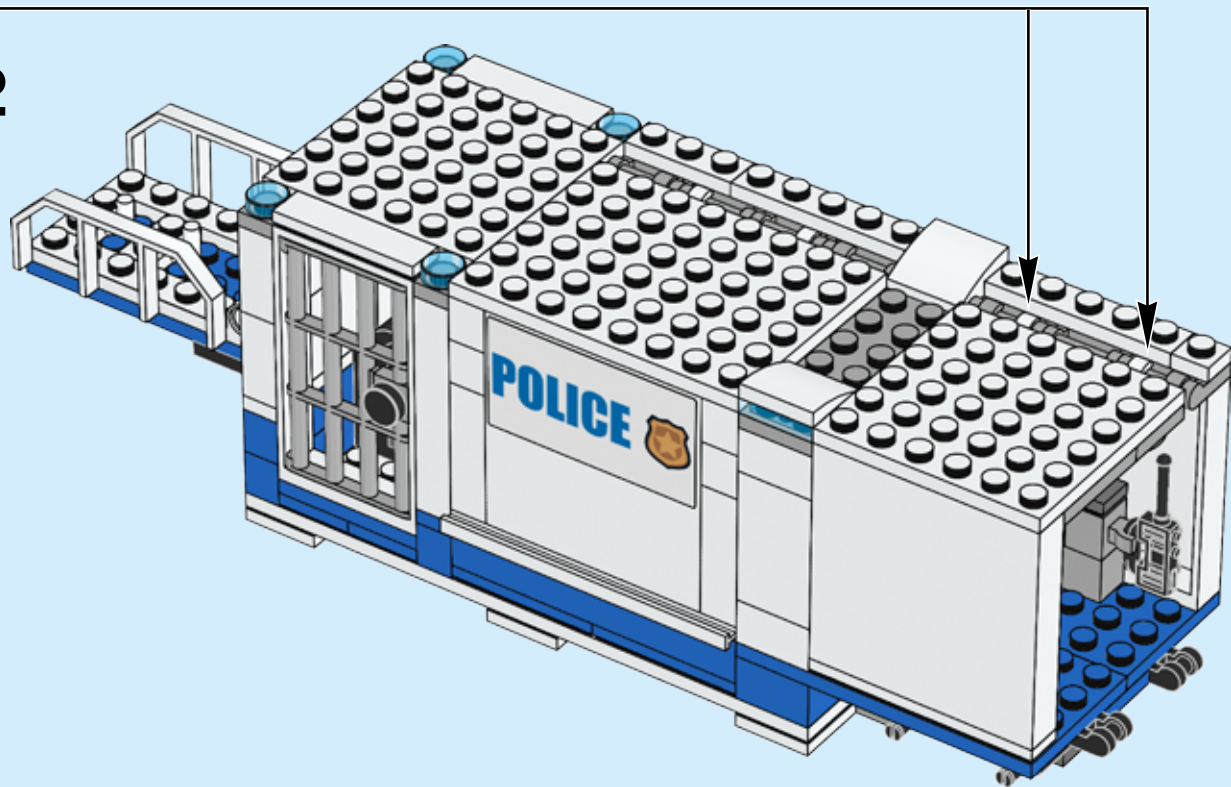

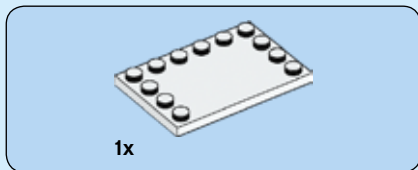
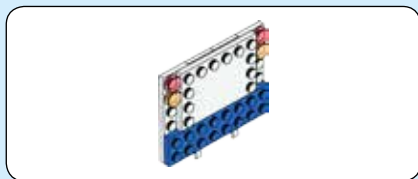

73

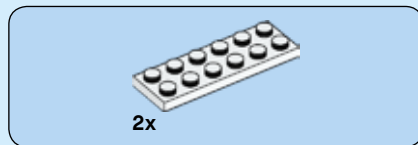
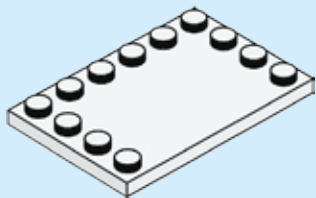

74

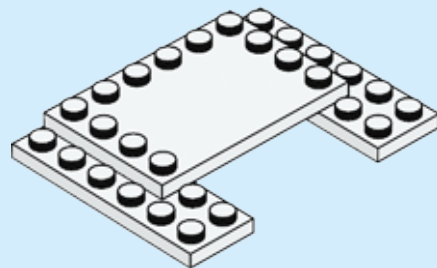



2x



2x

75

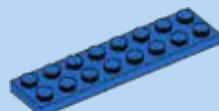
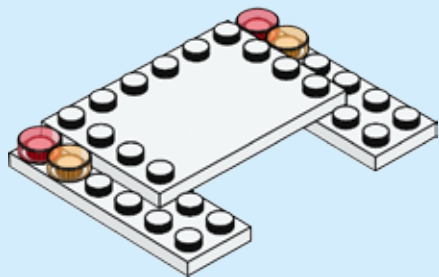

1x

76

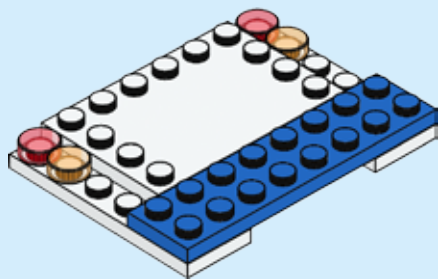



2x

77

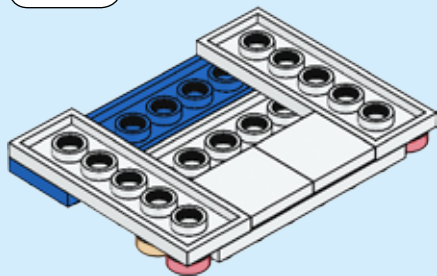
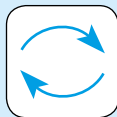

1x

78

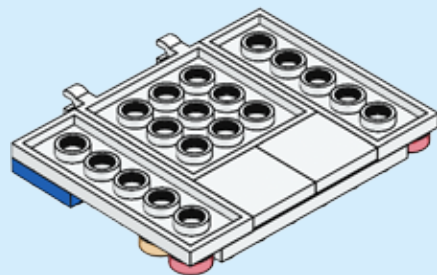

79

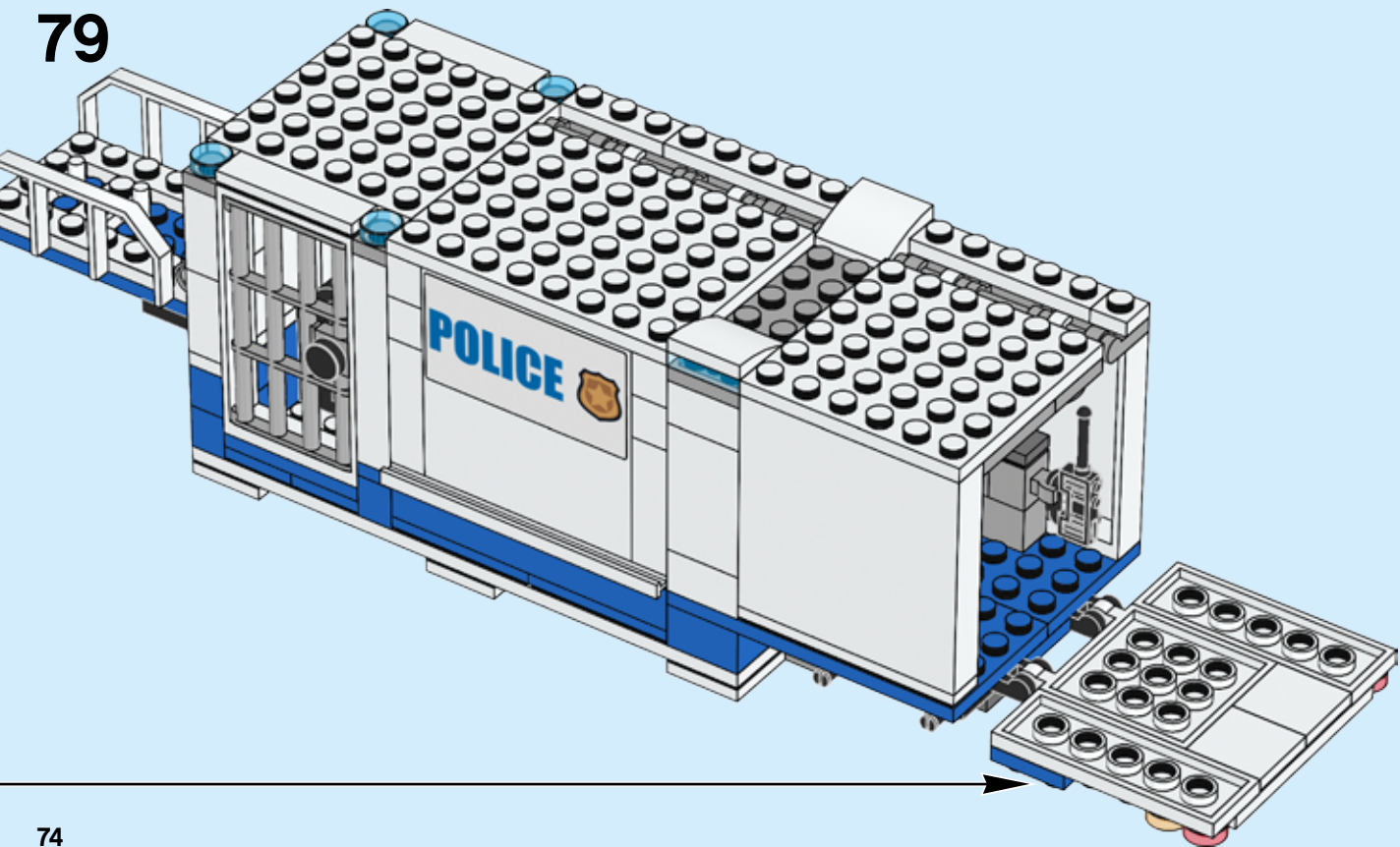

74



80

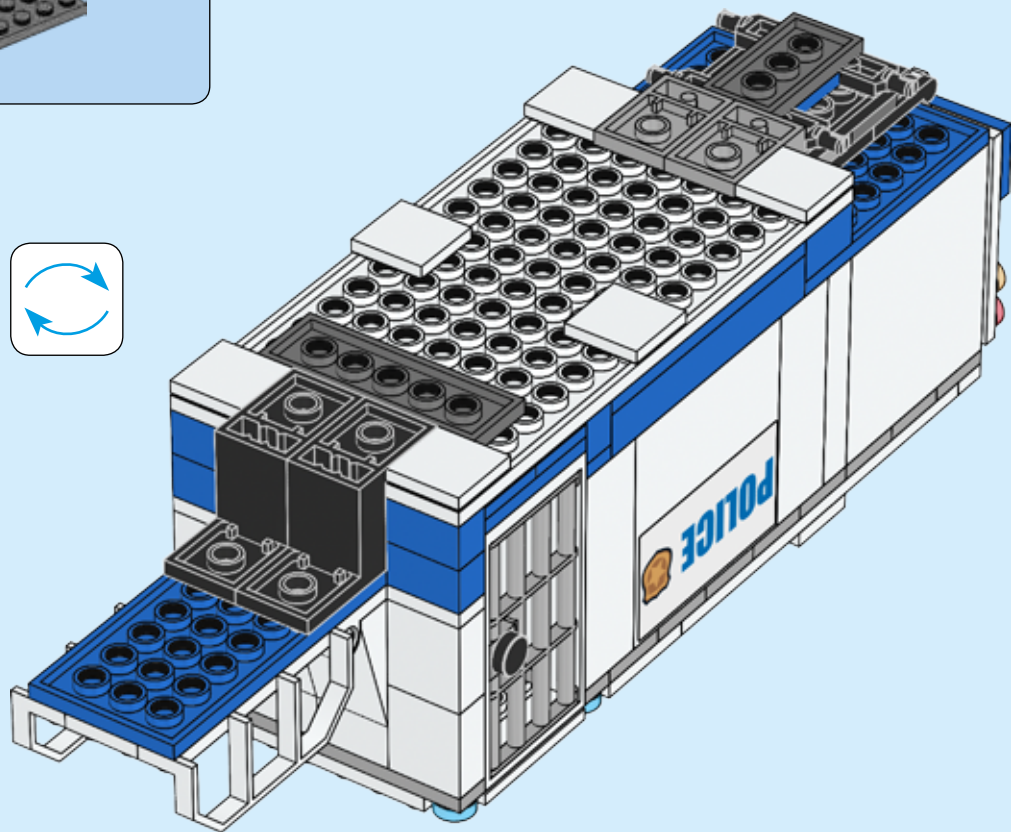
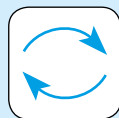



2x

81

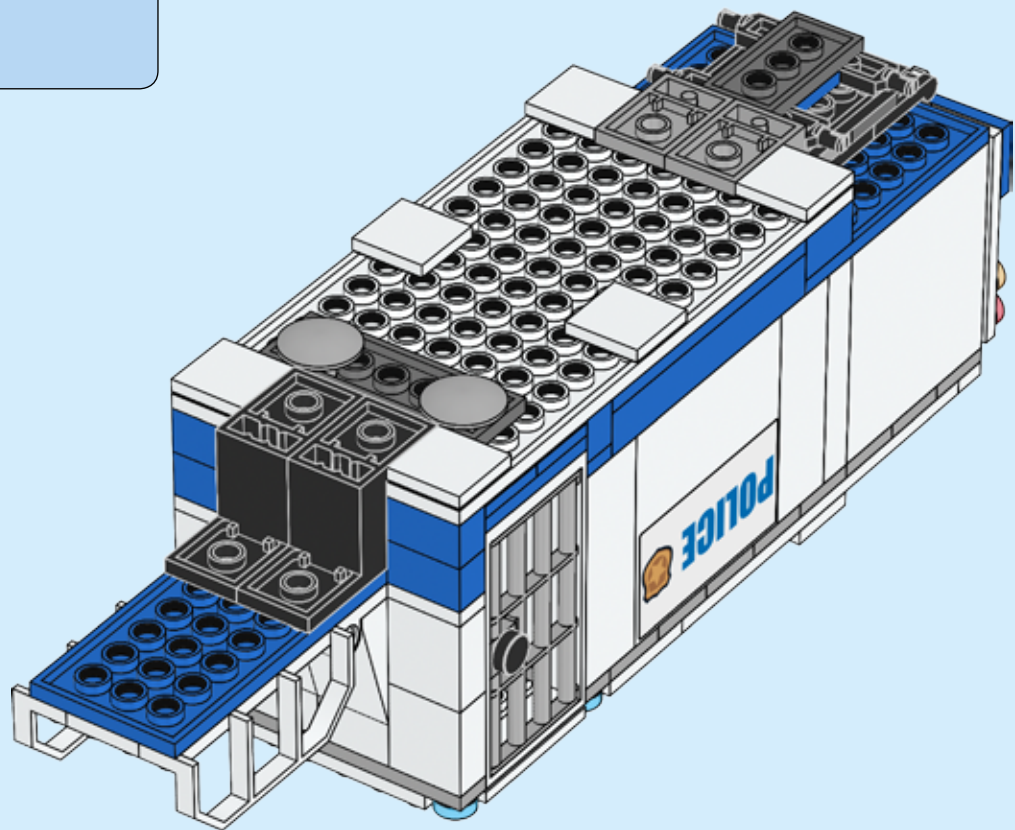

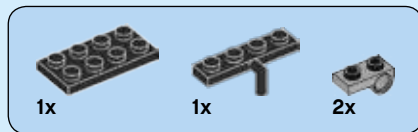

82

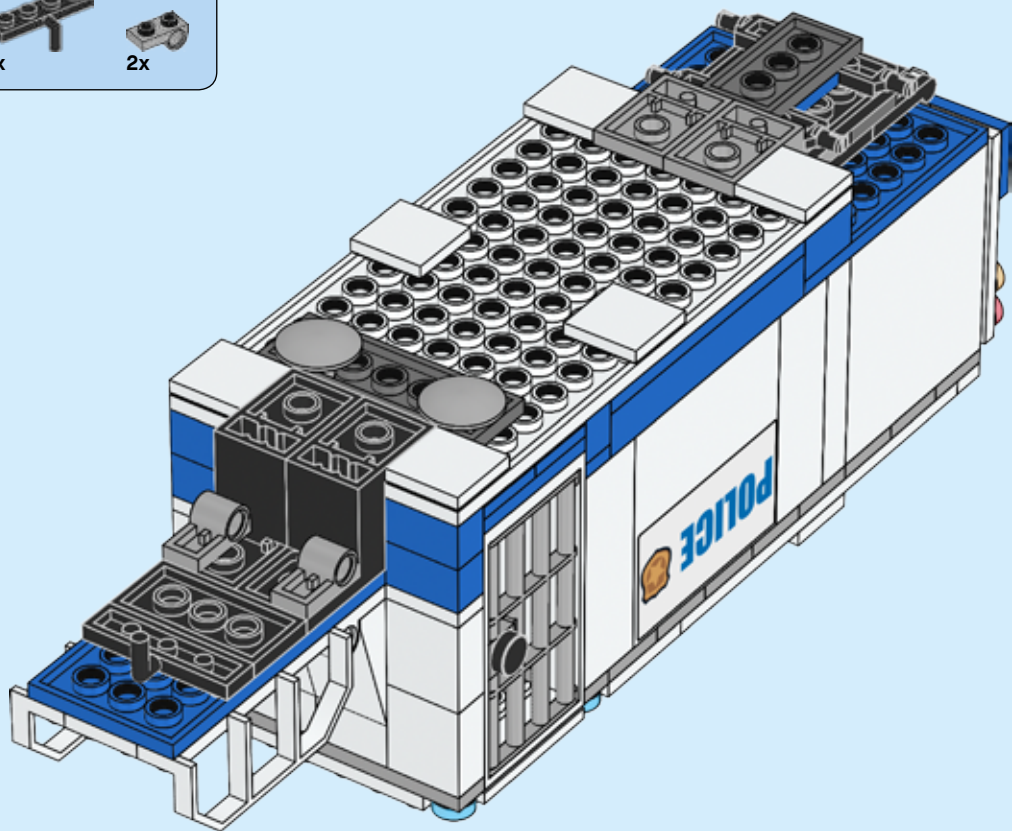



83

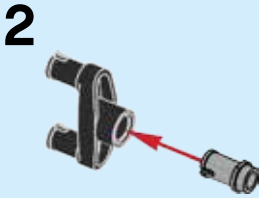

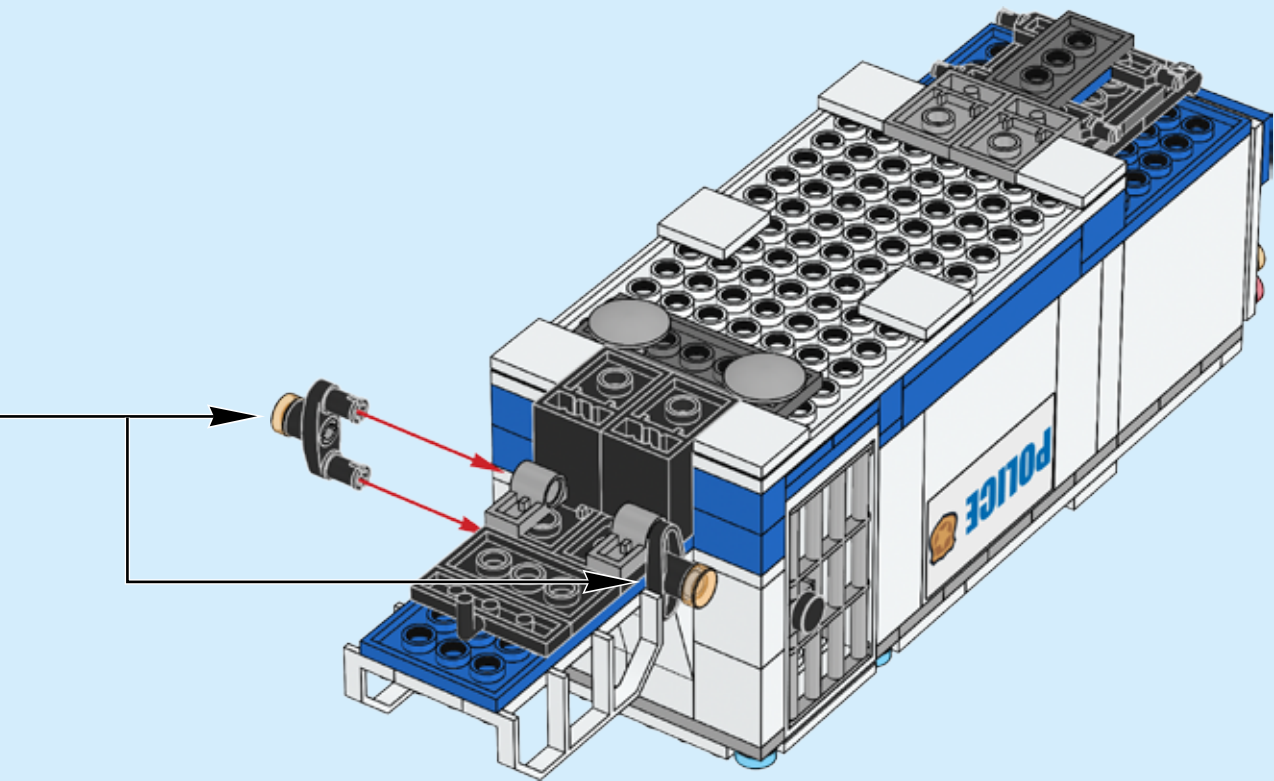



1x



1x



1x

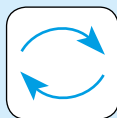

84

1



2

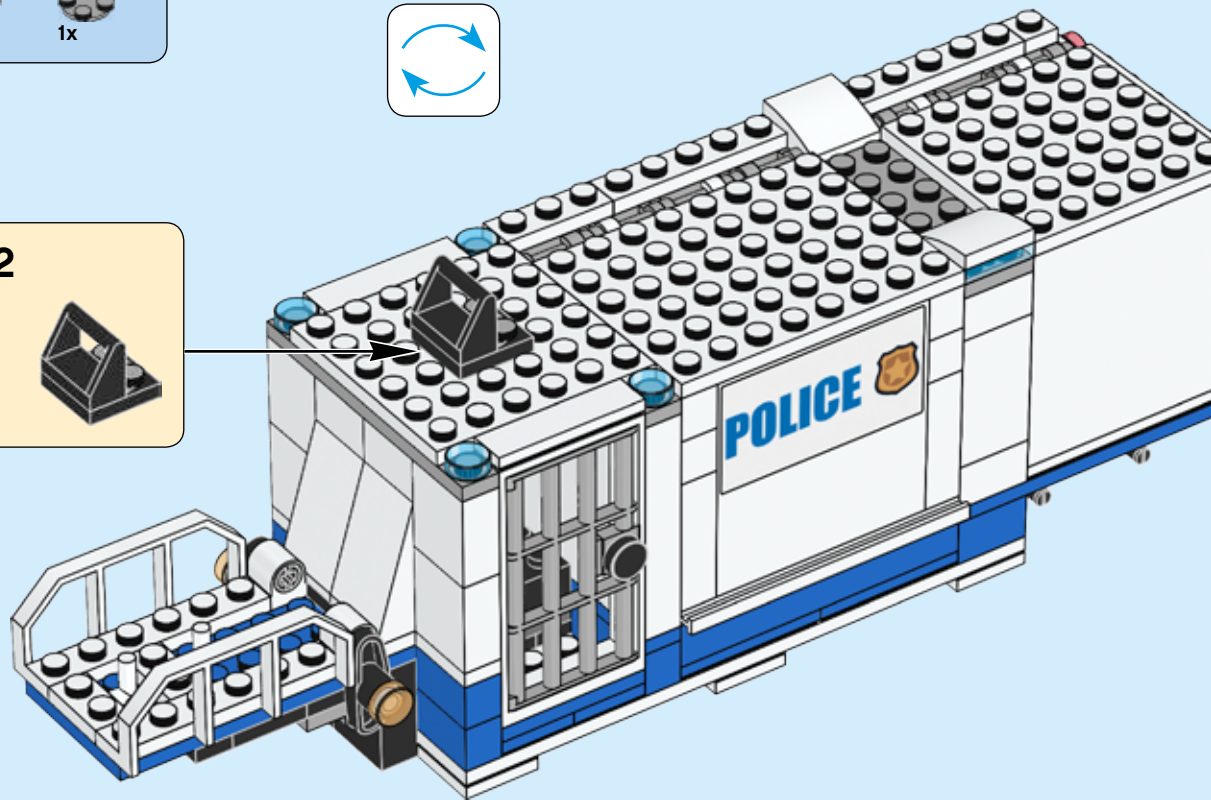



2x



1x



1x

85

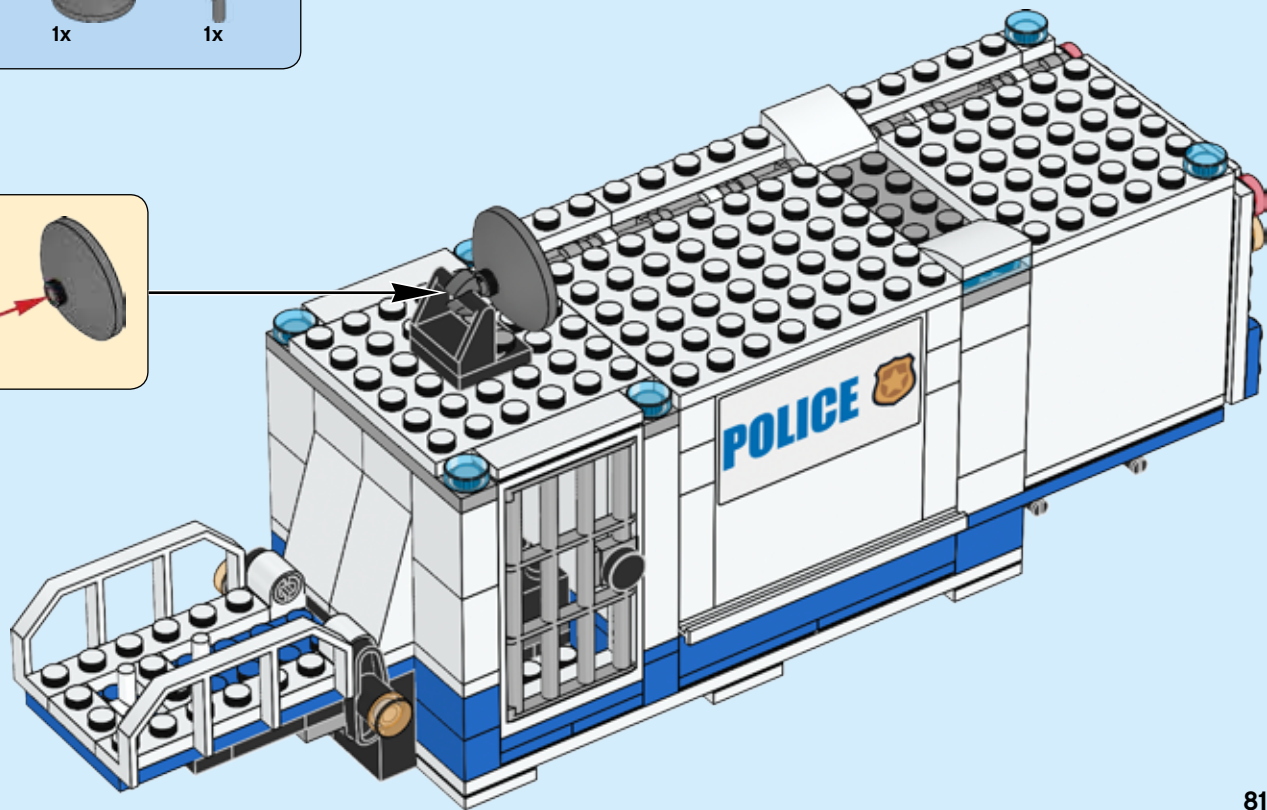
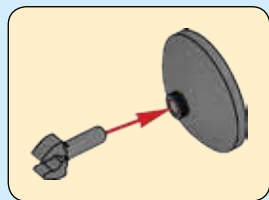

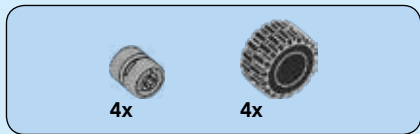

86

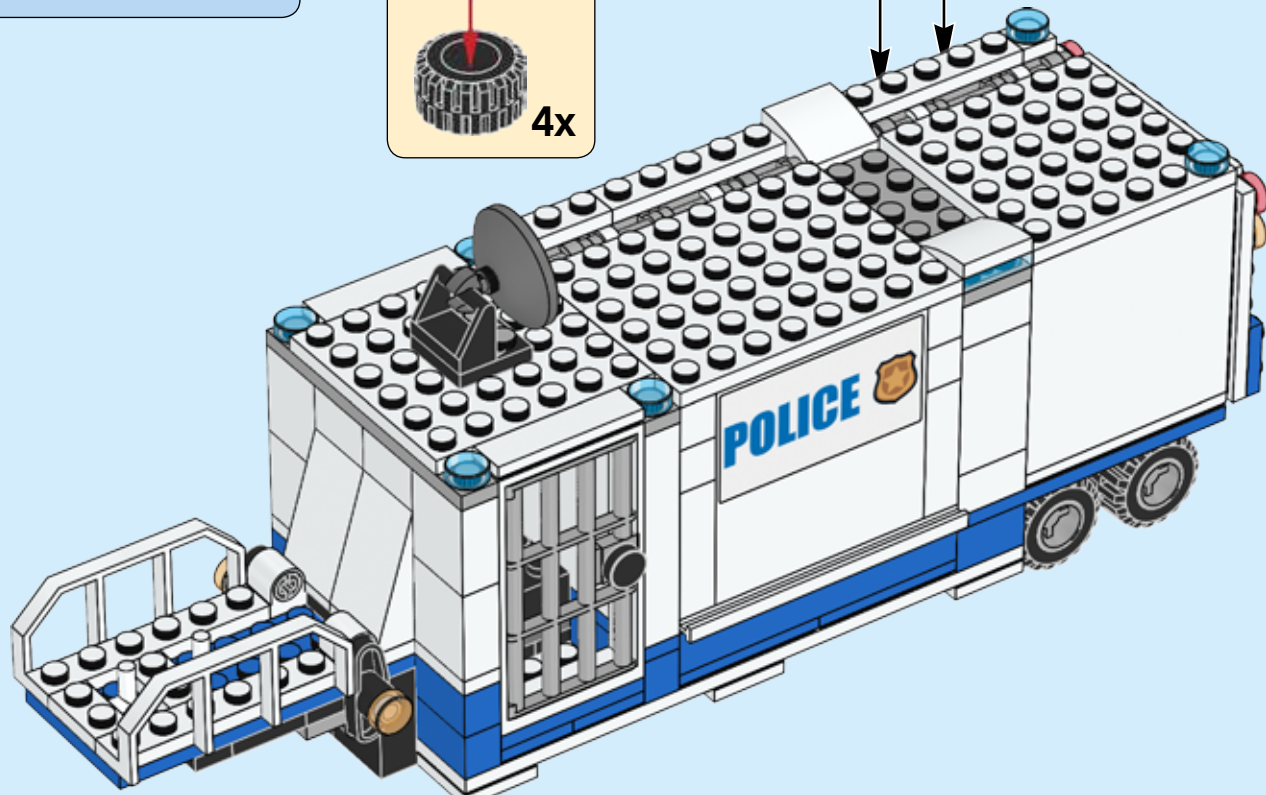
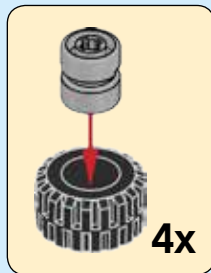

82



87

