



LEGENDS OF

TM

# CHIMA



70224



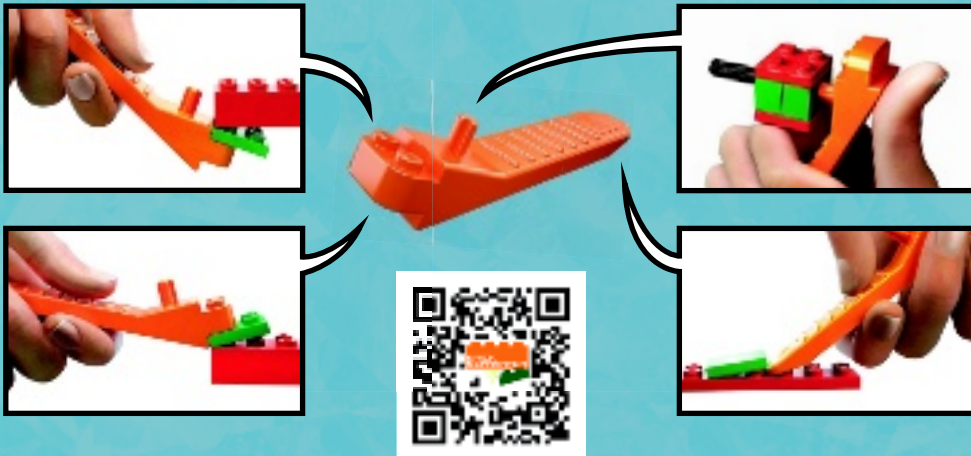





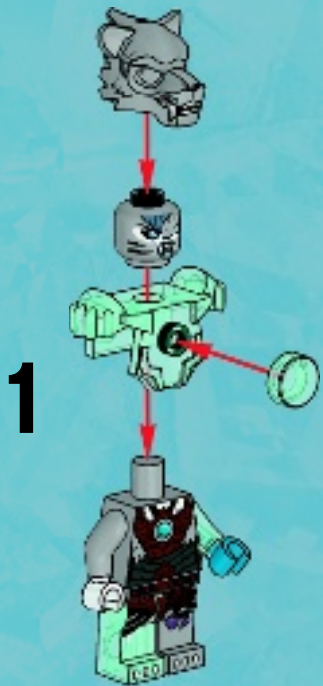
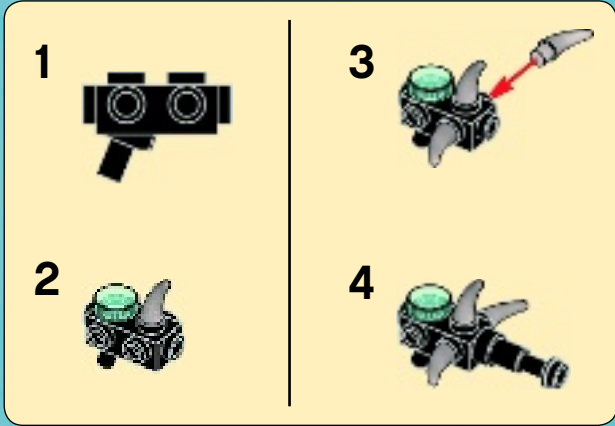
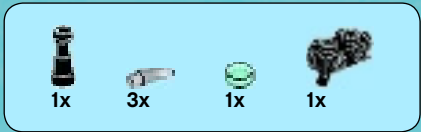



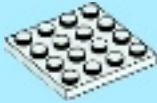

1x

**1**



2x

**2**

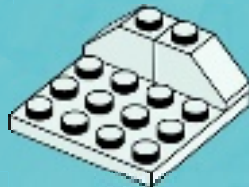

1x



1x

**3**

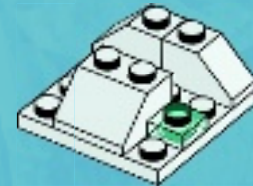

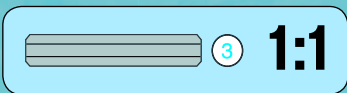
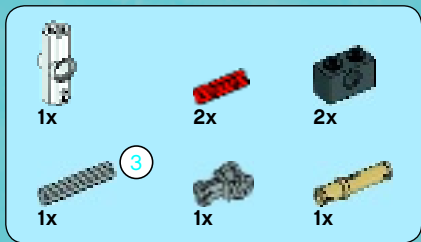

# 4

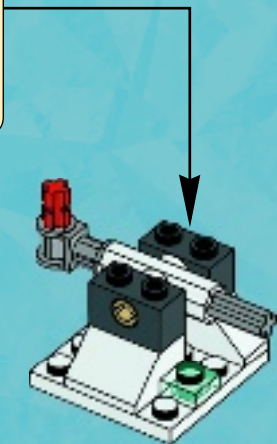
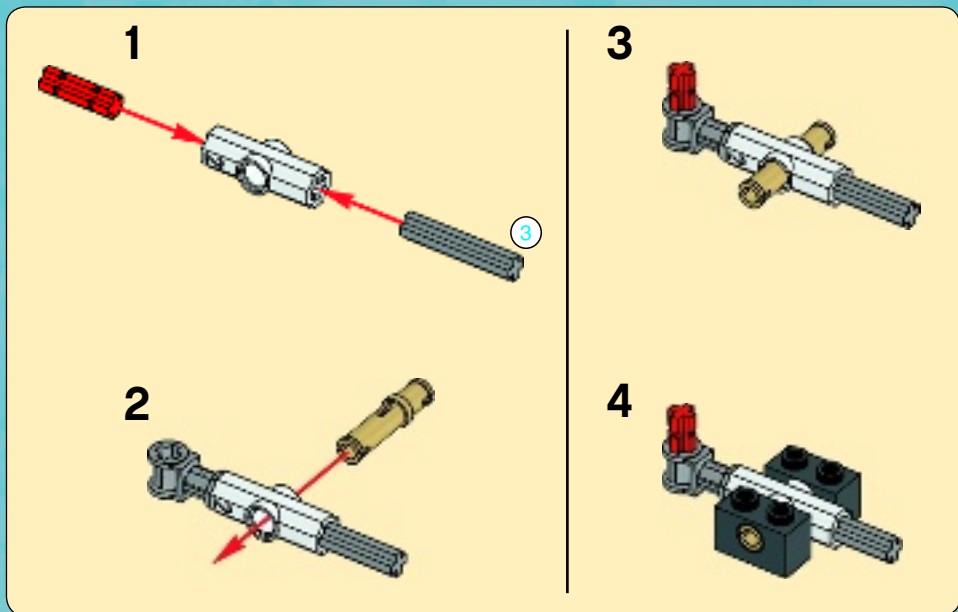



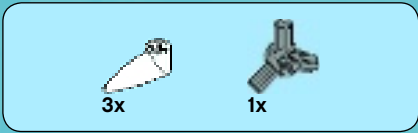

5

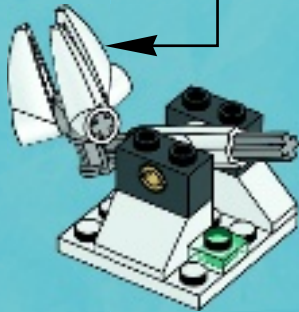
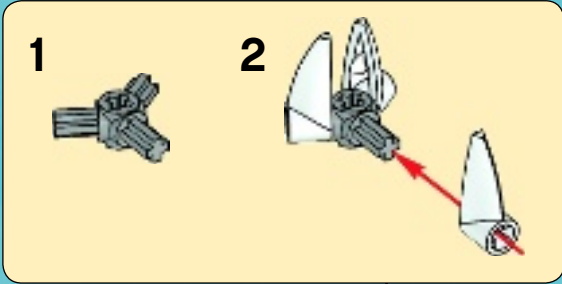

6

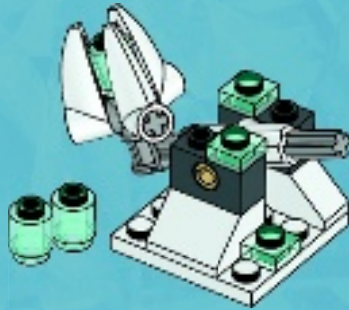

7

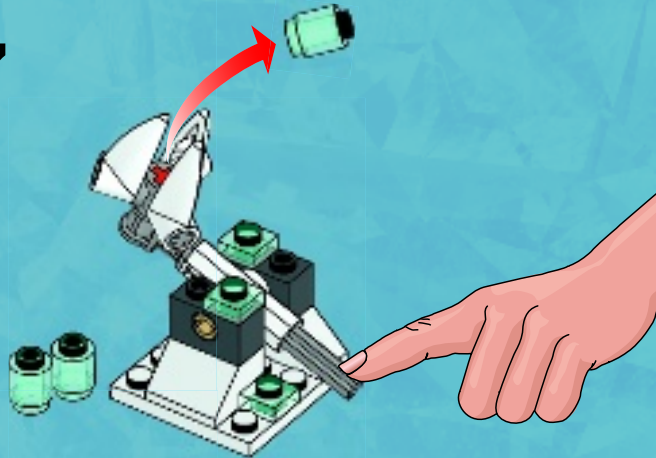

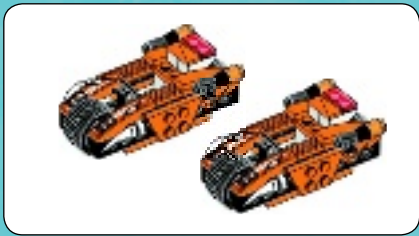

1

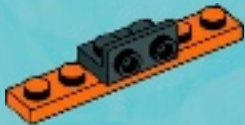

2

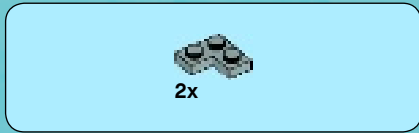
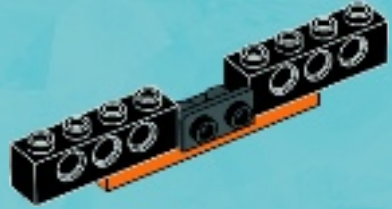

3

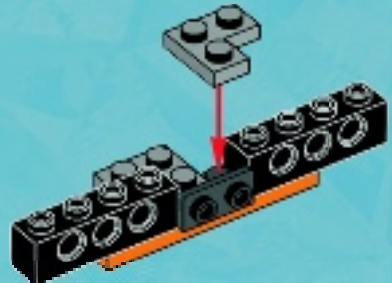





1x

# 4



1x



2x

# 5



2x

# 6





1x

7



2x



2x



2x

8

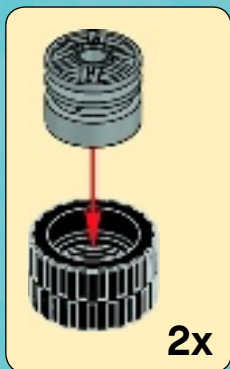
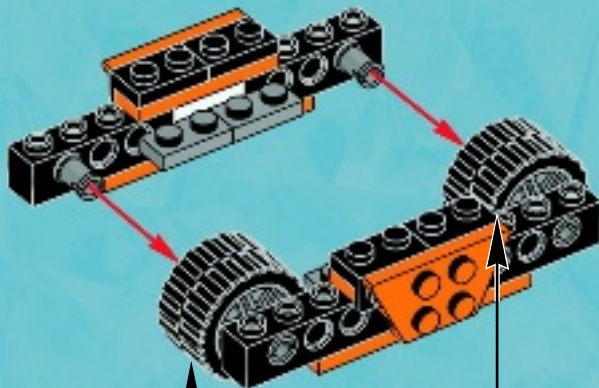

2x





1x



# 9



1x



1x

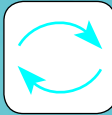

# 10

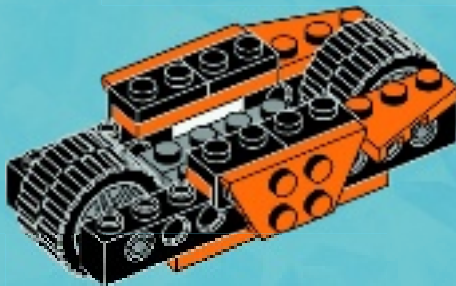

2x



2x

# 11





1x



2x

# 12

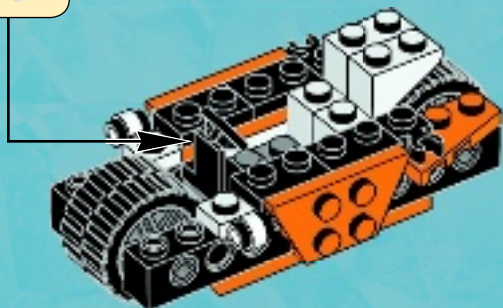

1x



2x



2x

# 13

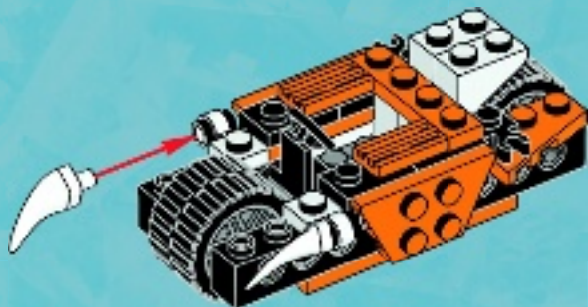

4x

# 14

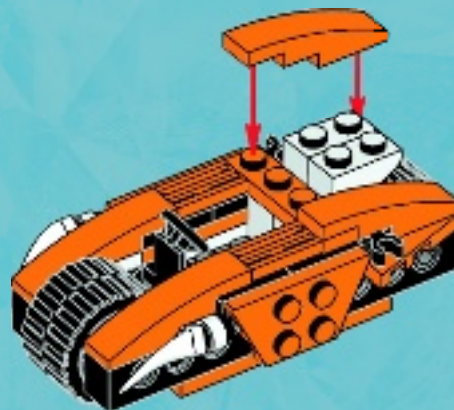



2x



2x

# 15



2x

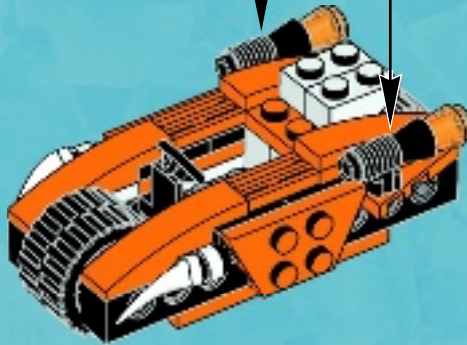

1x



1x

# 16



2x



# 17

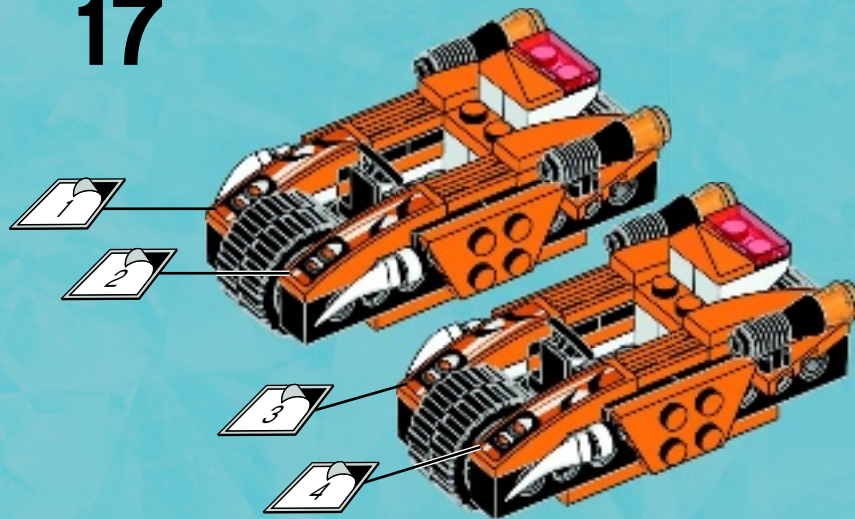

# 18

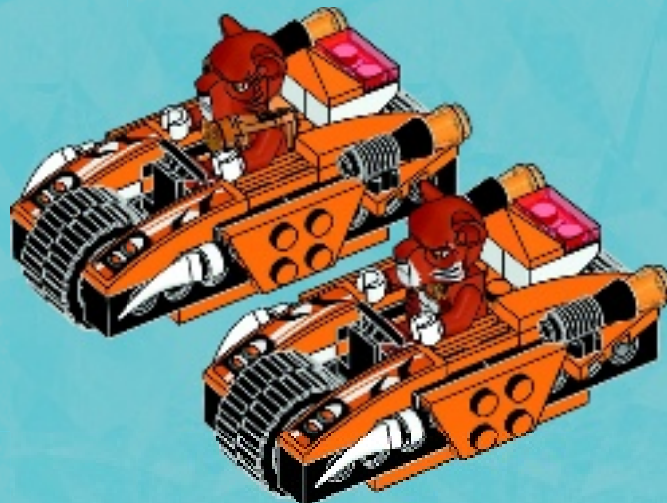

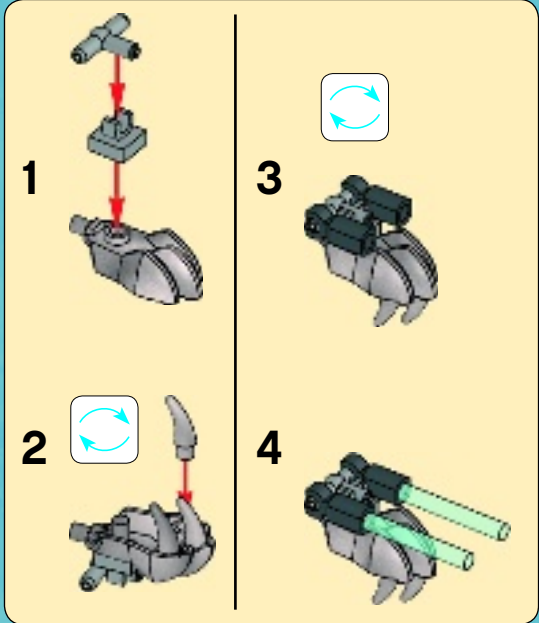
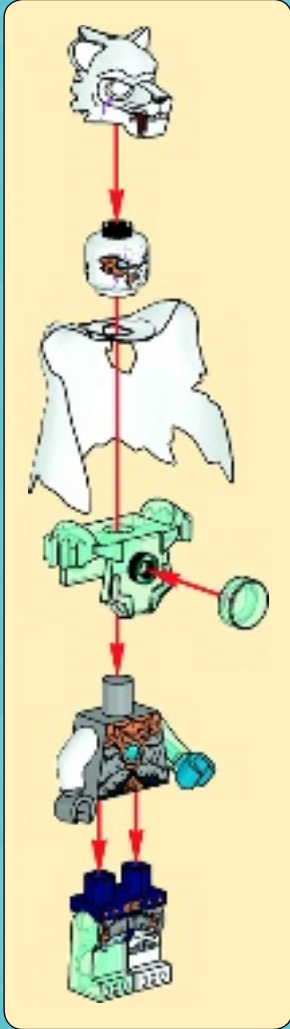
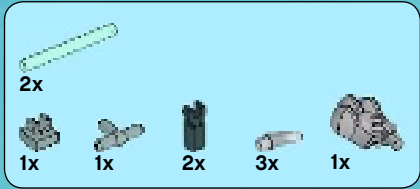
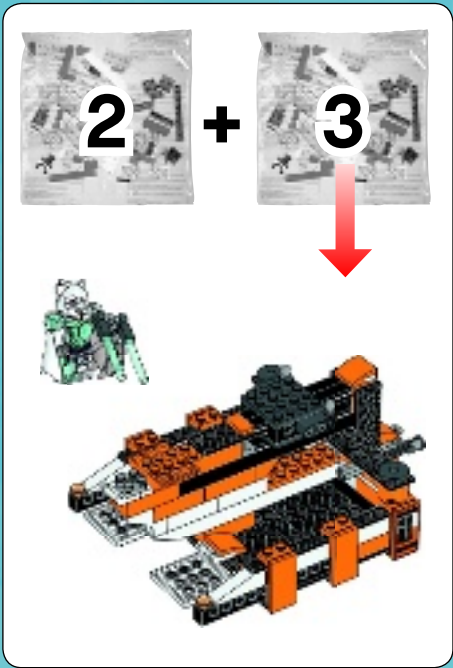

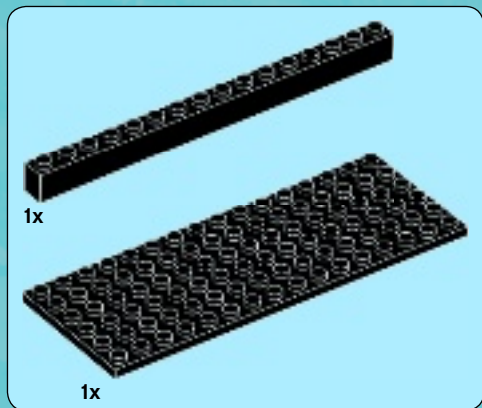

1

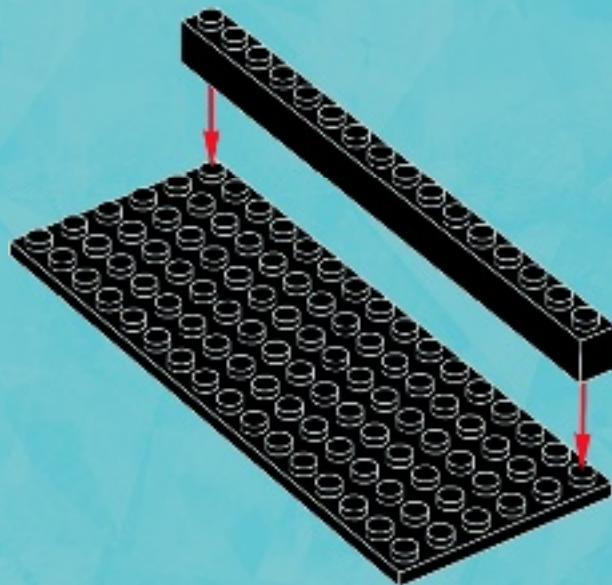



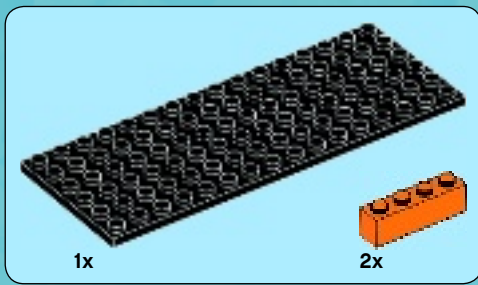

2

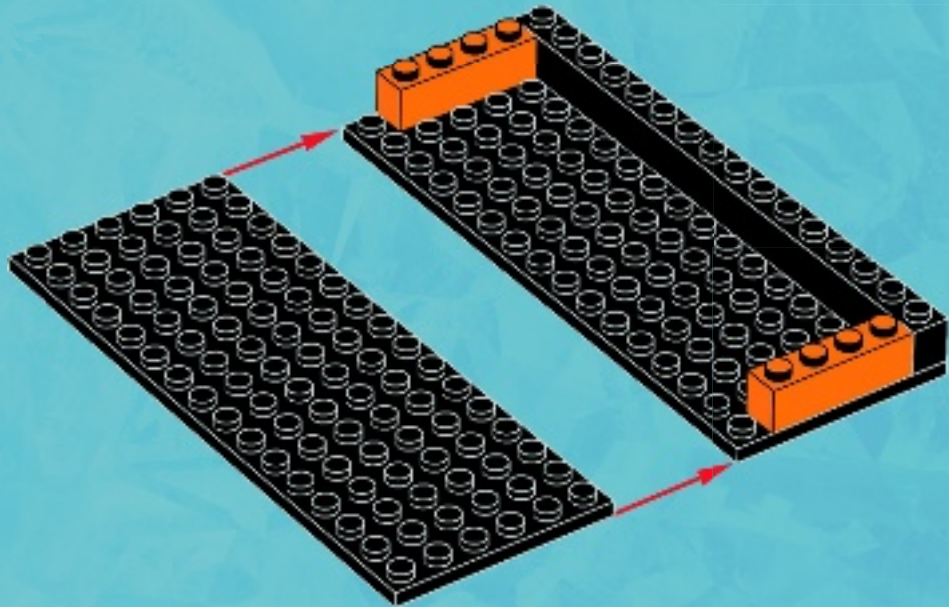

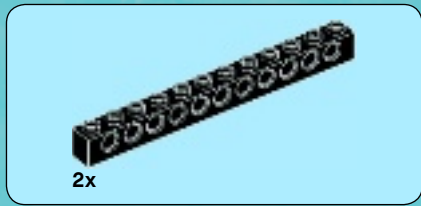

3

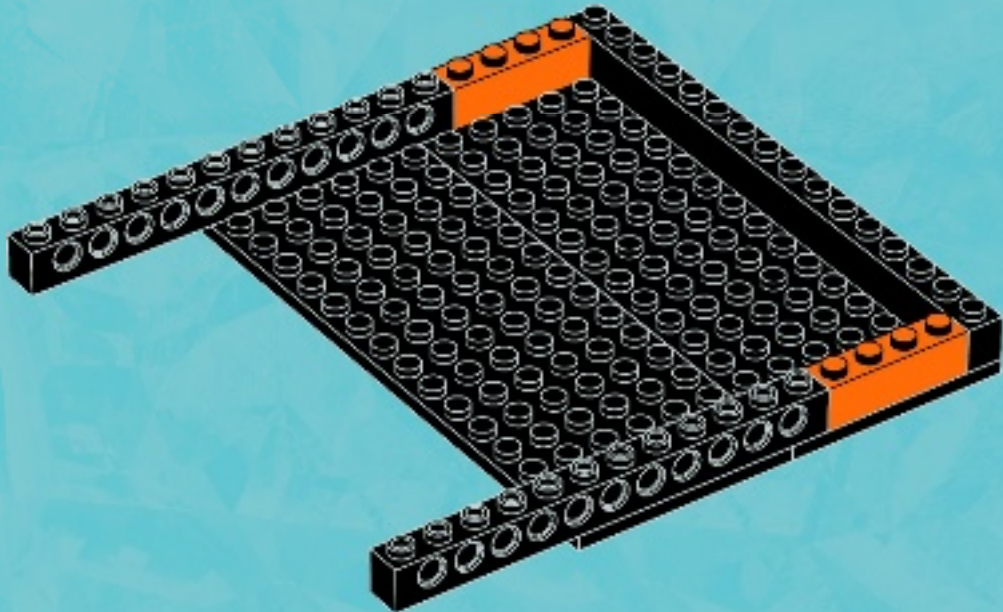

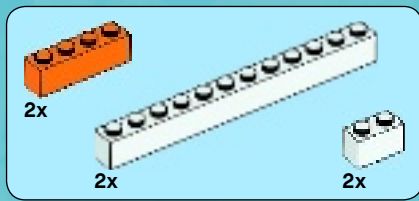

4

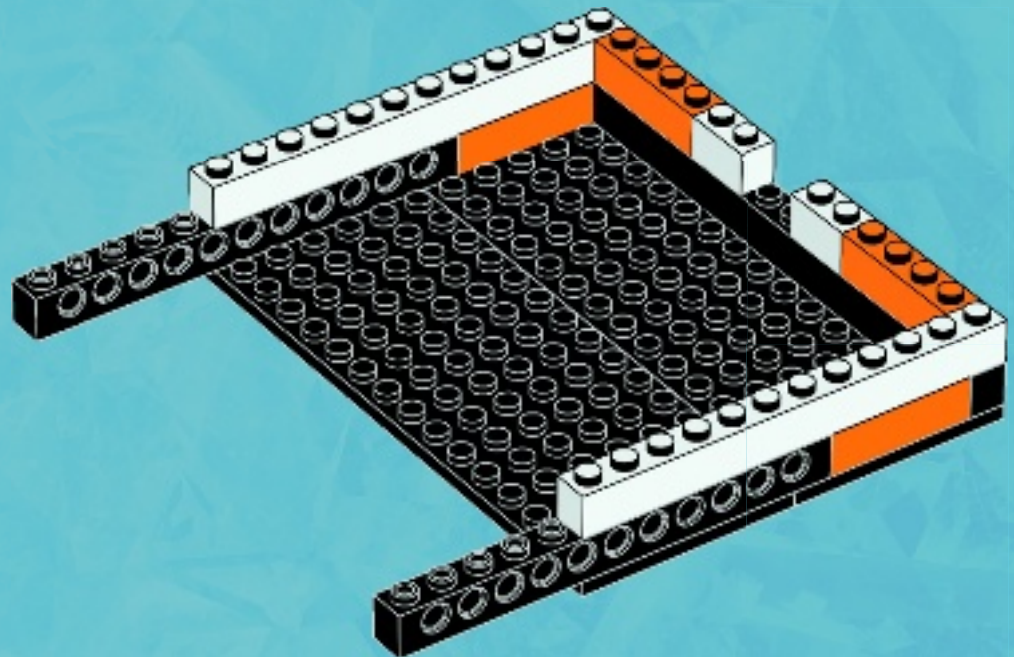





4x

5

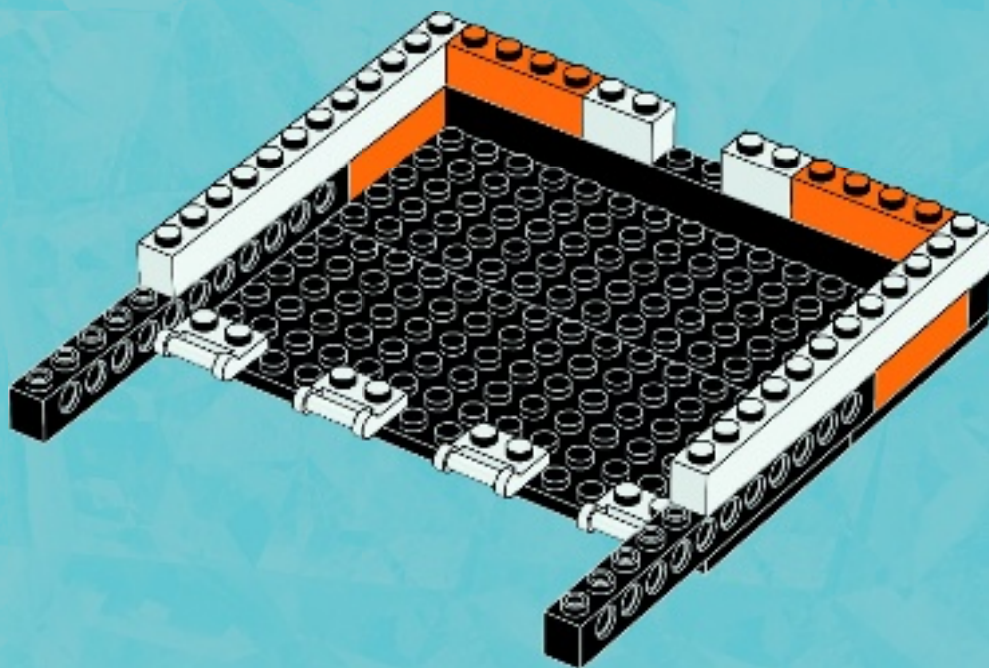



4x

6

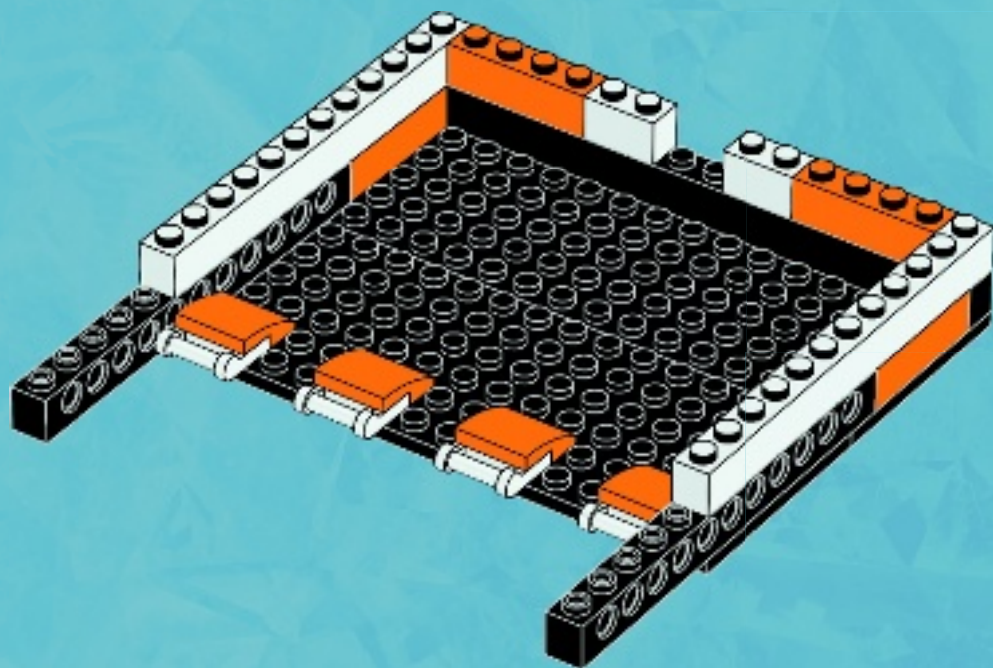

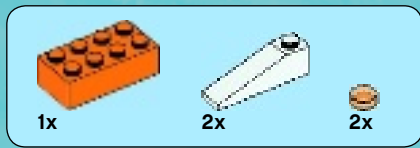

7

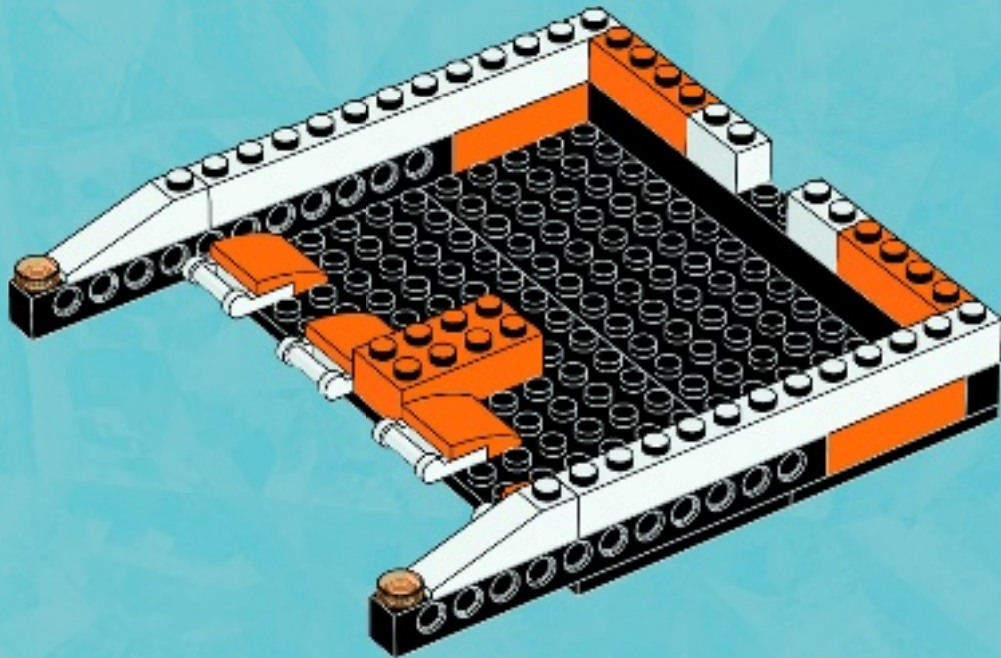





6x

8

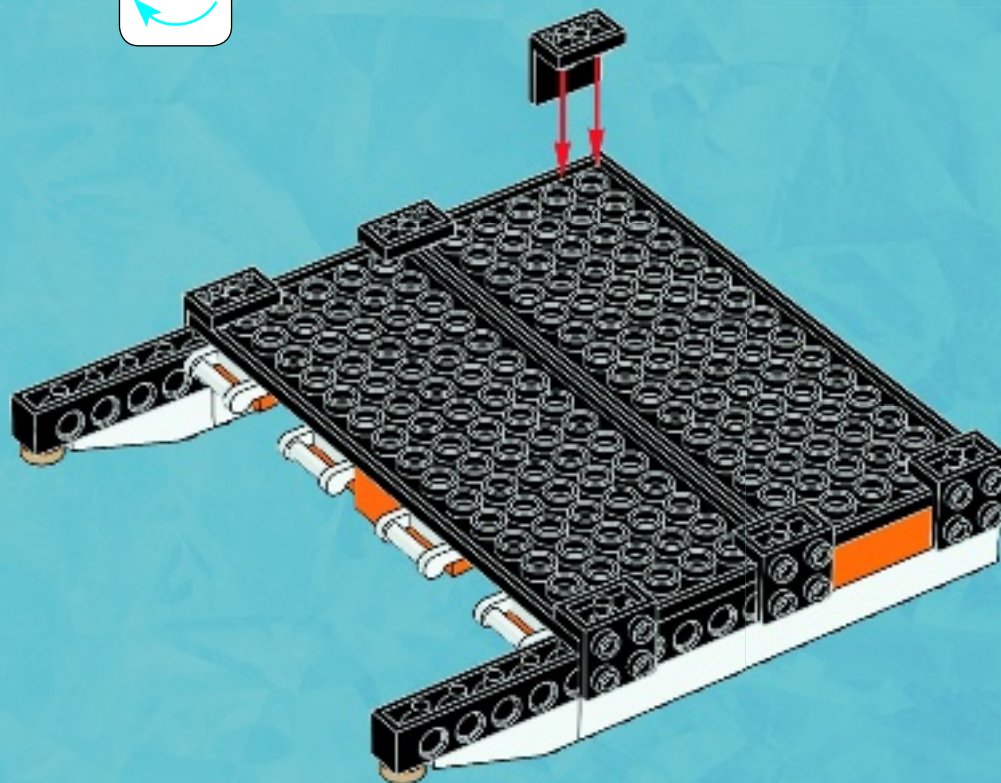

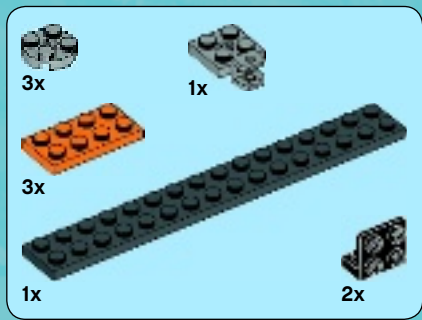

**9**

**1**



**2**



**3**



**4**

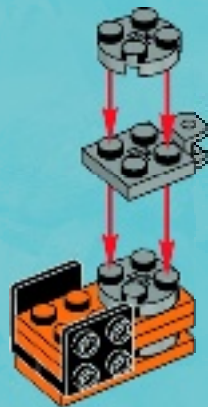

**5**

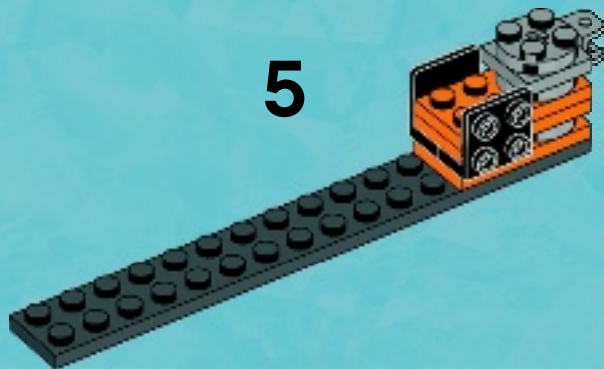

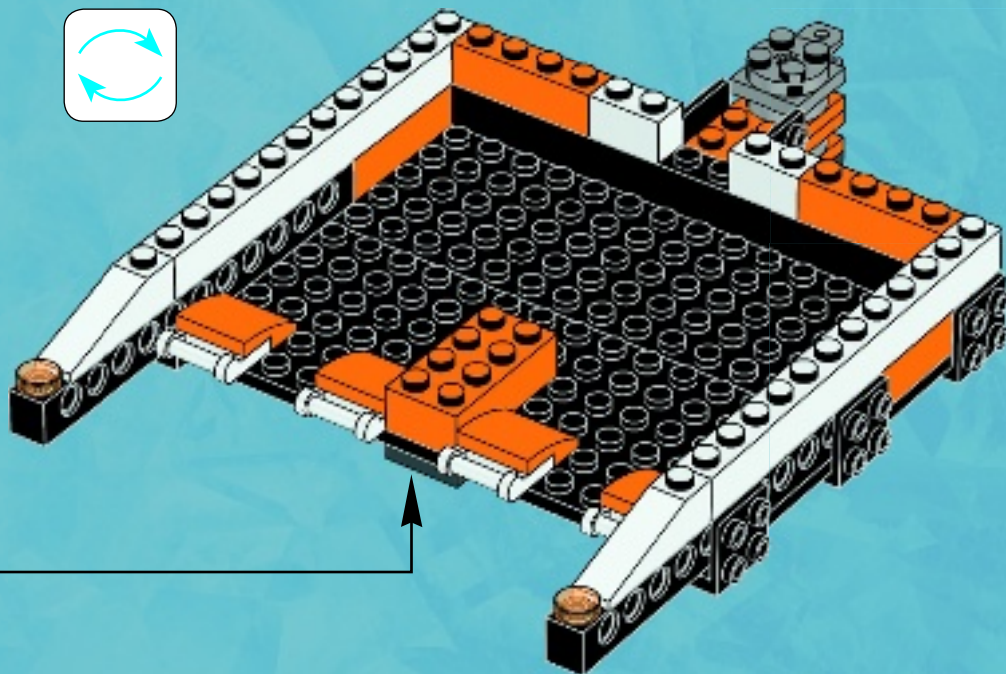



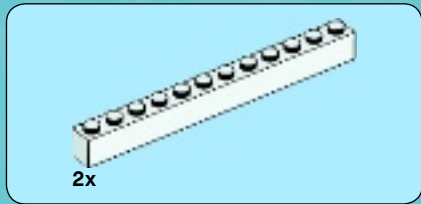

10

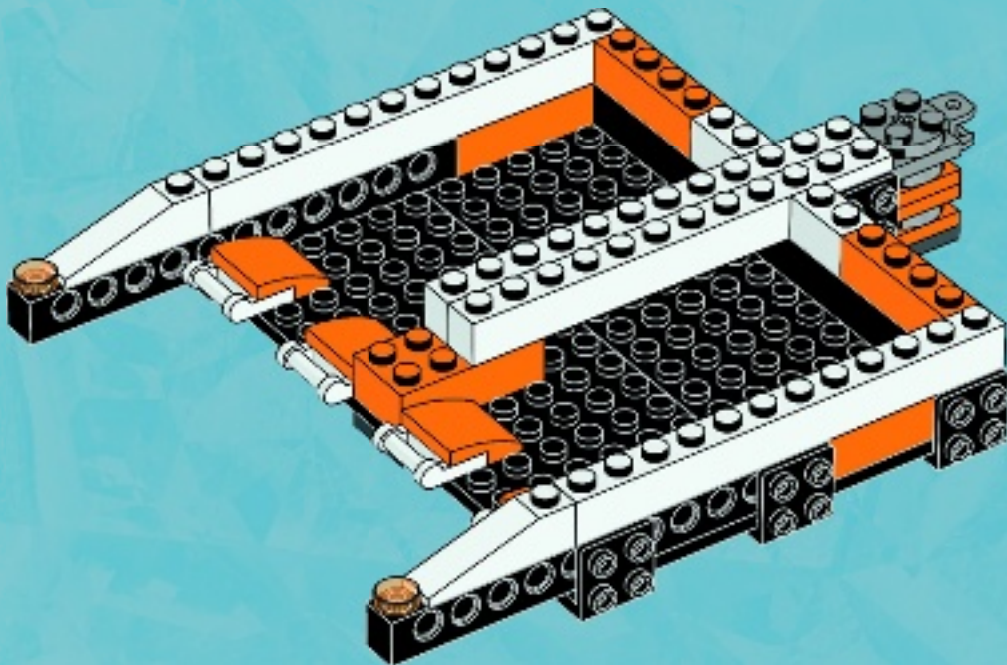



2x

# 11

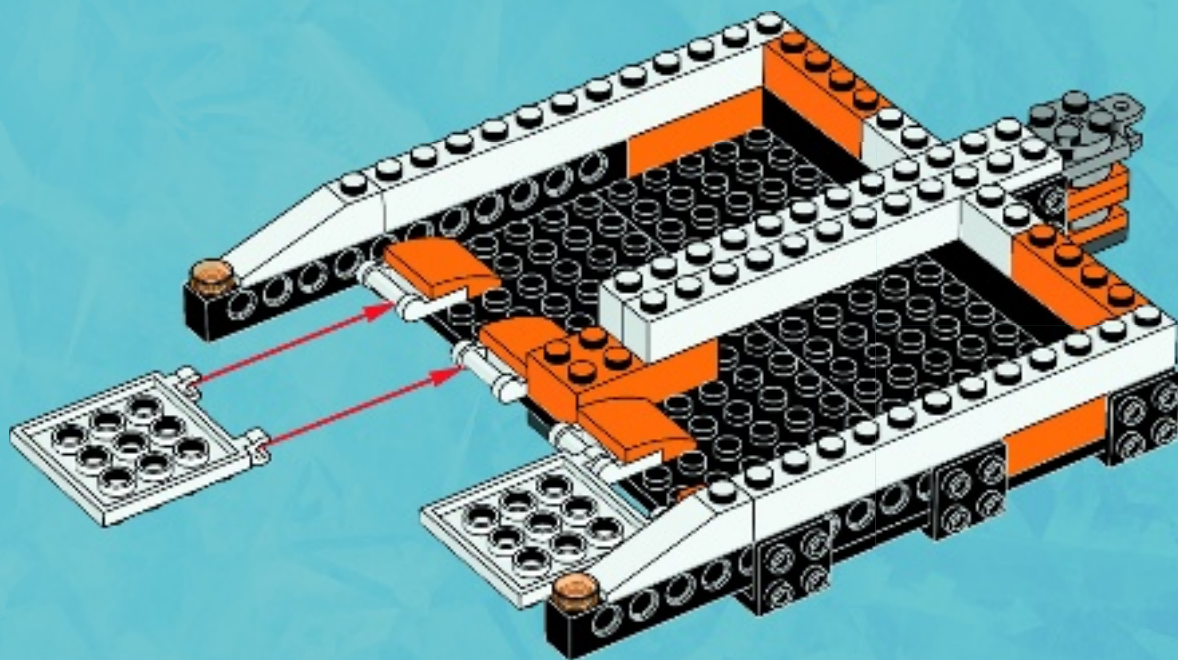

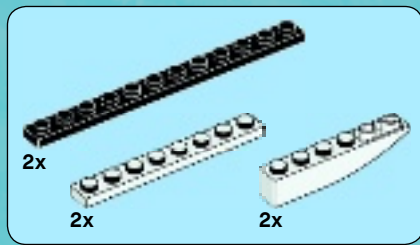

# 12

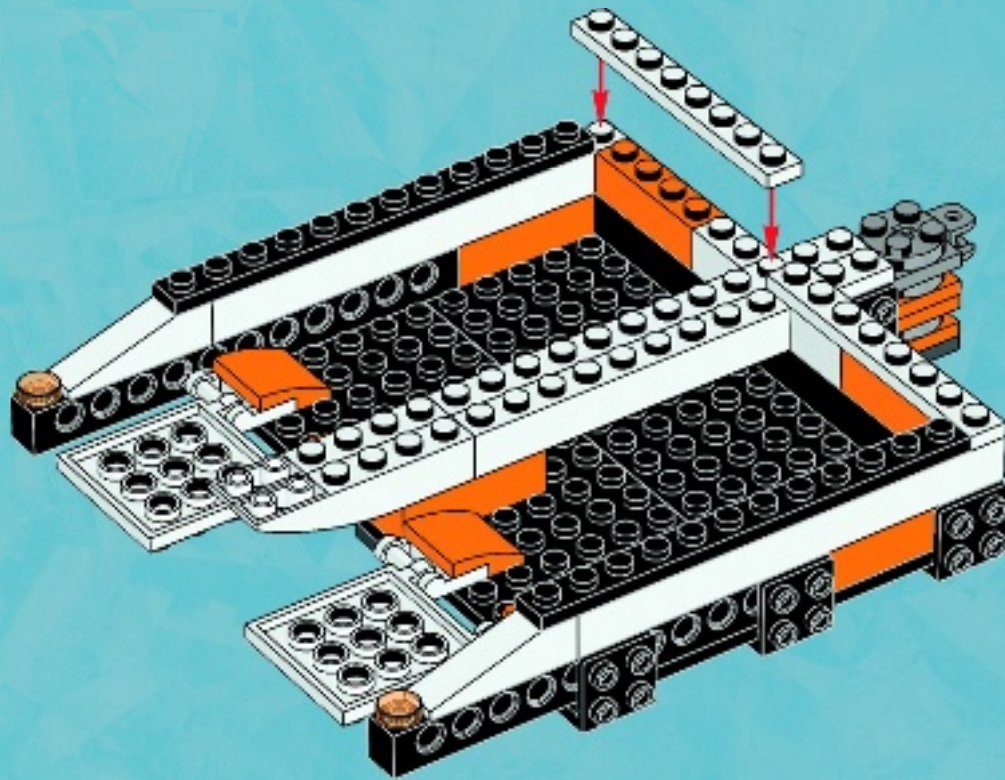





2x



6x

# 13

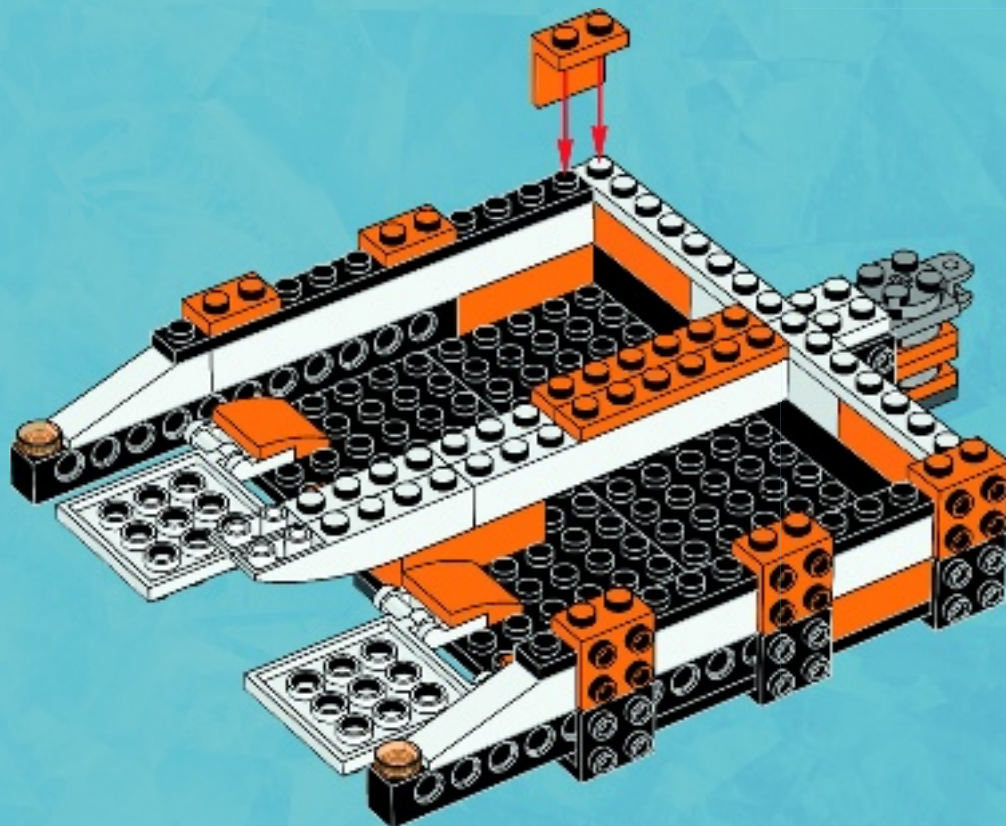

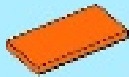

6x

# 14

1

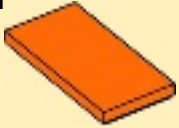

2

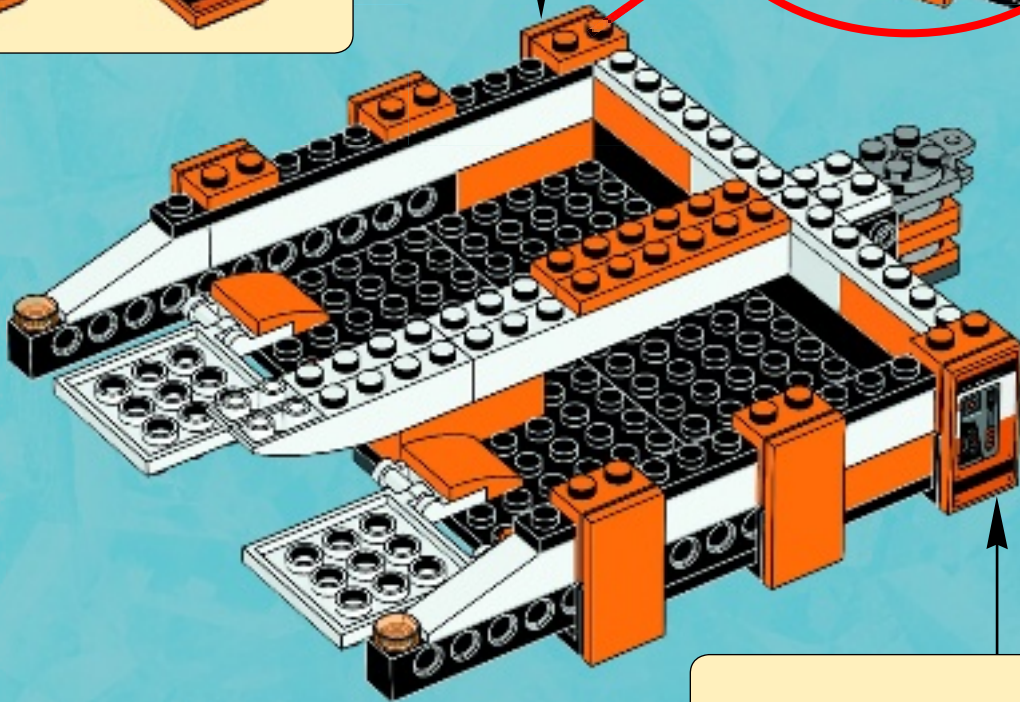
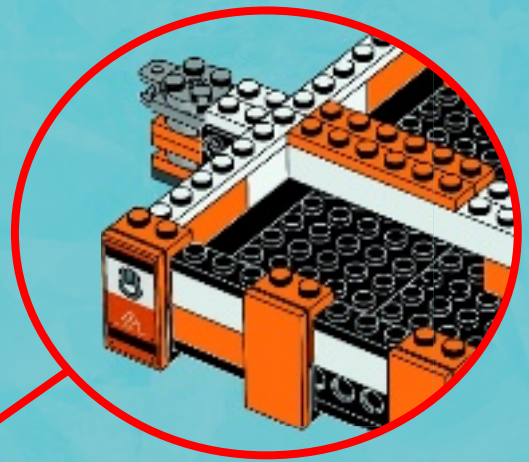
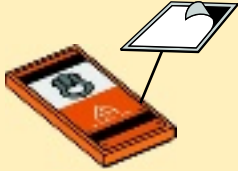

1

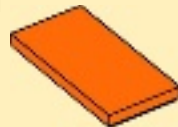

2





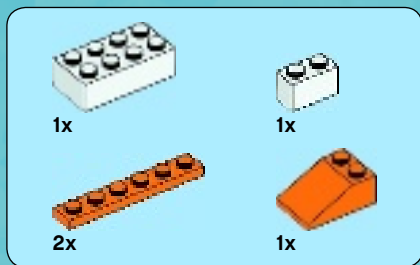

15

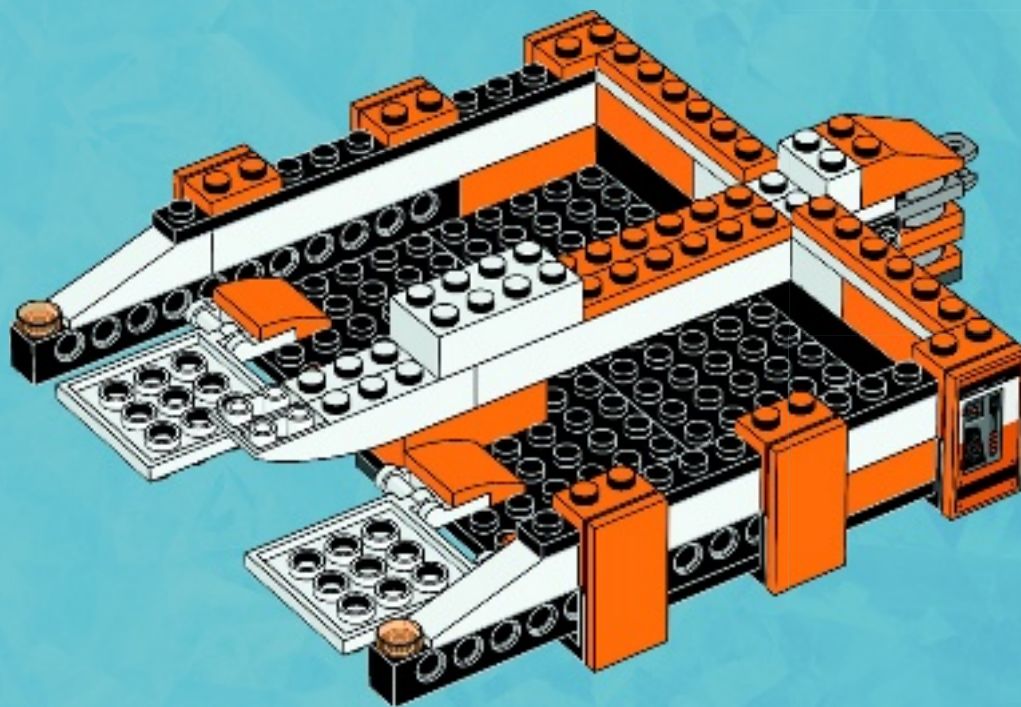





16

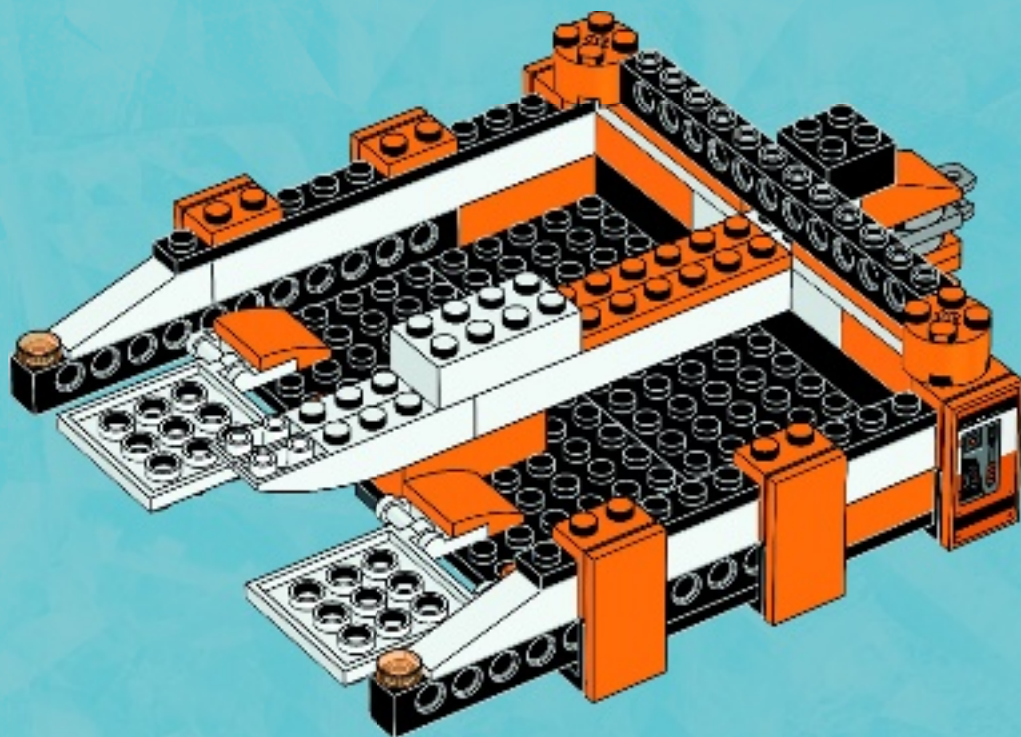

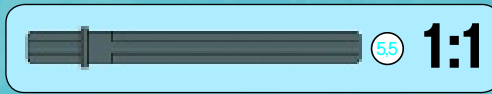
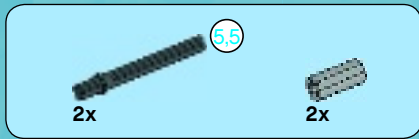

17

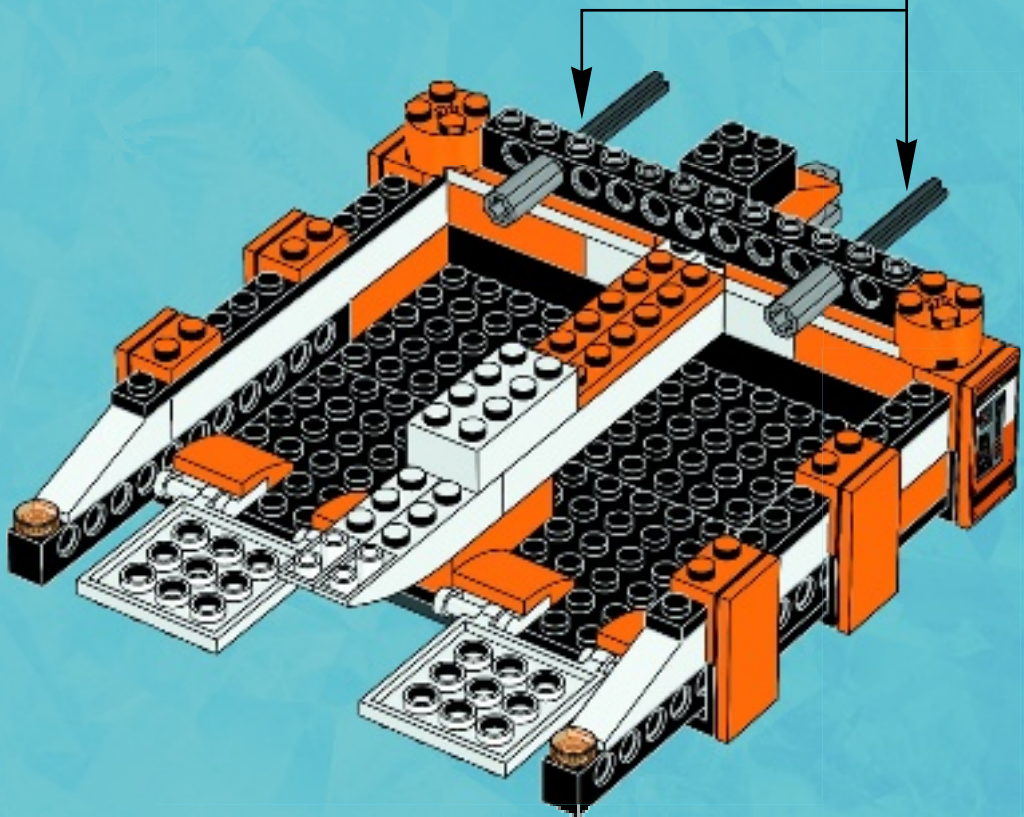
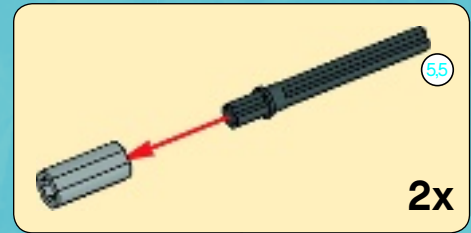





2x

# 18

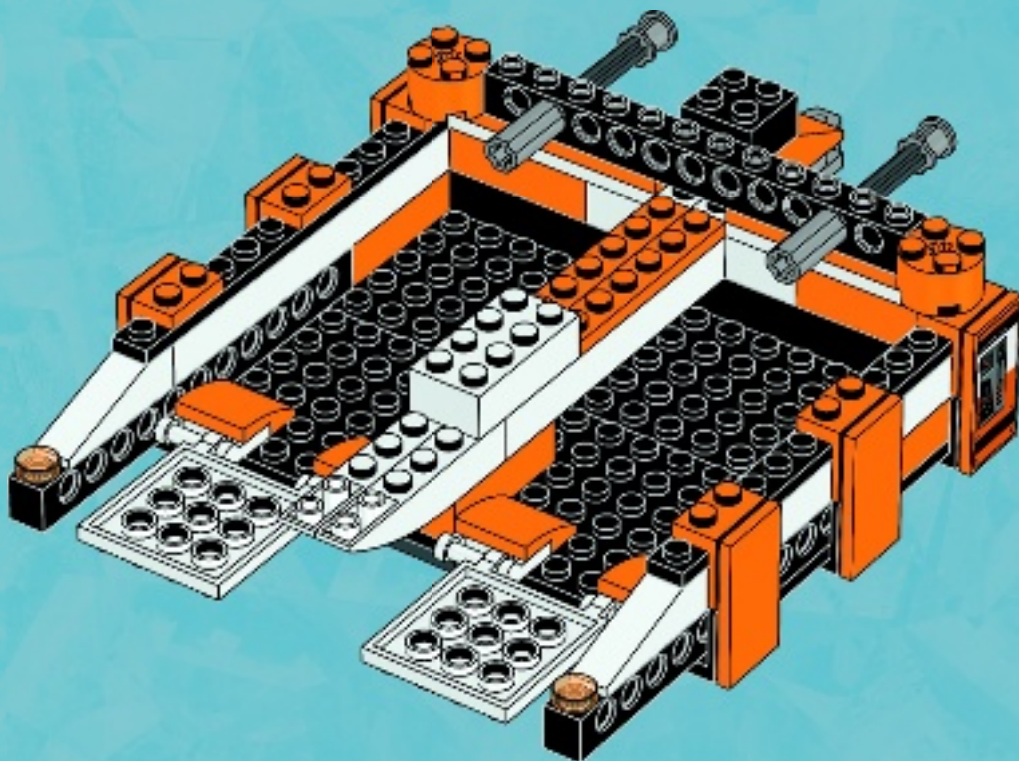





19

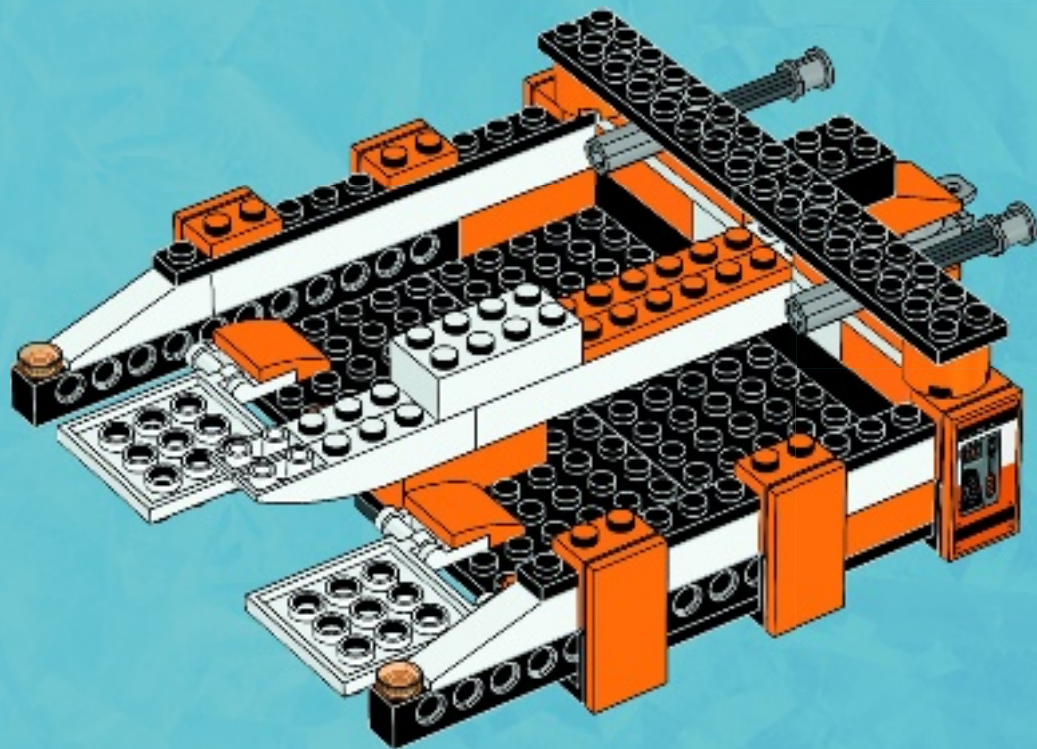



2x

# 20

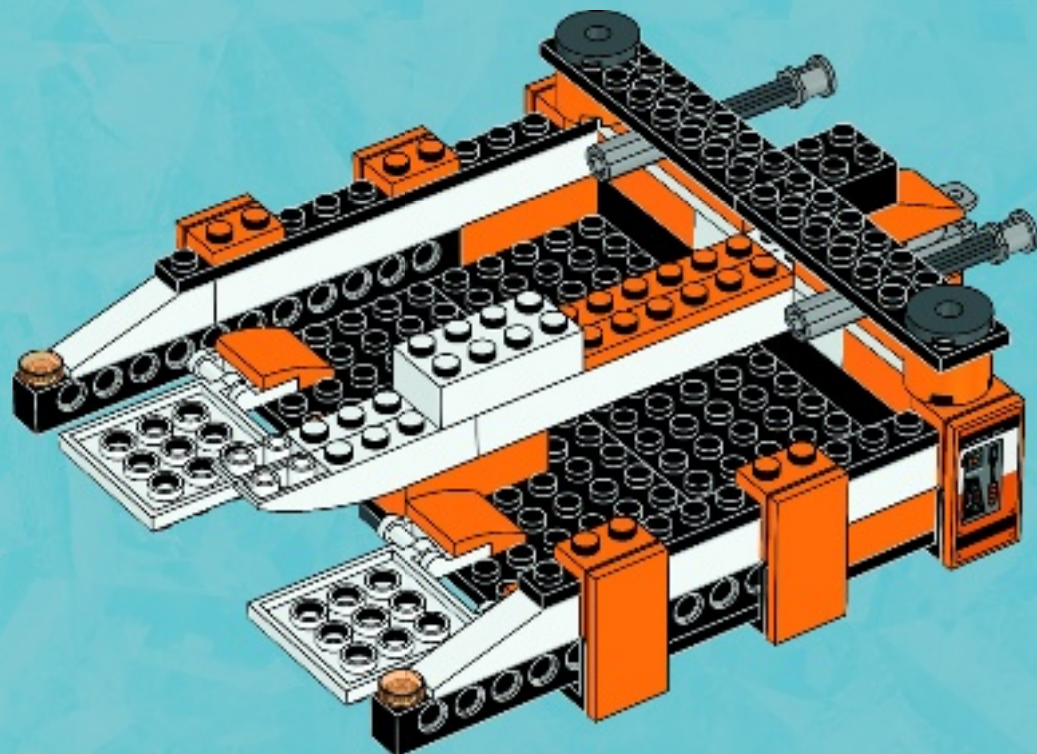





1x



2x

# 21

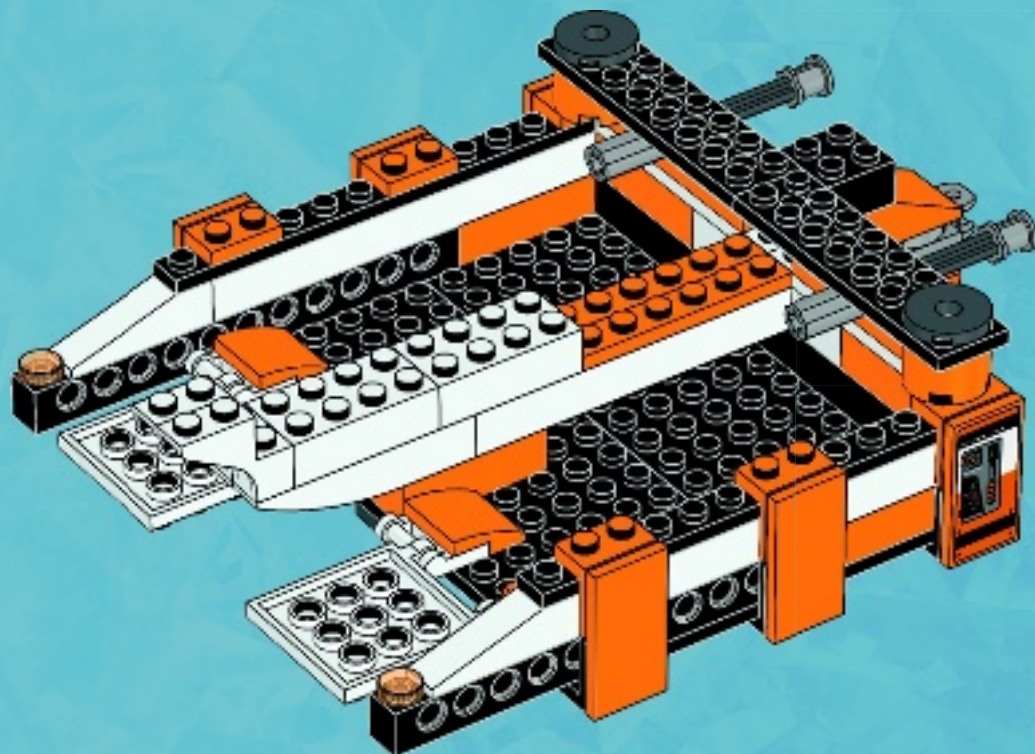





1x

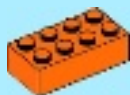

2x

# 22

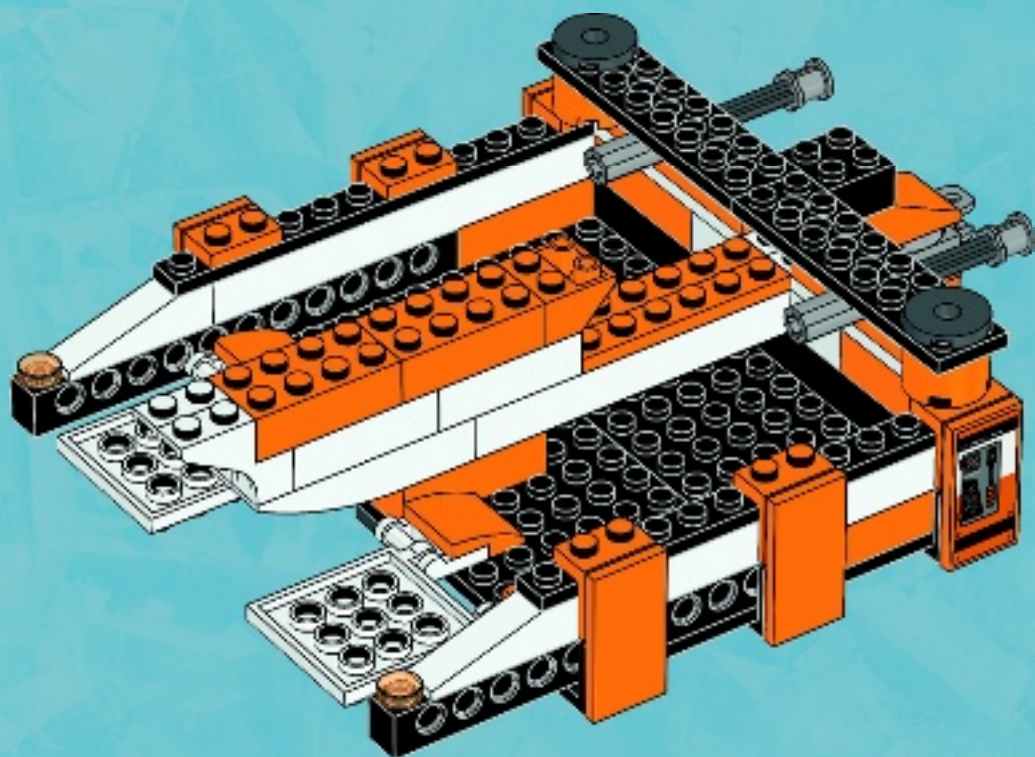

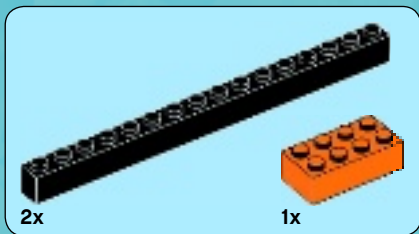

23

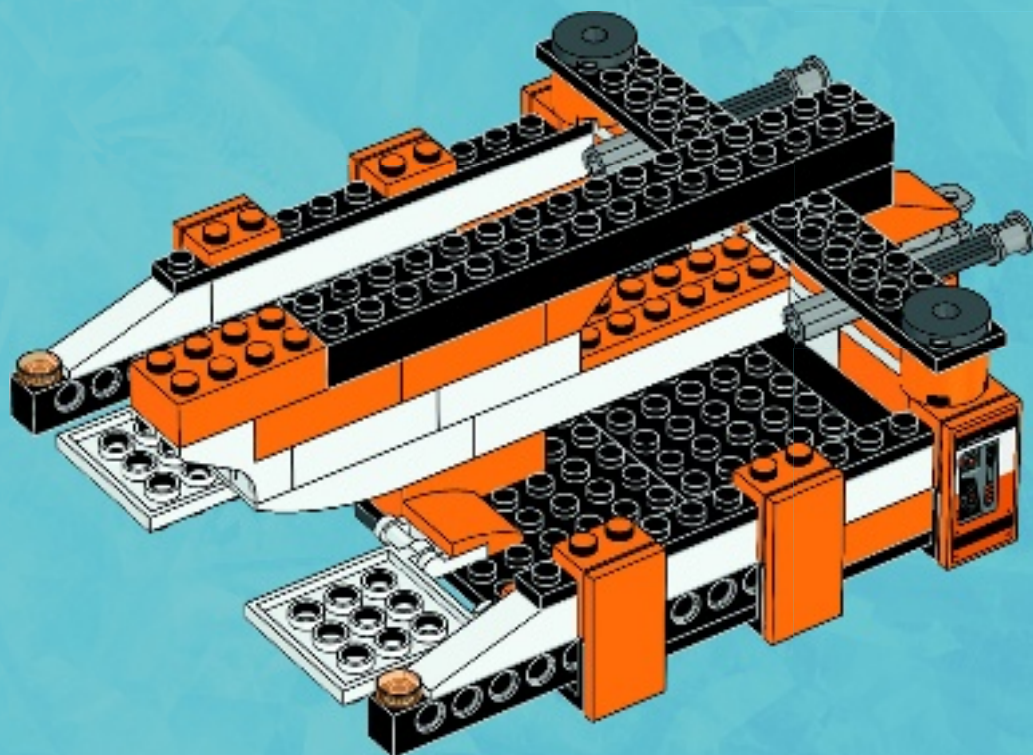



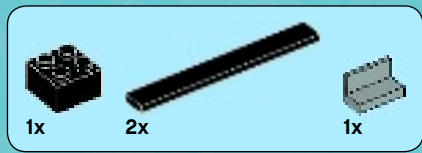

24

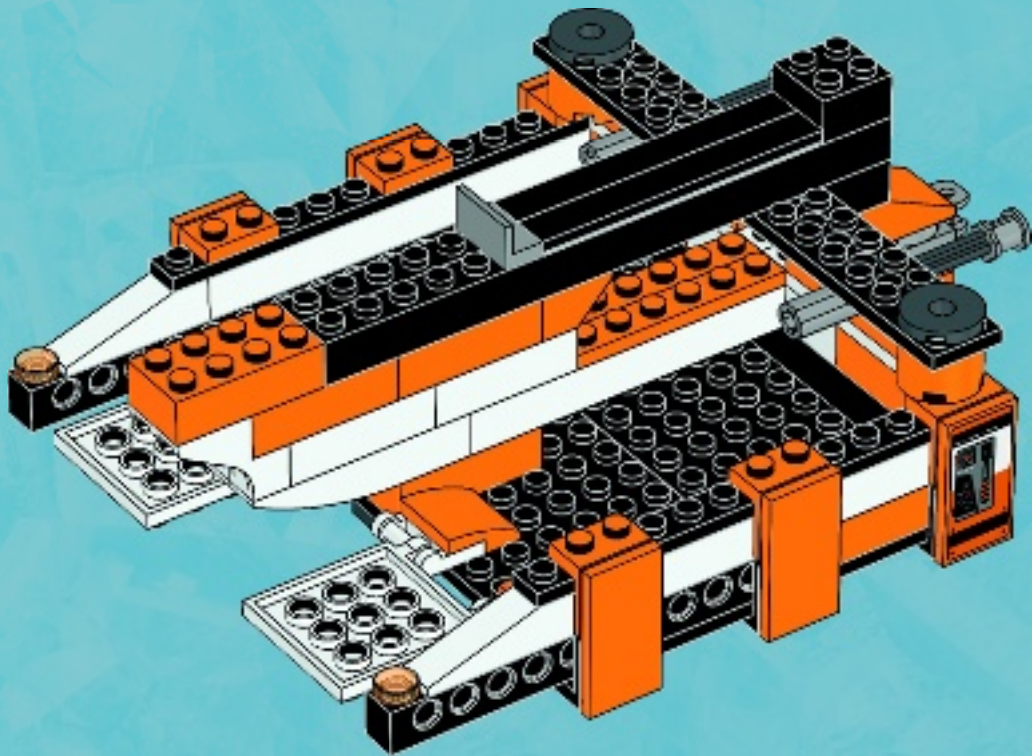





2x

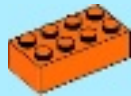

1x

# 25

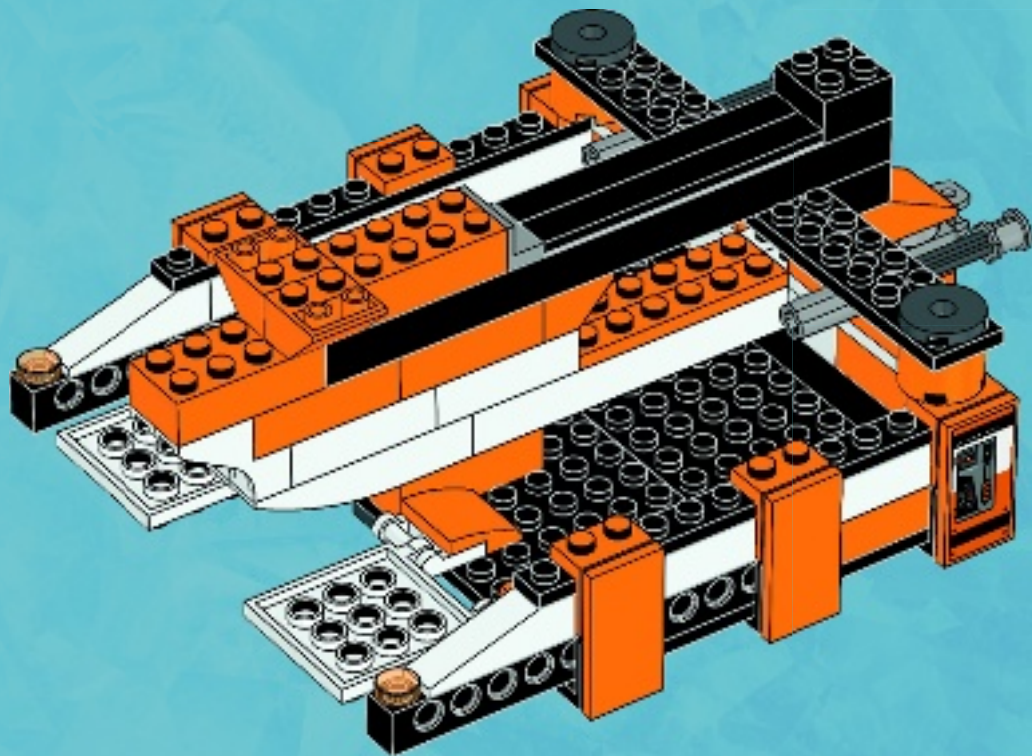



1x



1x

# 26

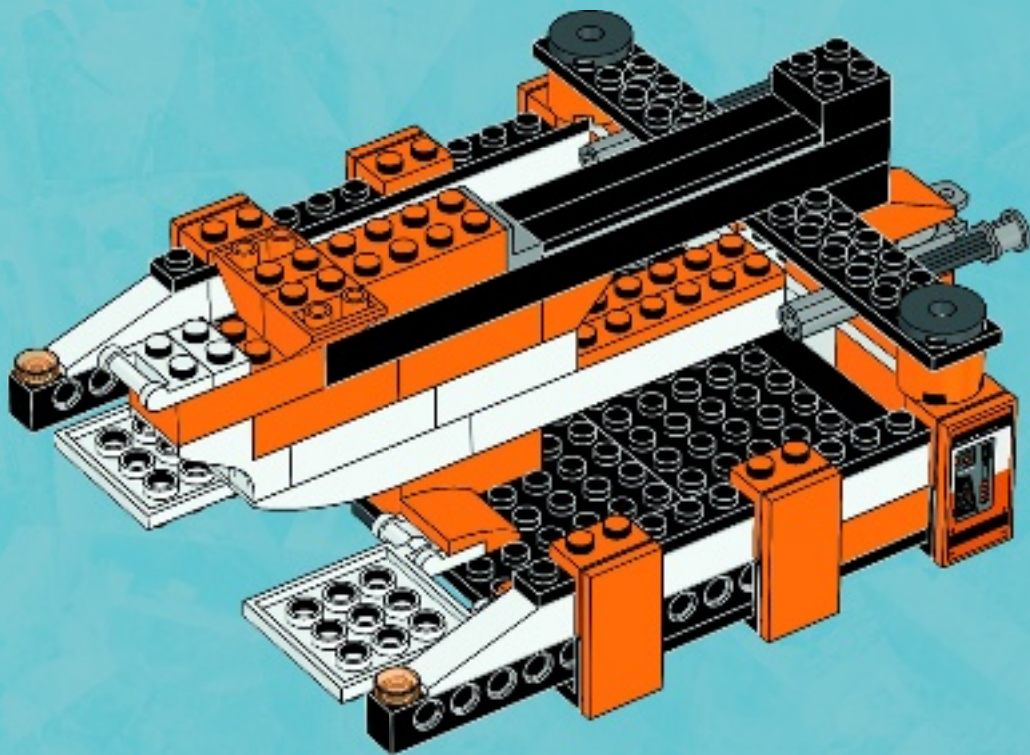



1x



2x

# 27

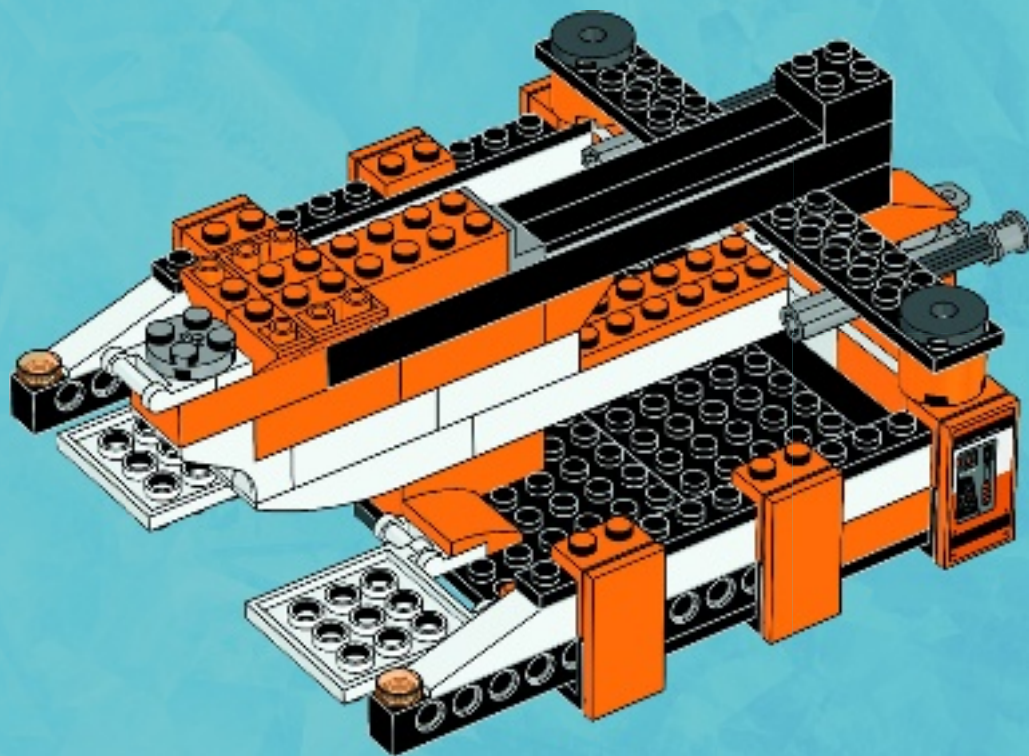



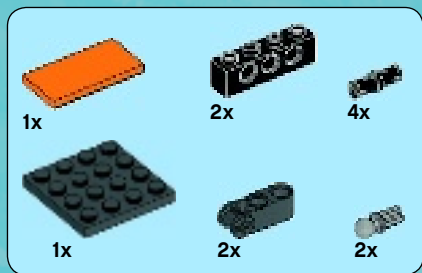

# 28

1



2



3



4

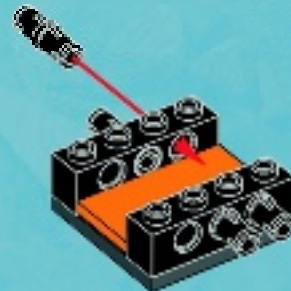

5

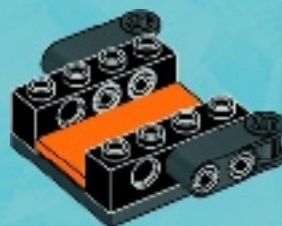

6

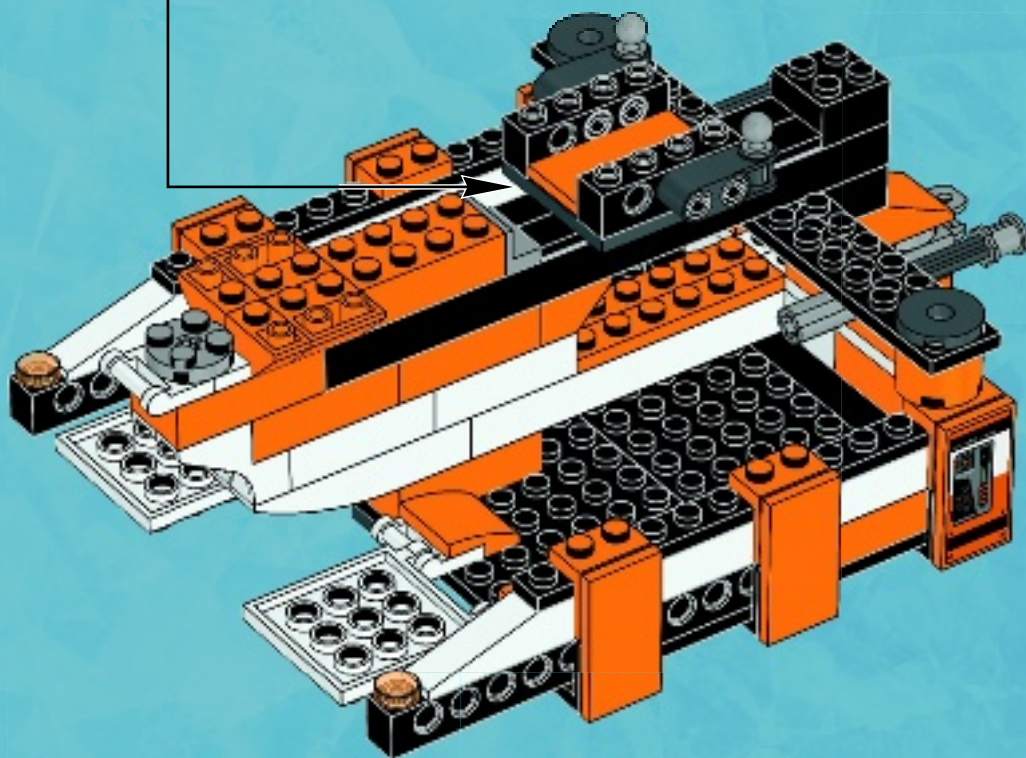
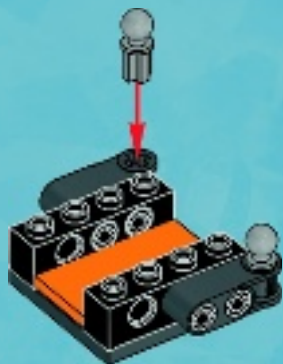



29

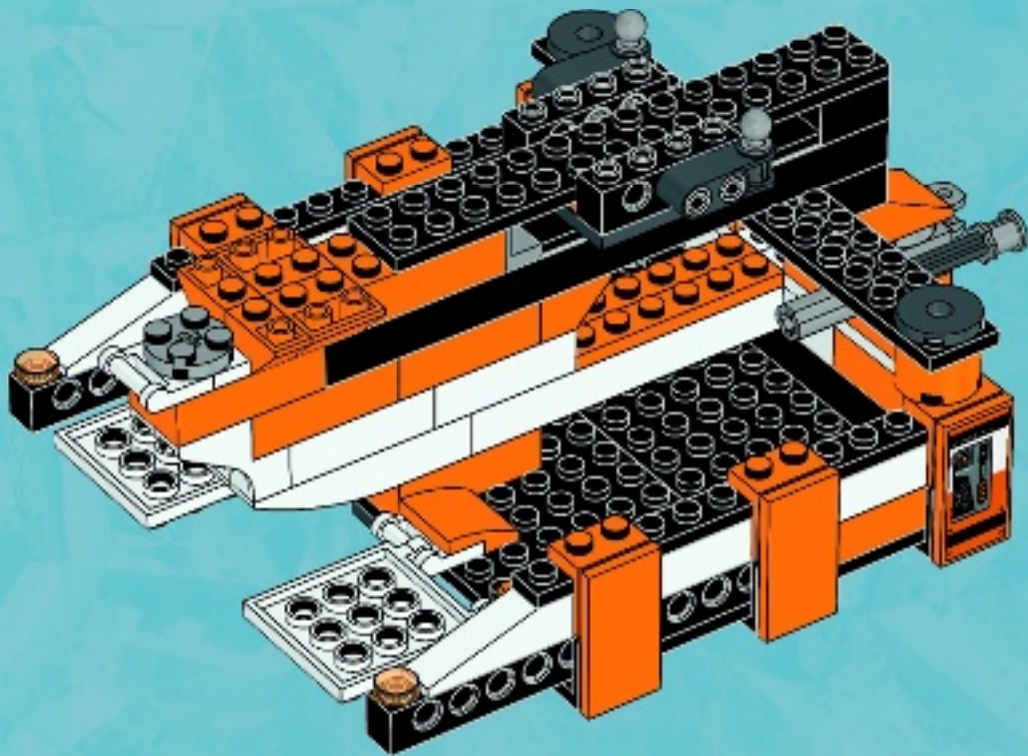



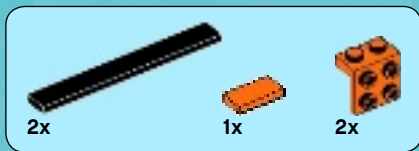

# 30

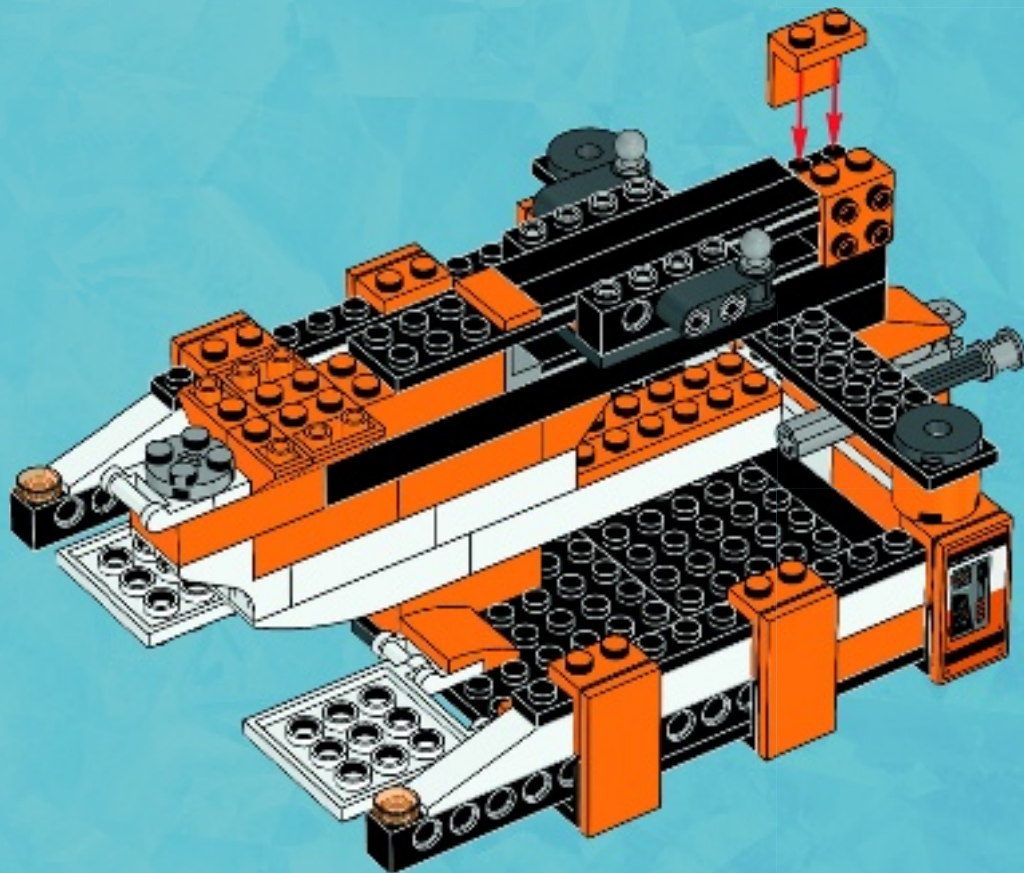

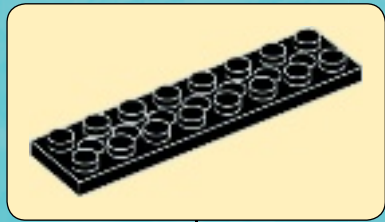
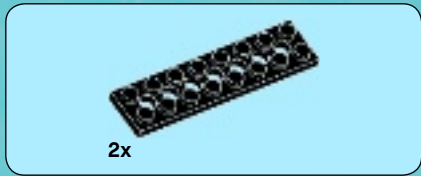

31

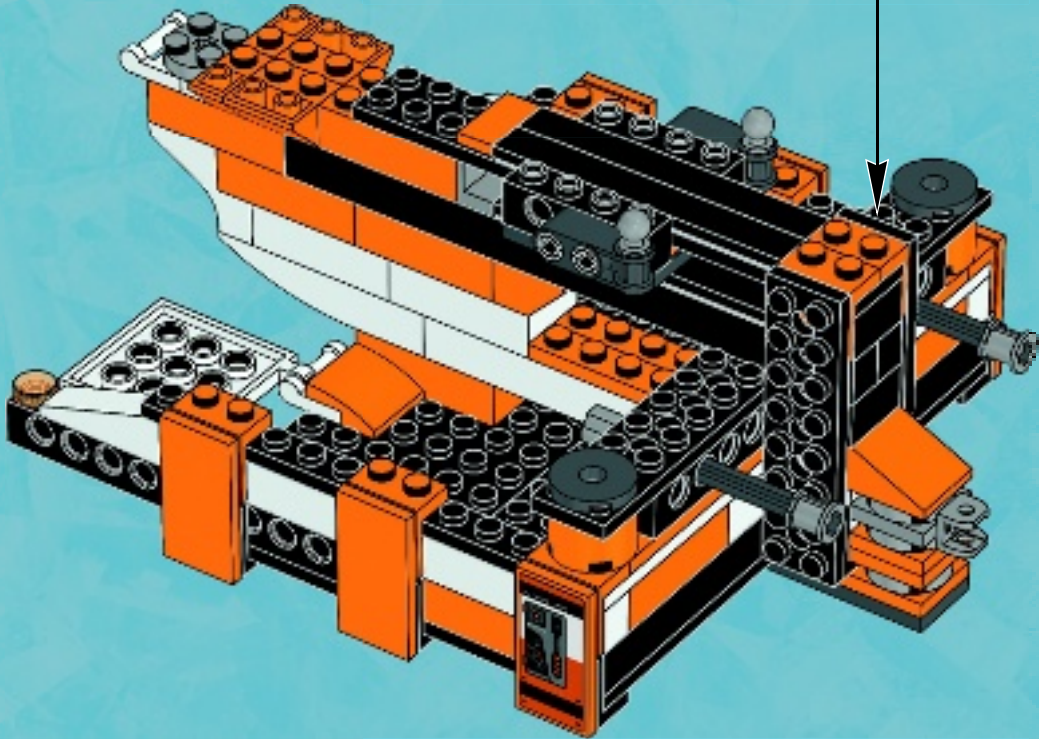





1x



1x

# 32

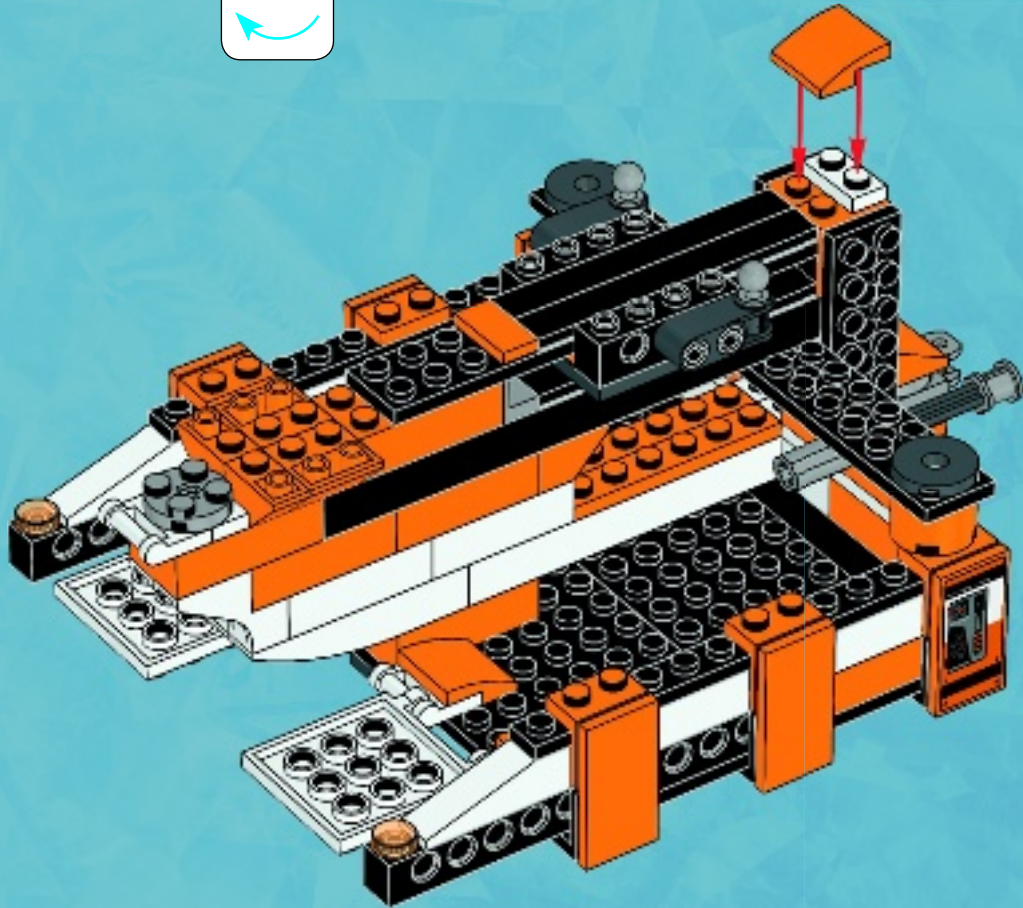





1x

# 33

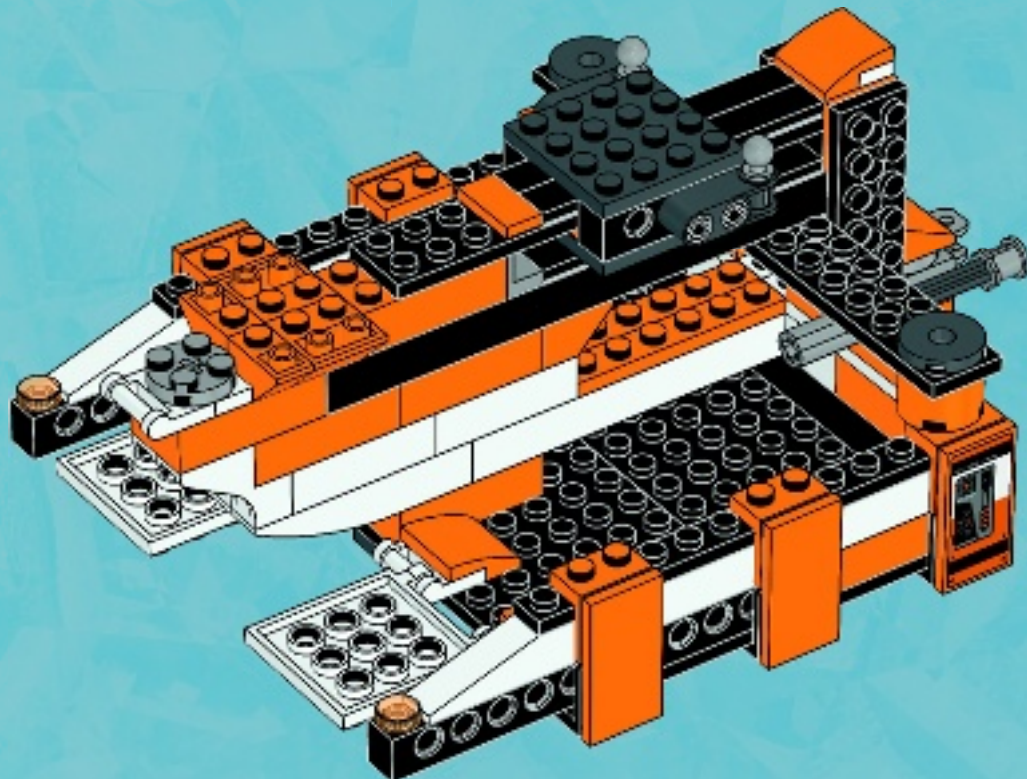



4



2x

34

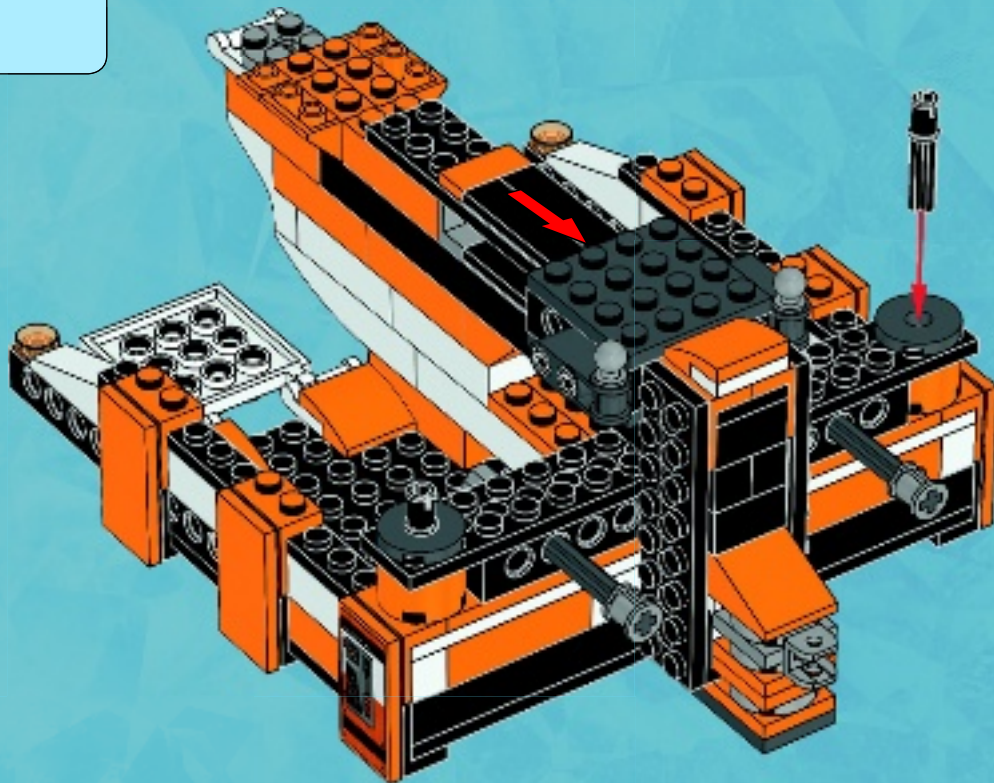



1



2

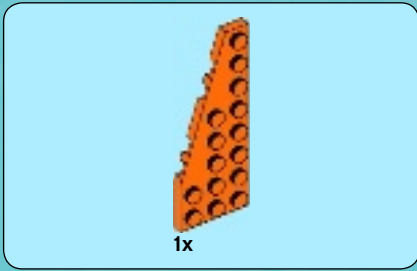

3

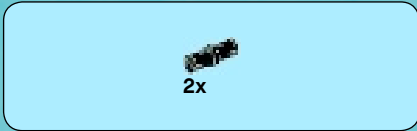

4

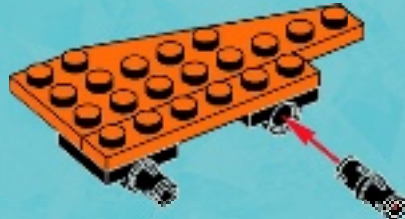





1x

5



1x



1x

6



1x



2x

7

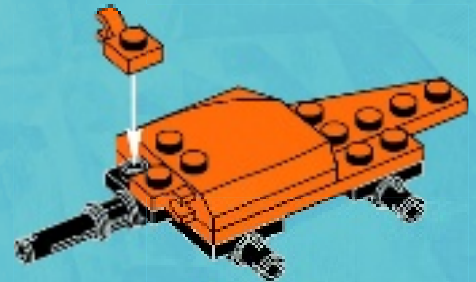



1x

8



1x

9





1x



1x

# 10



1x



1x

# 11







1x

# 12



1x



2x

# 13



35

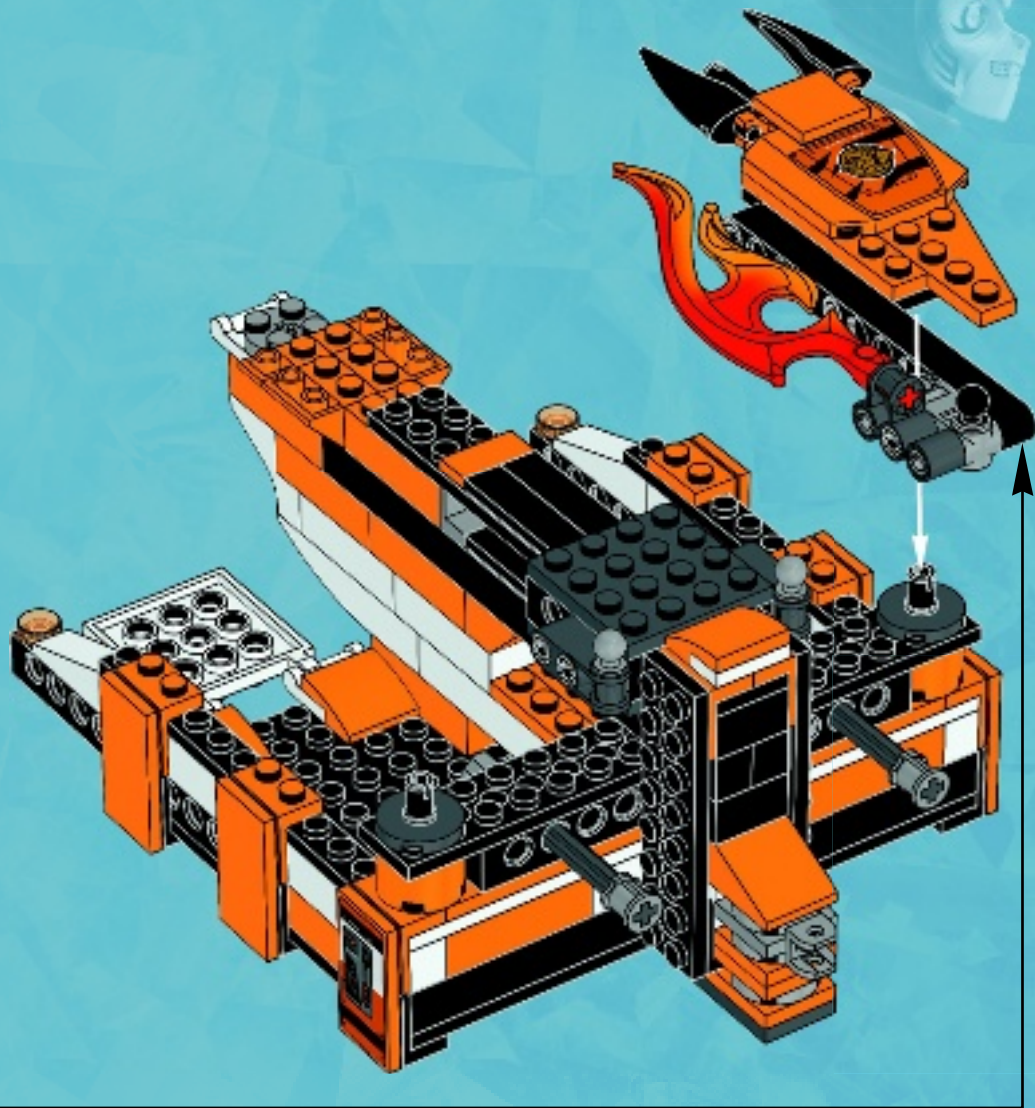

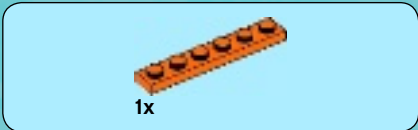

1x

1



2x

2

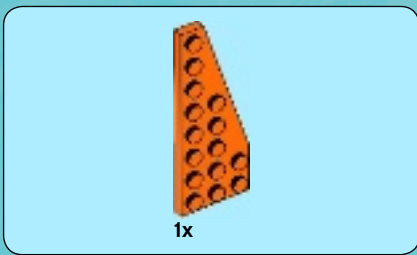
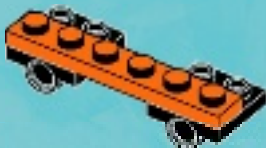

1x

3

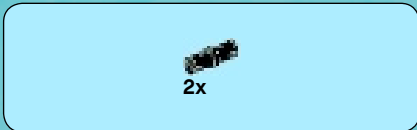

2x

4

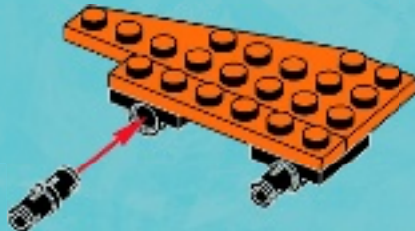





1x

# 5



1x



1x

# 6



1x



2x

# 7

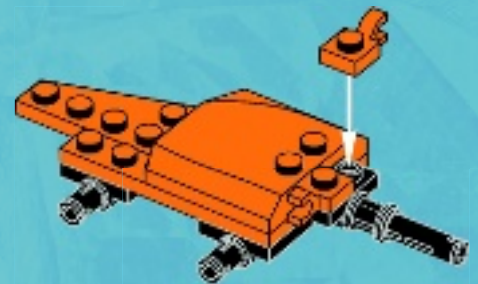



1x

8



1x

9

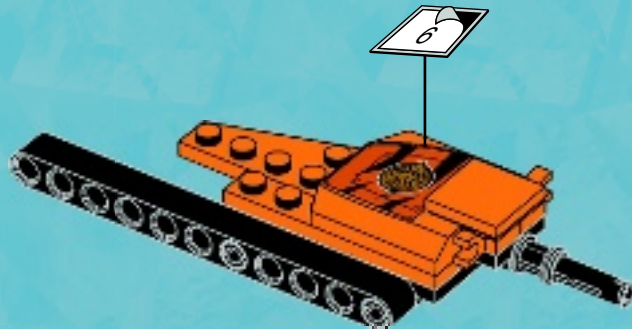



1x



1x

# 10



1x



1x

# 11

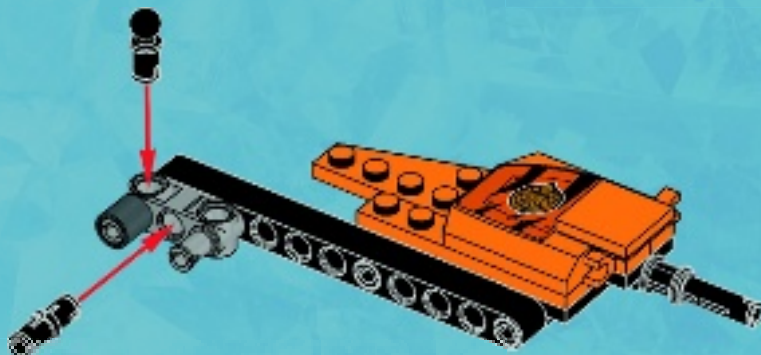





1x

# 12

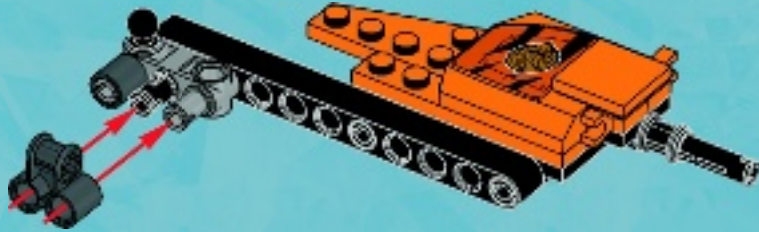

1x



2x

# 13



36

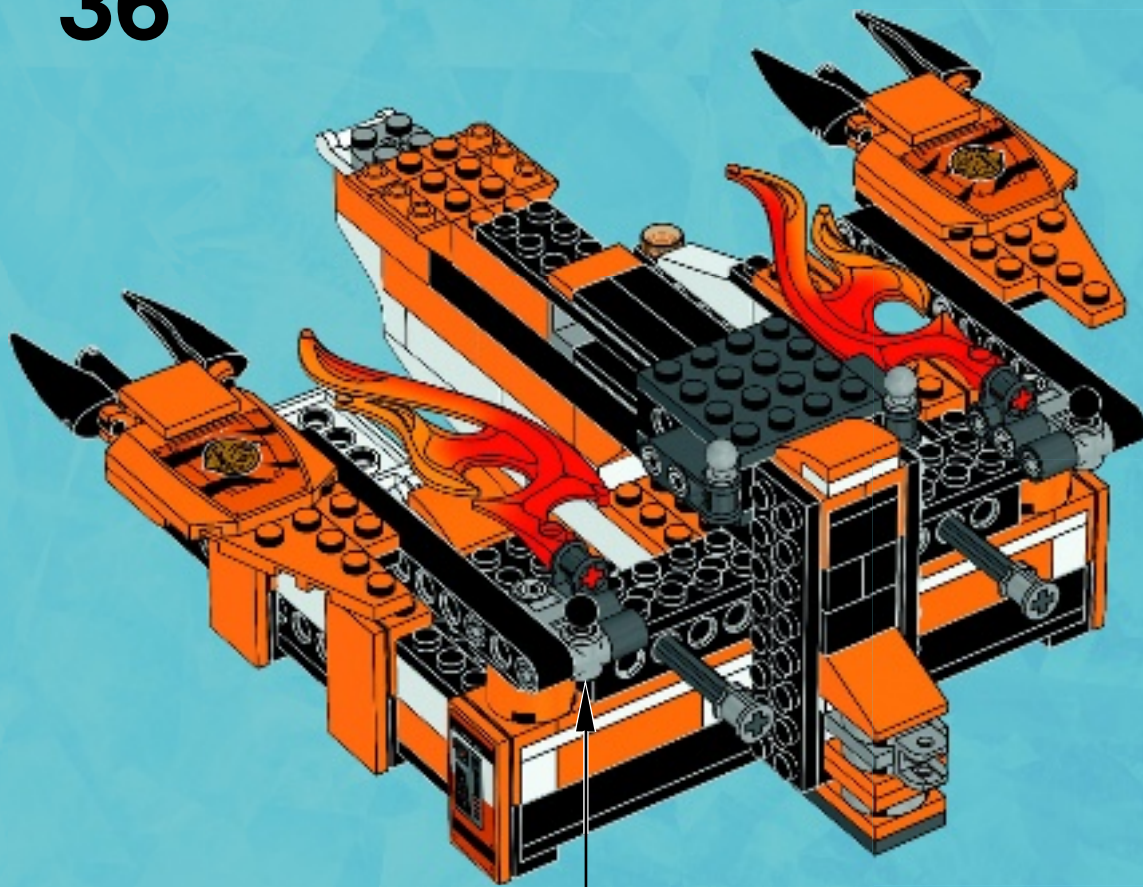





2x

37

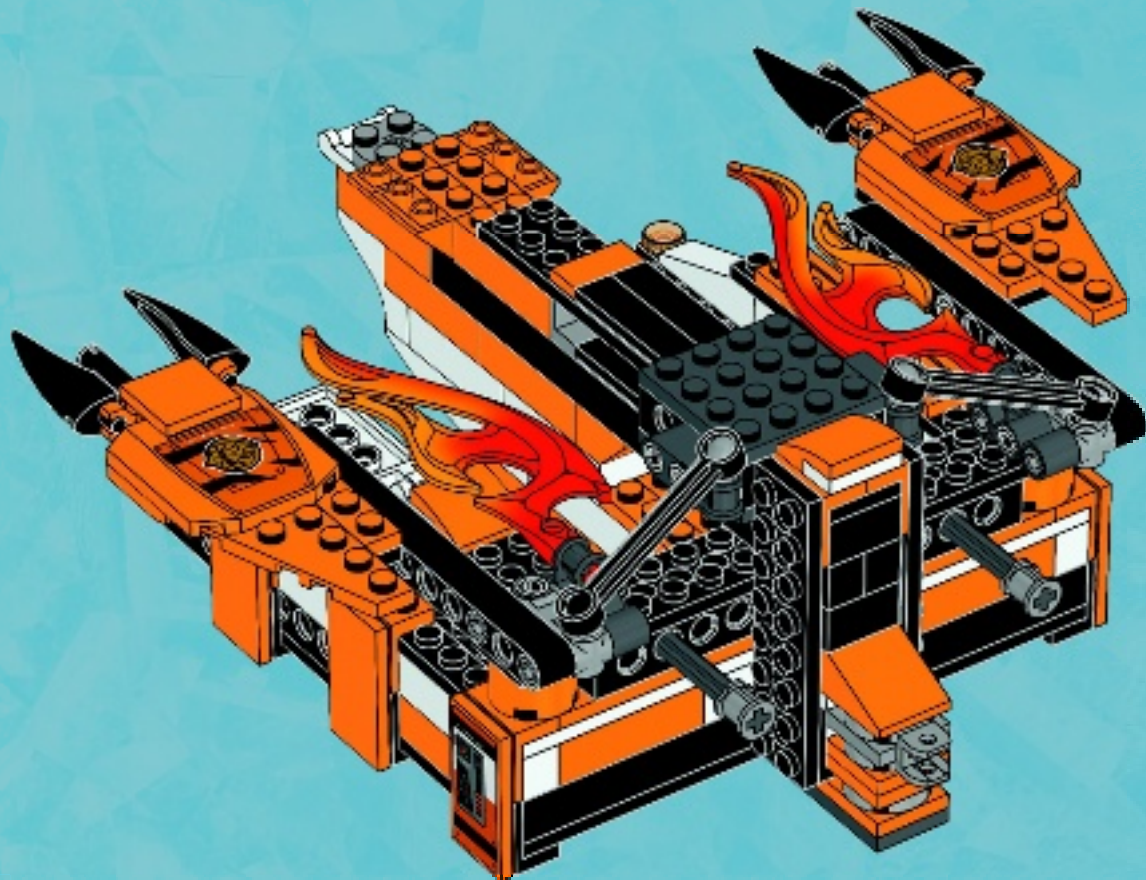





2x

# 38

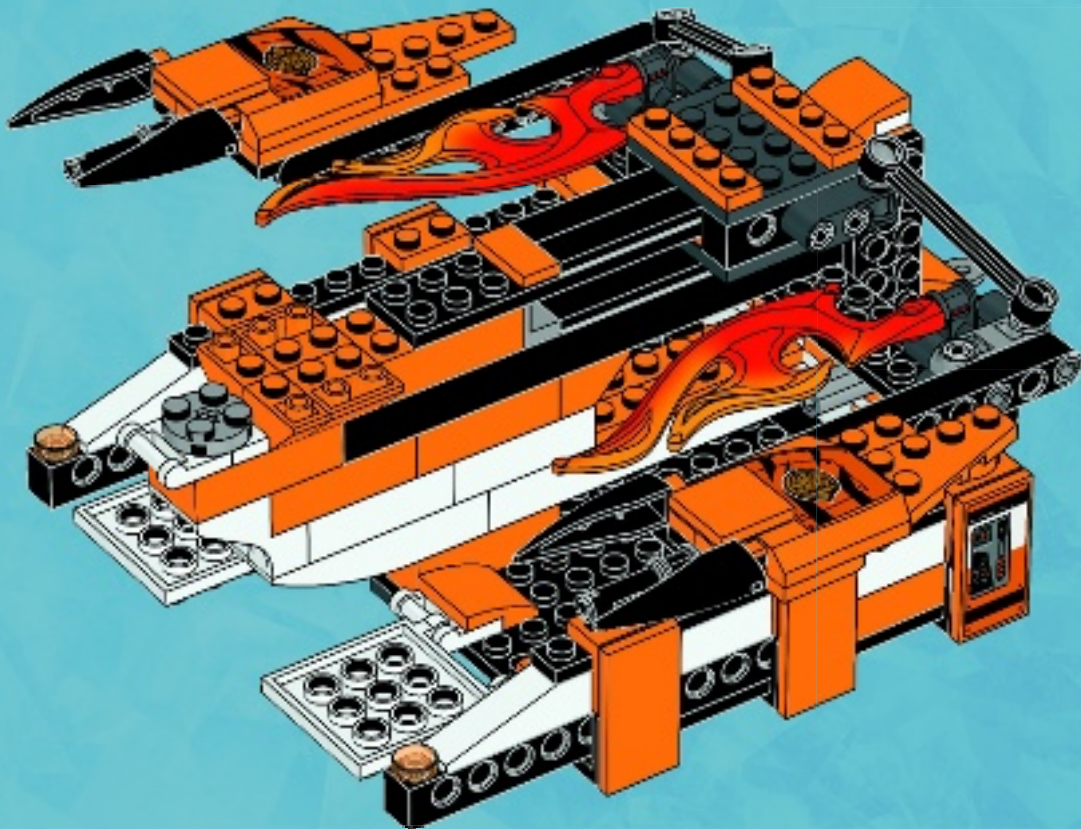
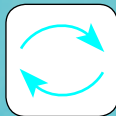



1x



2x

# 39

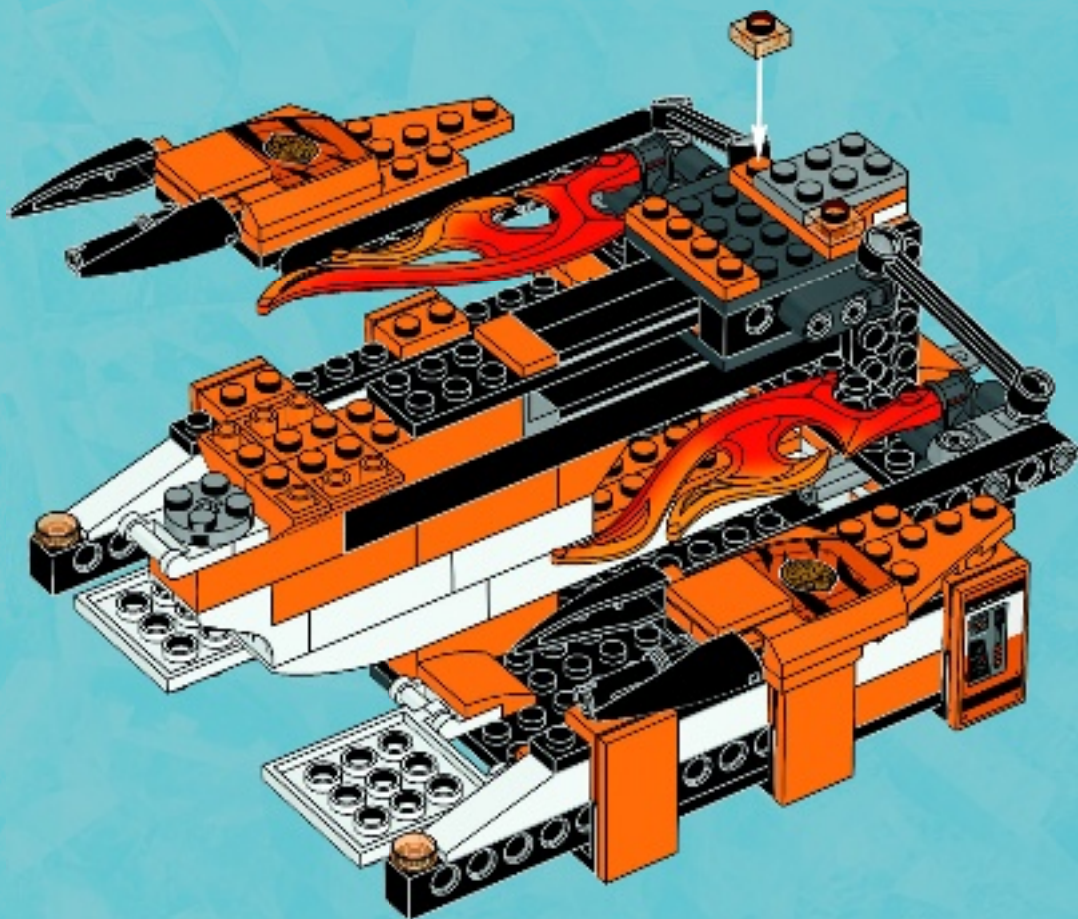





2x



1x



2x

# 40

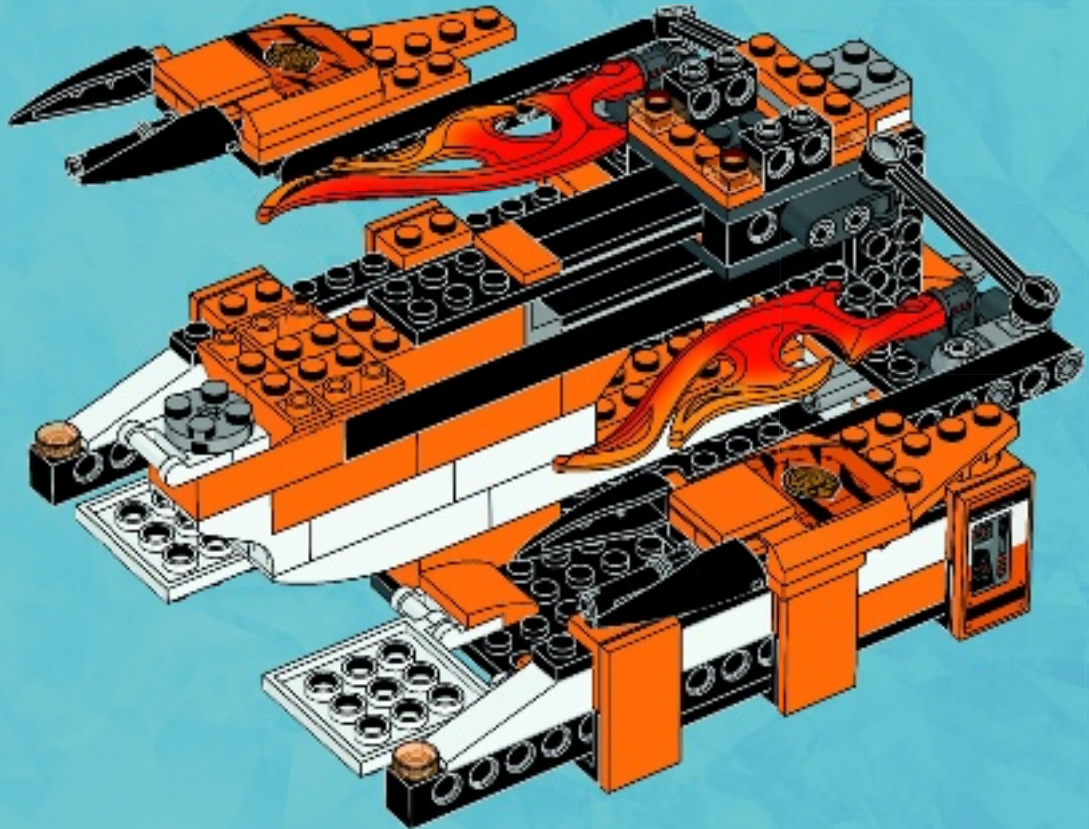





2x



2x

# 41

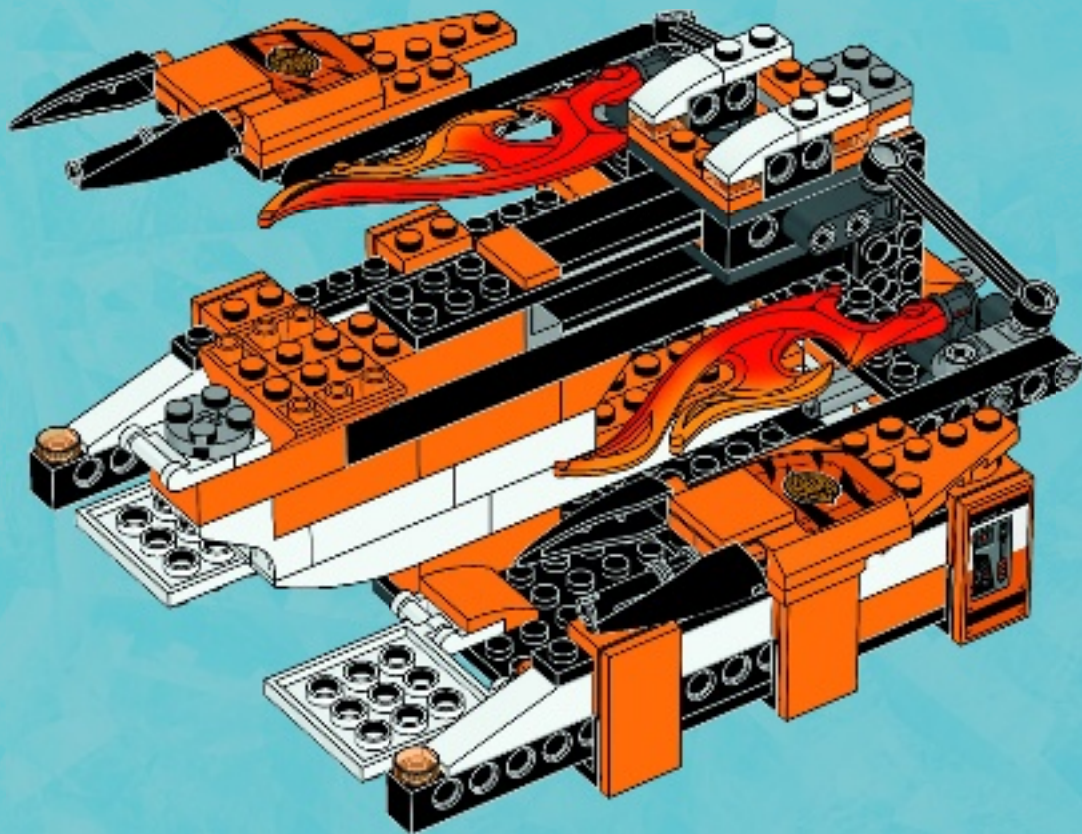



2x

# 42

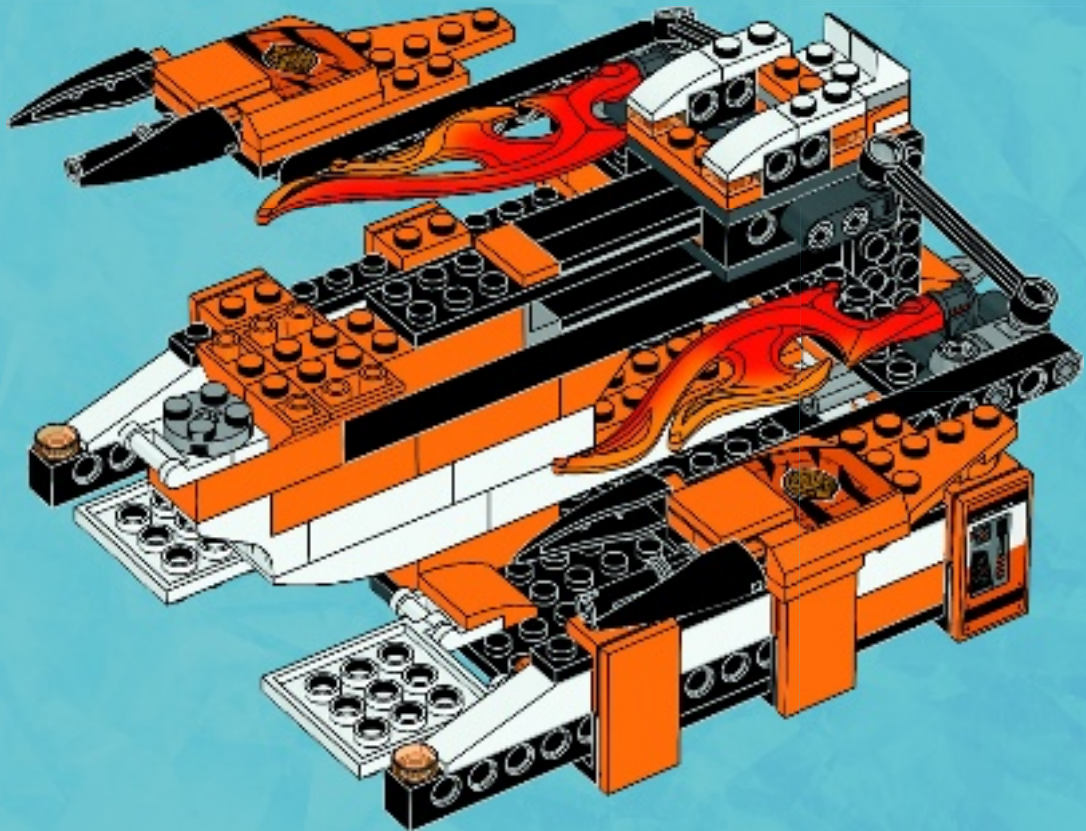





1x



1x

# 43

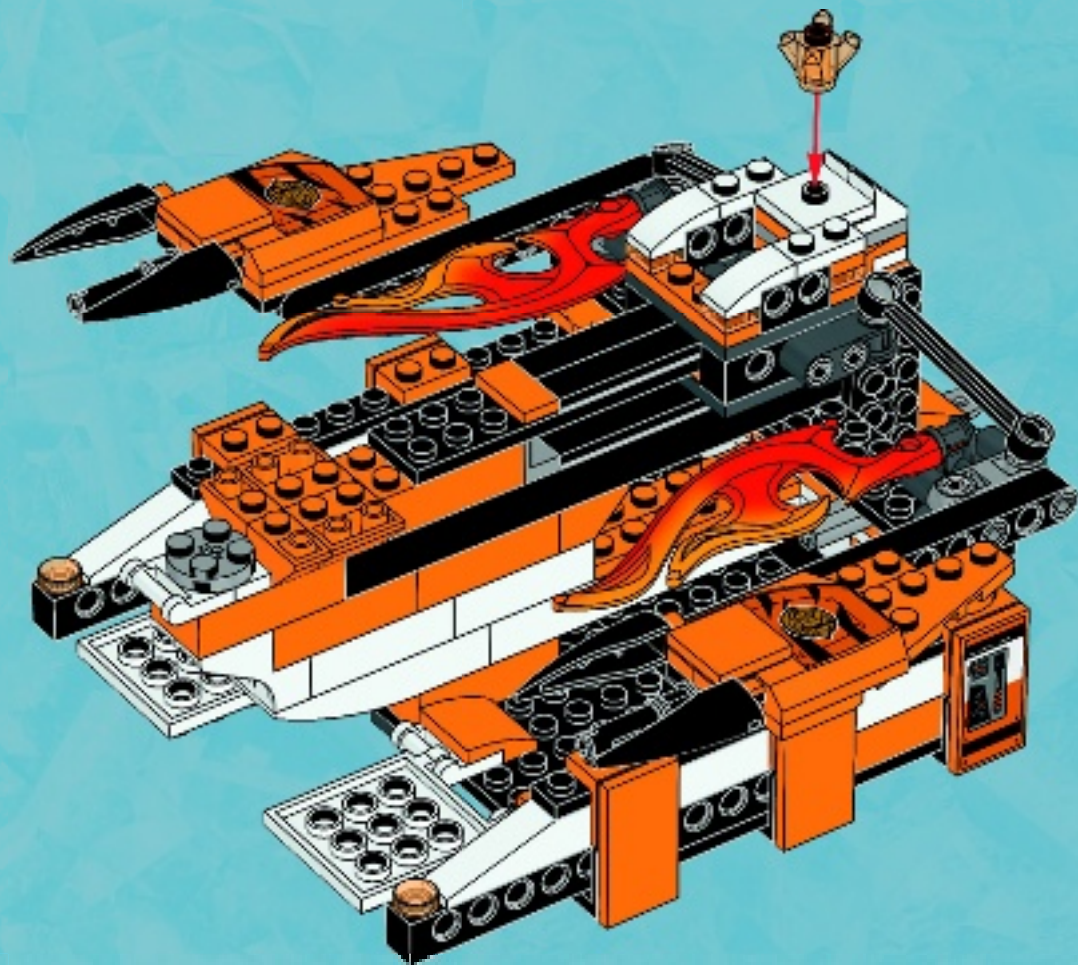



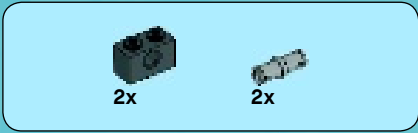

44

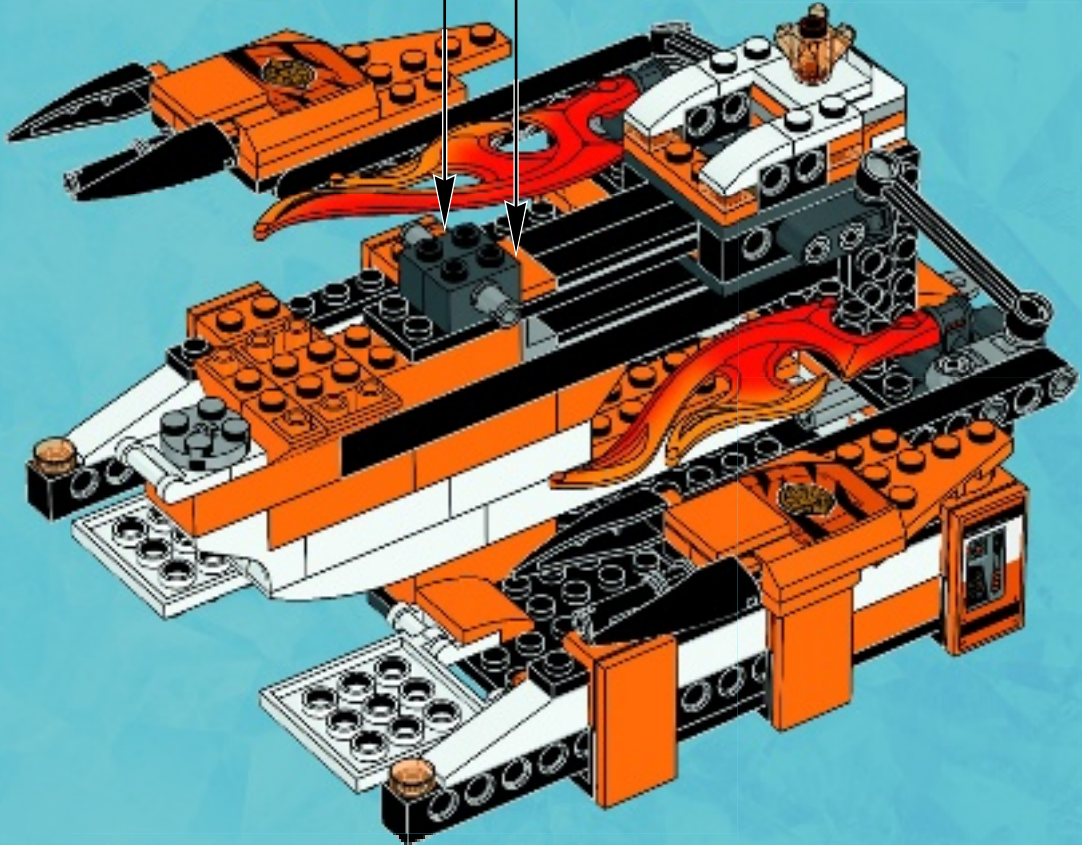
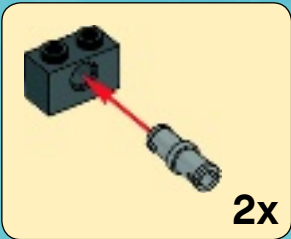

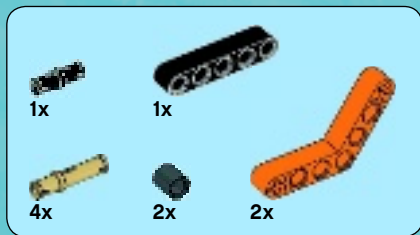

# 45

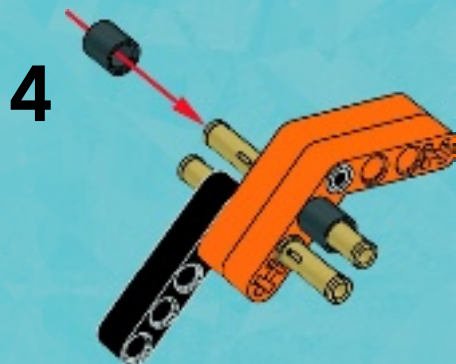

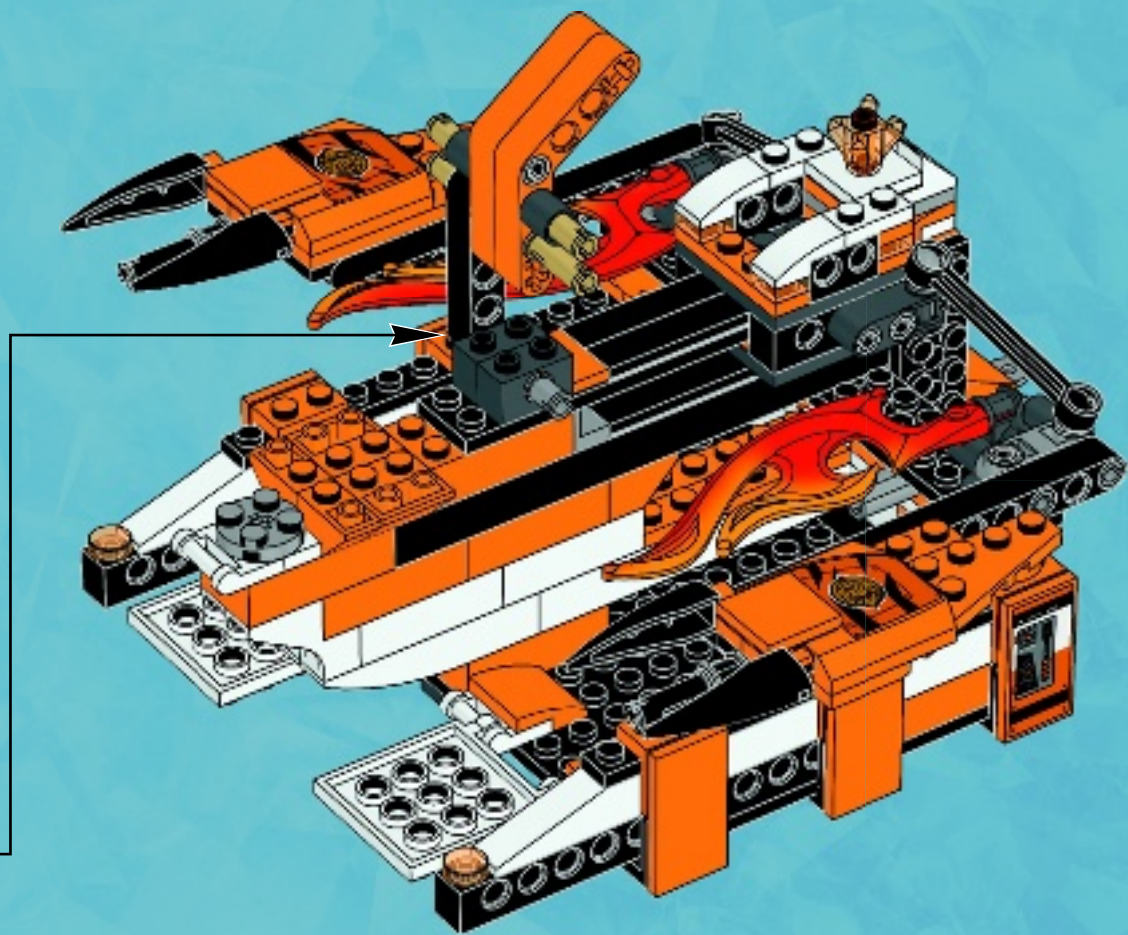





1x

# 46

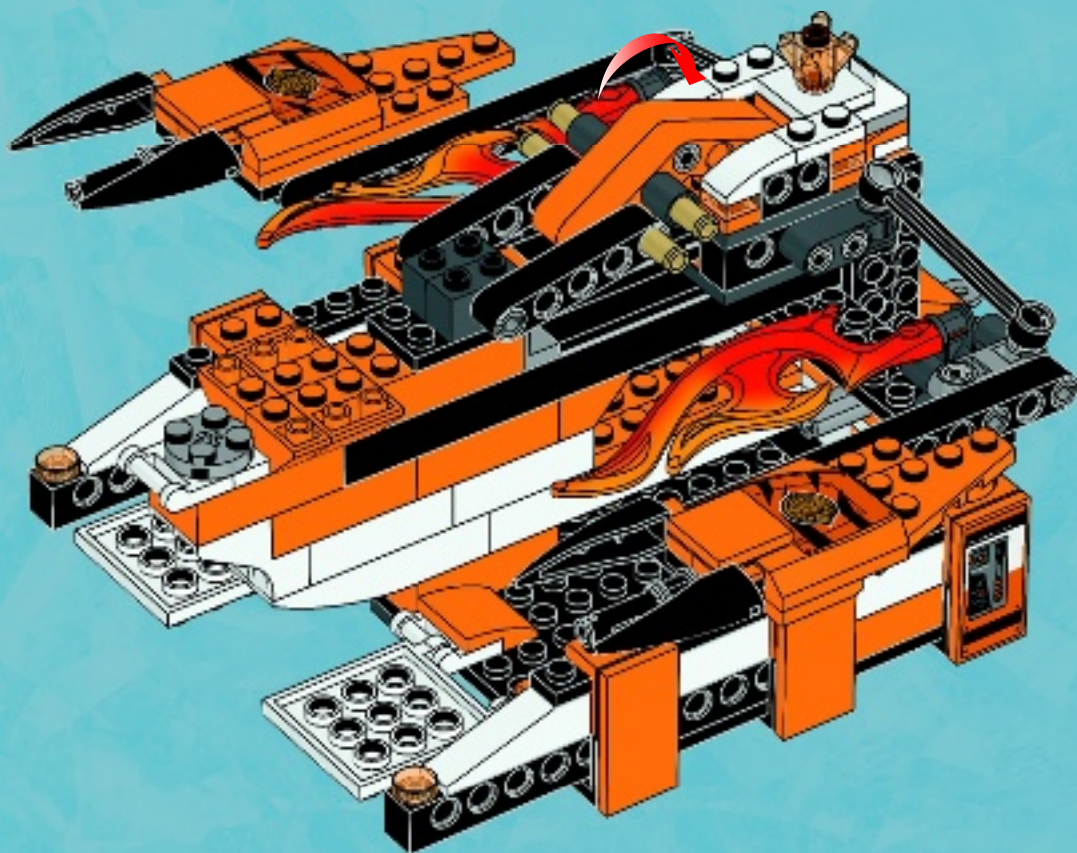

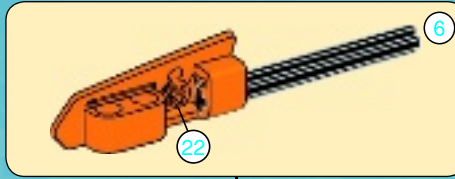
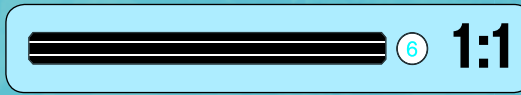
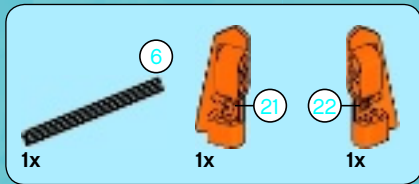

47

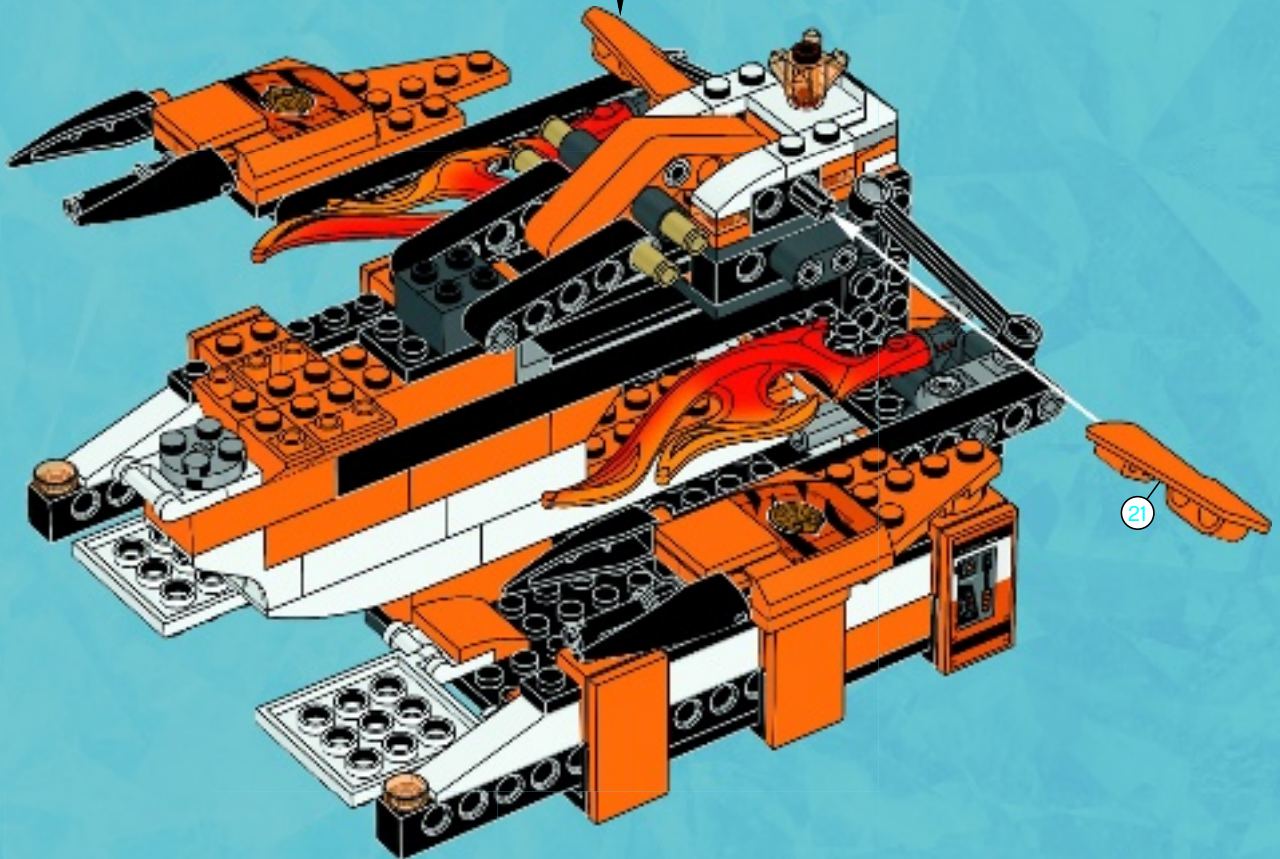



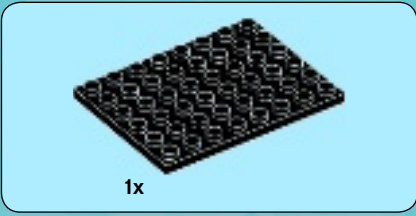

1x

1

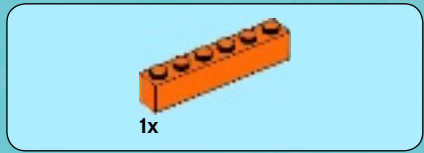

1x

2



1x

1x

1x

3





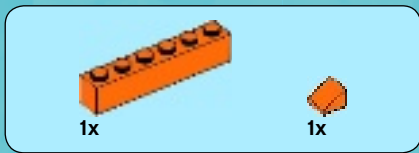

4

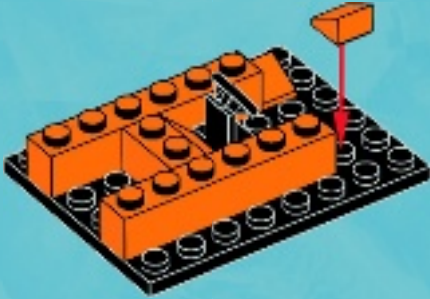

5

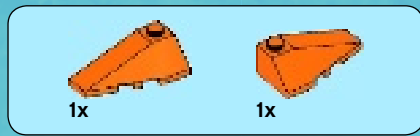
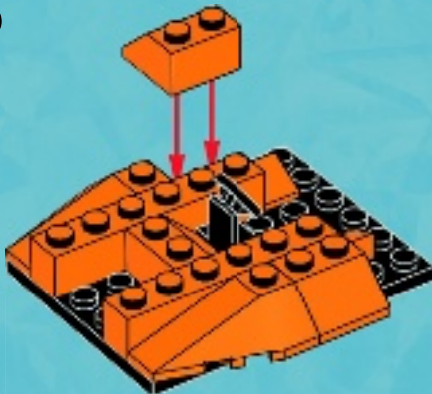

6



7

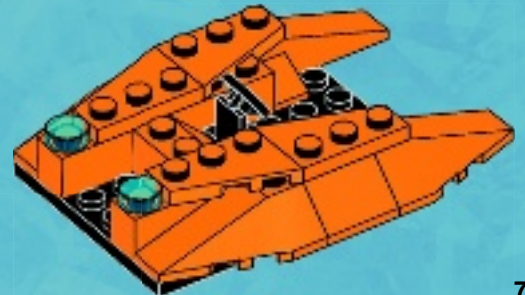

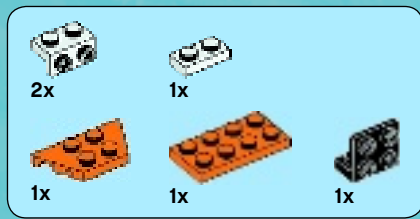

8

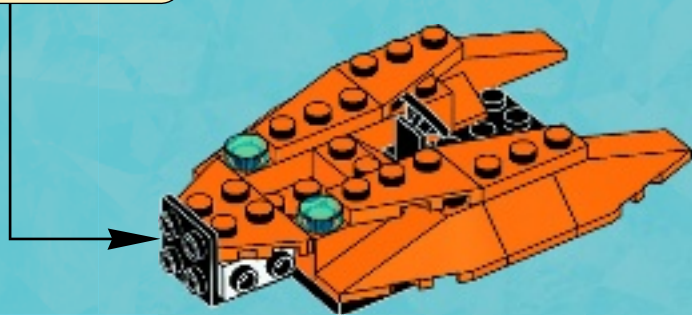
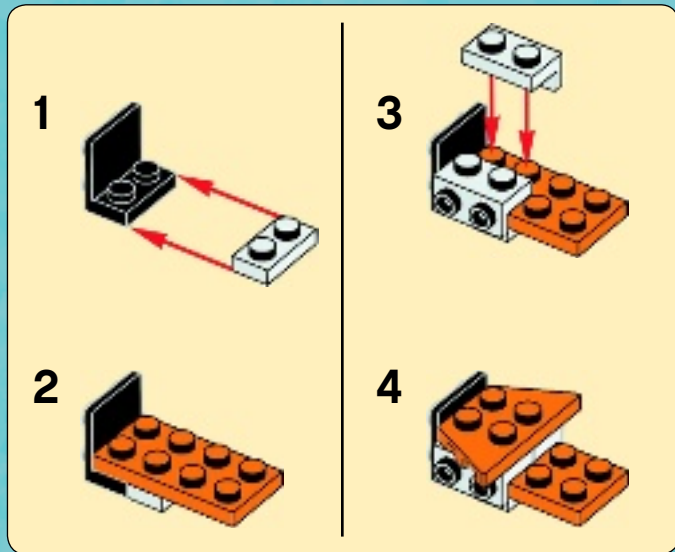



1x

9



1x



2x

10







1x

11



1x

12





1x

# 13



2x



2x

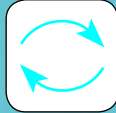

# 14



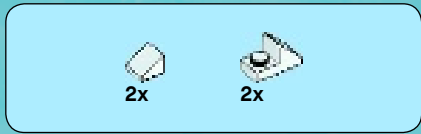

15

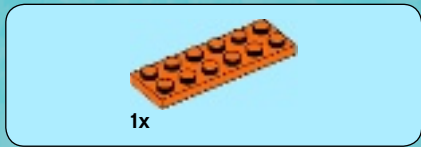
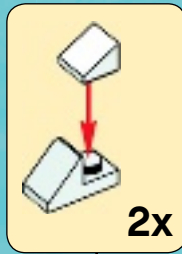

16







2x

17



18

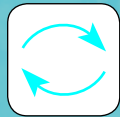

48







1x

# 49







1x

# 50

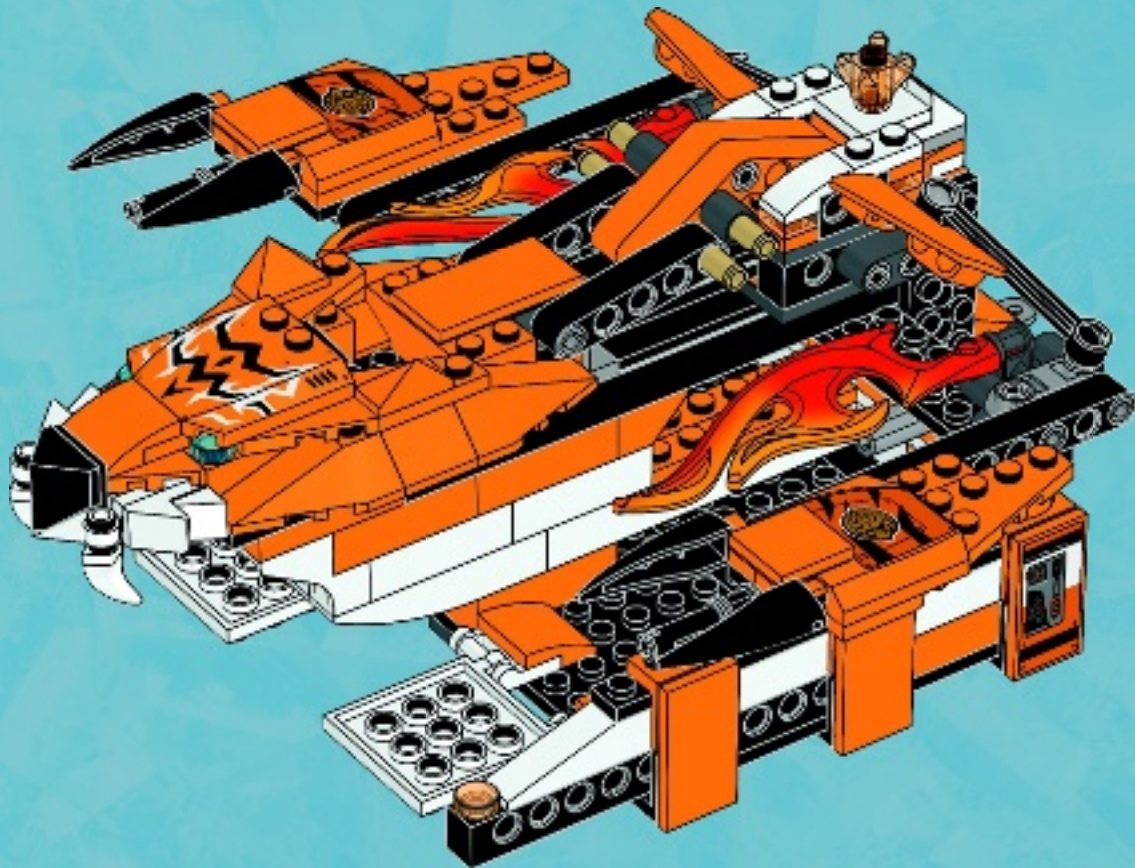



2x



1x



1x



4x



3x



1x



2x

# 51

1



2



3



4

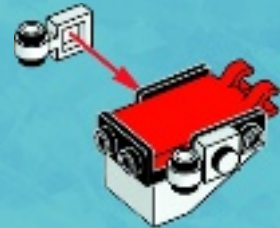

5

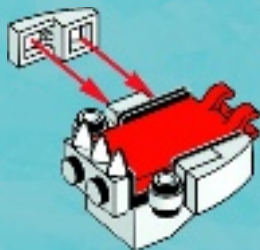

6

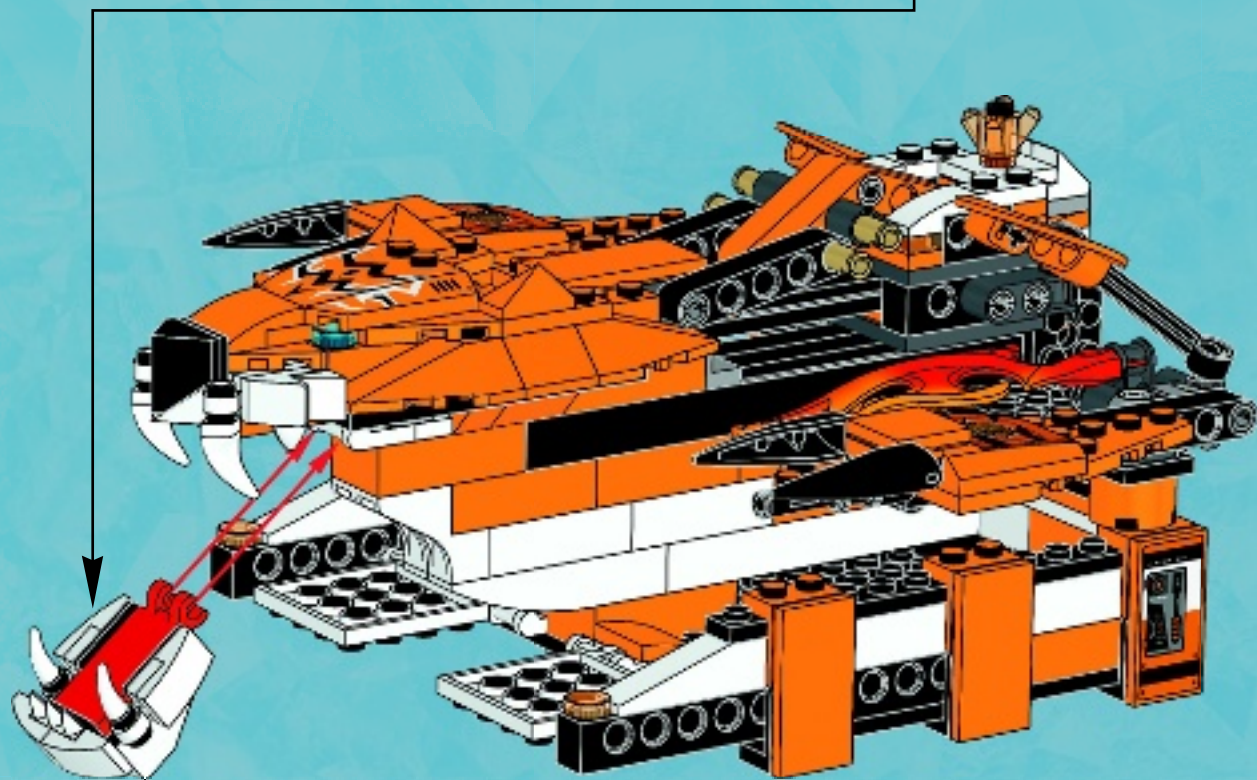





1x

1



2x

2



1x



1x

3



1x

4

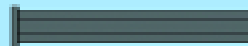
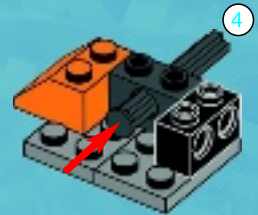

4

1:1



5

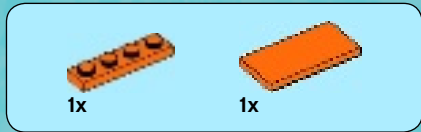

6



7



52

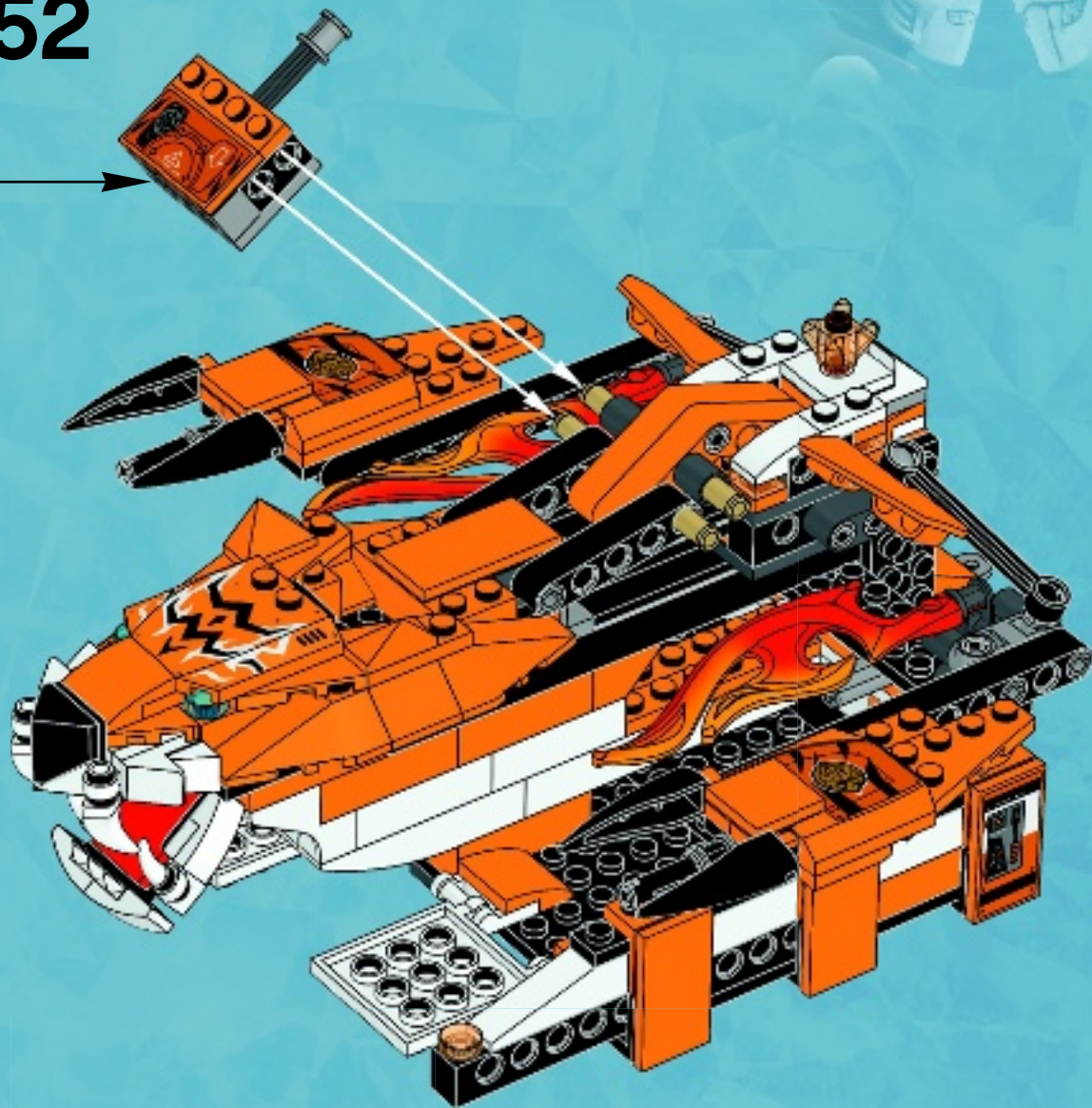





1x

1



2x

2



1x



1x

3



1x

4

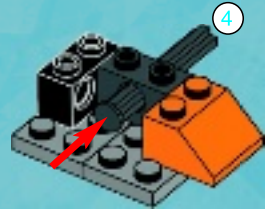

4

1:1



5



6



7



53

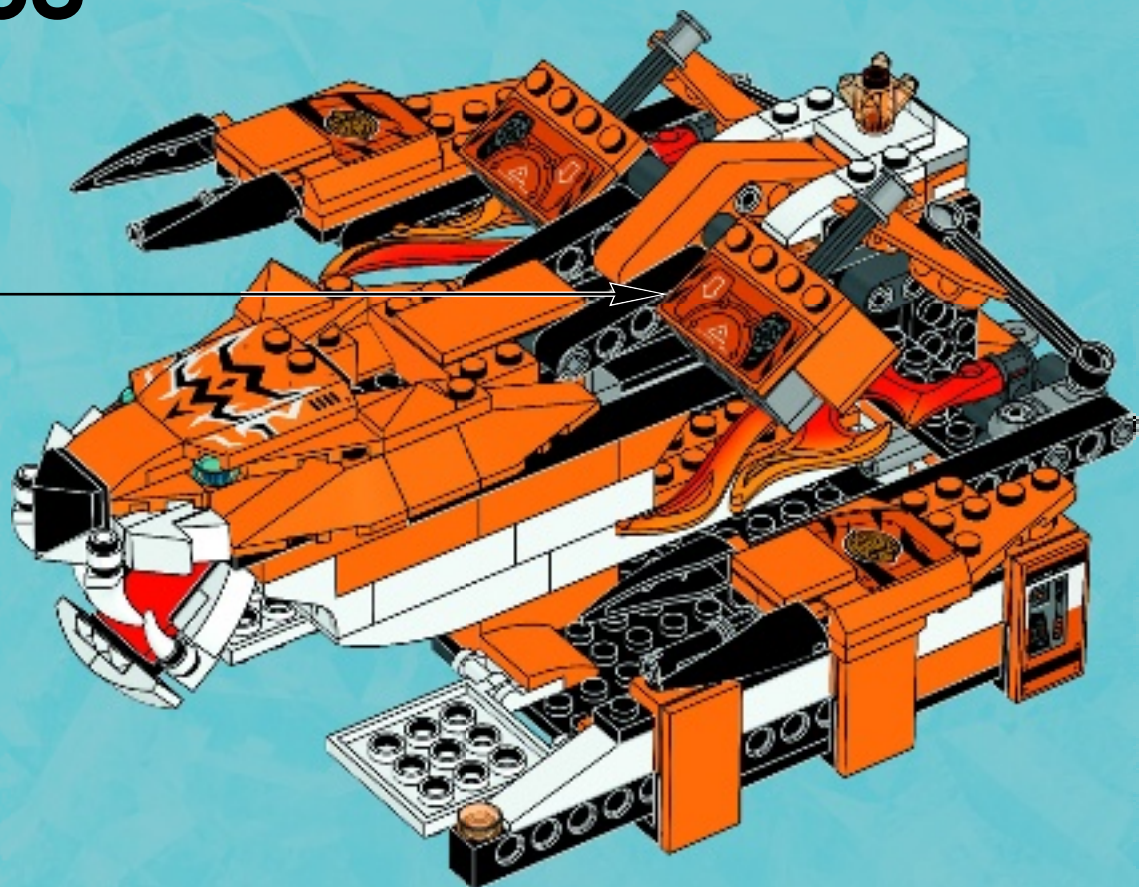



54

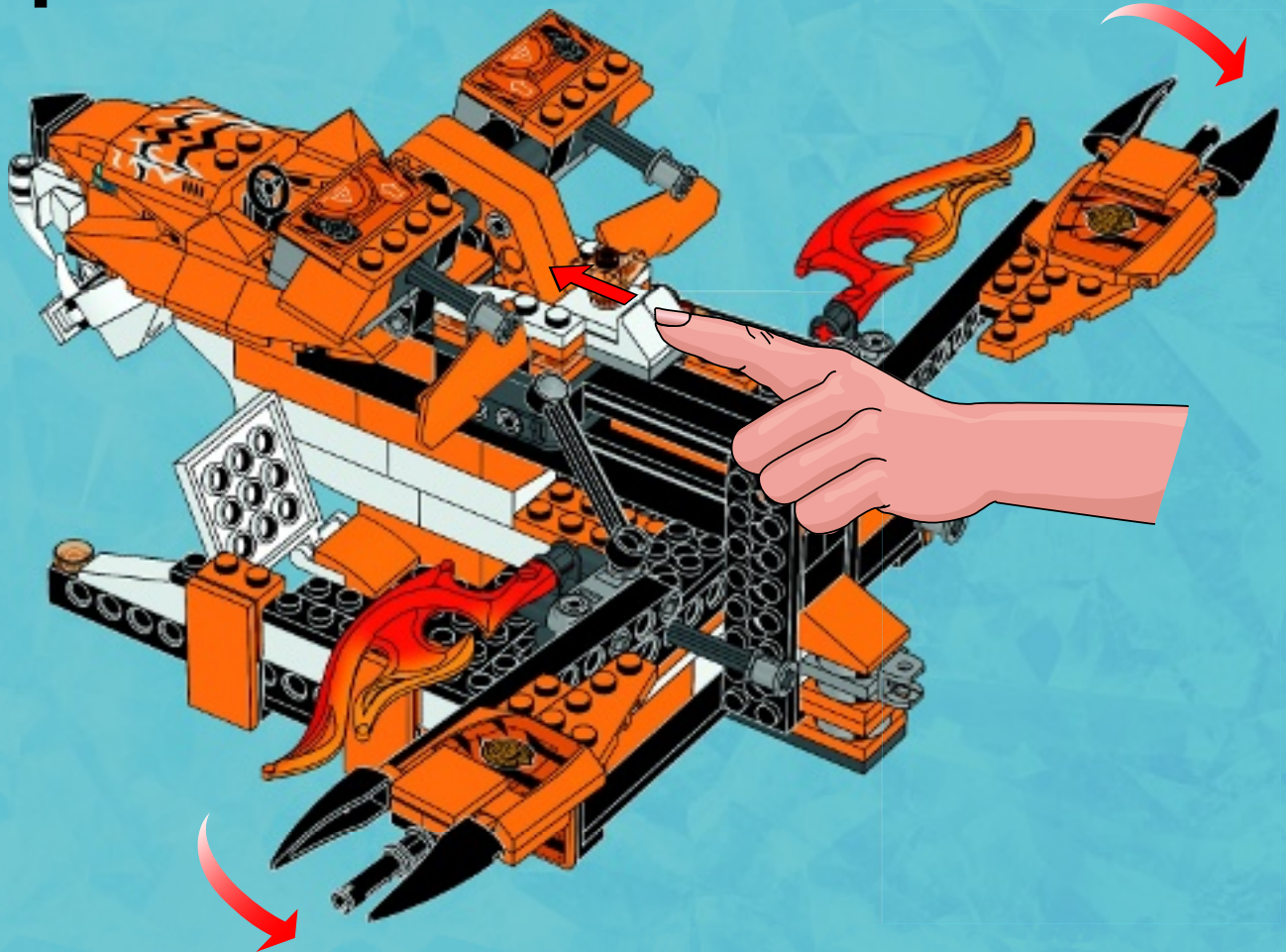
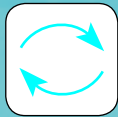



3x



# 55

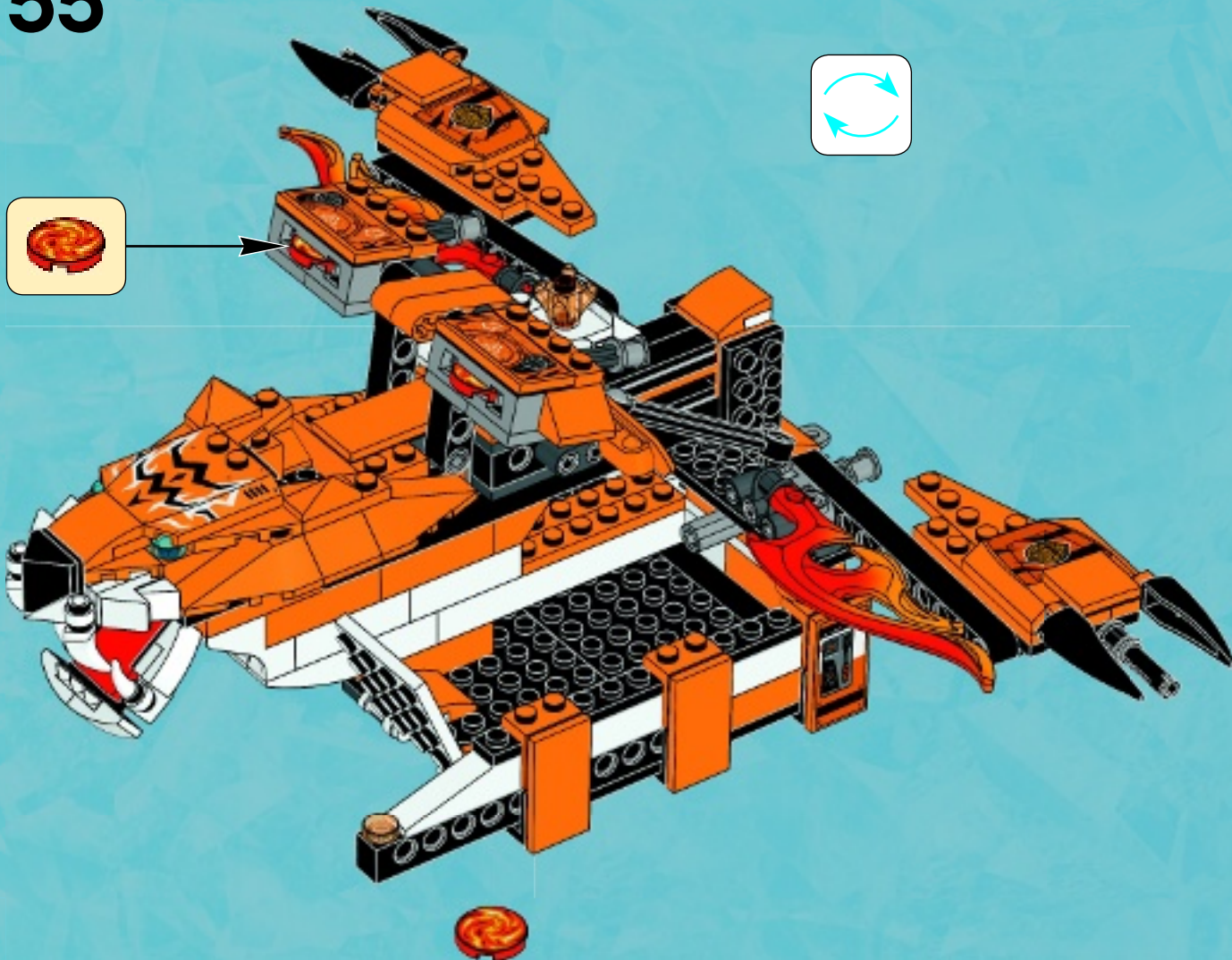
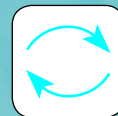



56

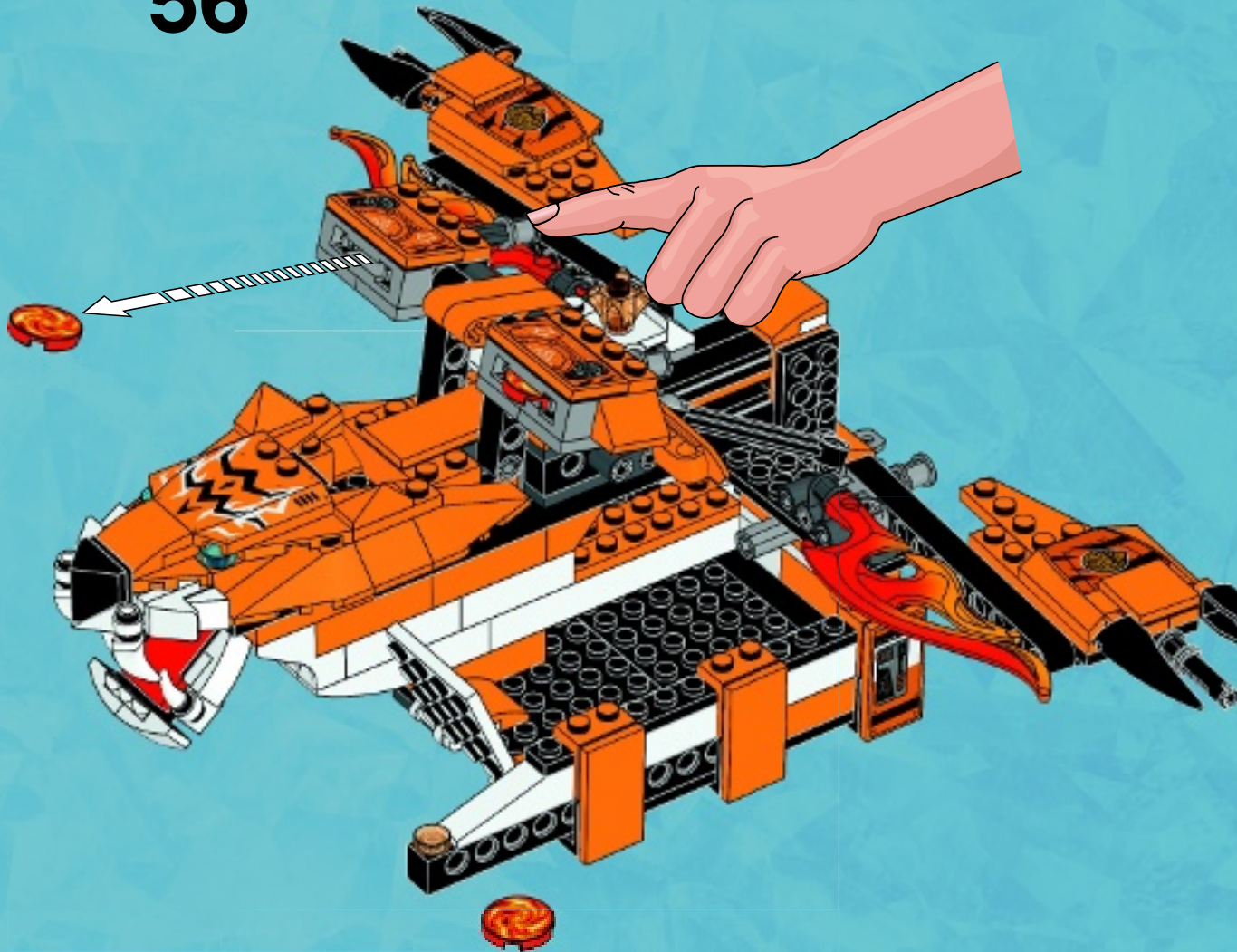





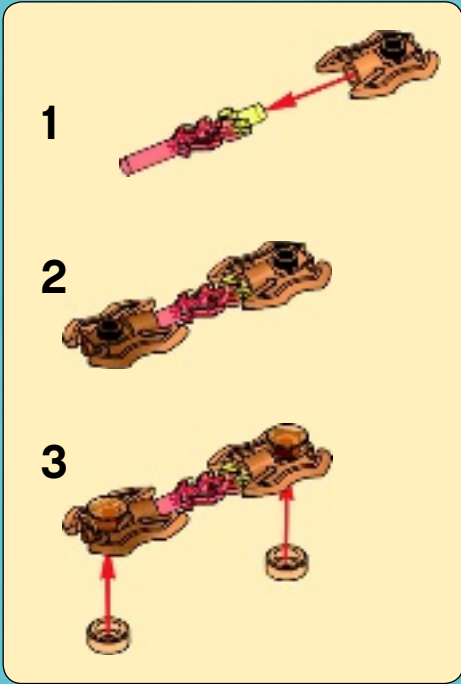
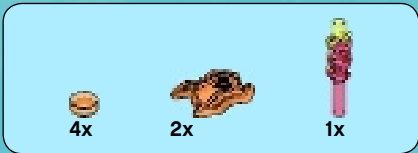

3



4



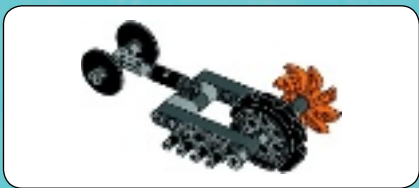

1

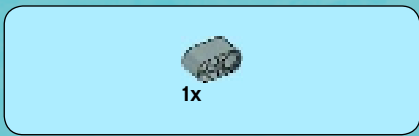

2

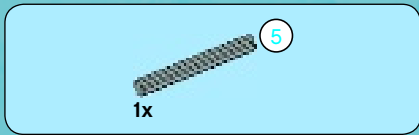

3

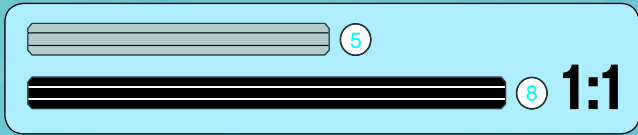
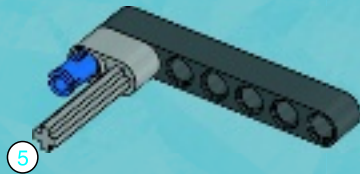



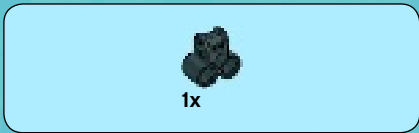

4



5

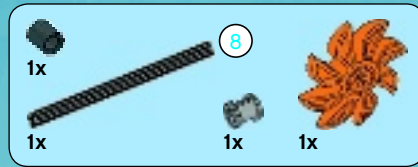
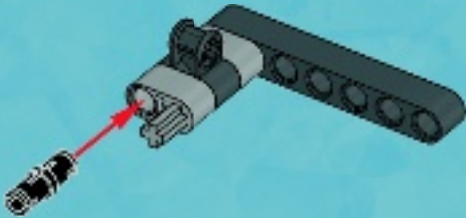

6

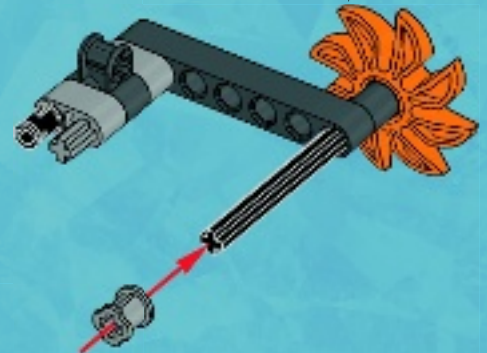
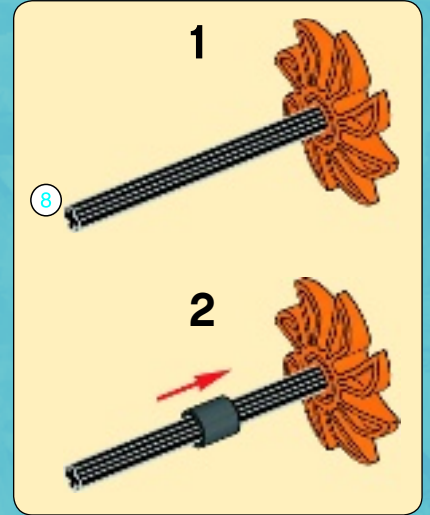

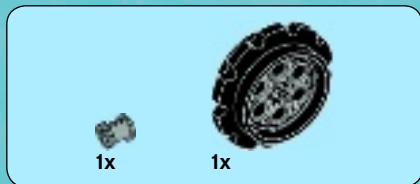

7

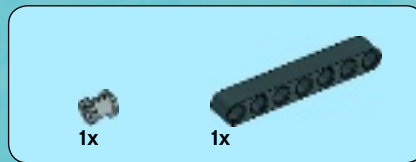
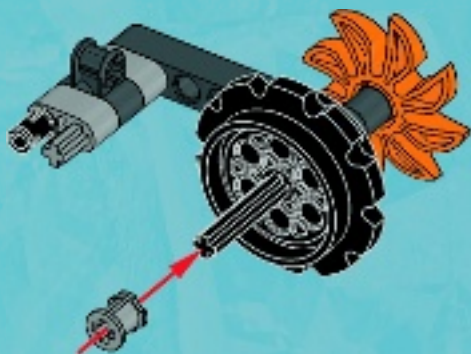

8

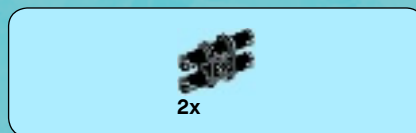
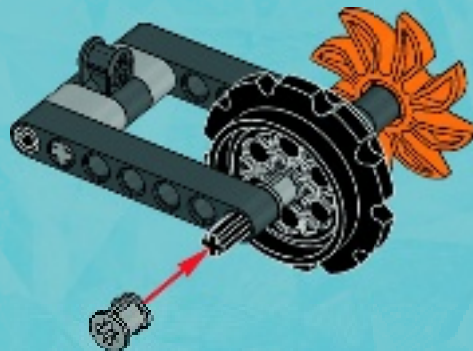

9

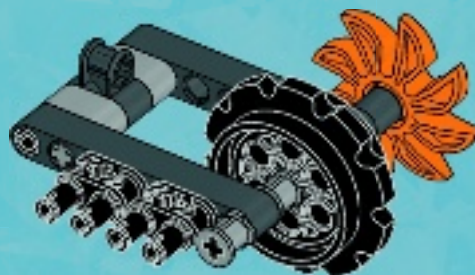

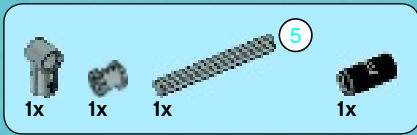

# 10

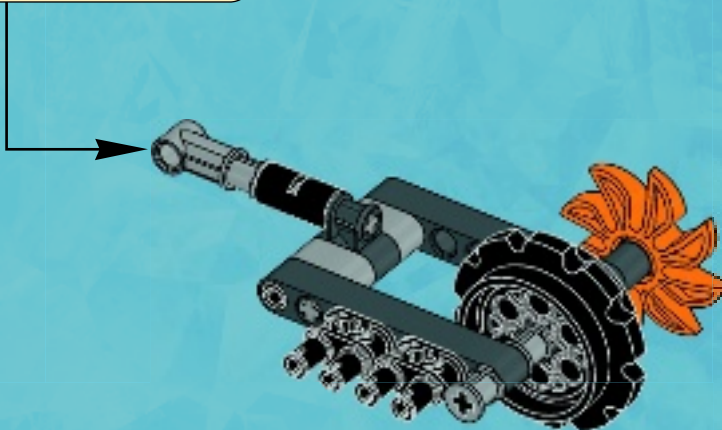
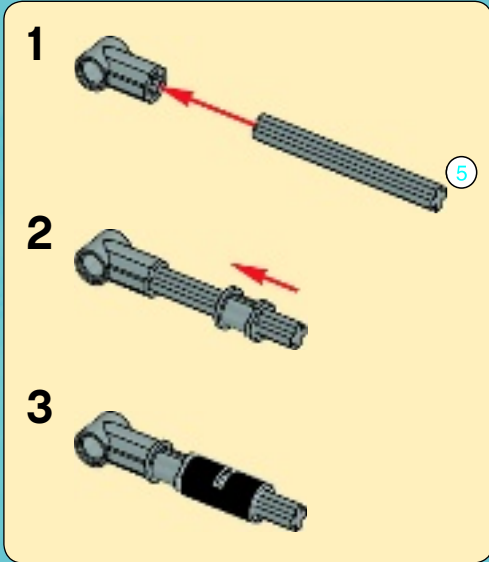



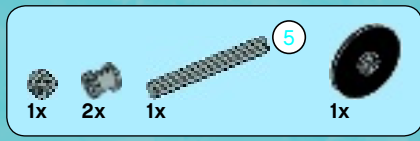

# 11

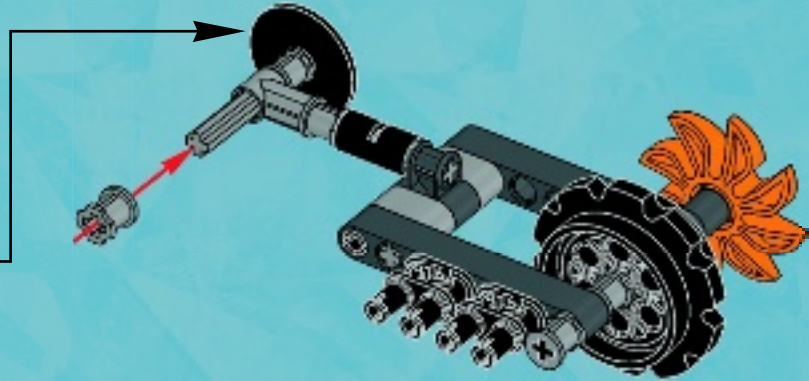
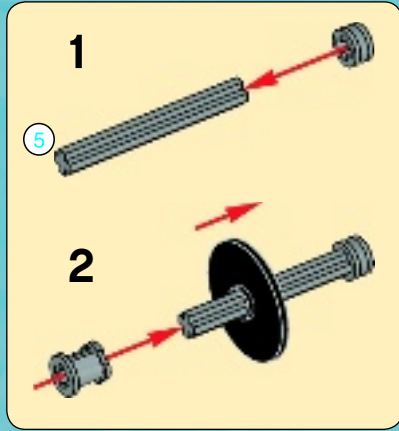

# 12

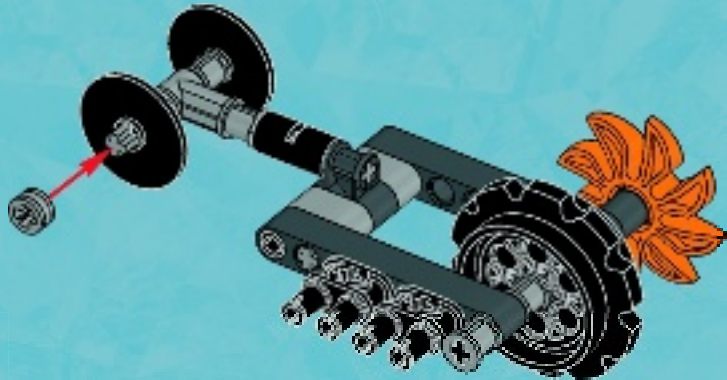

57

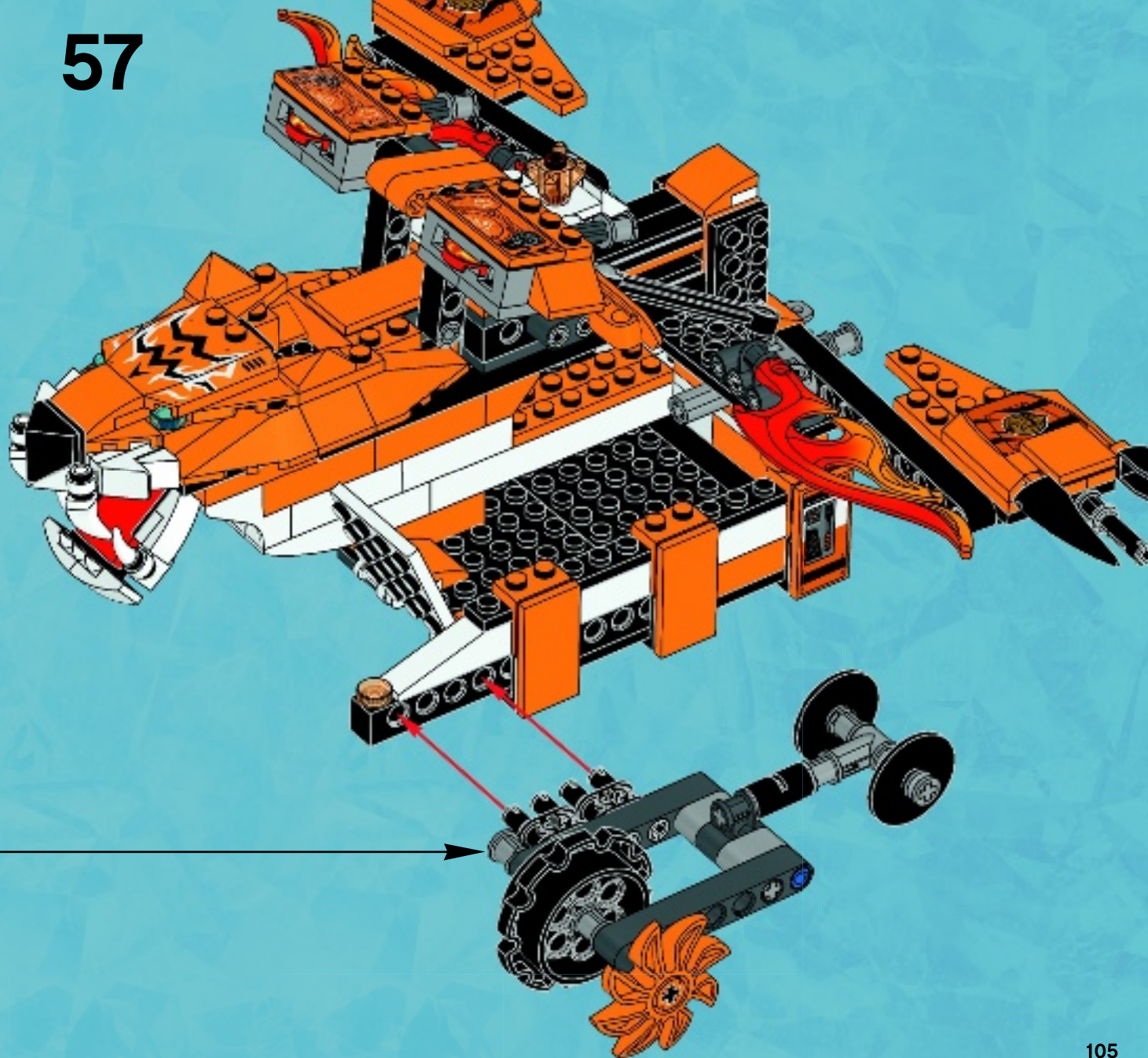





11x



11x

# 58





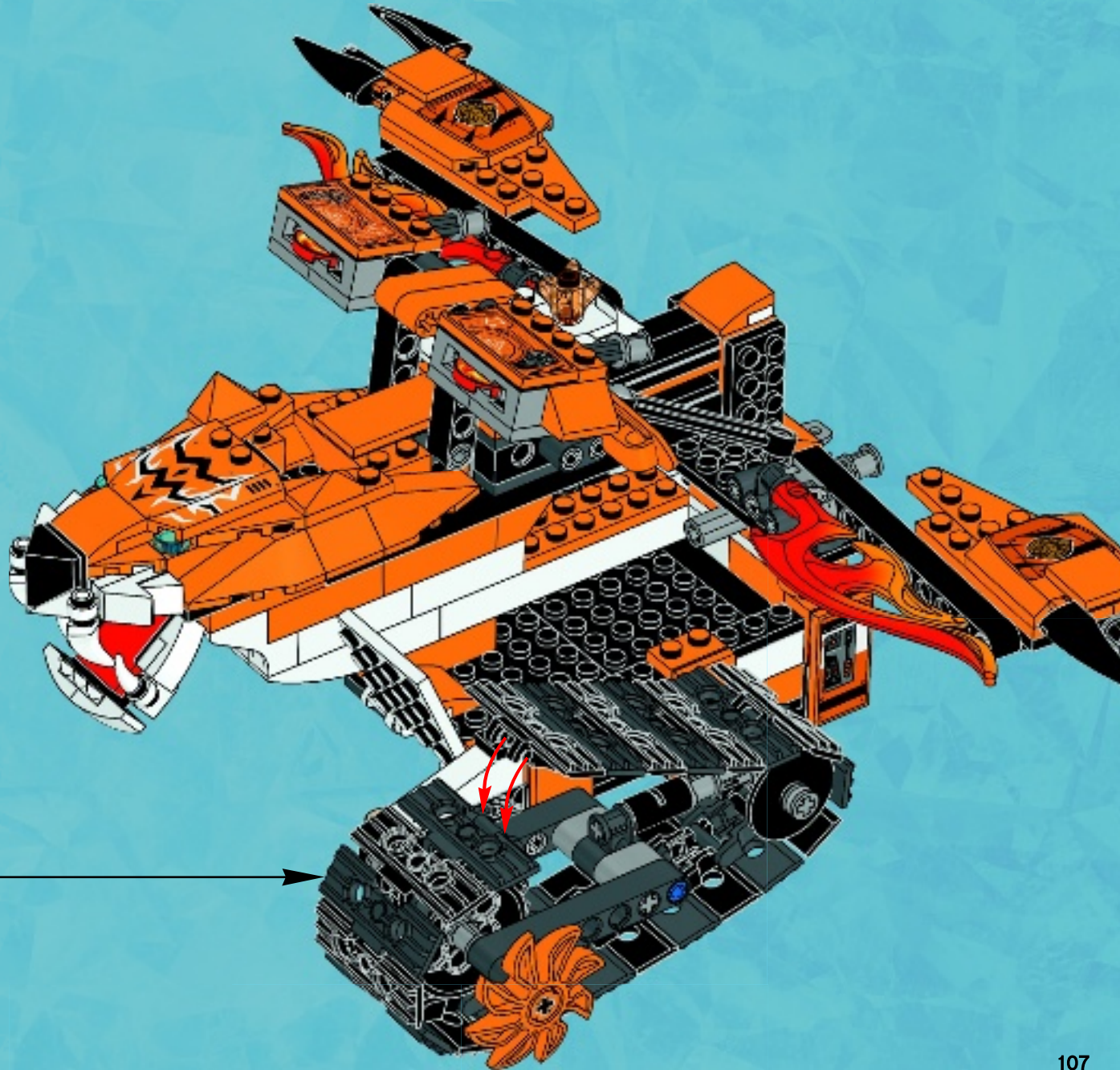

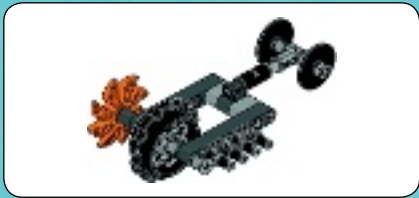

1

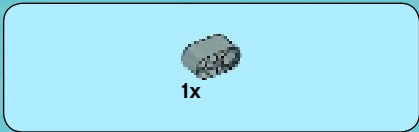

2

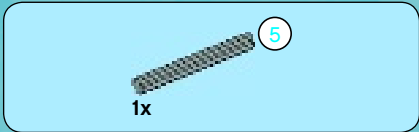

3

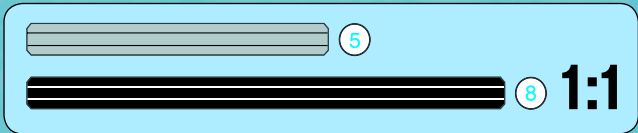
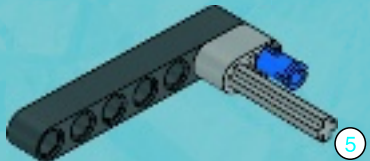

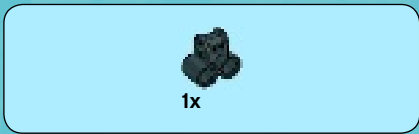

4

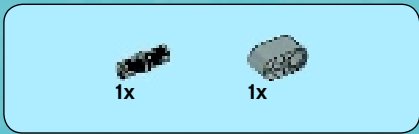

5

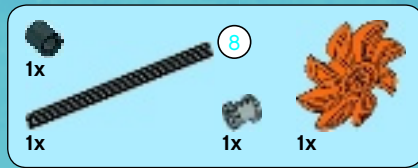
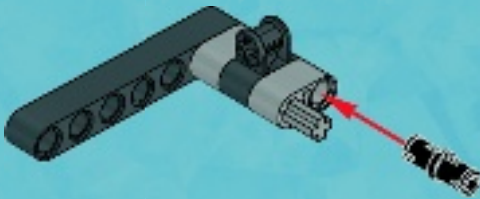

6

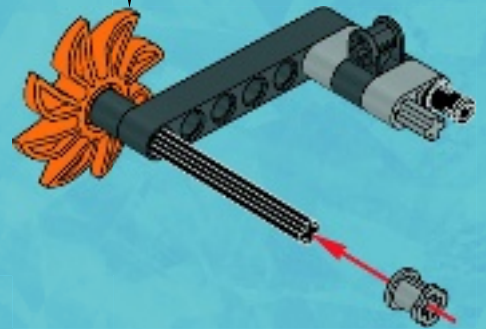
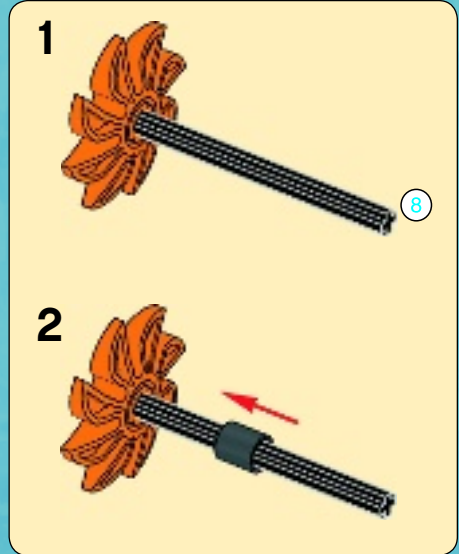



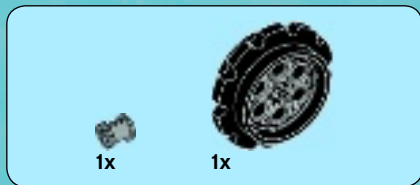

7

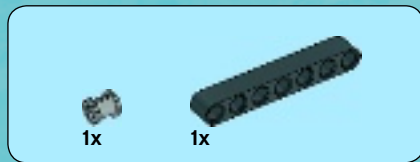
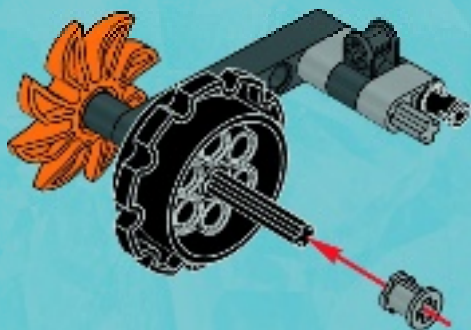

8

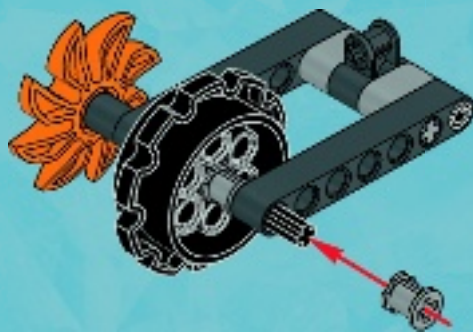

9

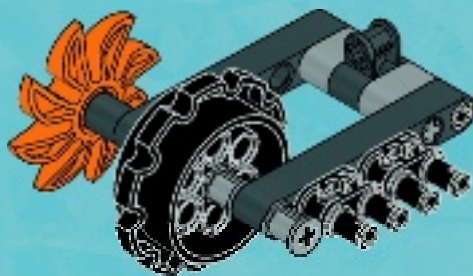

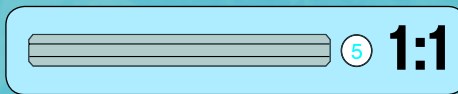
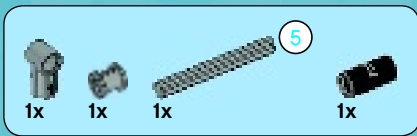

# 10

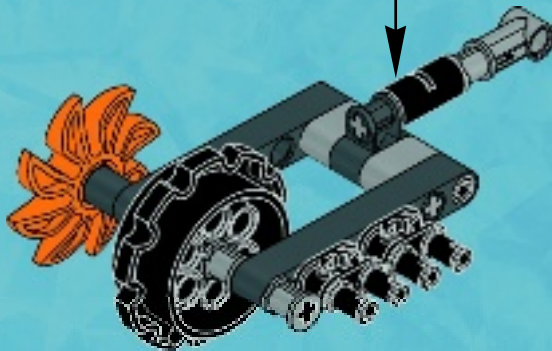
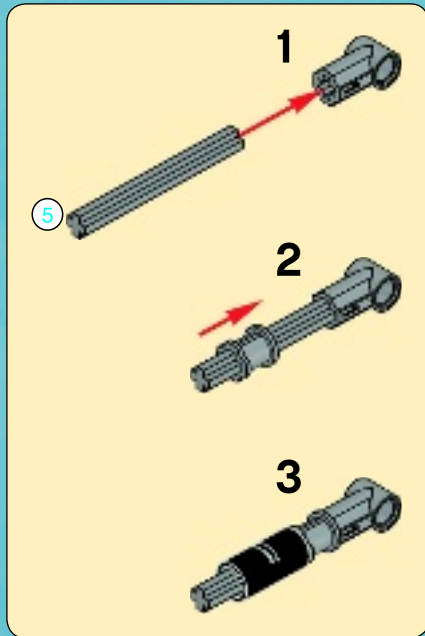

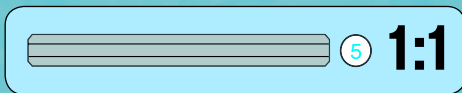
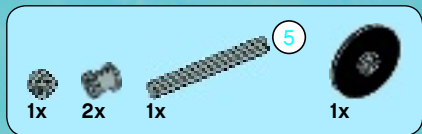

# 11

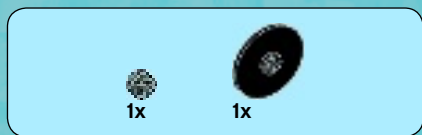
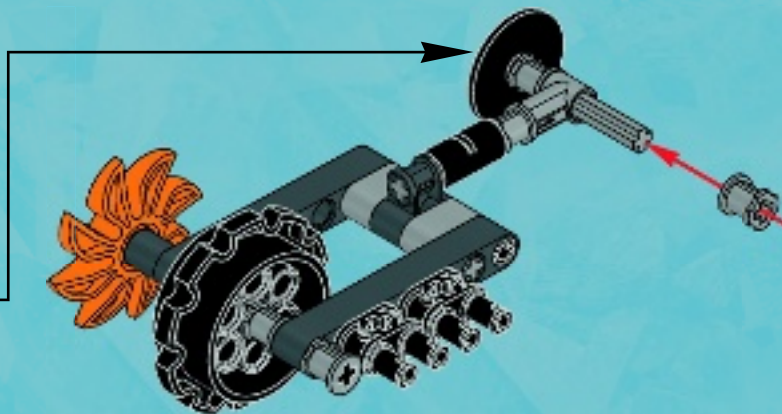
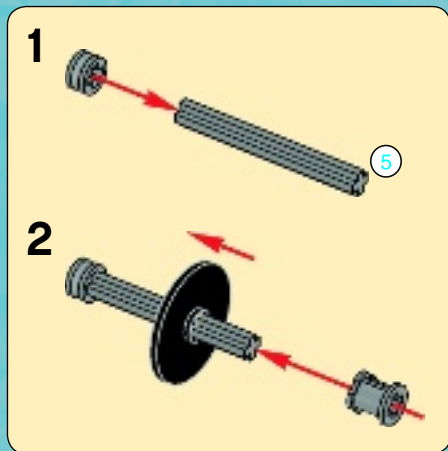

# 12

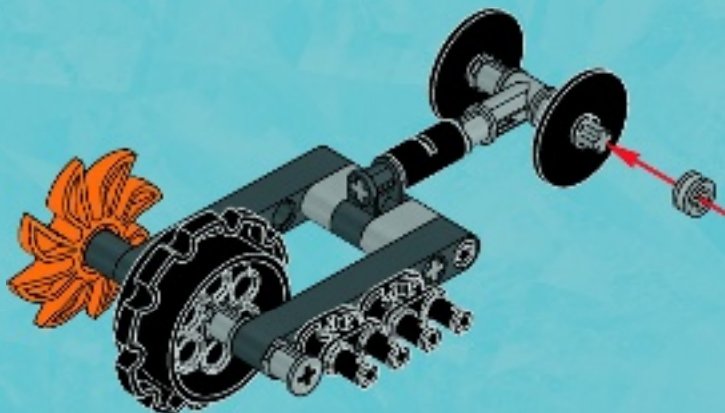



59

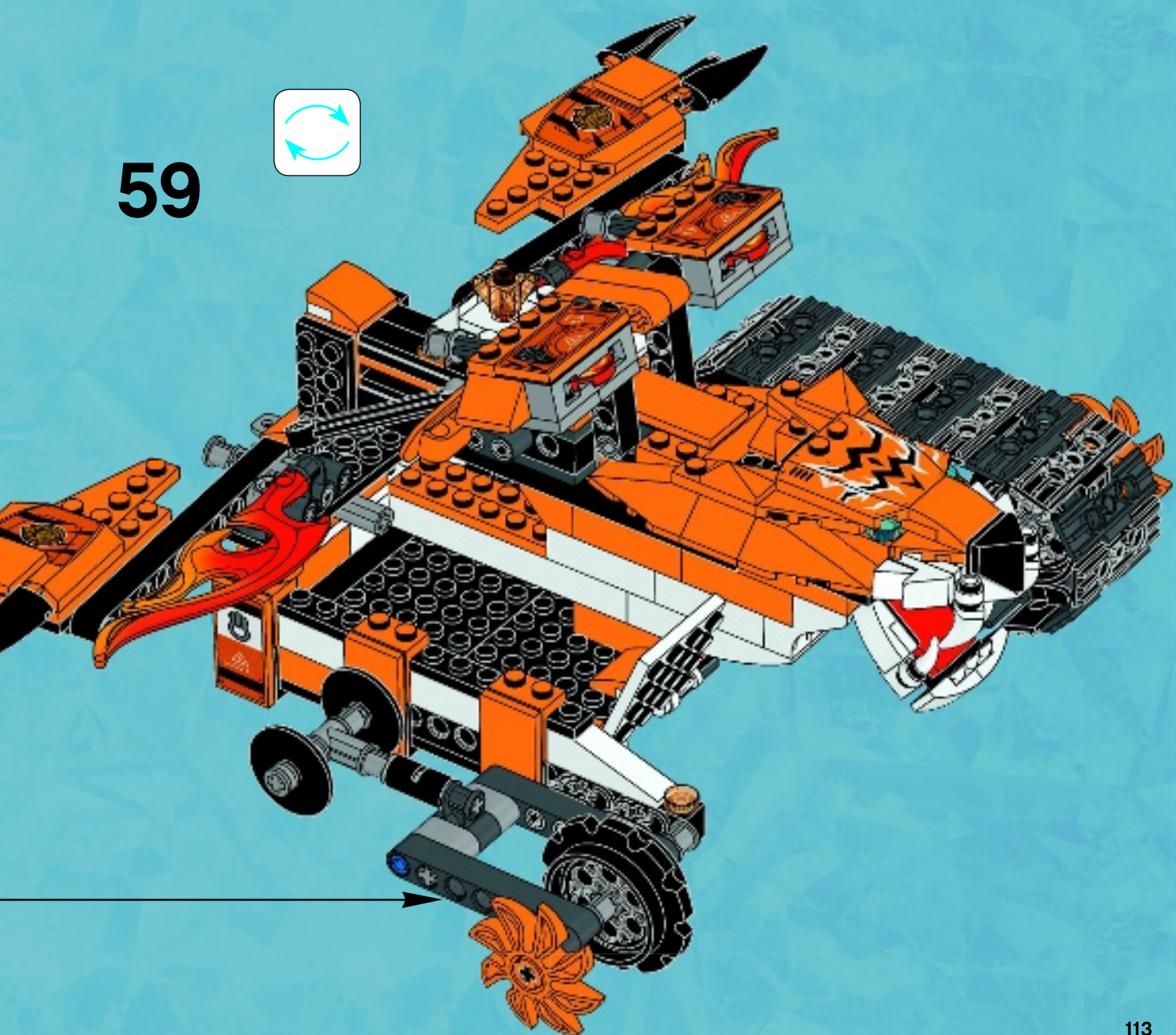



11x



11x

# 60





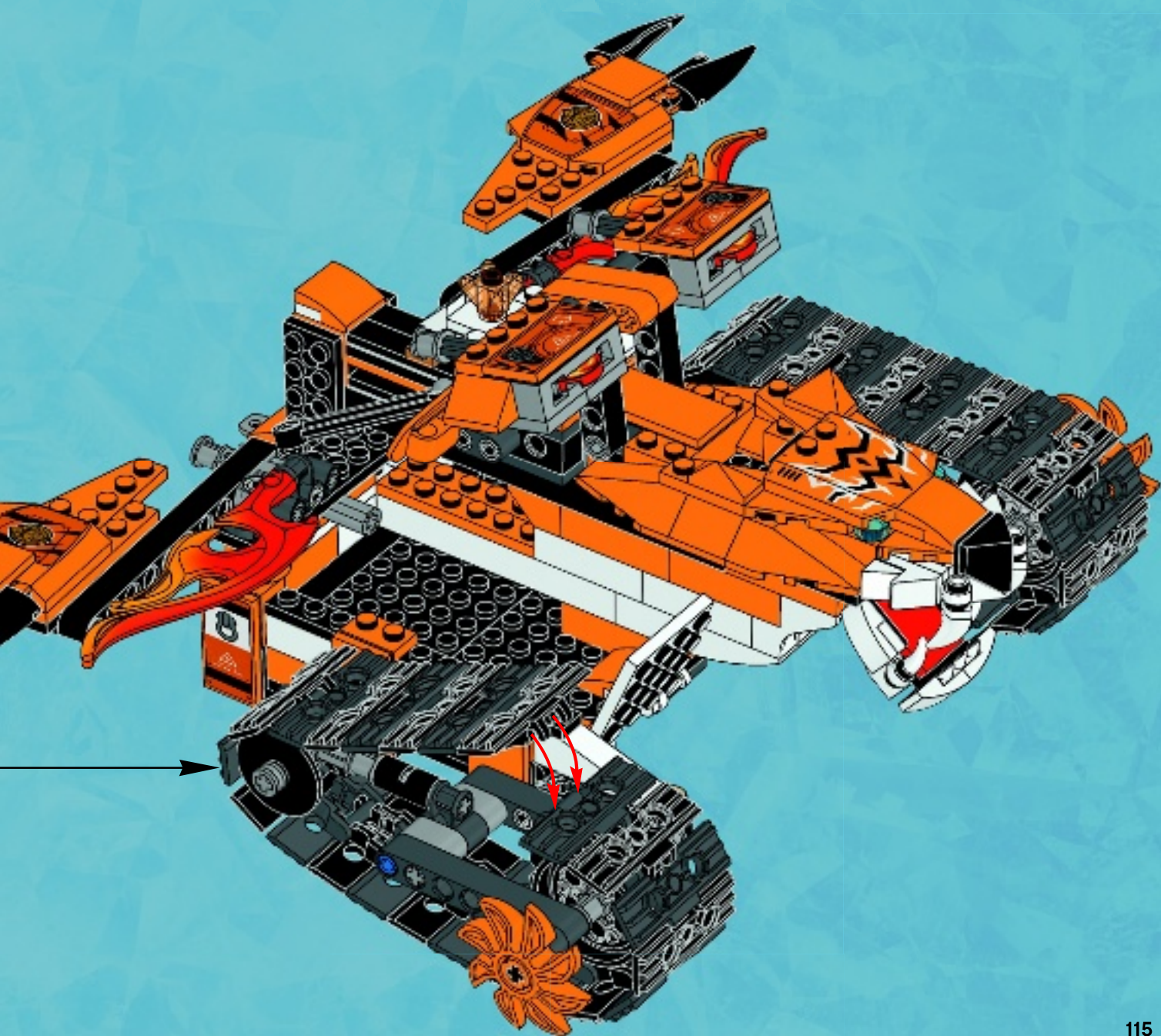



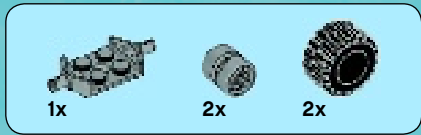

# 61

1



2

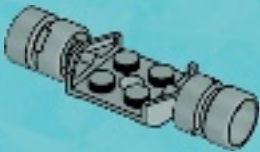

3



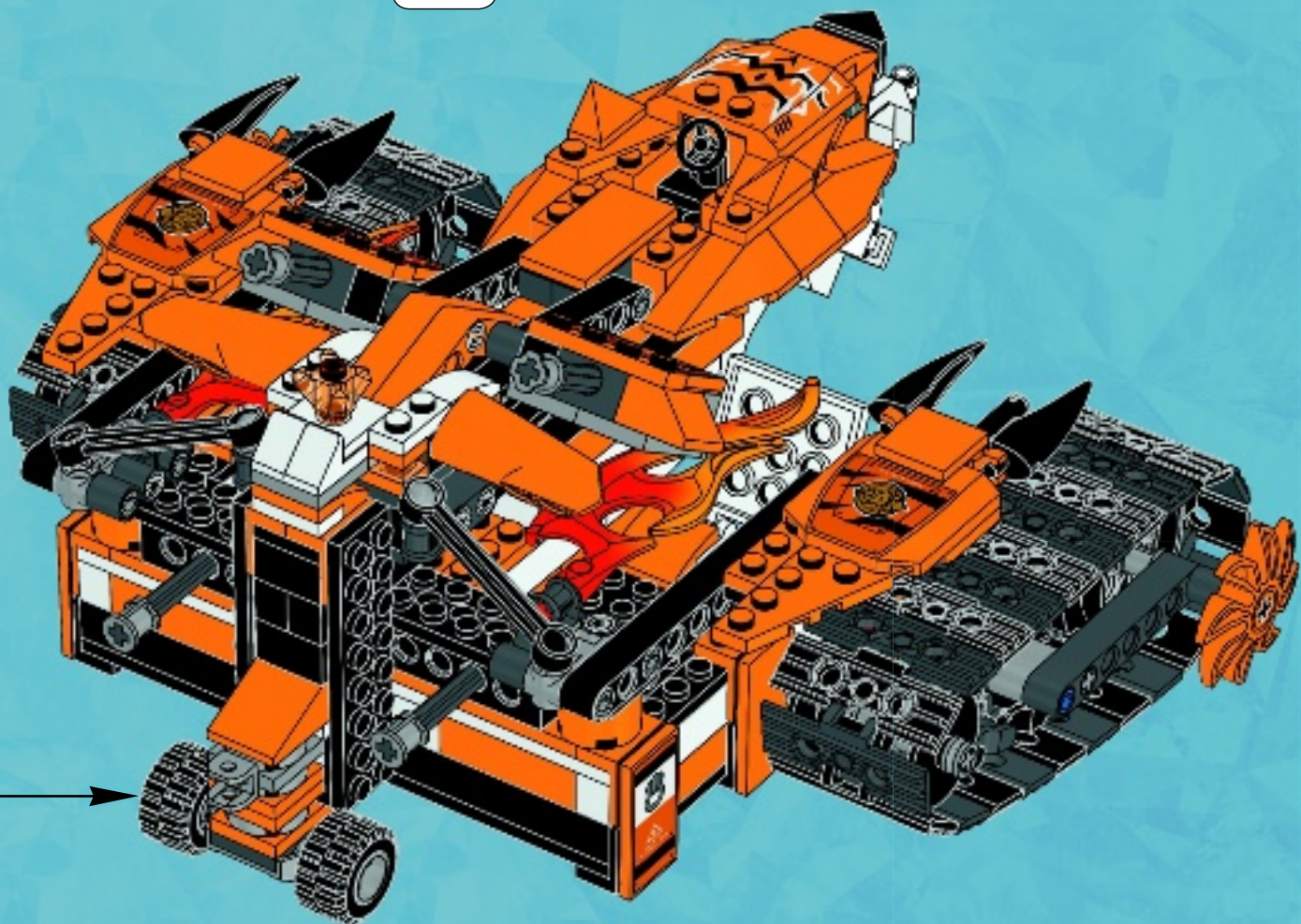

6



1x



1x

1

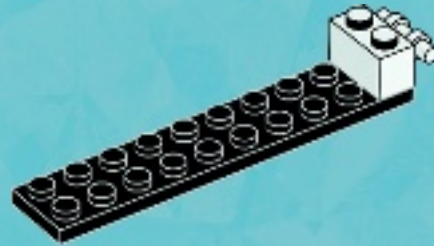



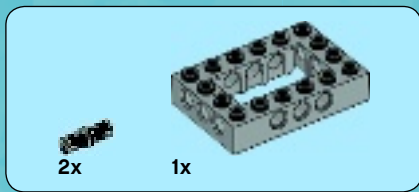

2

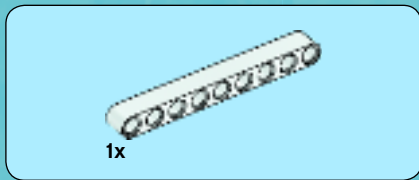
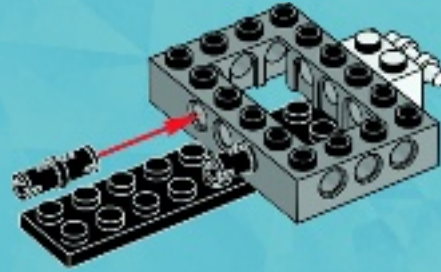

3

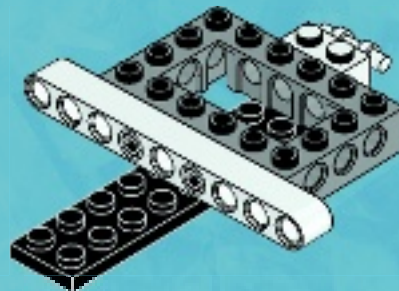

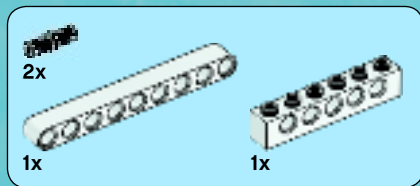

4

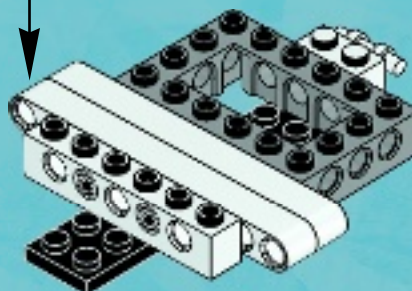
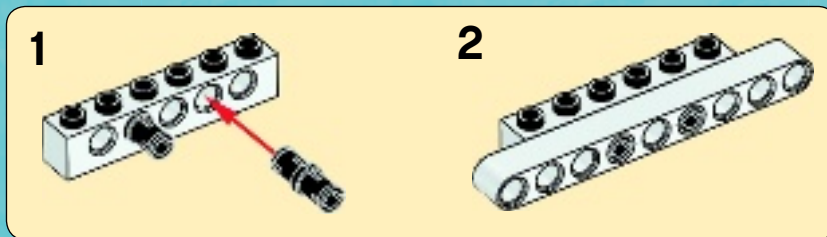

5





1x



2x

# 6



2x



2x

# 7

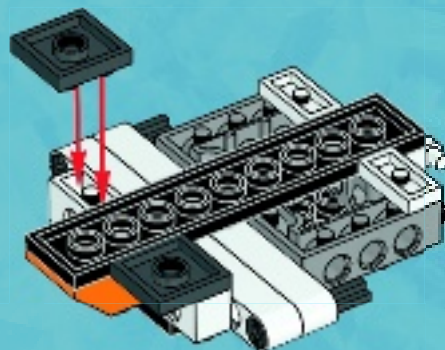





2x

8



1x

9



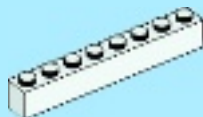

2x

# 10



2x



1x

# 11



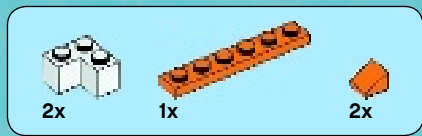

# 12

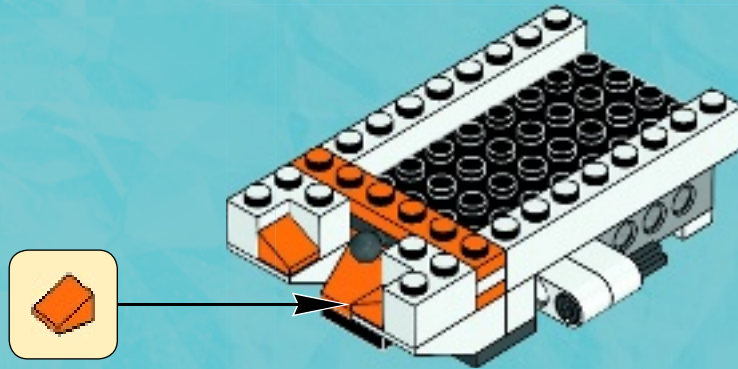

# 13







1x



1x

# 14

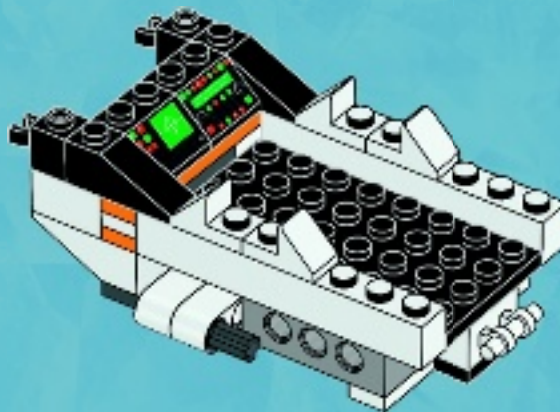

1x



2x



2x

# 15

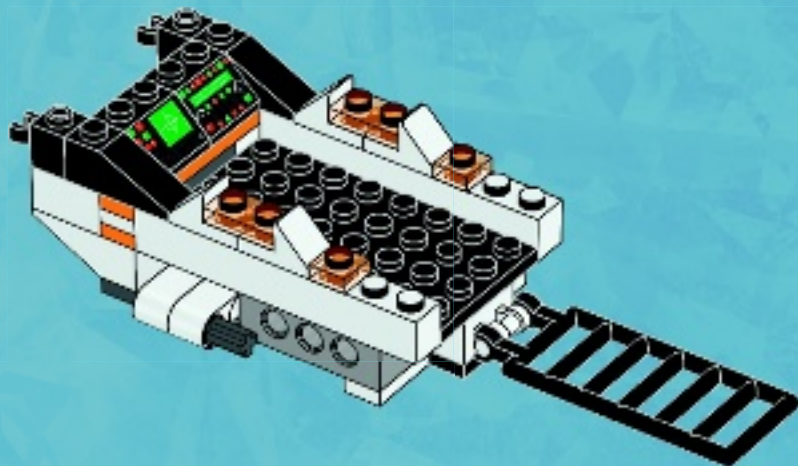



2x

16

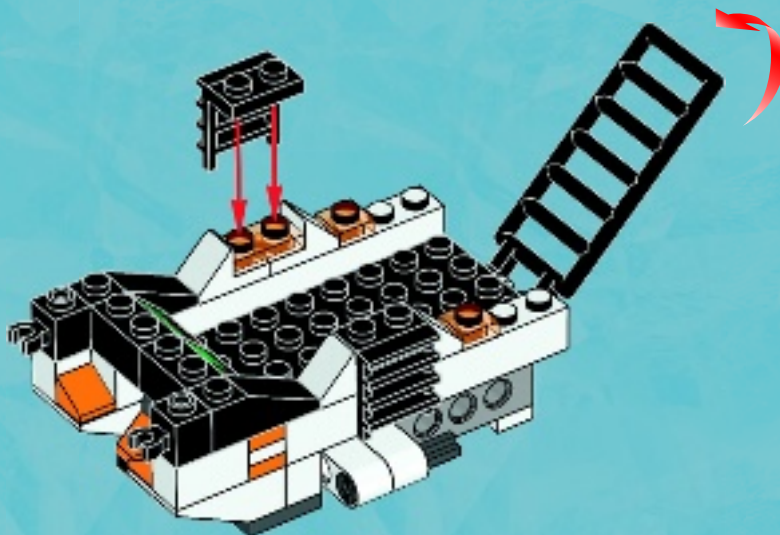

2x



2x



1x

17

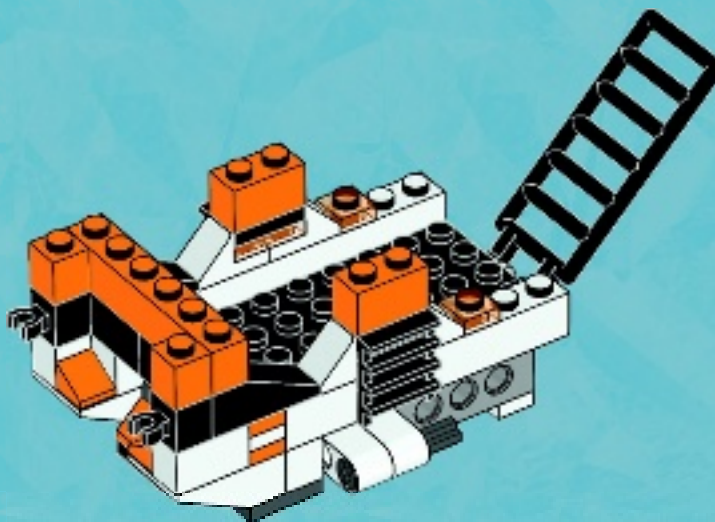

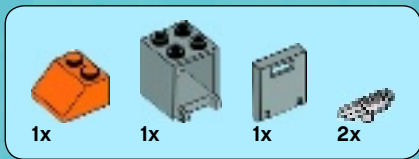

# 18

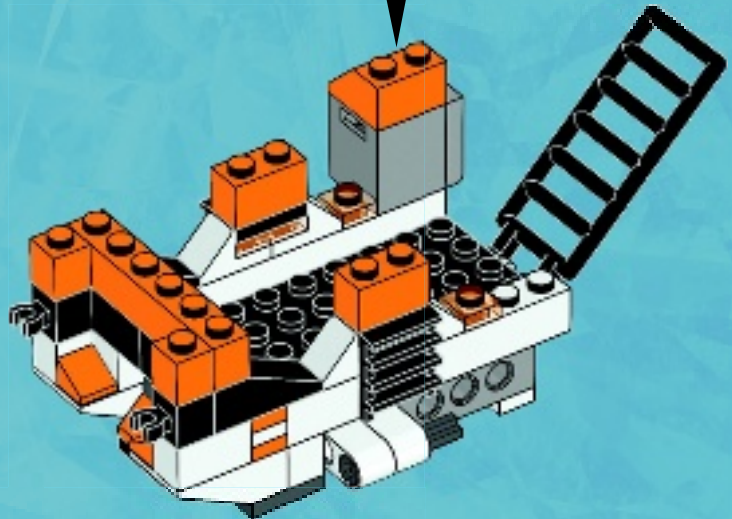
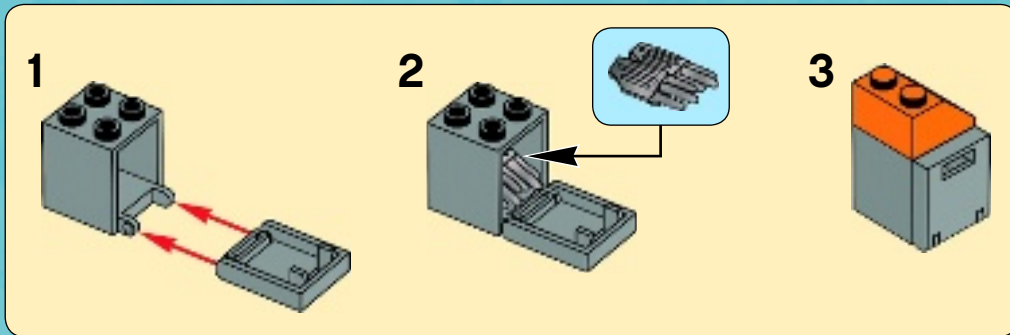



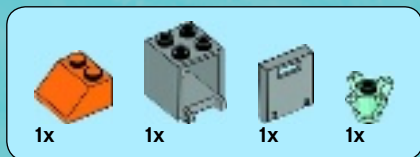

# 19

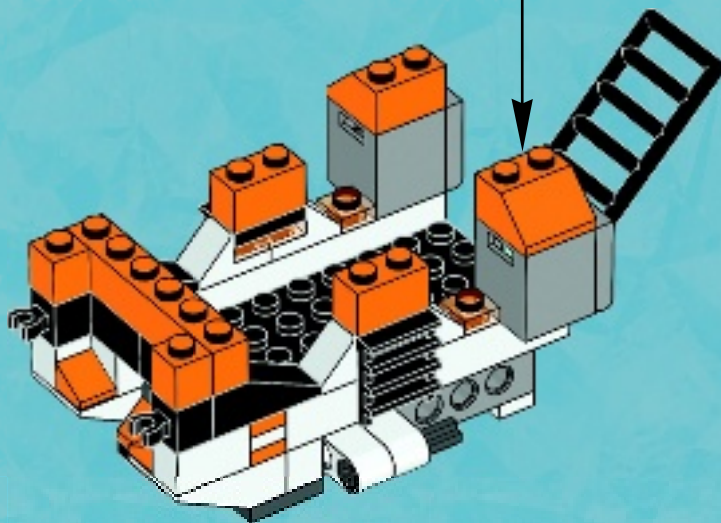
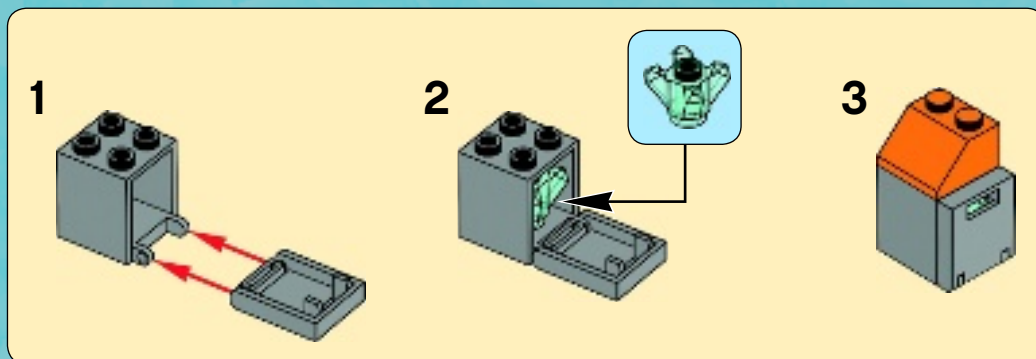



4x



2x

# 20

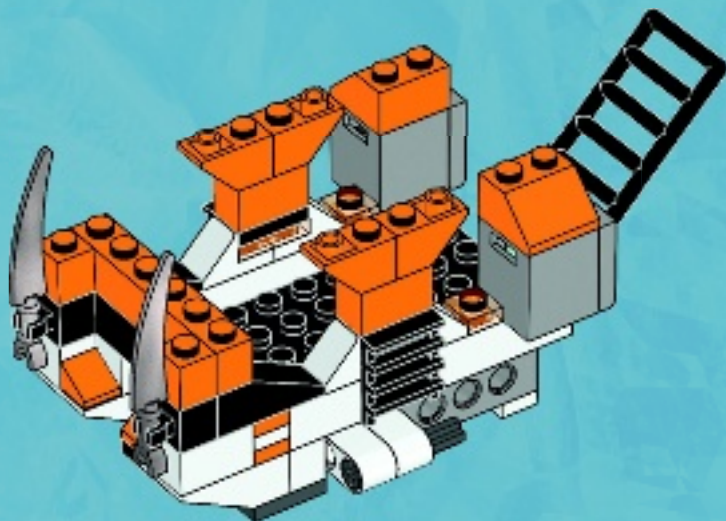

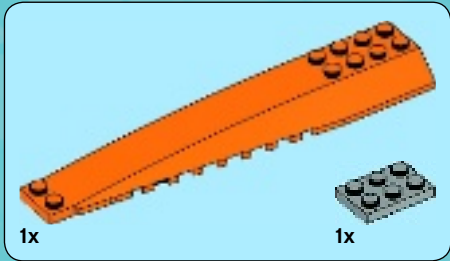
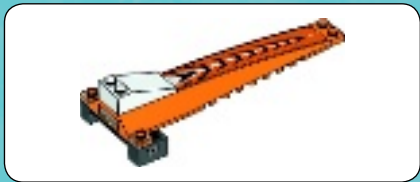

1

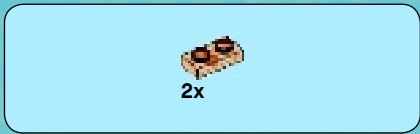
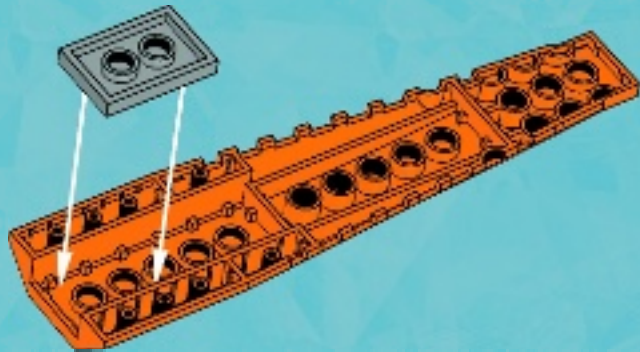

2

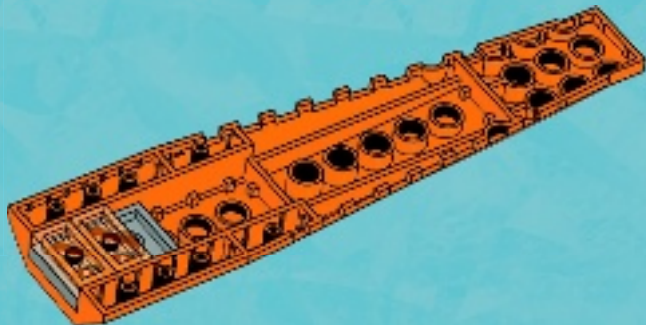





2x



1x

3

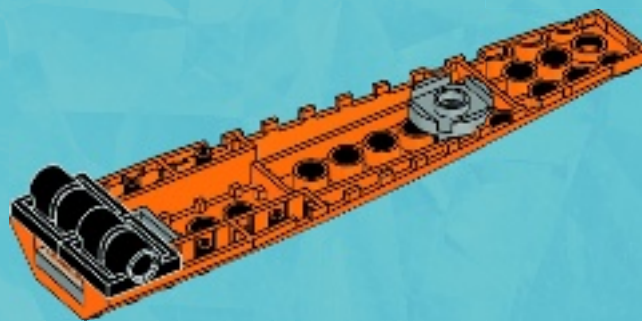

2x

4

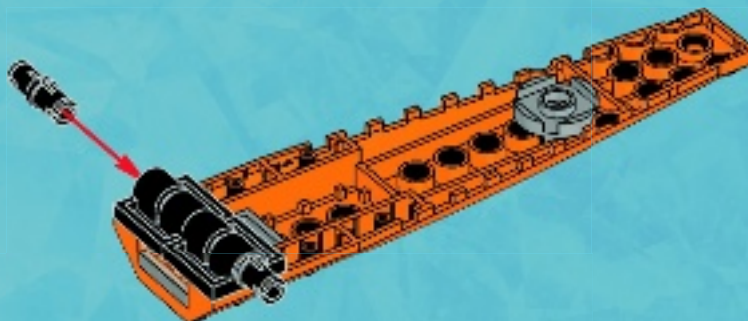



1x



5

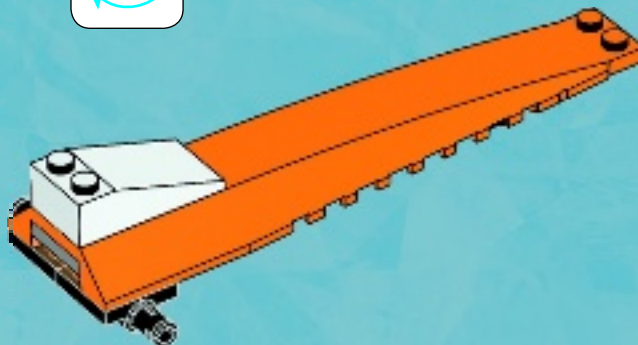

2x

6

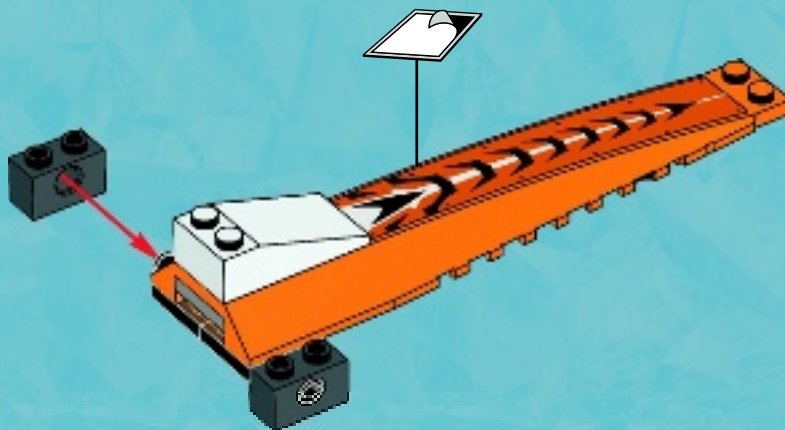



2x

7

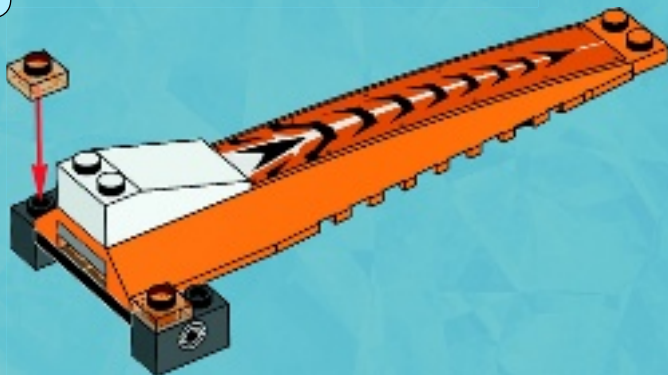

21

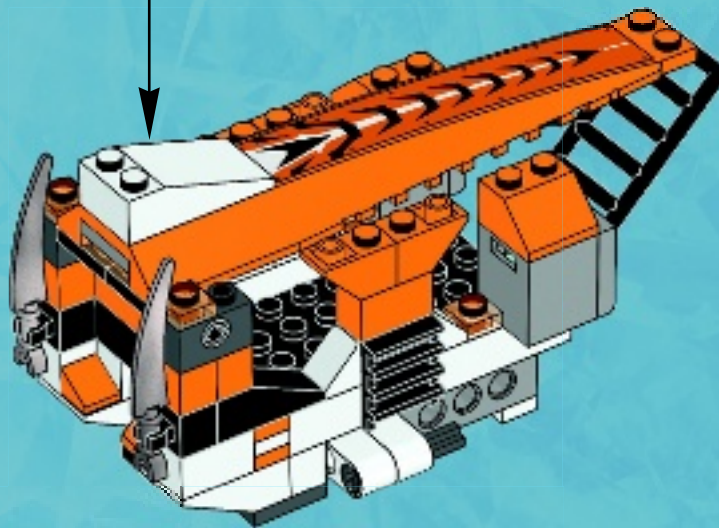





22

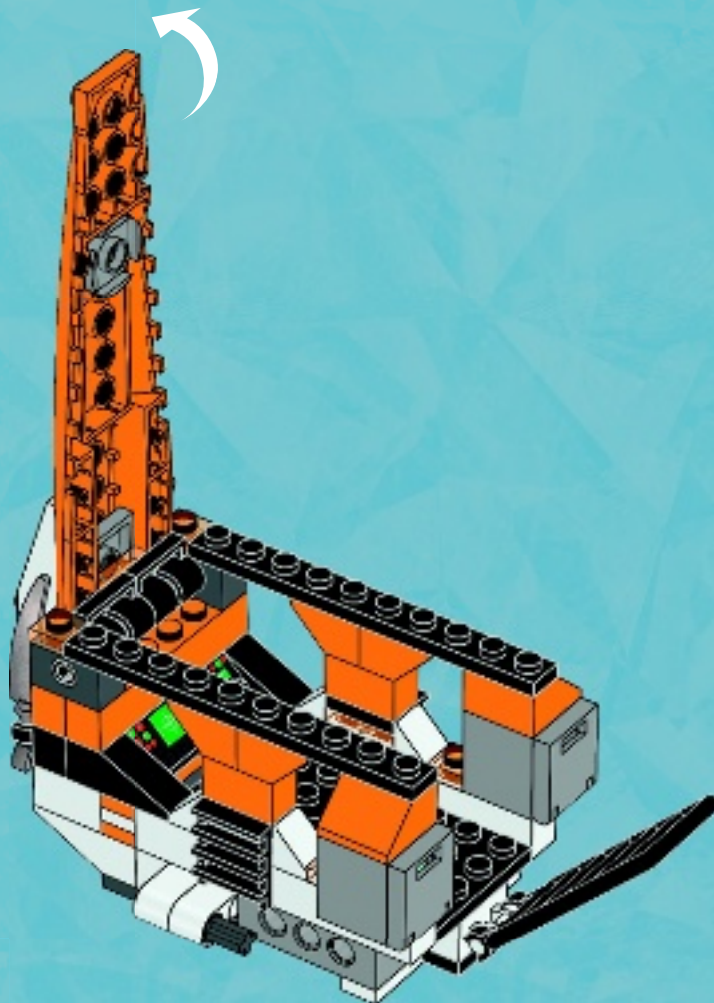

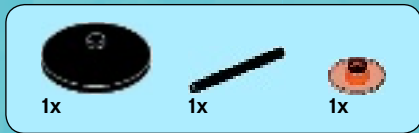

# 23

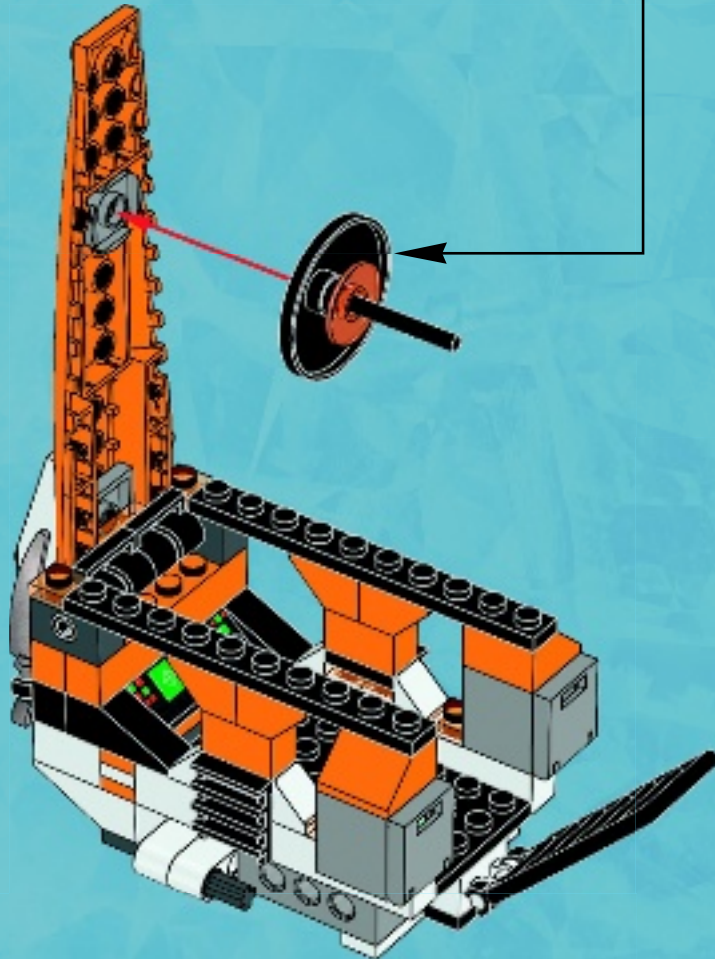
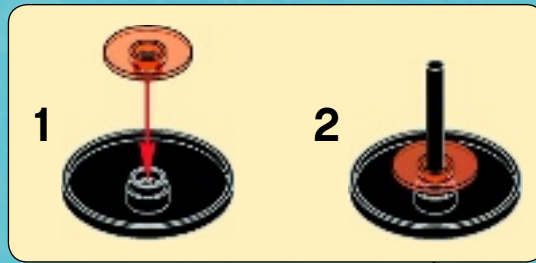



# 24

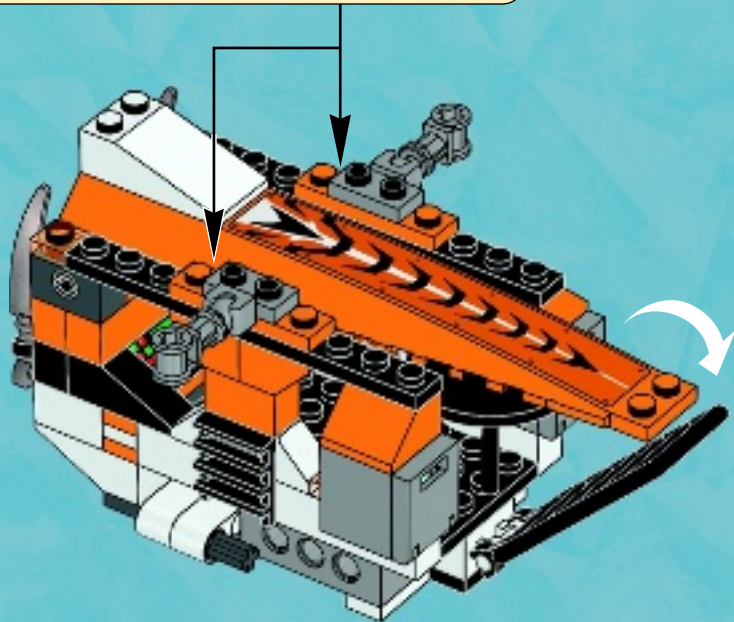





4x

# 25

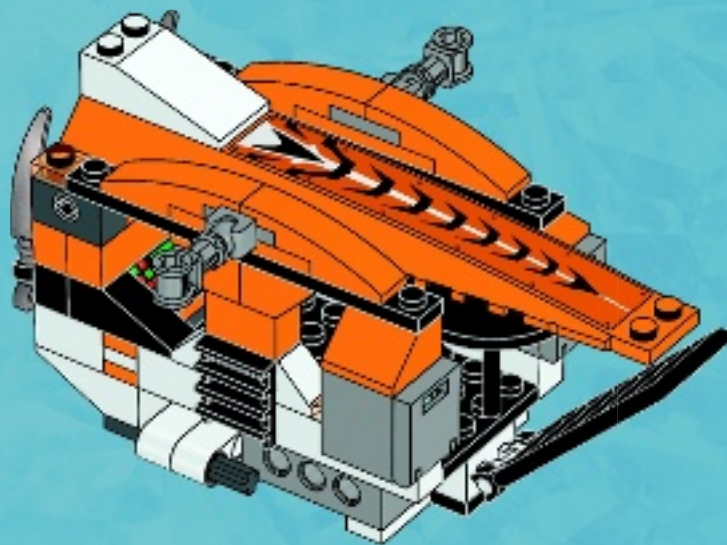



1x



1x

# 26

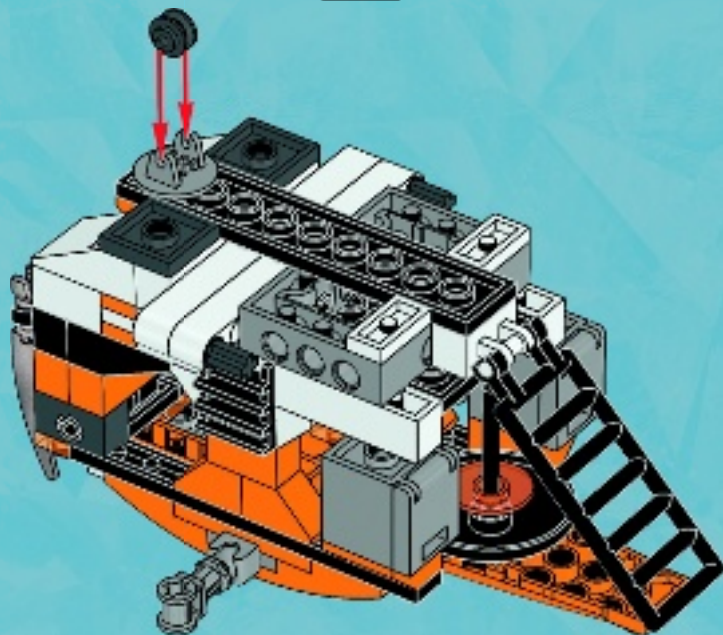



# 27

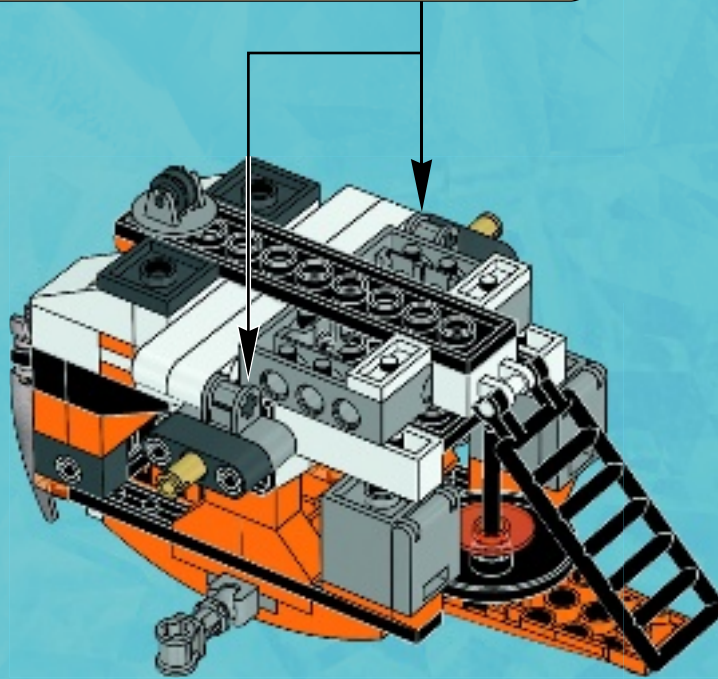
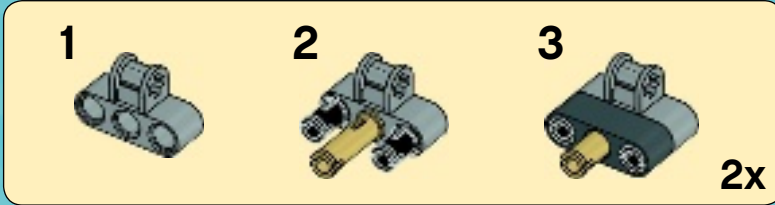





2x

# 28

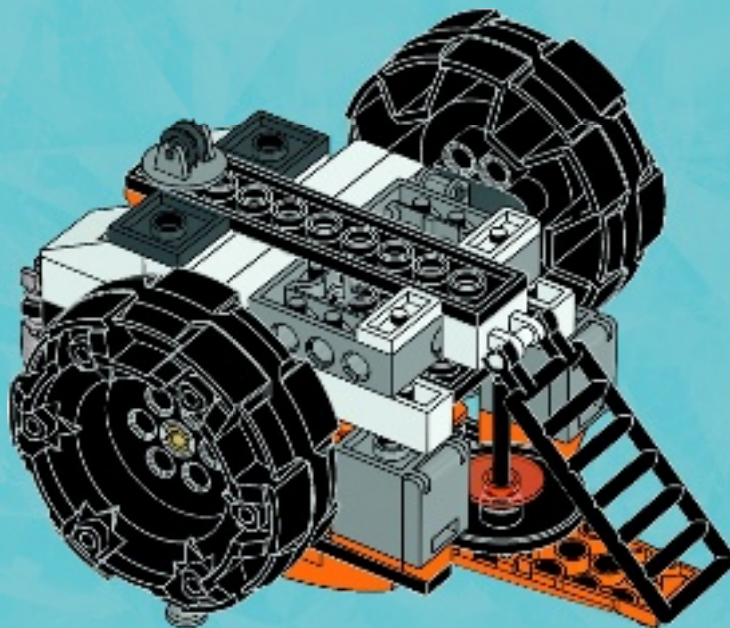

29

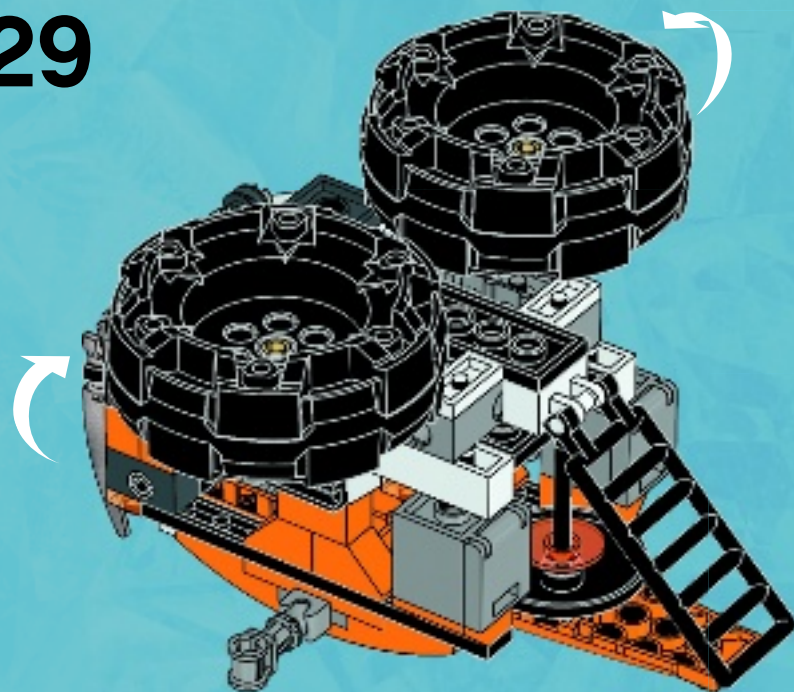



2x



2x



2x

# 30

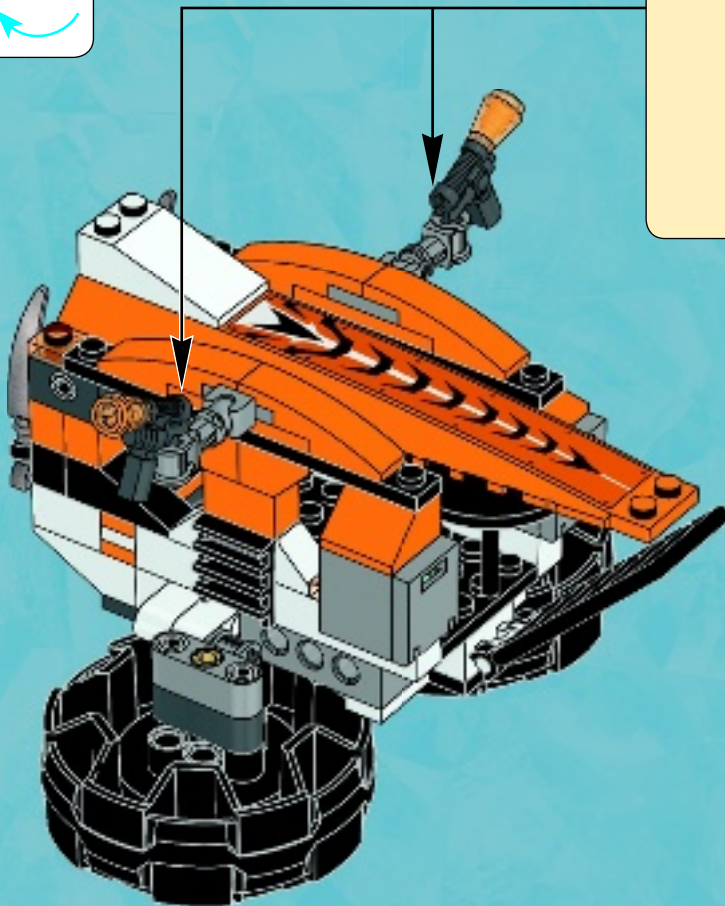

1

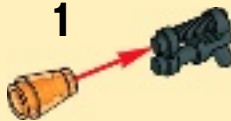

2



2x



31



32

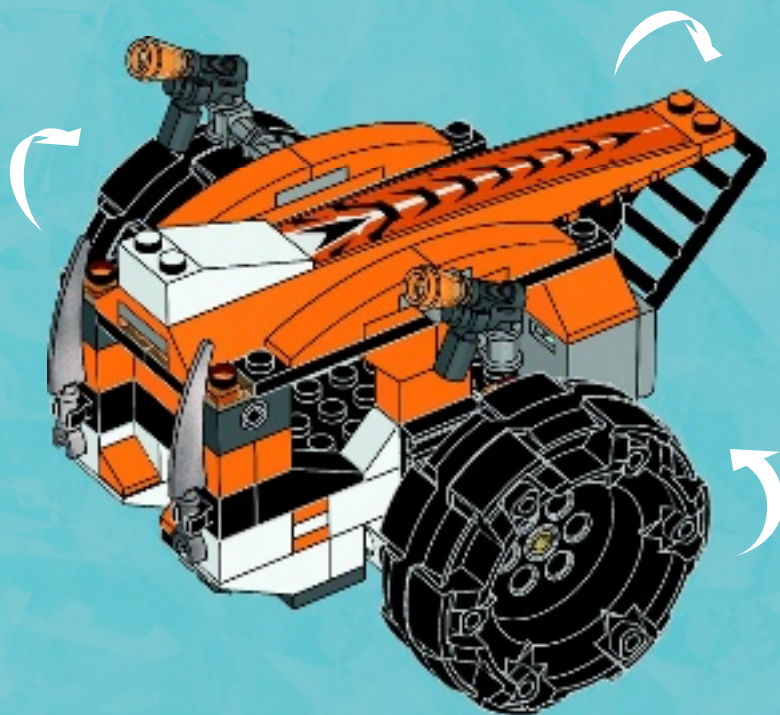



33

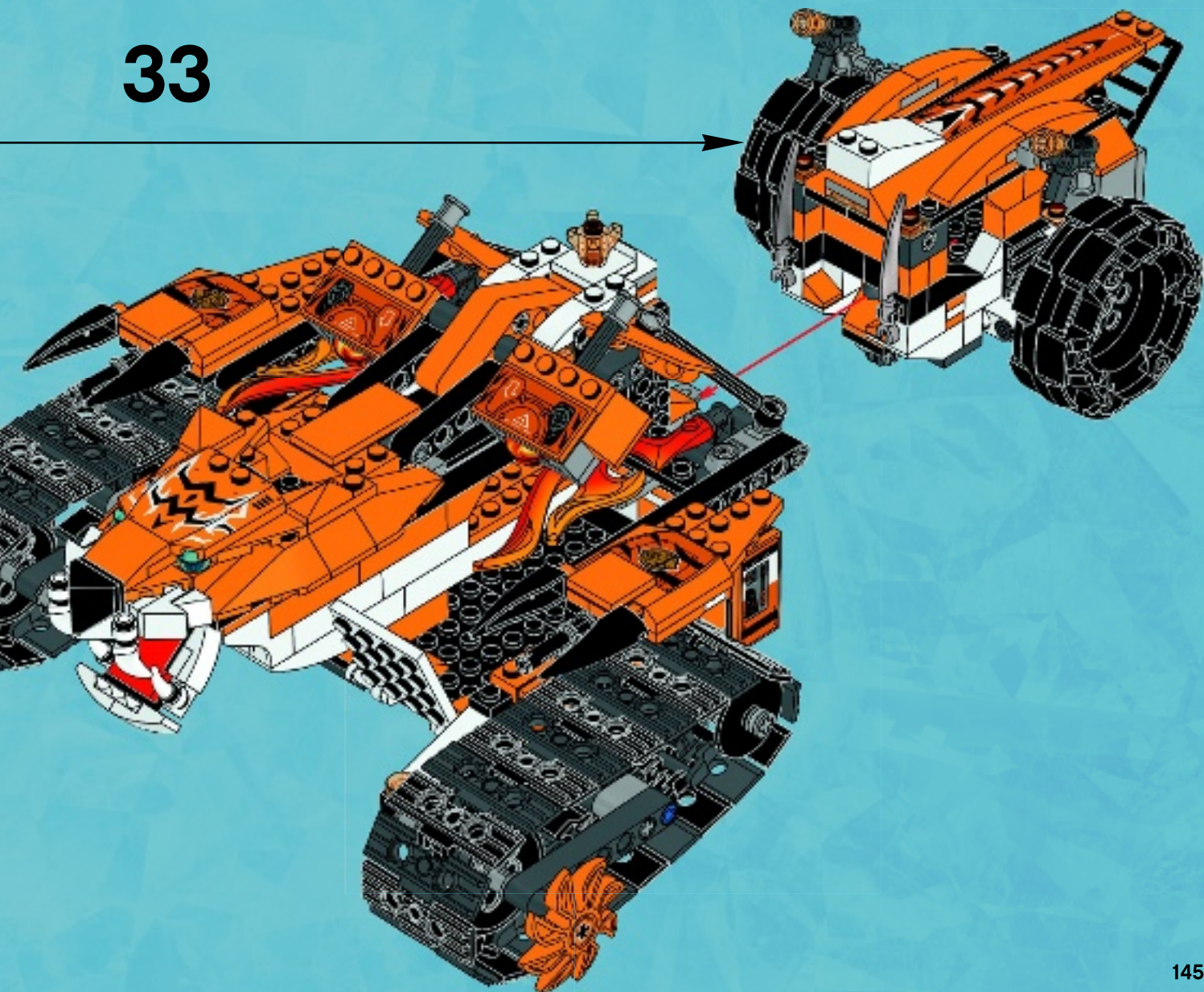





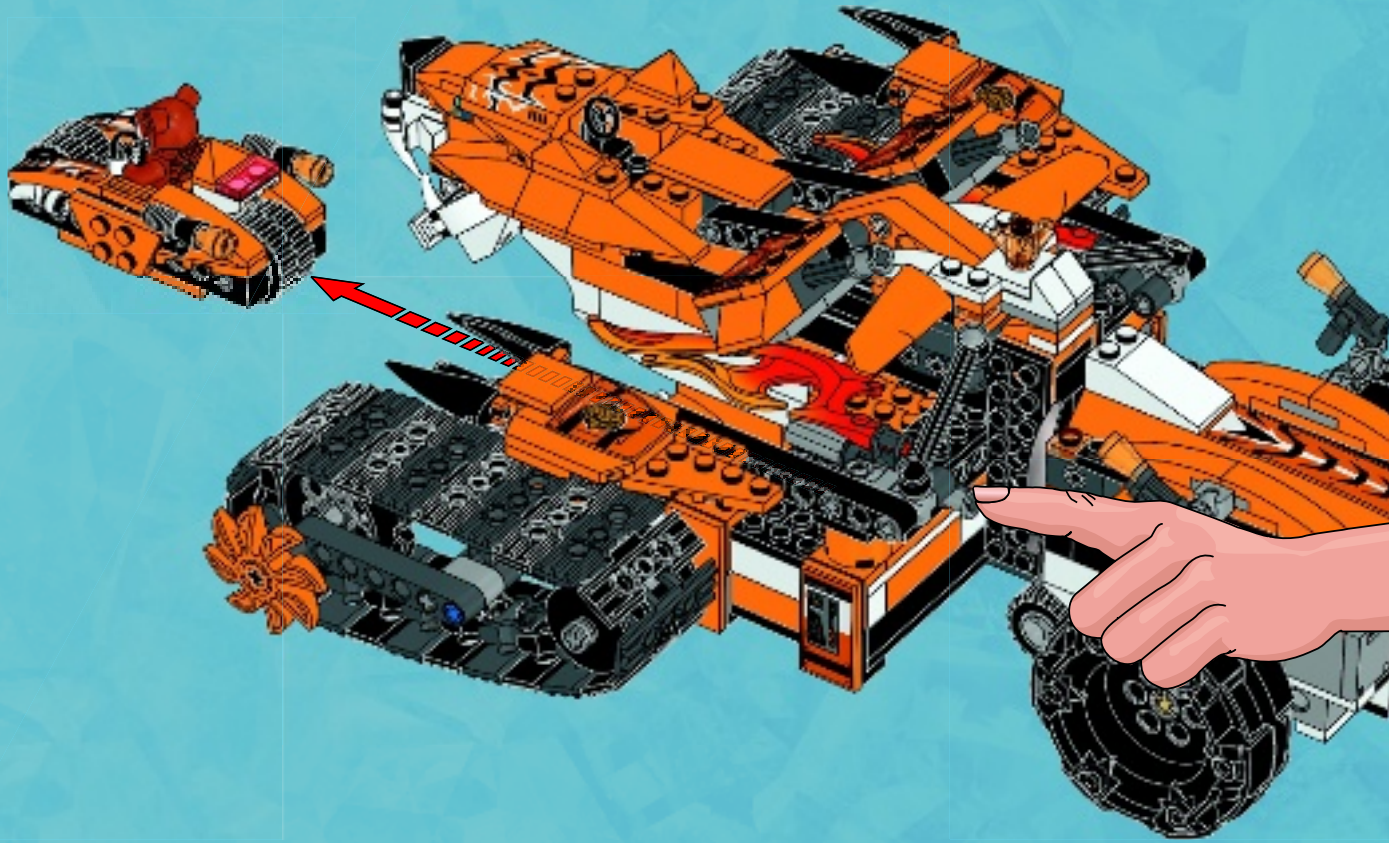
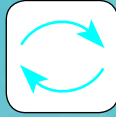





7x  
4514554



3x  
300401



2x  
235701



2x  
300101



2x  
300801



4x  
611201



1x  
389401

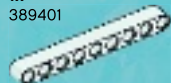

2x  
6001831



2x  
346001



2x  
4160403



2x  
4504369



1x  
6097801



8x  
6069002



2x  
4121932



1x  
303901



3x  
4500469



2x  
4515359

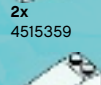

1x  
4143000



6x  
6034044



6x  
4568956

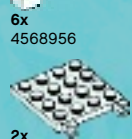

2x  
6030965



13x  
302301



1x  
4565324



1x  
4243812



3x  
4173941



8x  
4632566



2x  
6018774



5x  
4222017



1x  
6073019



1x  
6076594



1x  
6072955



1x  
6070249



1x  
6070289



2x  
4568387



6x  
4566256



2x  
4224792



1x  
6046381



1x  
4140626



1x  
4125554

1x  
6022500



1x  
4530734



3x  
6102613



1x  
6073195



1x  
6074946



2x  
4142865



2x  
4526982



2x  
300326



1x  
4551168



1x  
4295400



2x  
4533771



4x  
3200026



10x  
370126



3x  
389526



3x  
246526

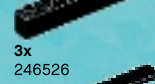

4x  
416226

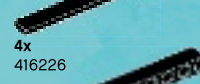

2x  
6029578

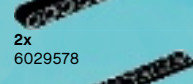

2x  
447726



1x  
303526



1x  
383226



1x  
303626



2x  
4514845

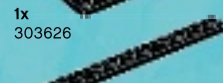

1x  
6001494



2x  
302726



2x  
302726





2x  
4582792



1x  
4220539



2x  
428626



2x  
4142135



2x  
4629921



22x  
6014648



4x  
4550017



1x  
602026



2x  
6019988



4x  
373826



1x  
396026



6x  
6061032



2x  
281726



1x  
4538456



4x  
434926



1x  
400626



1x  
6051527



4x  
6015884



9x  
6000650



8x  
6016172



3x  
6020193



3x  
73081



2x  
4603502



2x  
4184169



23x  
4121715



2x  
6089119



4x  
4119589



2x  
4140801



4x  
4218868



1x  
4140303



2x  
4568644



4x  
4639695



1x  
370626



2x  
370726



2x  
6097662



1x  
6100700



1x  
6102413



1x  
6102909



2x  
6102408



1x  
6102880



1x  
6102899



1x  
6102851



1x  
6102889



3x  
6051920



3x  
6022171



2x  
4124073



1x  
6019570



2x  
6070887



3x  
4183544



2x  
4173805



2x  
4121739



4x  
4118827



6x  
4153827



3x  
4189007



2x  
4141089



6x  
4616279



3x  
4118829



8x  
4118828



1x  
4121742



2x  
4662210



2x  
4662204



1x  
6070110



8x  
6037414



5x  
6025385



2x  
6100879



12x  
6037750



6x  
6067913



4x  
6075084



4x  
4504371



4x  
4125254



1x  
4188771



2x  
4542142



2x  
4662210



1x  
6103469



2x  
6004919



2x  
6004156



4x  
4593773

6

8



**Customer Service**  
**Kundenservice**  
**Service Consommateurs**  
**Servicio Al Consumidor**  
**LEGO.com/service or dial**



00800 5346 5555 :  
 1-800-422-5346 :



# club™



2



3







LEGENDS OF CHIMA™

# CHIMA



70223



70224

THE ULTIMATE  
BATTLE  
FOR CHIMA





LEGENDS OF

# CHIMA

TM

70231

70223

70224

70232

70229

70230



70229



70230



70231



70232

[LEGO.COM/CHIMA](http://LEGO.COM/CHIMA)





LEGENDS OF

TM

# CHIMA



**WORRIZ**

70220



**GORZAN**

70222



**CROCKENBURG**

70231



**FLINX**

70221

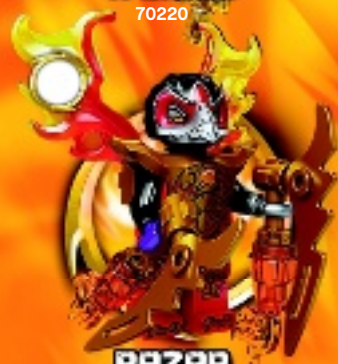

**RAZAR**

70223



**ERIS**

70224



**LI'ELLA**

70229

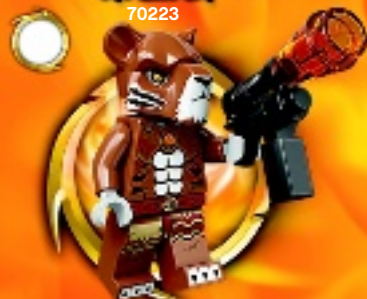

**TAZAR**

70224



**BULKAR**

70223



**TORMAK**

70222





**SIR FANGAR**  
70224



**SIBRESS**  
70224



**ICEBITE**  
70223



**ICERLOT**  
70230



**SIROX**  
70232



**SYKOR**  
70222



**ICEPAW**  
70223



**STRAINOR**  
70220



**VOOMVOOM**  
70221



**TRAKKAR**  
70224



**BREEZOR**  
70224

# WIN

GO TO [WWW.LEGO.COM/PRODUCTFEEDBACK](http://WWW.LEGO.COM/PRODUCTFEEDBACK) AND  
GIVE US YOUR SHORT **FEEDBACK** ABOUT THIS  
LEGO® SET FOR A CHANCE TO WIN  
A COOL LEGO PRIZE.

## LEGO.com/productfeedback

### GEWINNE



Erzähle uns auf  
[www.LEGO.com/productfeedback](http://www.LEGO.com/productfeedback)

*etwas über die Erfahrungen, die du mit  
diesem LEGO® Set gemacht hast, und  
sichere dir die Chance auf einen coolen  
LEGO Preis!*

### GAGNE



Rends-toi sur  
[www.LEGO.com/productfeedback](http://www.LEGO.com/productfeedback)

*et donne-nous quelques commentaires  
sur ce produit LEGO® pour avoir une  
chance de gagner un prix LEGO !*

### GANA



Visita  
[www.LEGO.com/productfeedback](http://www.LEGO.com/productfeedback)

*y envíanos tu opinión acerca de este set  
LEGO®. ¡Participarás en el sorteo de un  
premio LEGO!*

### 获取奖品



登录  
[www.LEGO.com/productfeedback](http://www.LEGO.com/productfeedback)

*给出关于此乐高®套装的简短反馈，  
就有机会获得炫酷乐高高奖品*