



CREATOR

31029



LEGO.com/creator

1



2



3



4





1x



1x

1

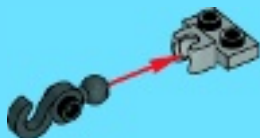

2x

2





1x

3



4



2x

4





1x



2x



2x

5

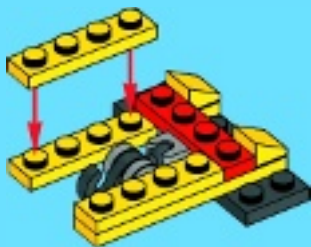

2x



2x

6





2x



4x

7

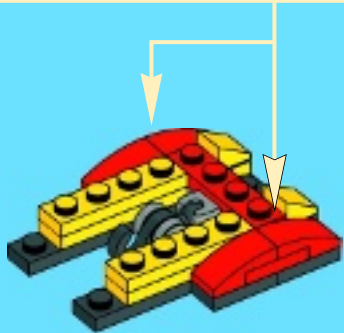
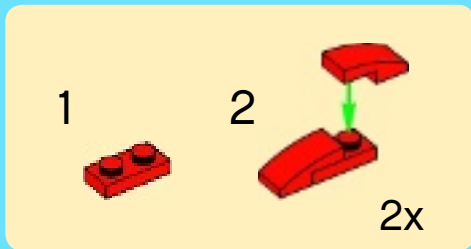

1x



1x

8

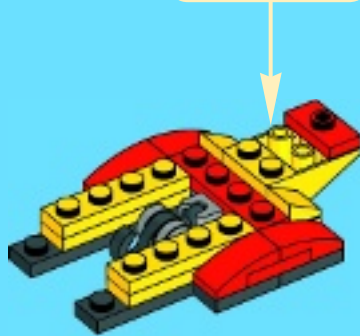



2x



2x

9



1x



1x

10

1

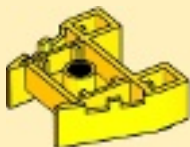

2

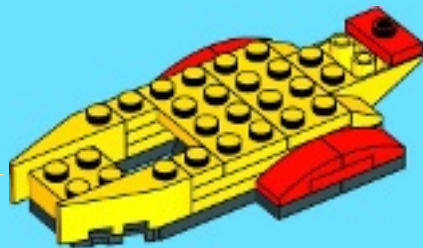



1x

11

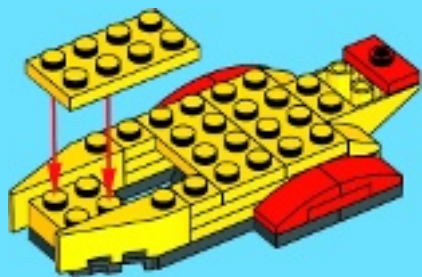

8



2x



1x



1x

12

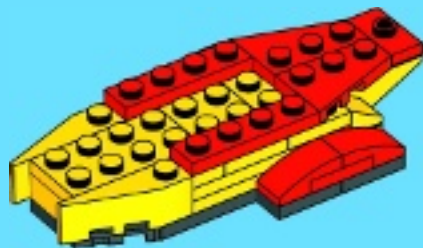



1x

13



1x



1x

14

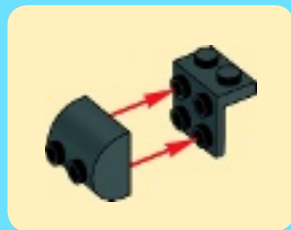



1x



1x



1x

15

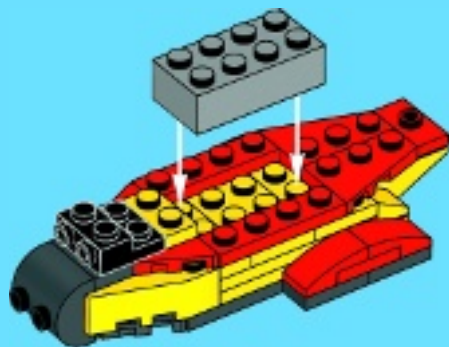

10



4x



2x

16



2x





4x



2x

17

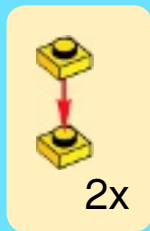

2x



1x



1x

18





2x



2x

19

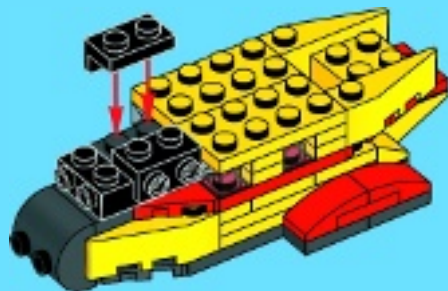



2x



2x



2x

20

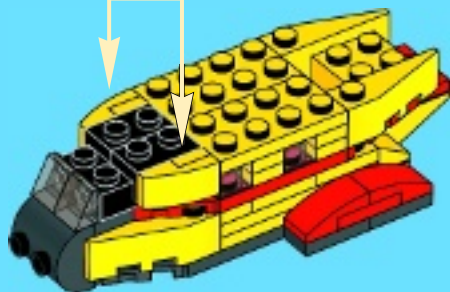
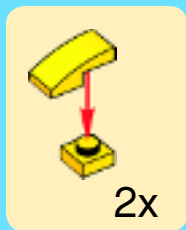

2x



1x

21

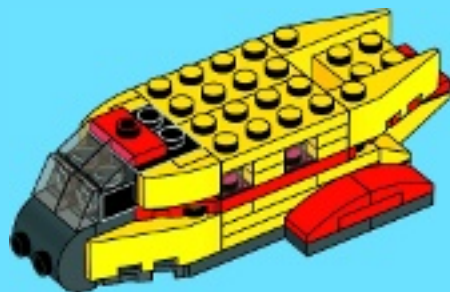



1x



1x

1

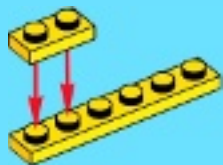

1x



1x

2

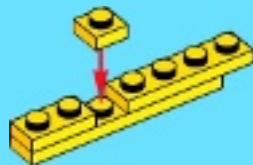



1x



1x

3

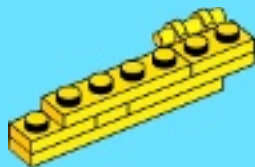

1x

4

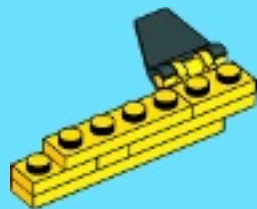



1x



1x



1x

5

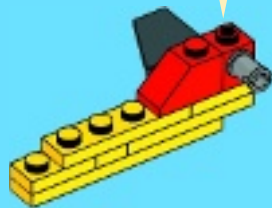
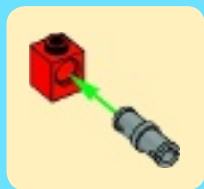

16



1x

6



22

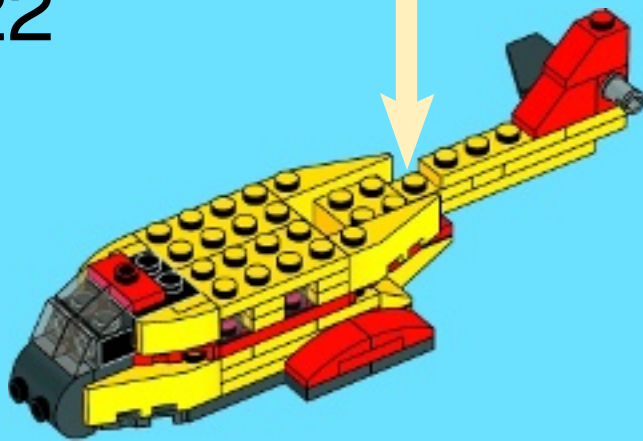



1x

23





1x

24

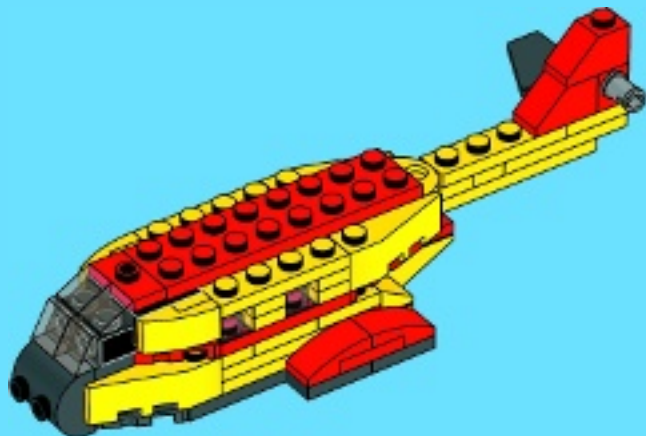



2x



1x

25

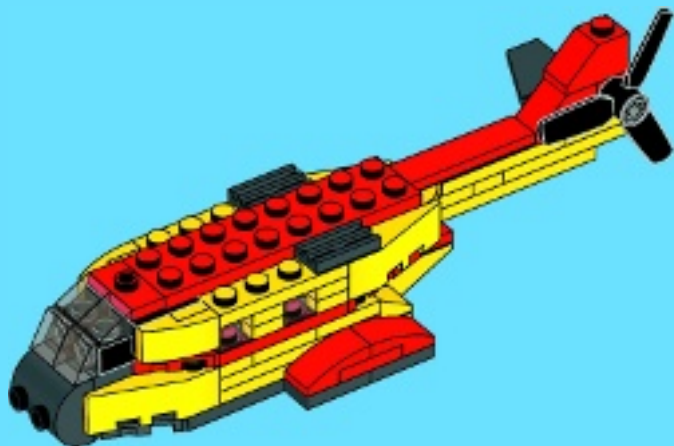



2x



1x

26

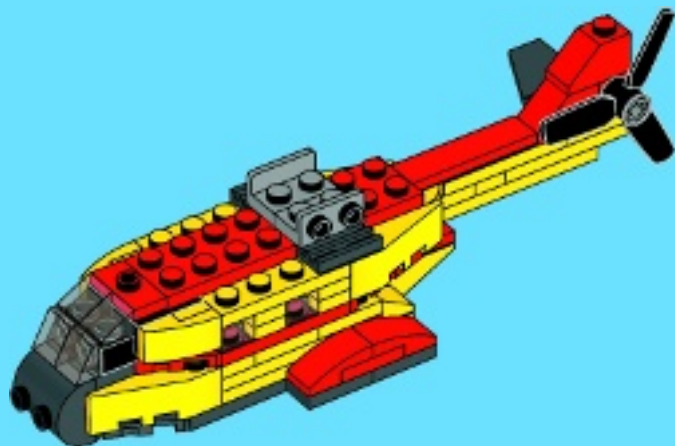



2x



1x

27





1x



1x



1x

28

1



2



3

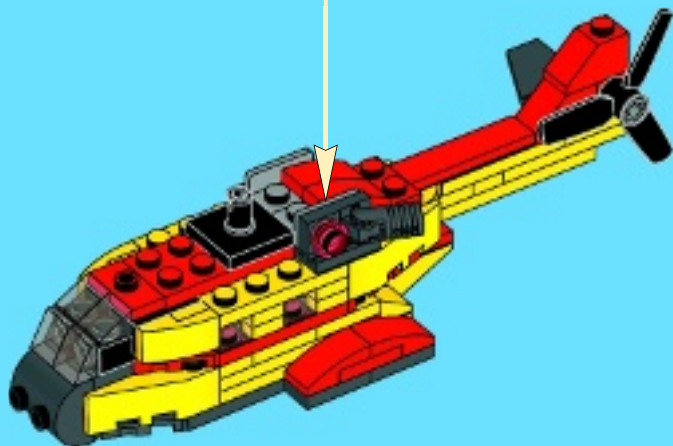



1x



1x



1x

1



2



3



29





2x



2x

30

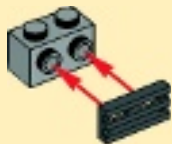

2x

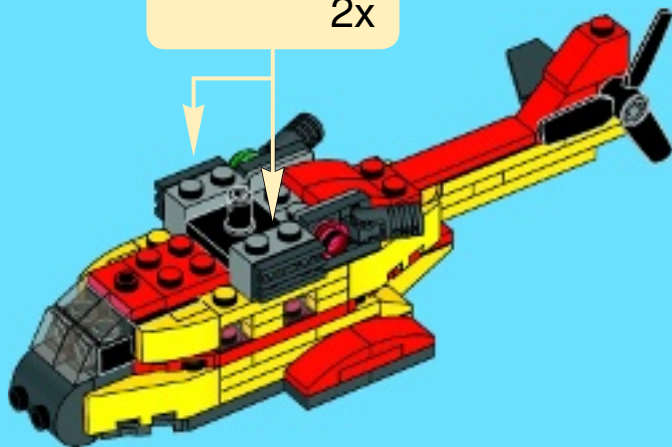



2x



2x

31

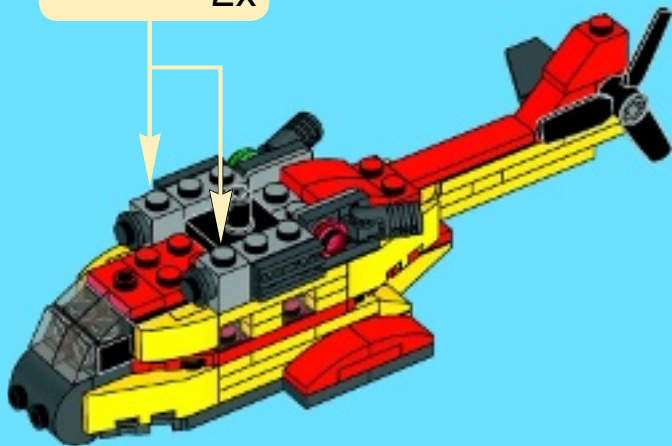
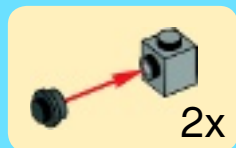



1x



2x

32

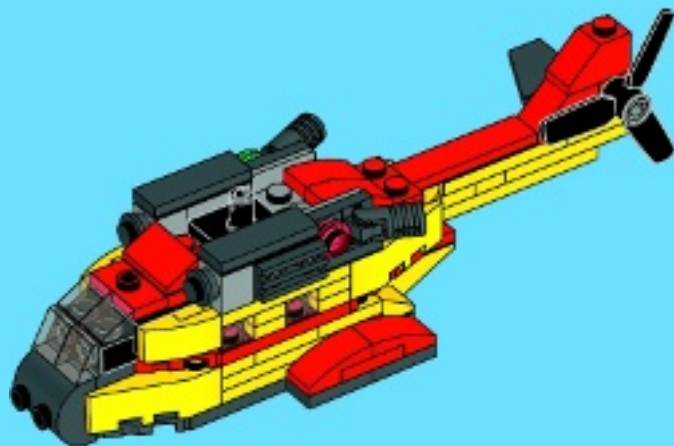



3x



3x

33



3x

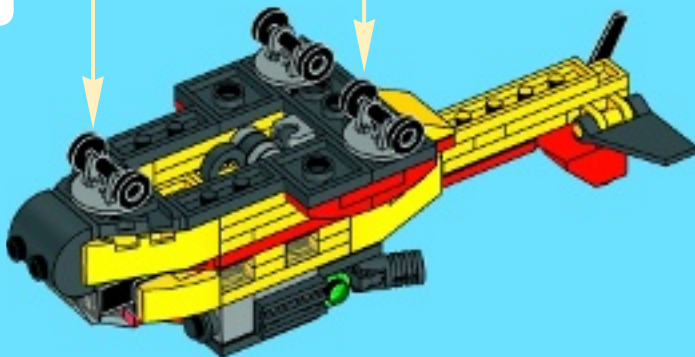



1x

34

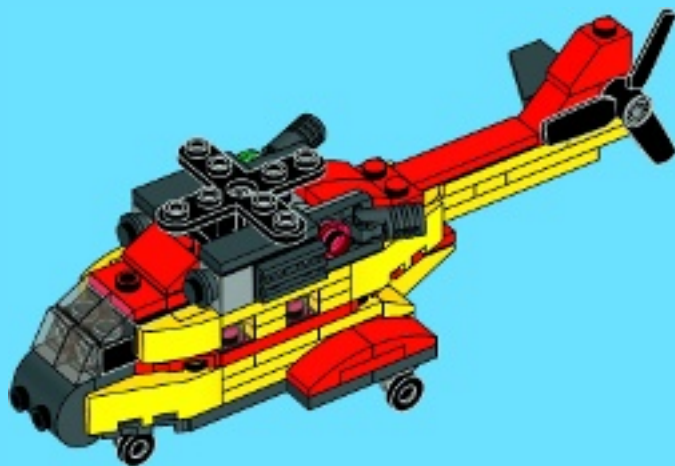



4x



4x



4x

35

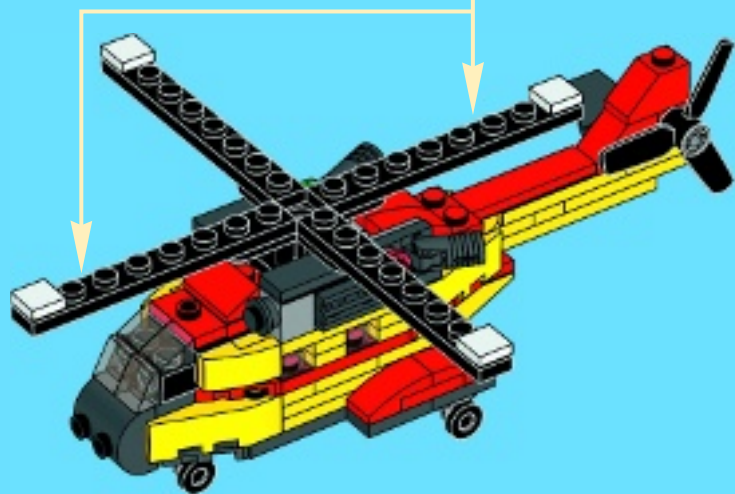



1x



1x

36

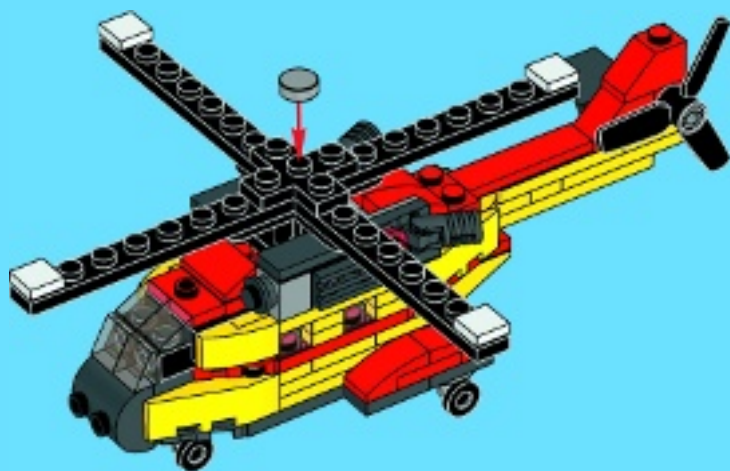

3



4



5



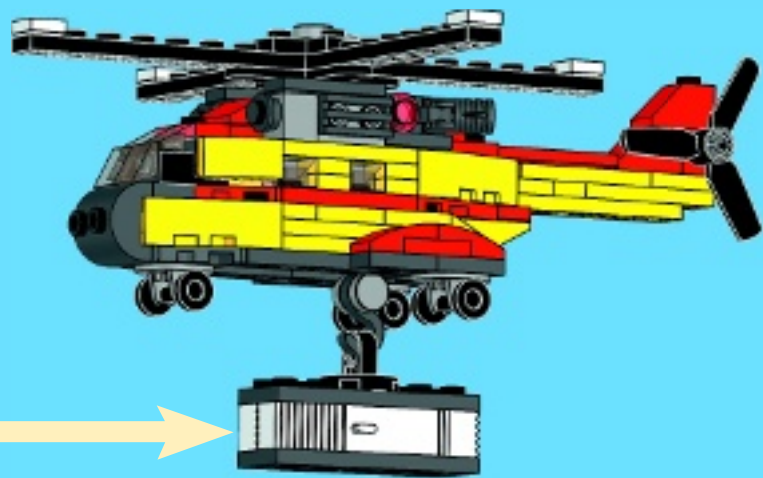



3x
287701



4x
307001



1x
4537987



1x
4527637



2x
6092565



1x
654121



1x
4651524



6x
6029946



2x
302321



1x
243121



3x
371021



1x
4180504



1x
4180533



1x
6023770



1x
303421



2x
4121934



2x
6029947



1x
374724



2x
302324



4x
371024



1x
4140587



1x
4188313



5x
302024



2x
4264028



3x
366624



13x
302424



2x
4504381



1x
6052126



1x
6010831



1x
4258354



1x
4599984



1x
247926



4x
346026



3x
249626



1x
6097283



2x
6016172



1x
4211093



3x
4211094



2x
4211133



2x
4568734



1x
4215387



2x
4210726



4x
4210631



1x
4212529



1x
6048854



3x
4211002



1x
4527082



2x
4210695



2x
4210633



1x
3005741



1x
3005748



8x
4244368



1x
4211385



2x
6015344



2x
6004990



3x
4650260



3x
4211373



1x
4211807



2x
4558953



1x
6043656

Customer Service

Kundenservice

Service Consommateurs

Servicio Al Consumidor

LEGO.com/service or dial



: 00800 5346 5555

: 1-800-422-5346

WIN

GO TO WWW.LEGO.COM/PRODUCTFEEDBACK AND
GIVE US YOUR SHORT **FEEDBACK** ABOUT THIS
LEGO® SET FOR A CHANCE TO WIN
A COOL LEGO PRIZE.



LEGO.com/productfeedback

GEWINNE



Erzähle uns auf
www.LEGO.com/productfeedback

etwas über die Erfahrungen, die du mit
diesem LEGO® Set gemacht hast, und
sichere dir die Chance auf einen coolen
LEGO Preis!

GAGNE



Rends-toi sur
www.LEGO.com/productfeedback

et donne-nous quelques commentaires
sur ce produit LEGO® pour avoir une
chance de gagner un prix LEGO !

GANAN



Visita
www.LEGO.com/productfeedback

y envíanos tu opinión acerca de este set
LEGO®. ¡Participarás en el sorteo de un
premio LEGO!

获取奖品



登录
www.LEGO.com/productfeedback

给出关于此乐高®套装的简短反馈，
就有机会获得炫酷乐高高奖品

LEGO and the LEGO logo are trademarks of the/son des marques de commerce du/son marcas registradas de LEGO Group. ©2015 The LEGO Group.

6112297 / 6112304



CREATOR

31029



LEGO.com/creator



1

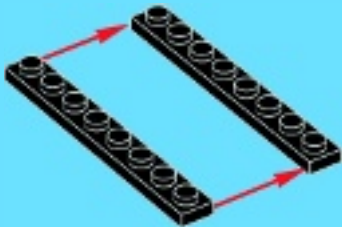

2



2



3

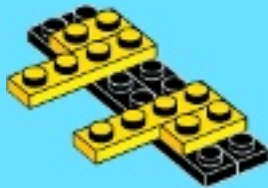



4x

4

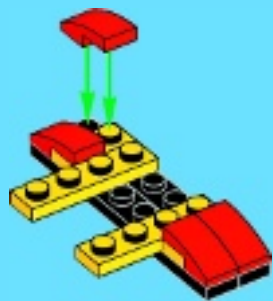

2x

5

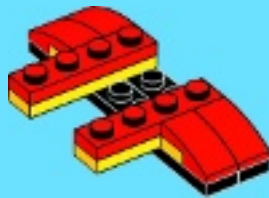



1x



1x

6



1x

7



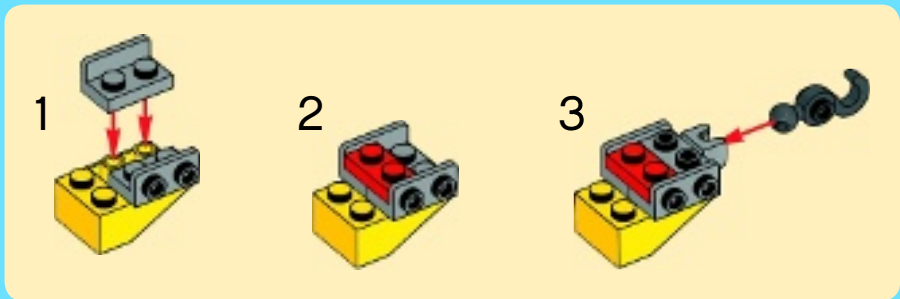

8





1x



2x

9





4x



2x

10



2x

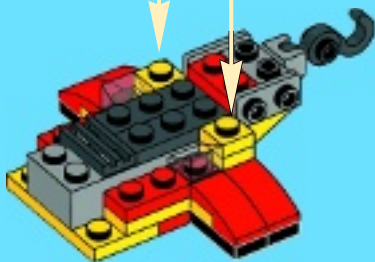

4x



2x

11



2x

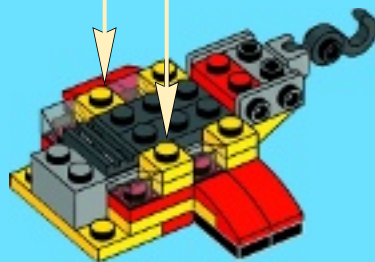



1x



1x

12

1

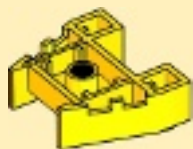

2





2x



2x

13



2x





1x



1x

14



10



2x

15





2x

16



2x

1x

17





2x



1x

18



12



1x

19





1x

1



1x

2



3

1x



4

1x



1x

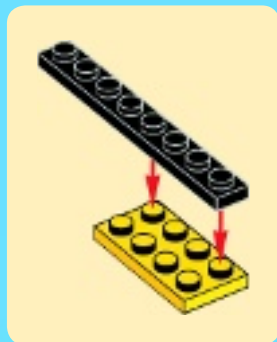
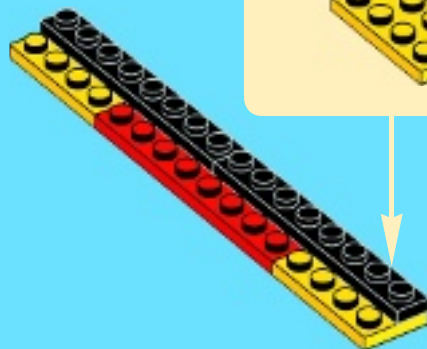



2x

5

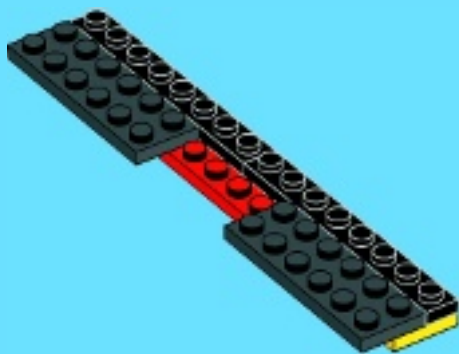

2x

6

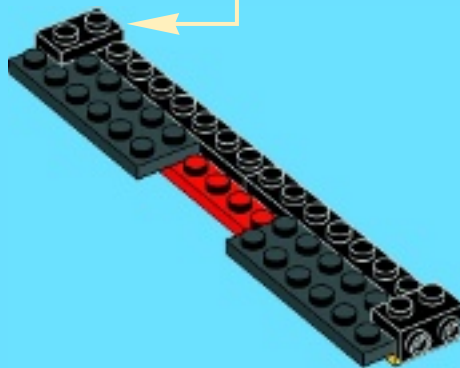



2x

7

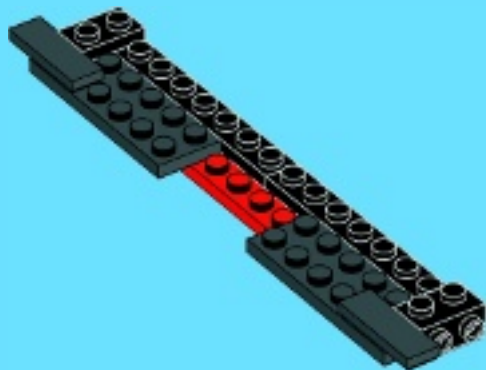

16



1x



1x

8

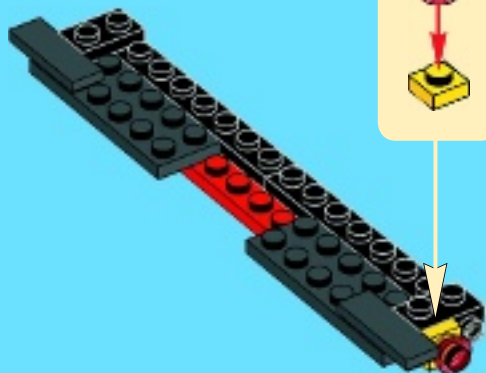



1x



1x

9

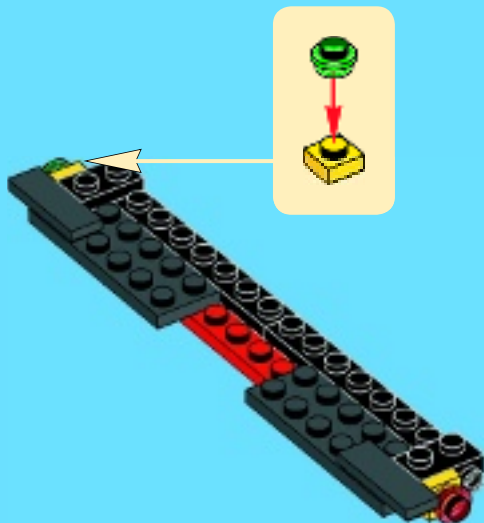

2x

10

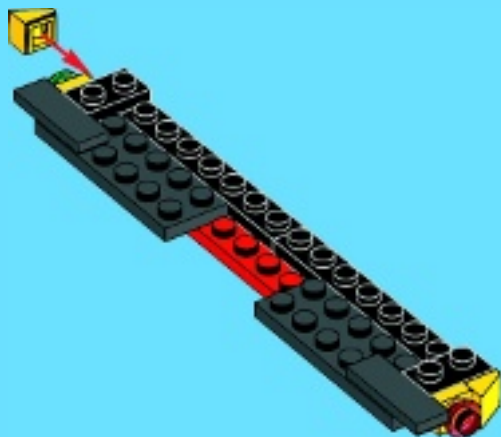



2x



1x

20





3x



3x



3x

21

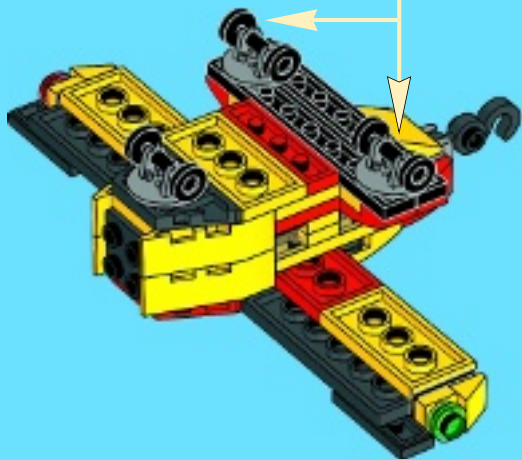

1x

1





1x

2



1x



1x

3

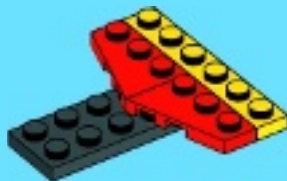



1x



2x

4



1x

5





1x



1x

6



1x

7





22

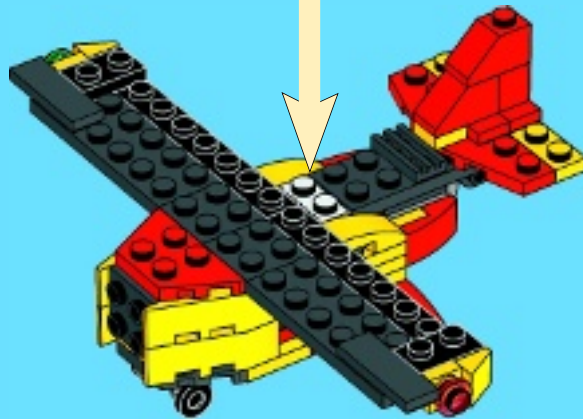



2x

23





2x



2x

24



1x

25





1x



1x

26

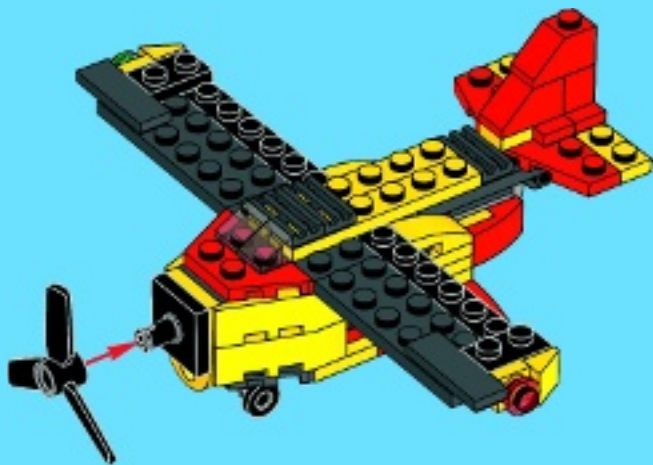



1x



1x



1x



1x



2x

27

1



2



3

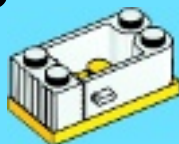

4



5





CREATOR

31029



LEGO.com/creator

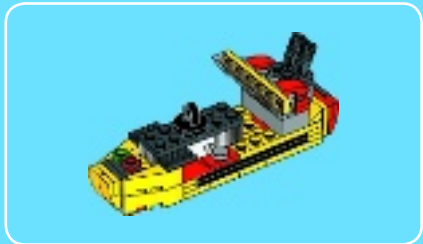

1

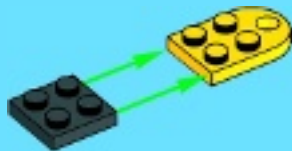

2



2





1x

3



1x

4

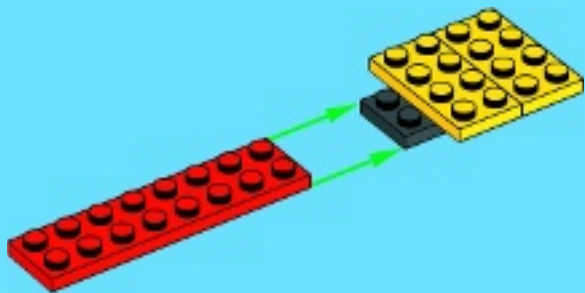



1x

5

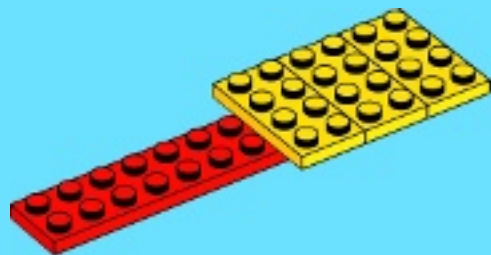

4



2x

6

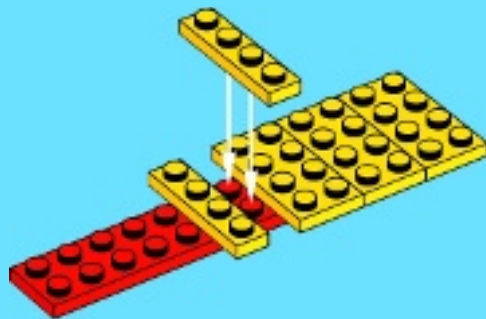



1x



2x

7

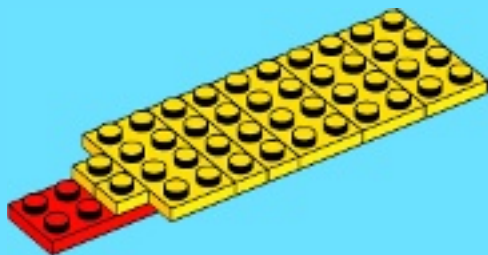

1x



1x



1x

8

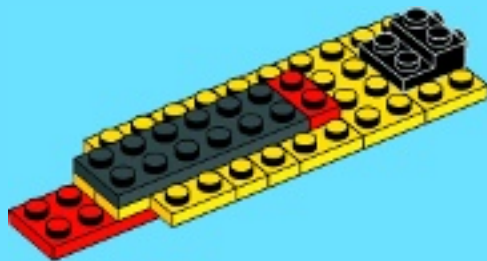



2x



1x

9



6



4x

10



2x

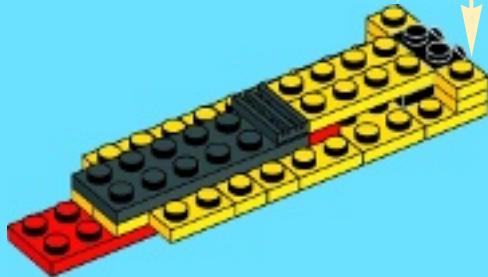



4x

11

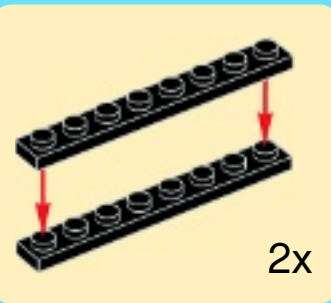

2x

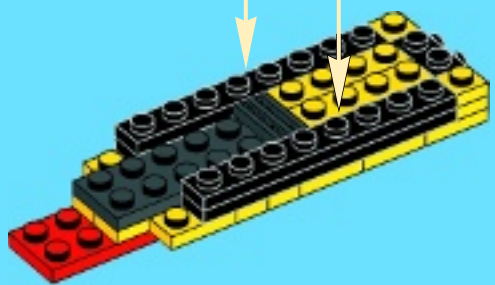



4x

12



2x

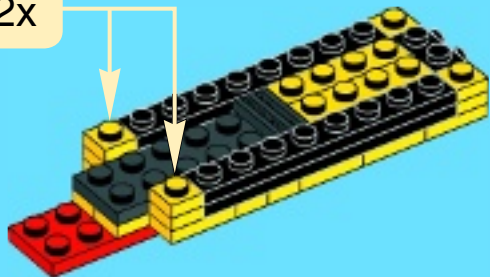

8



1x

13

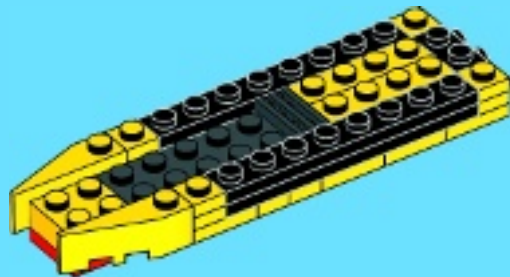



2x



1x

14

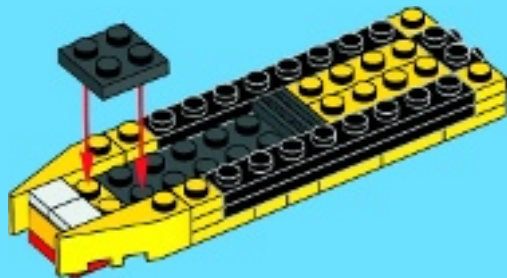

1x



1x



1x

15

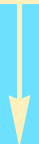
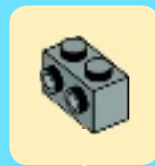



2x

16

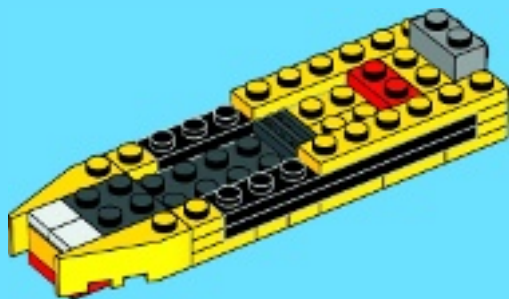

10



2x

17

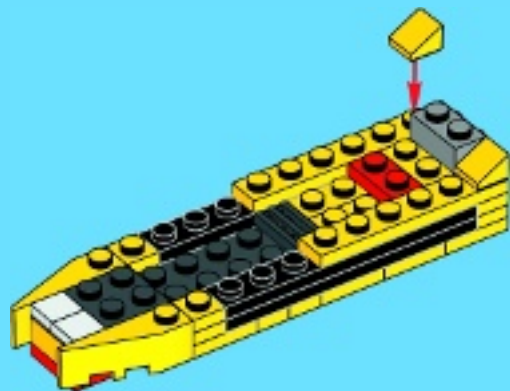

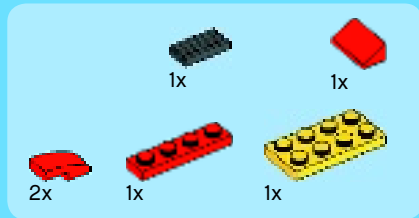

18

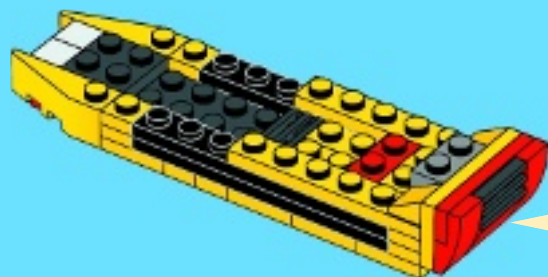



1x



1x

19

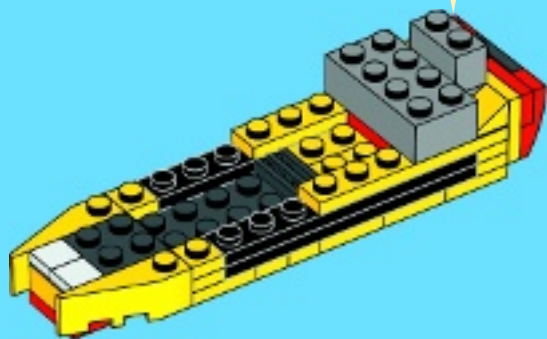
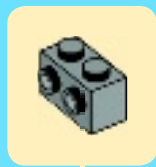

2x

20

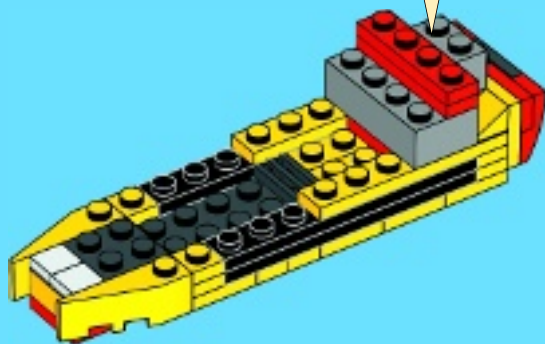
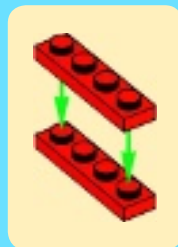



2x

21

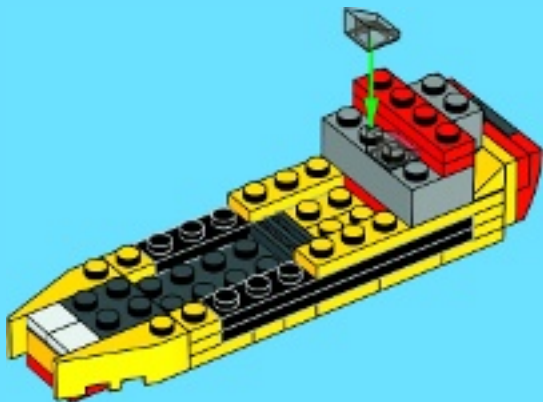

2x

22

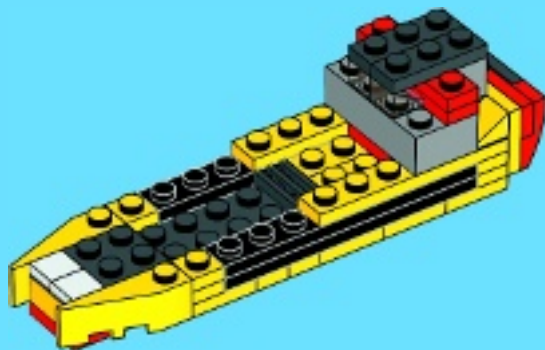



2x



2x

23

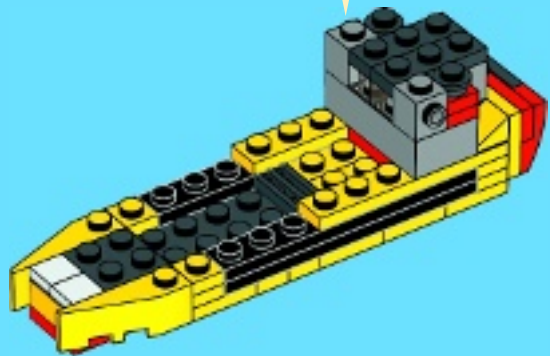

2x



2x

24





2x

25

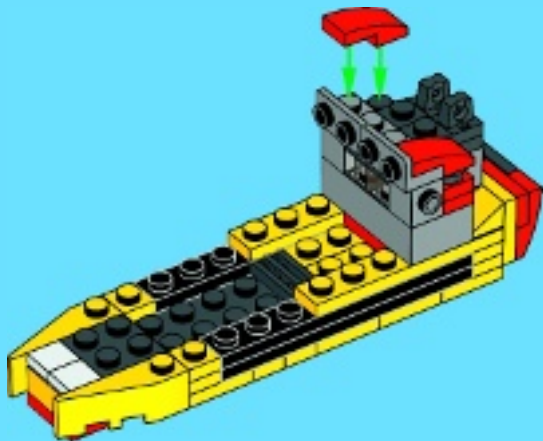

2x

26

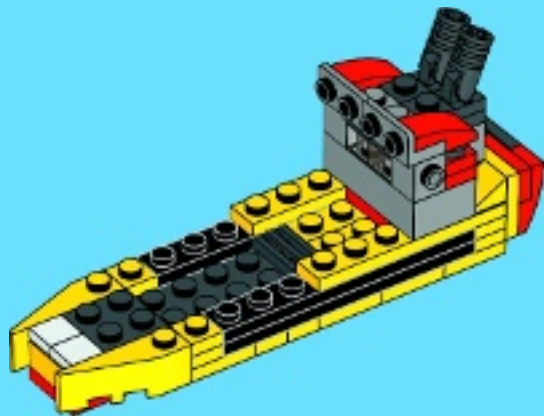



1x



6x

27

1

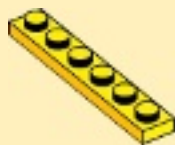

2

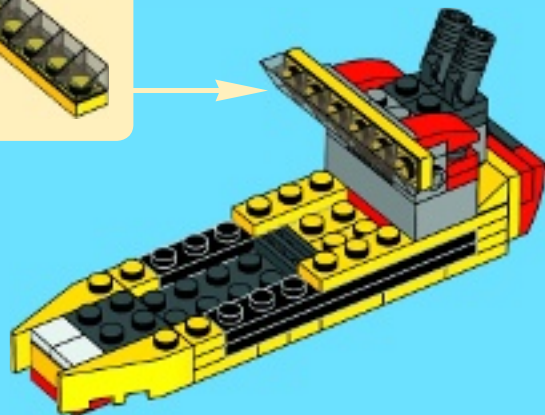
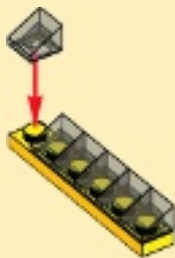



1x

28

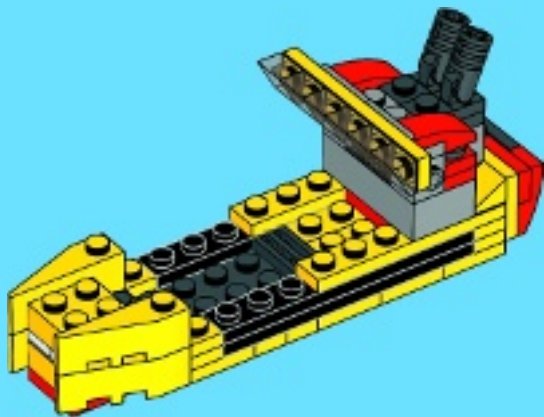

2x



2x

29





1x

30



1x



1x



2x



2x

31





1x



1x



2x

32

1



2



3



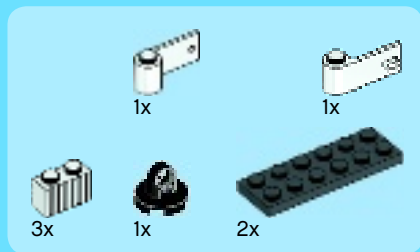

33

1



2

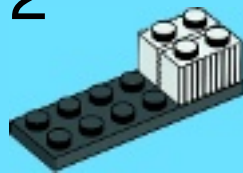

3

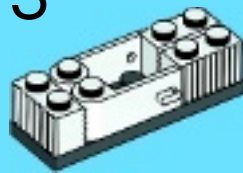

4



5





CREATOR



CREATOR ISLANDS



Apple, the Apple logo, iPad, iPhone and iPod touch are trademarks of Apple Inc., registered in the U.S. and other countries. App Store is a service mark of Apple Inc./Apple, le logo Apple, iPad, iPhone et iPod touch sont des marques de commerce d'Apple Inc., déposées aux Etats-Unis et dans d'autres pays. App Store est une marque de service d'Apple Inc./Apple, el logotipo de Apple, iPad, iPhone e iPod touch son marcas comerciales de Apple Inc. registradas en EE. UU. y otros países. App Store es una marca de servicio de Apple Inc.

Google Play is a trademark of Google Inc./Google Play est une marque de commerce de Google Inc./Google Play es una marca comercial de Google Inc.

LEGO.com/creator





CREATOR

31033

3 IN 1



LEGO.com/creator



CREATOR

LEGO and the LEGO logo are trademarks of the/son des marques de commerce du/son marcas registradas de LEGO Group. ©2015 The LEGO Group. 6112303 / 6112308

31029



31027



31033



31033



31029



31027



LEGO.com/creator