

ELVES

41075





LEGO.com/brickseparator



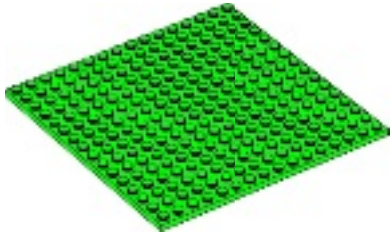

+



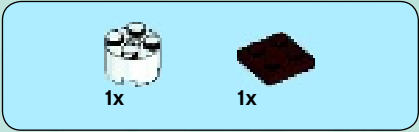

1



2



3

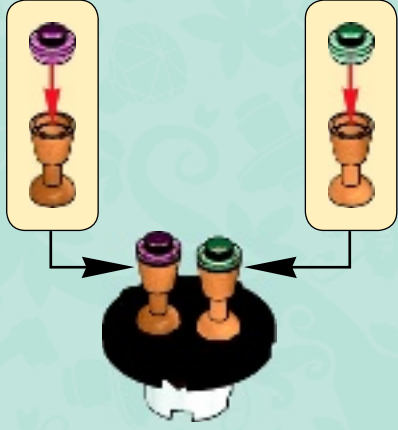

4

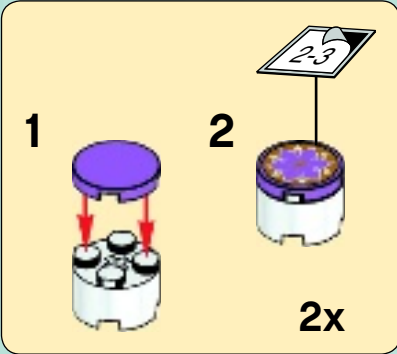

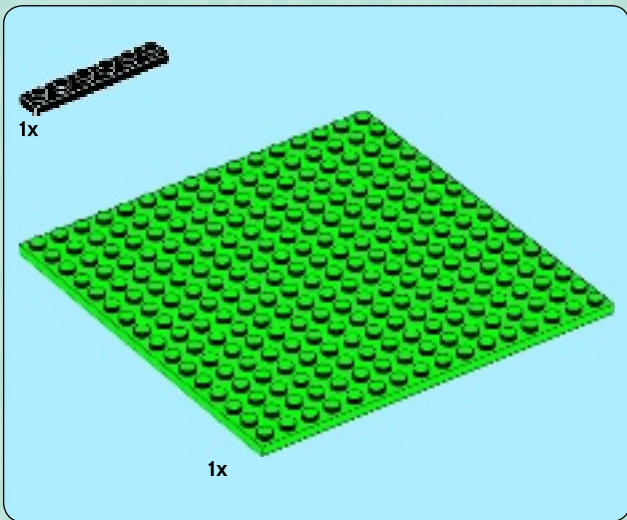

1

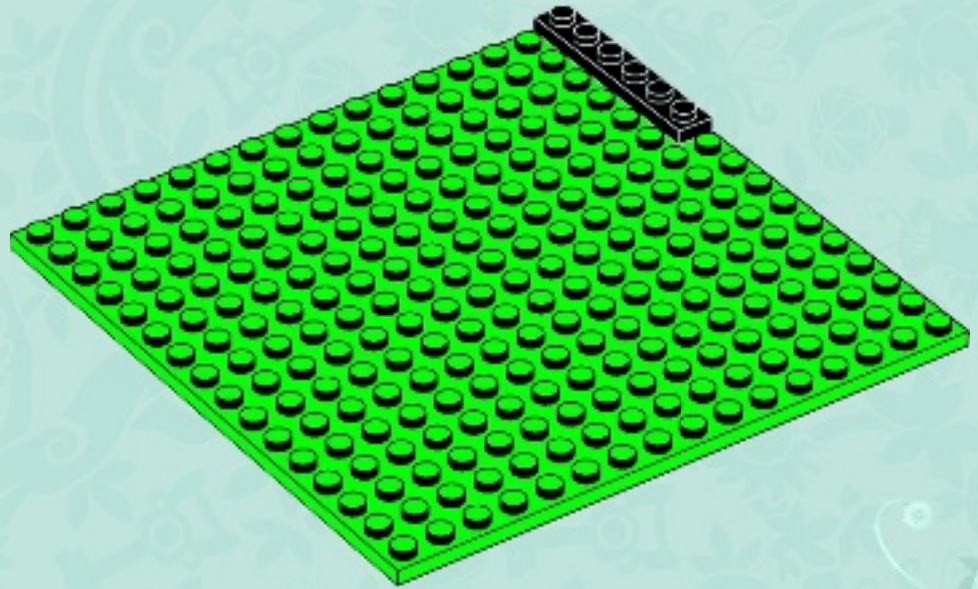

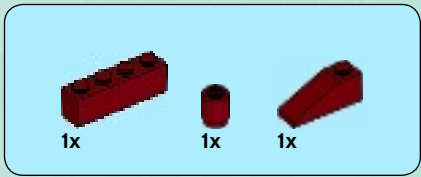

2

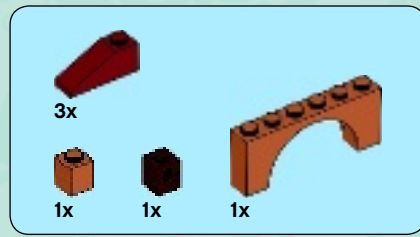
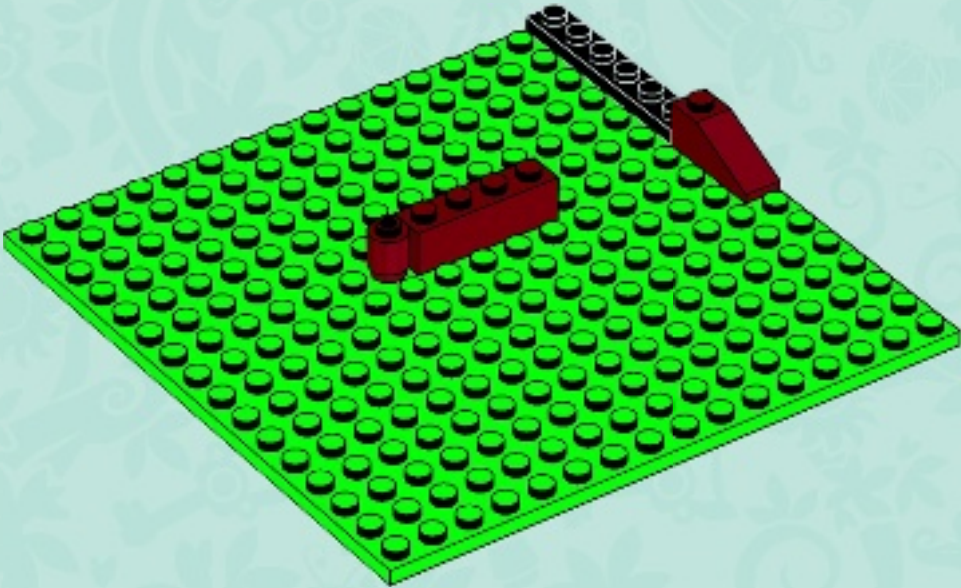

3

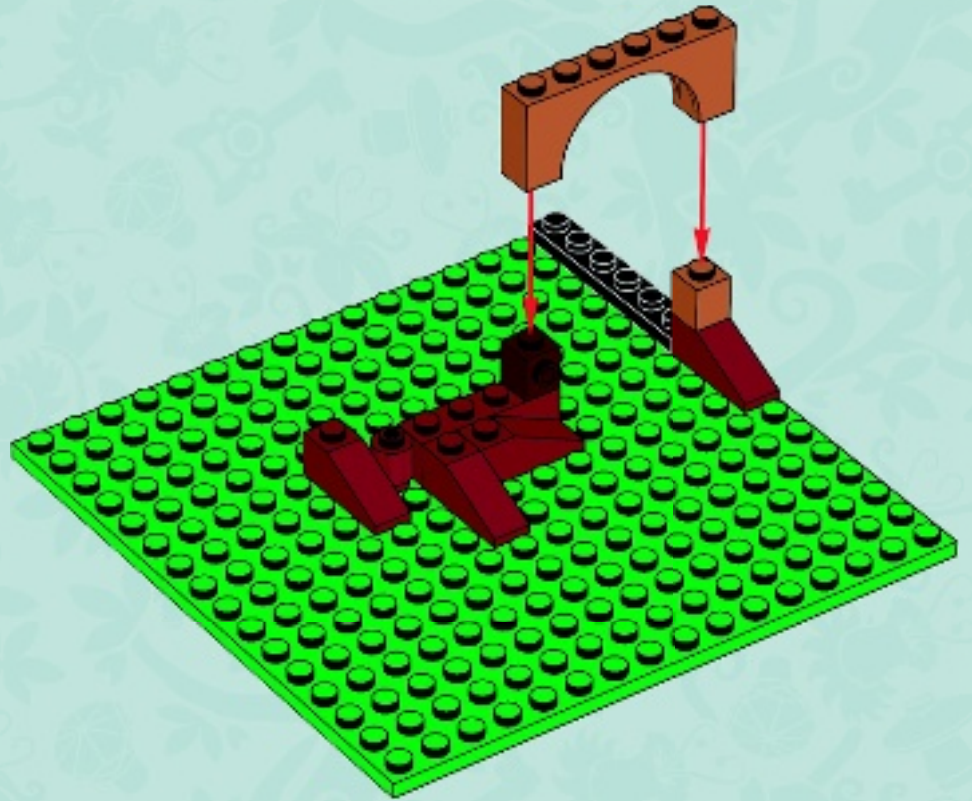

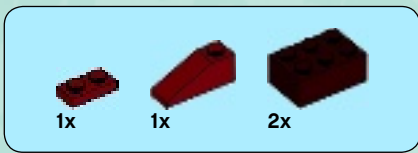

4

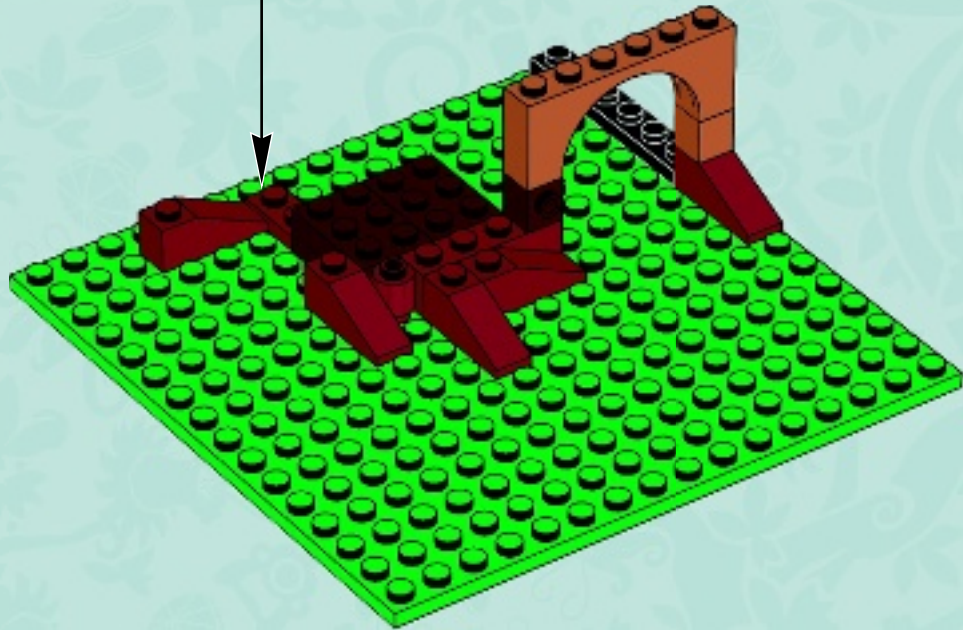

5

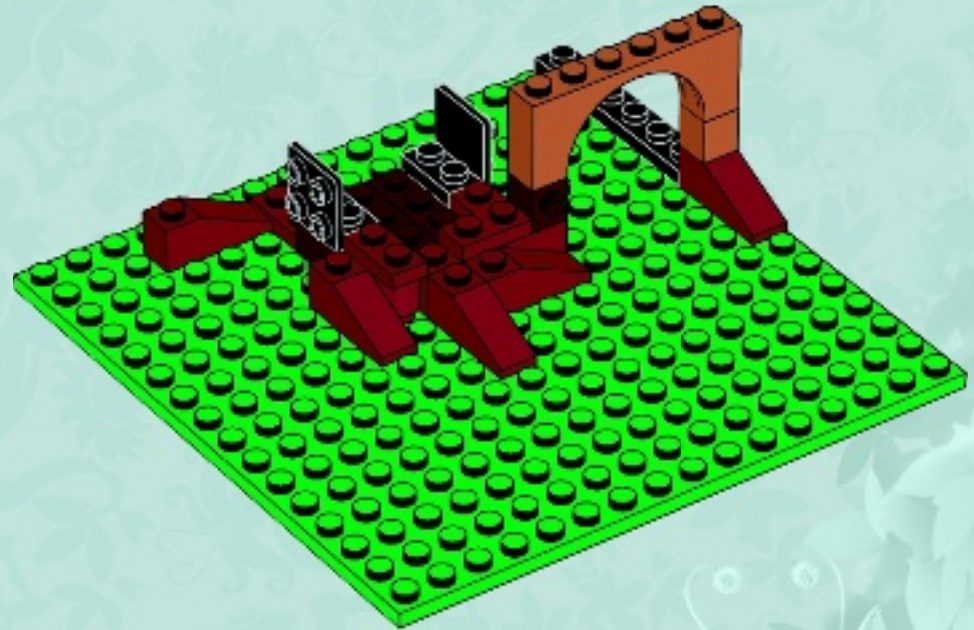

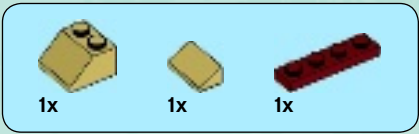

6

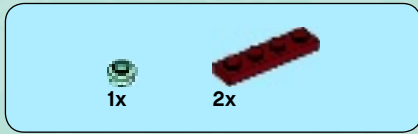
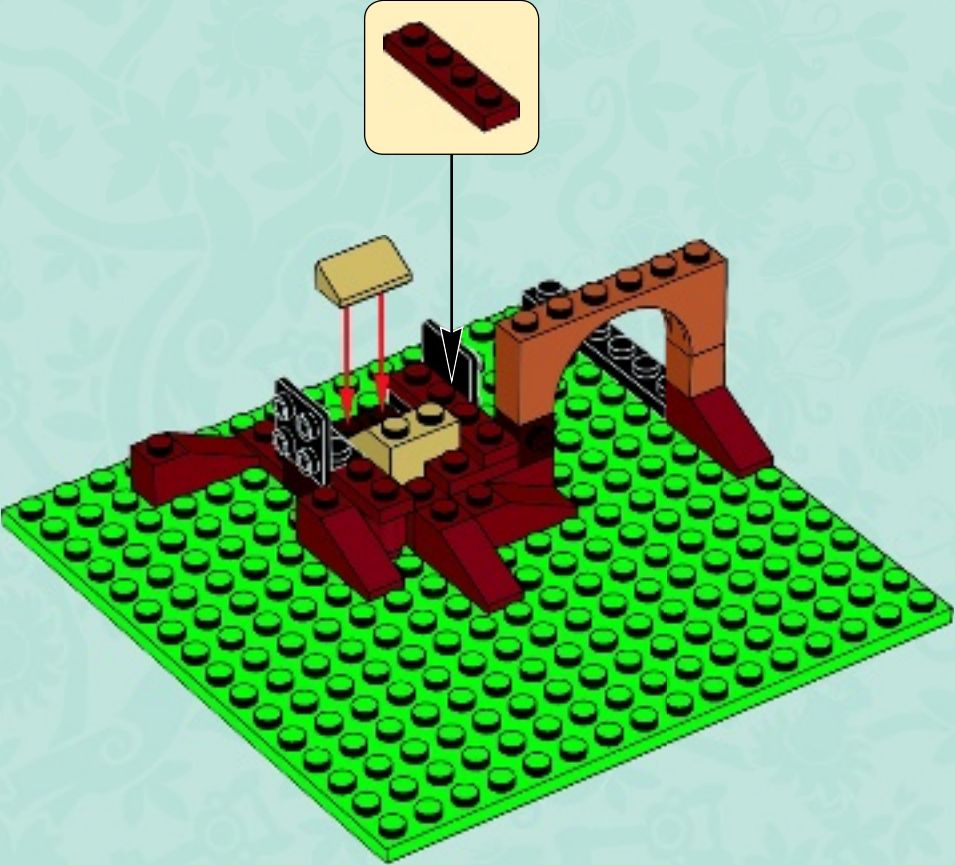

7

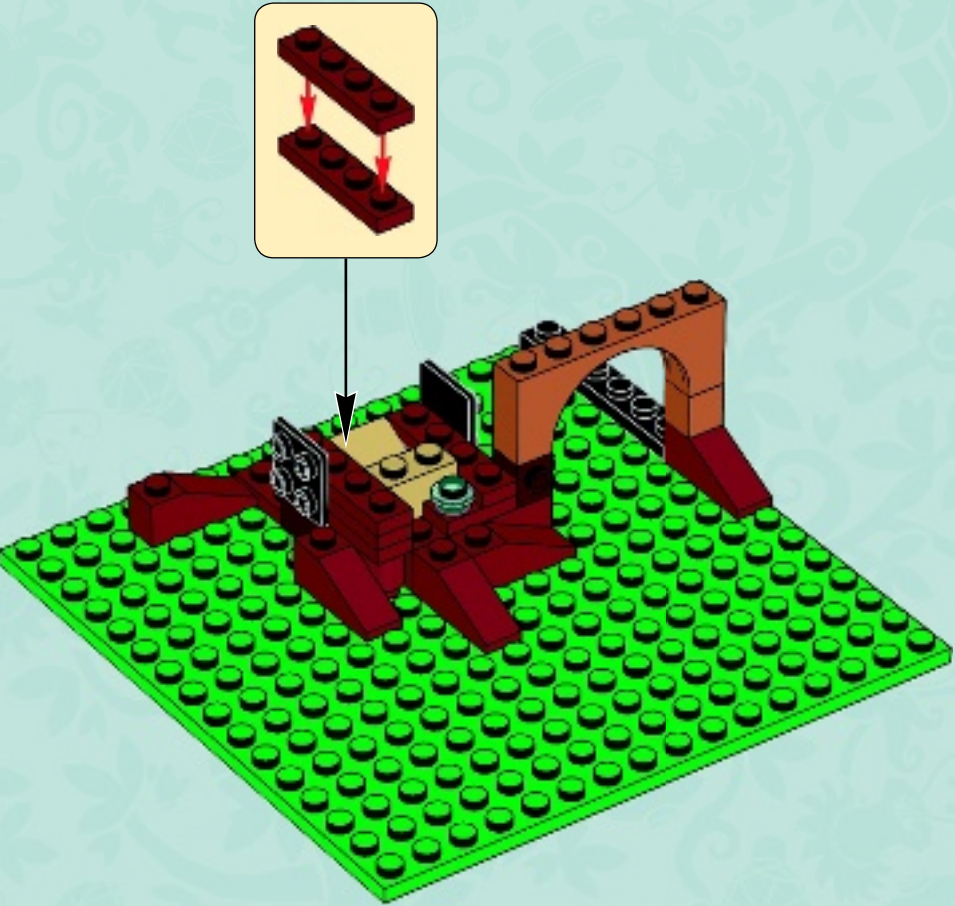

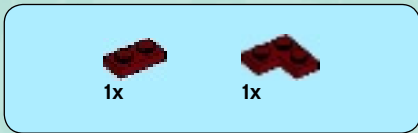

8

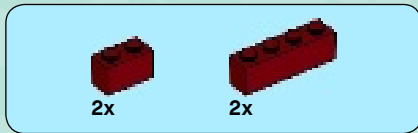
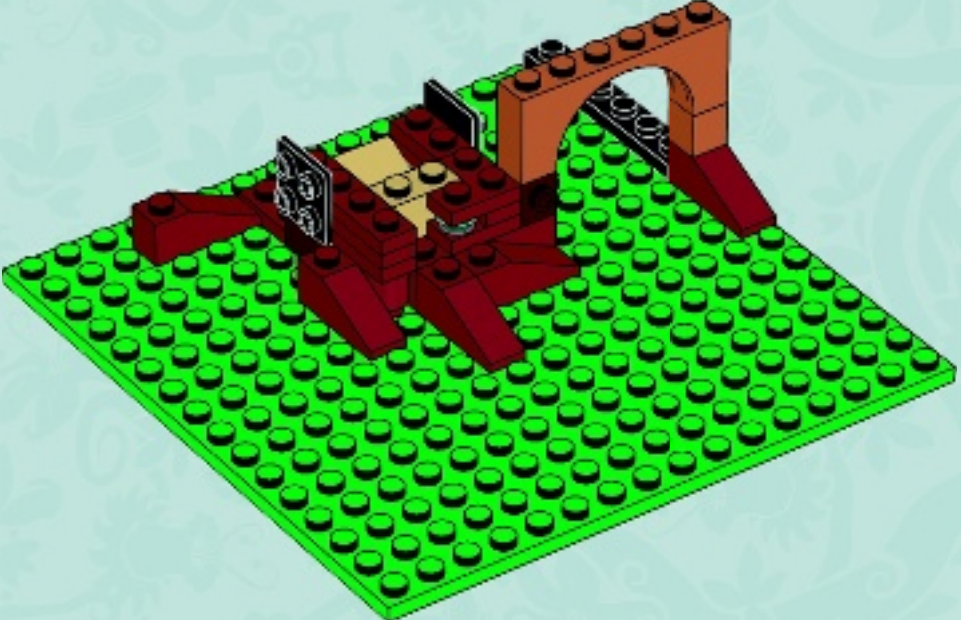

9

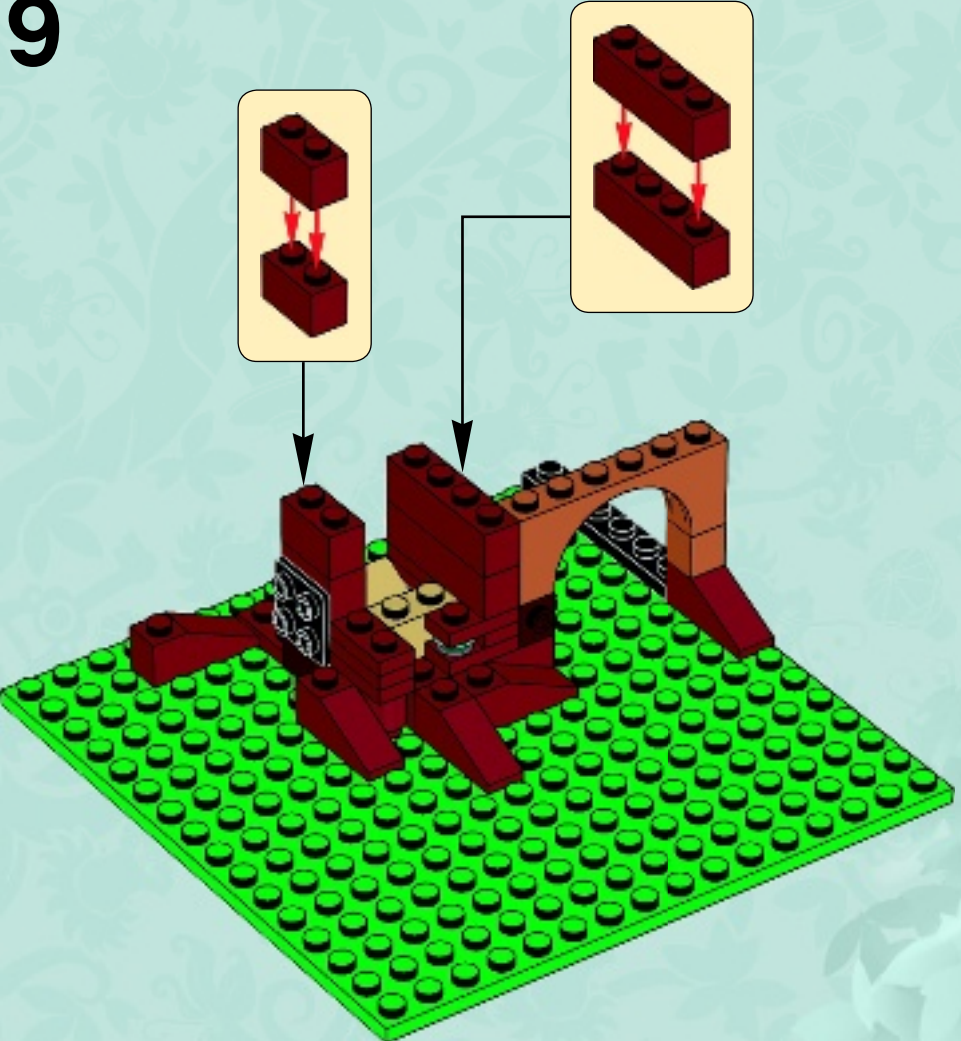

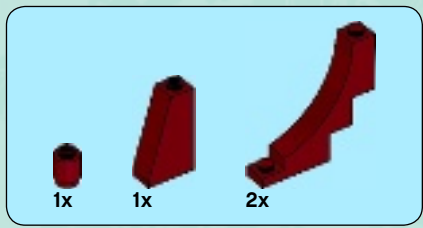

10

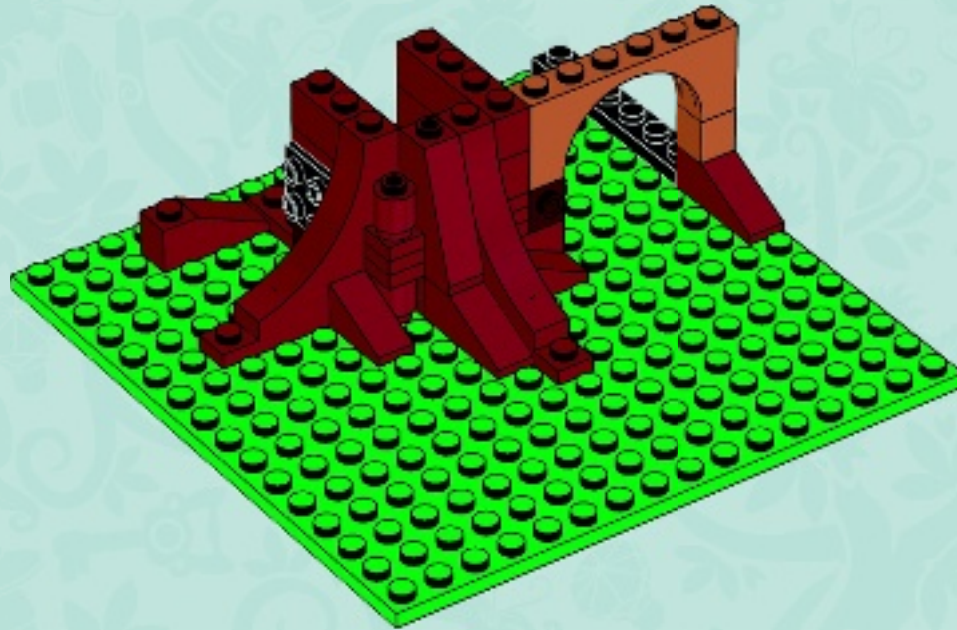



11

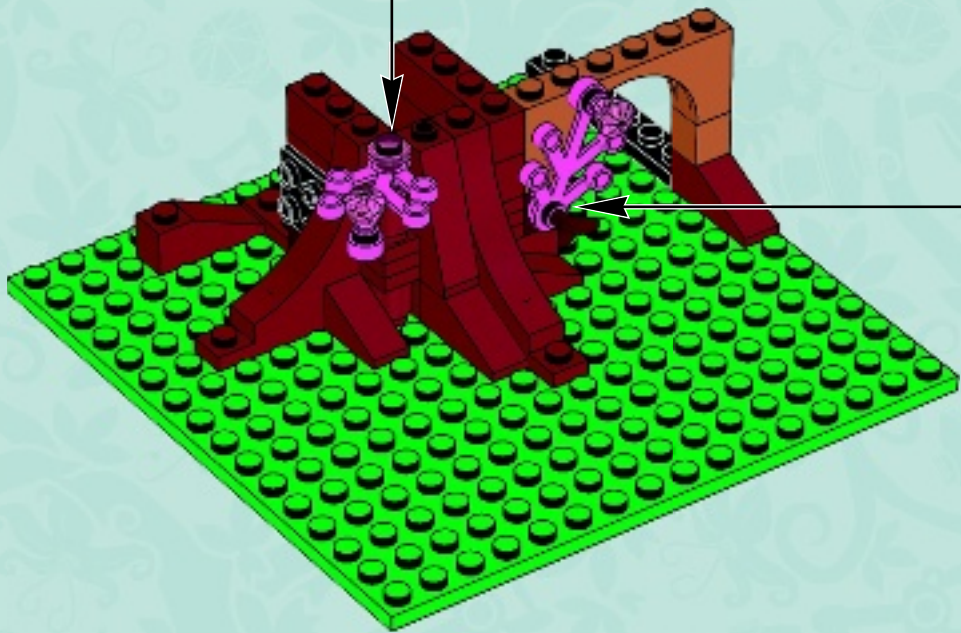
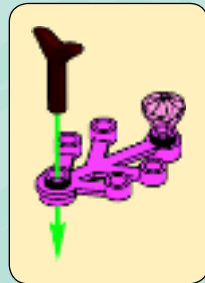
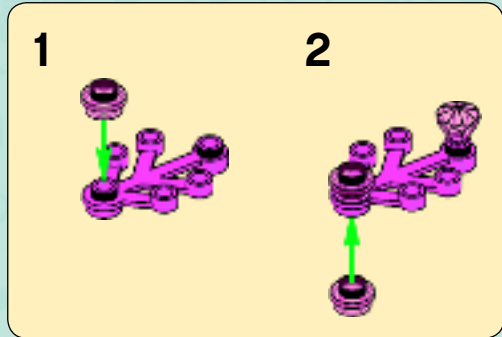

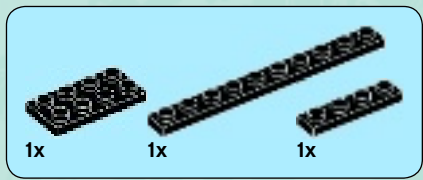

12



13

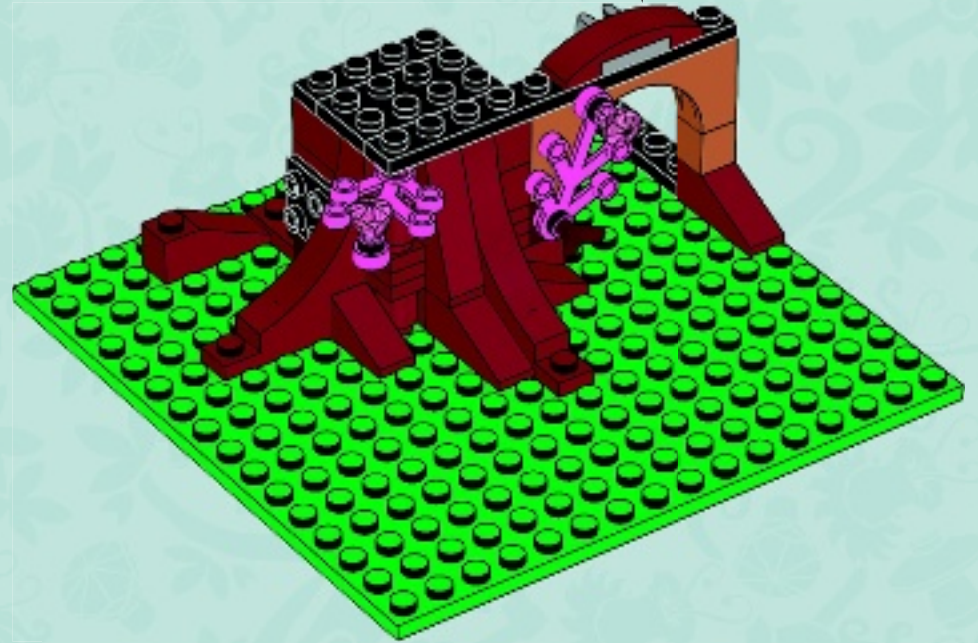
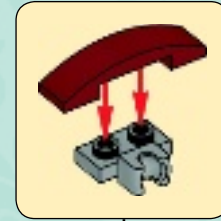

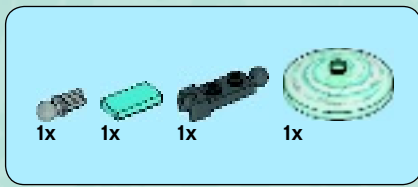

14

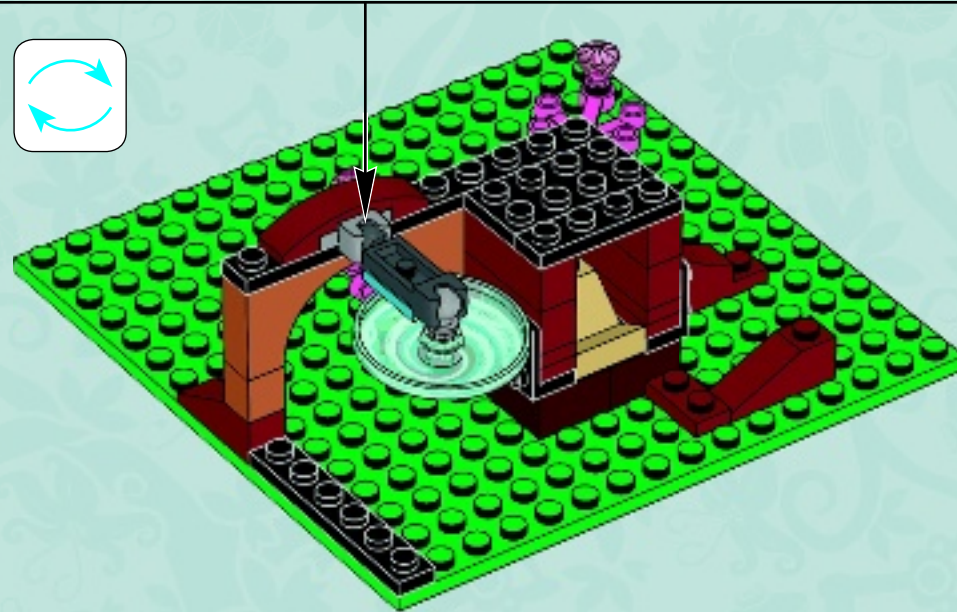
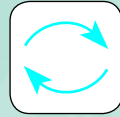
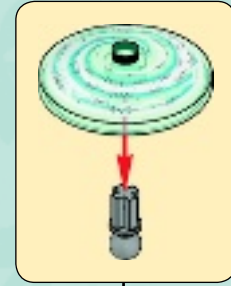
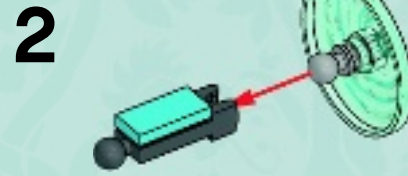
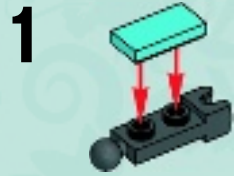

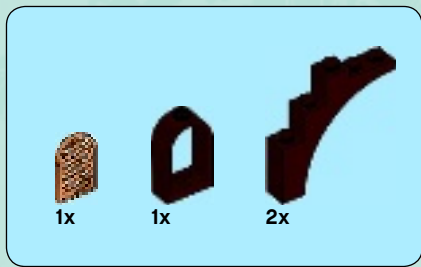

15

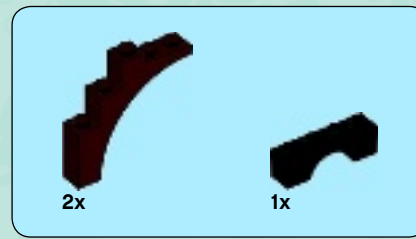
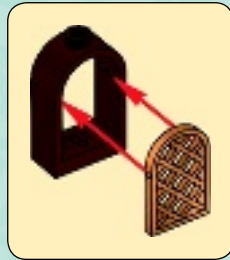

16

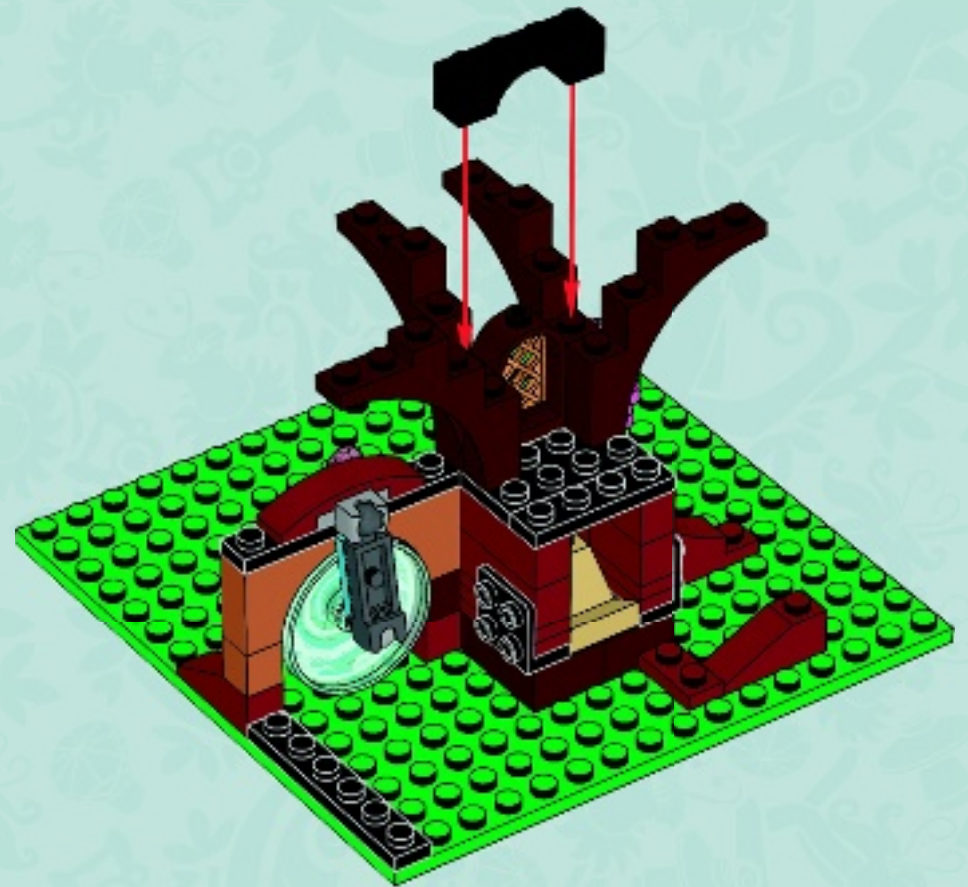

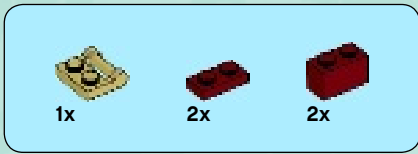

17

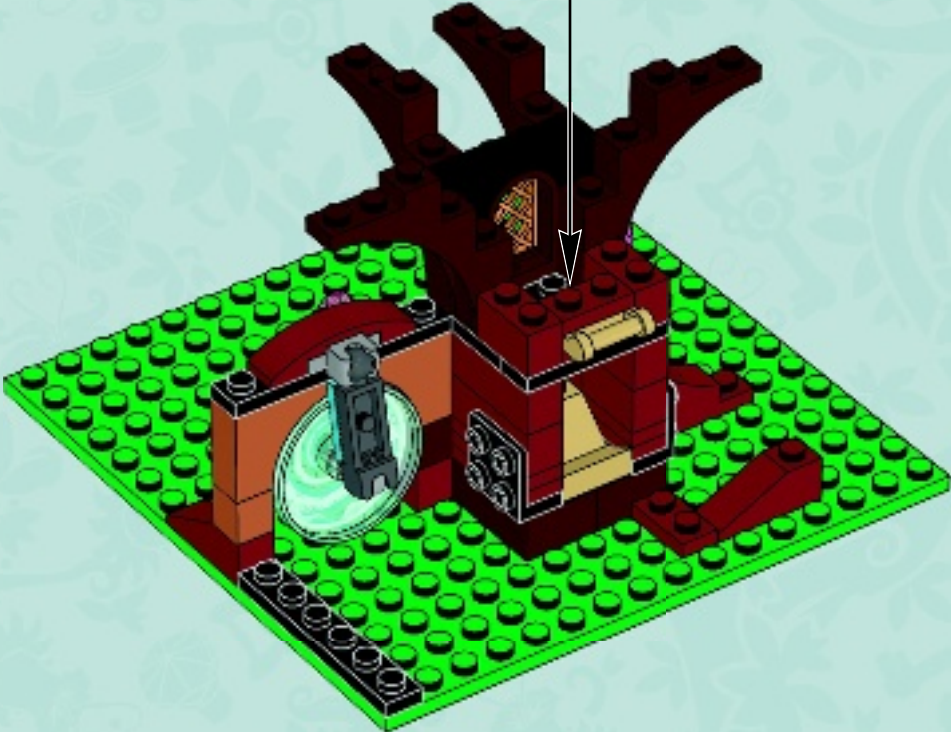
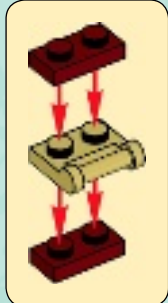

18

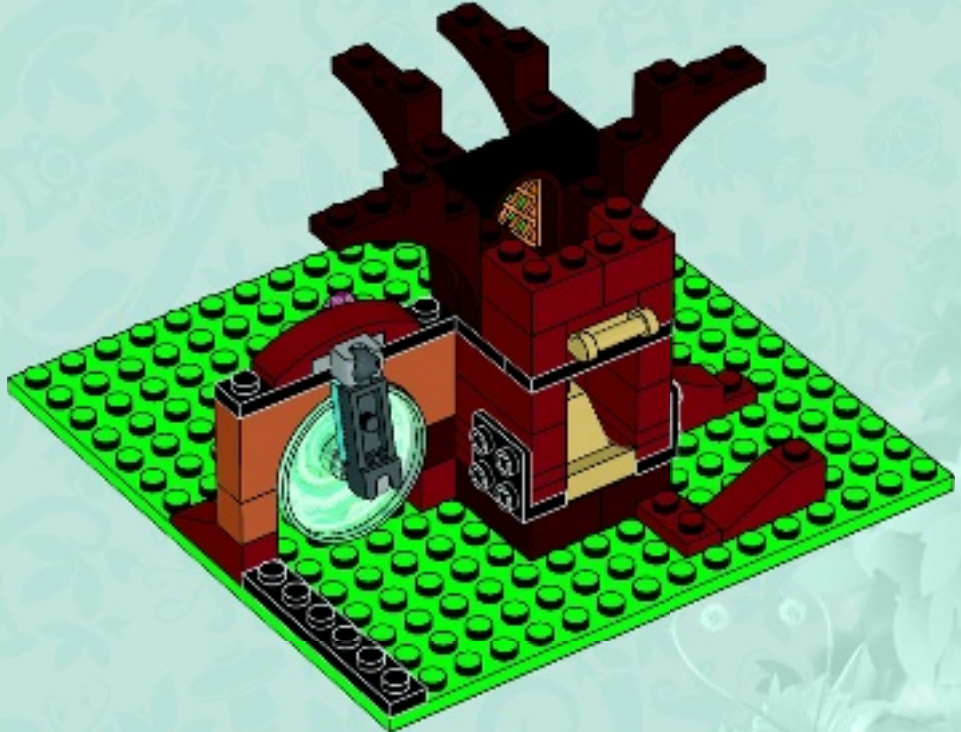

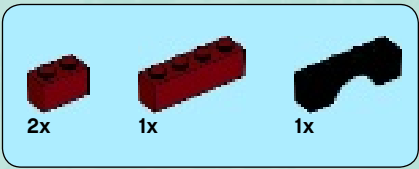

19

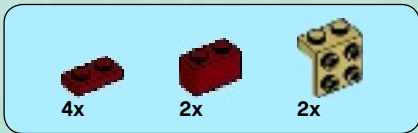
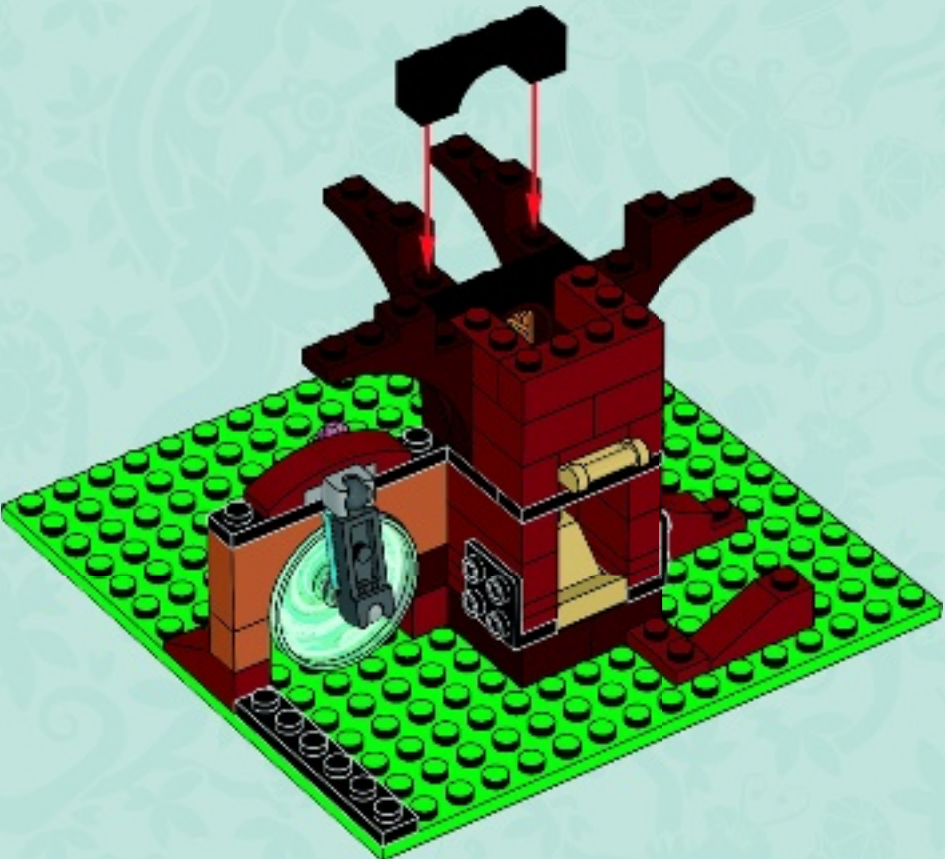

20

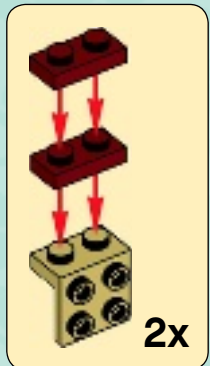

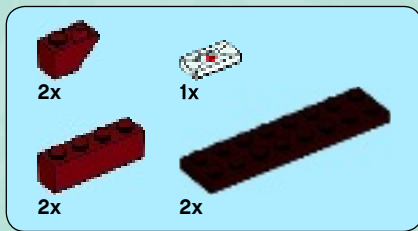

21

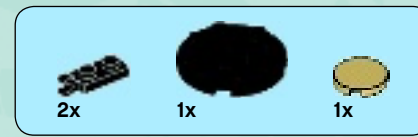

22

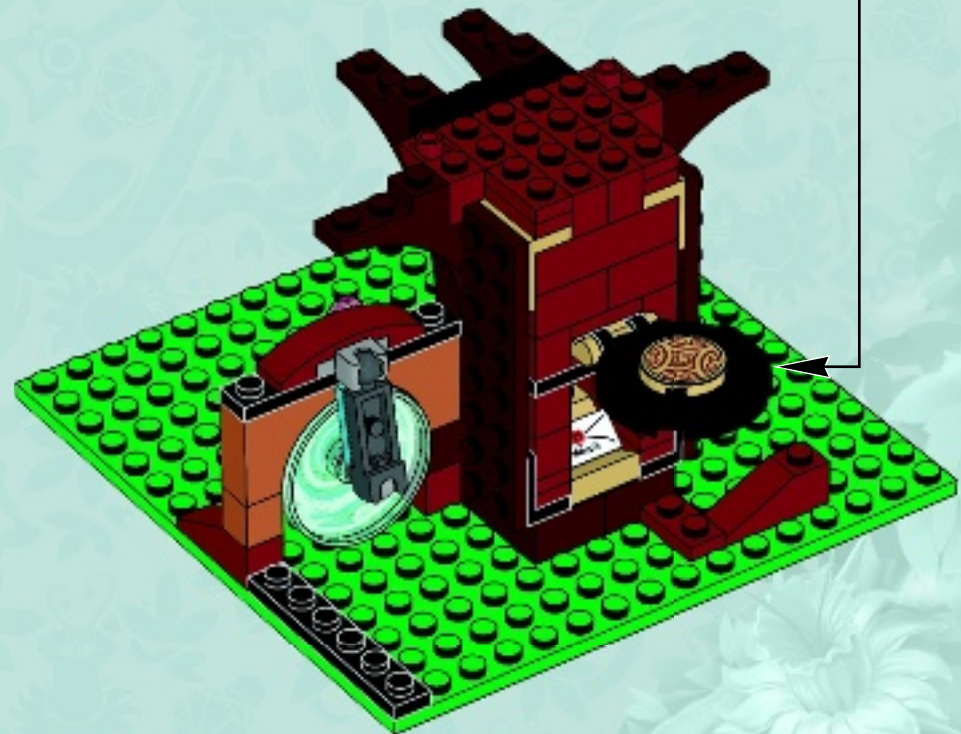
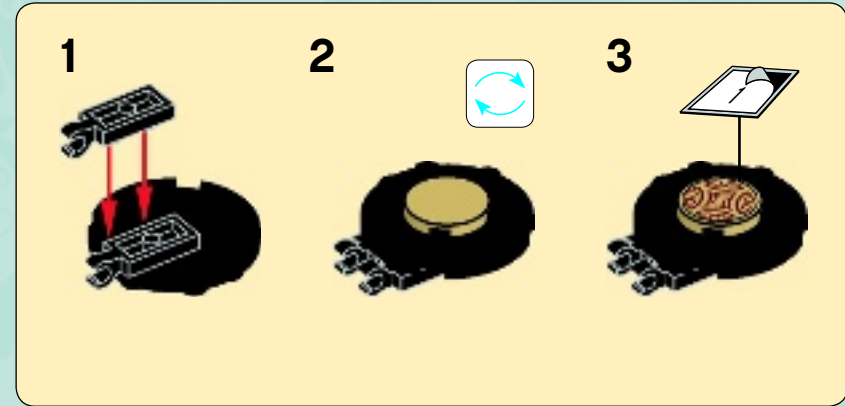

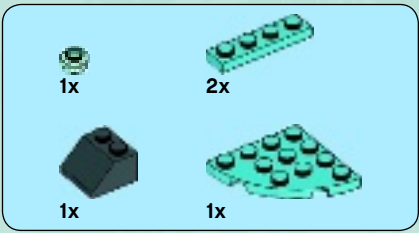

23



24





25

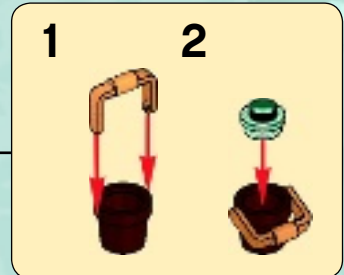
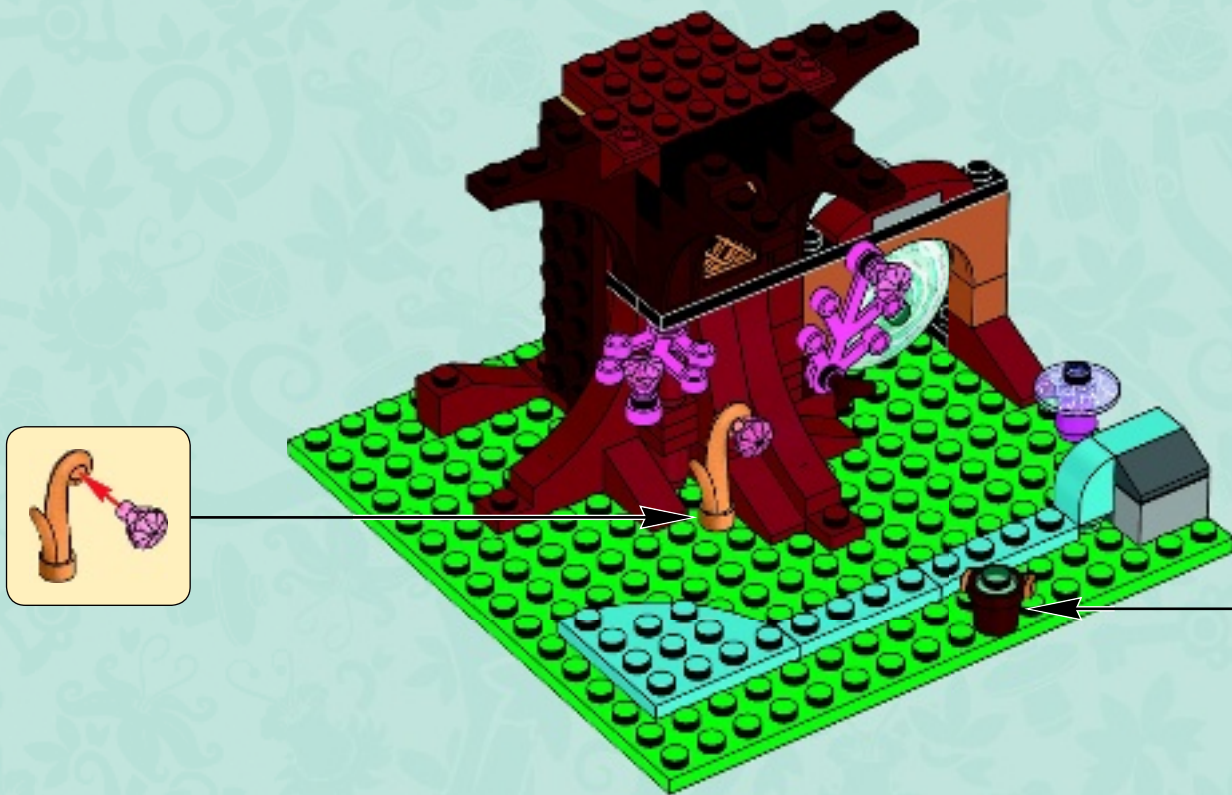

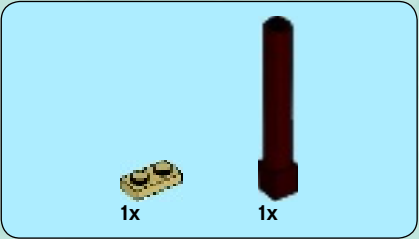

26

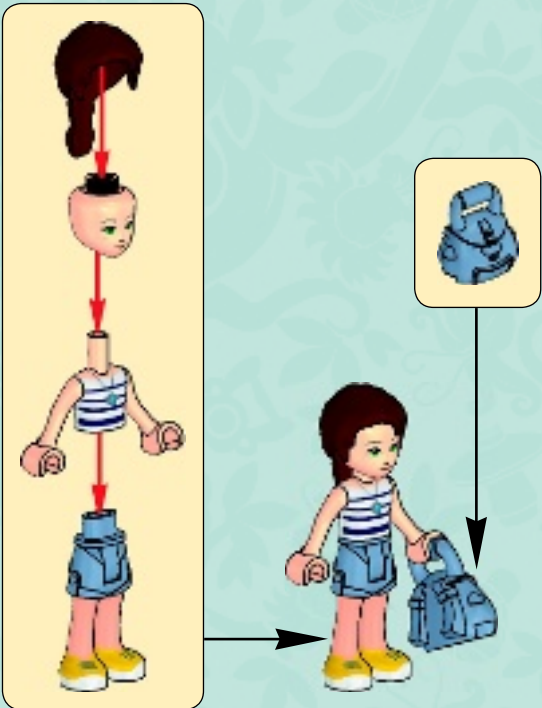

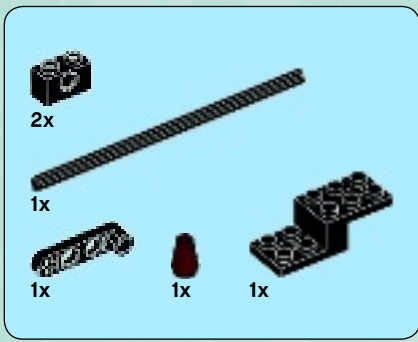

27

1



2



3

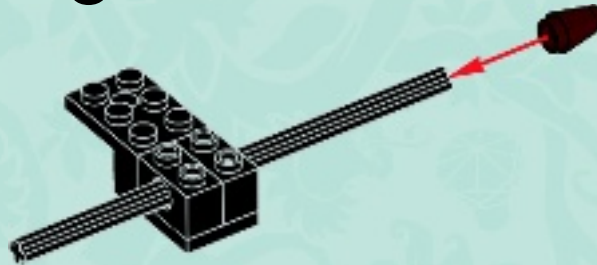

4

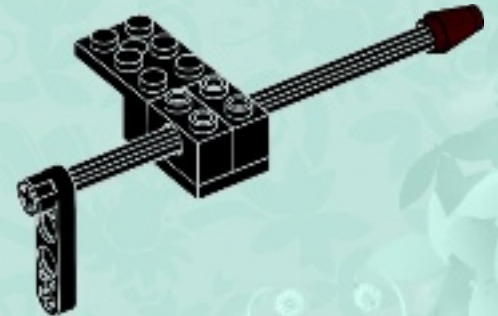

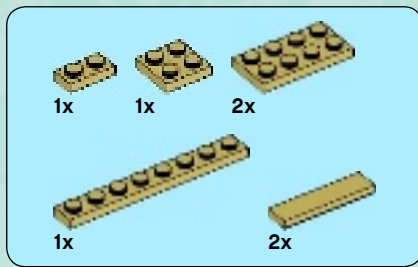

28

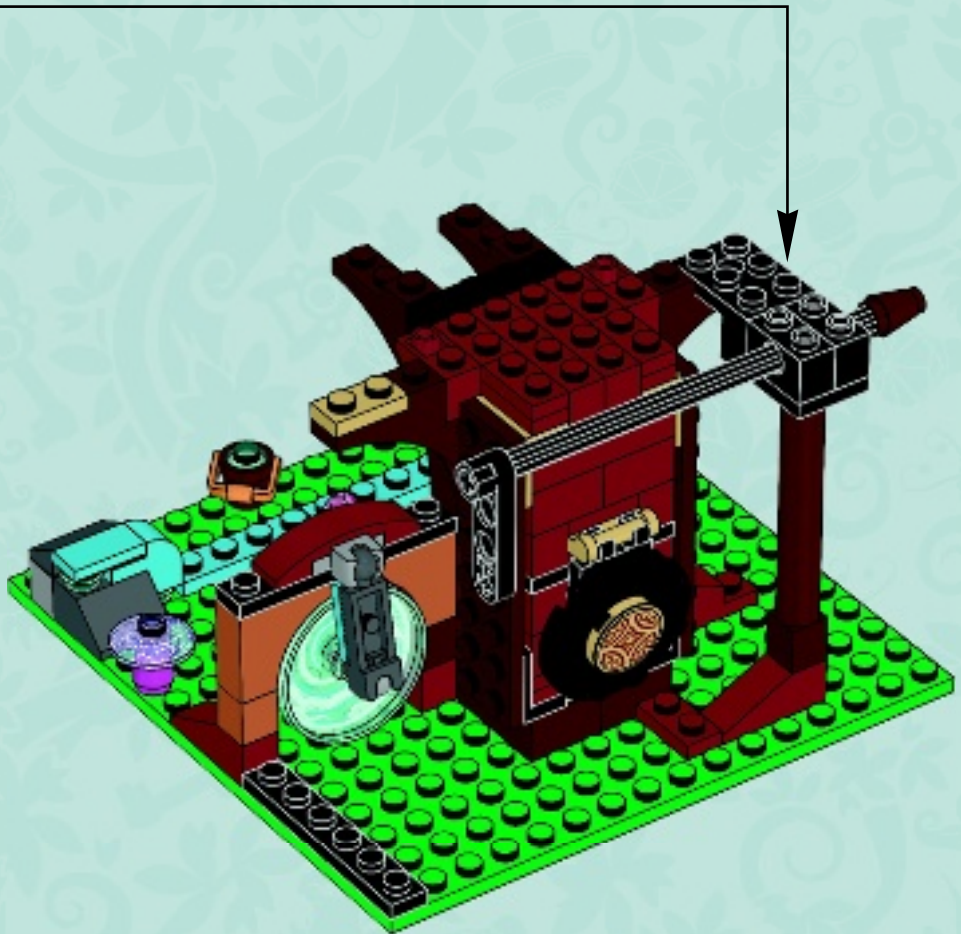



29

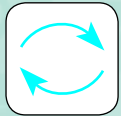
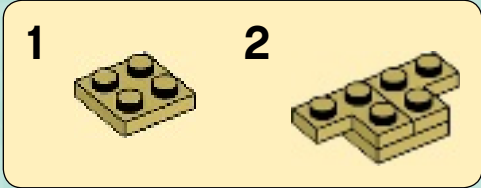

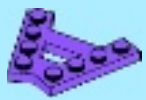

2x

30

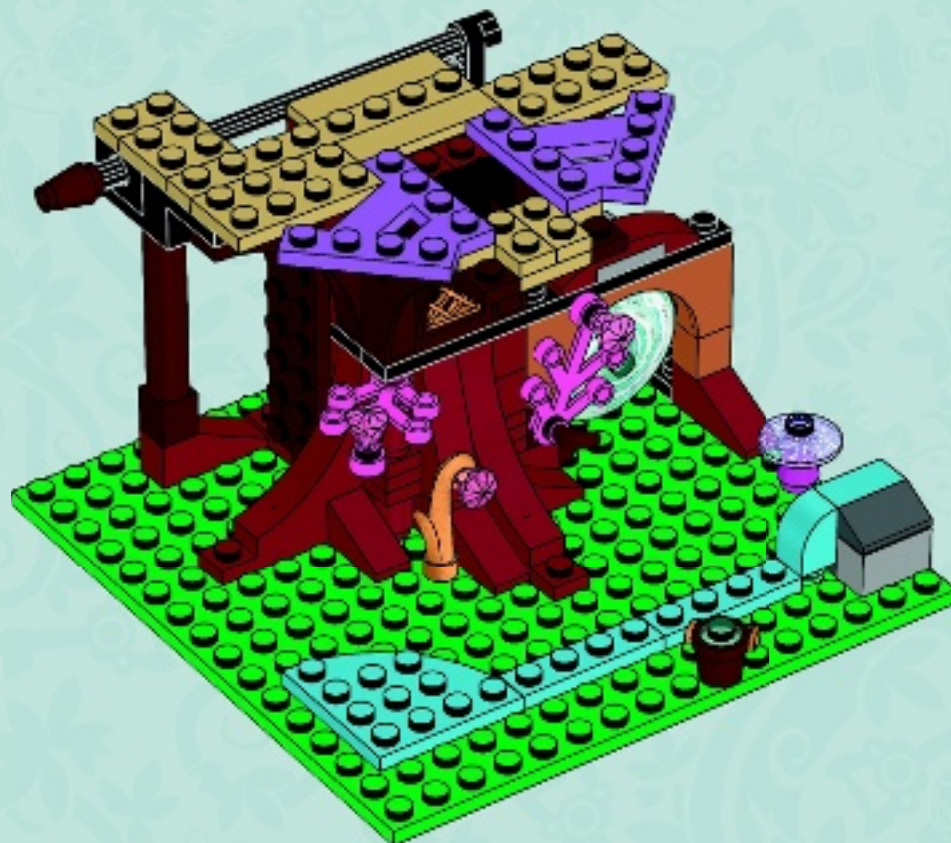

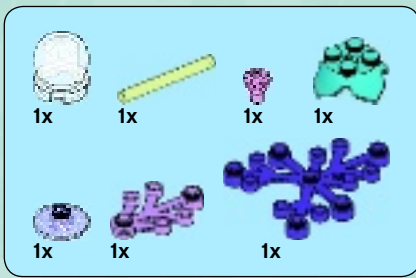

31

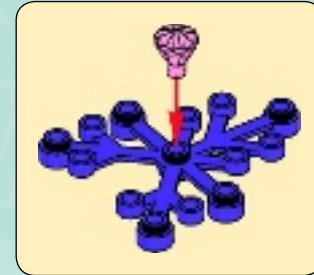
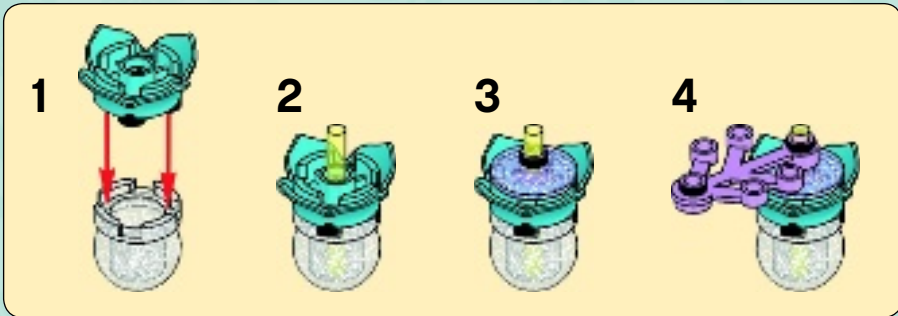

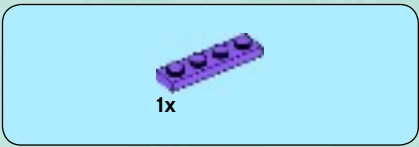

32



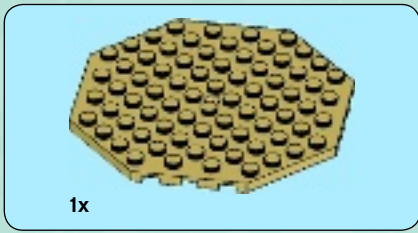

33



34



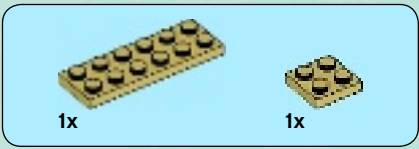

35





36

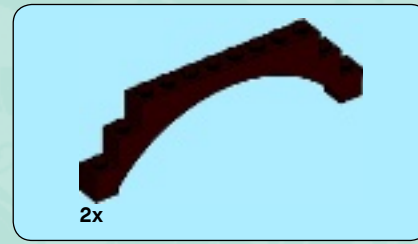
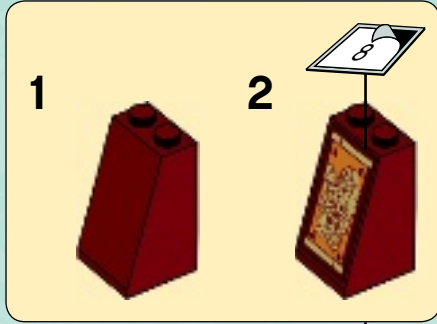

37





38





3x

39



2x



2x

40



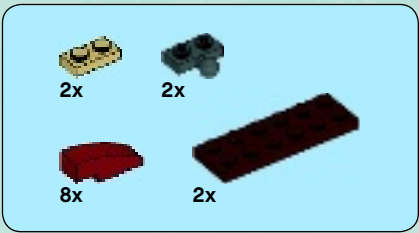

41

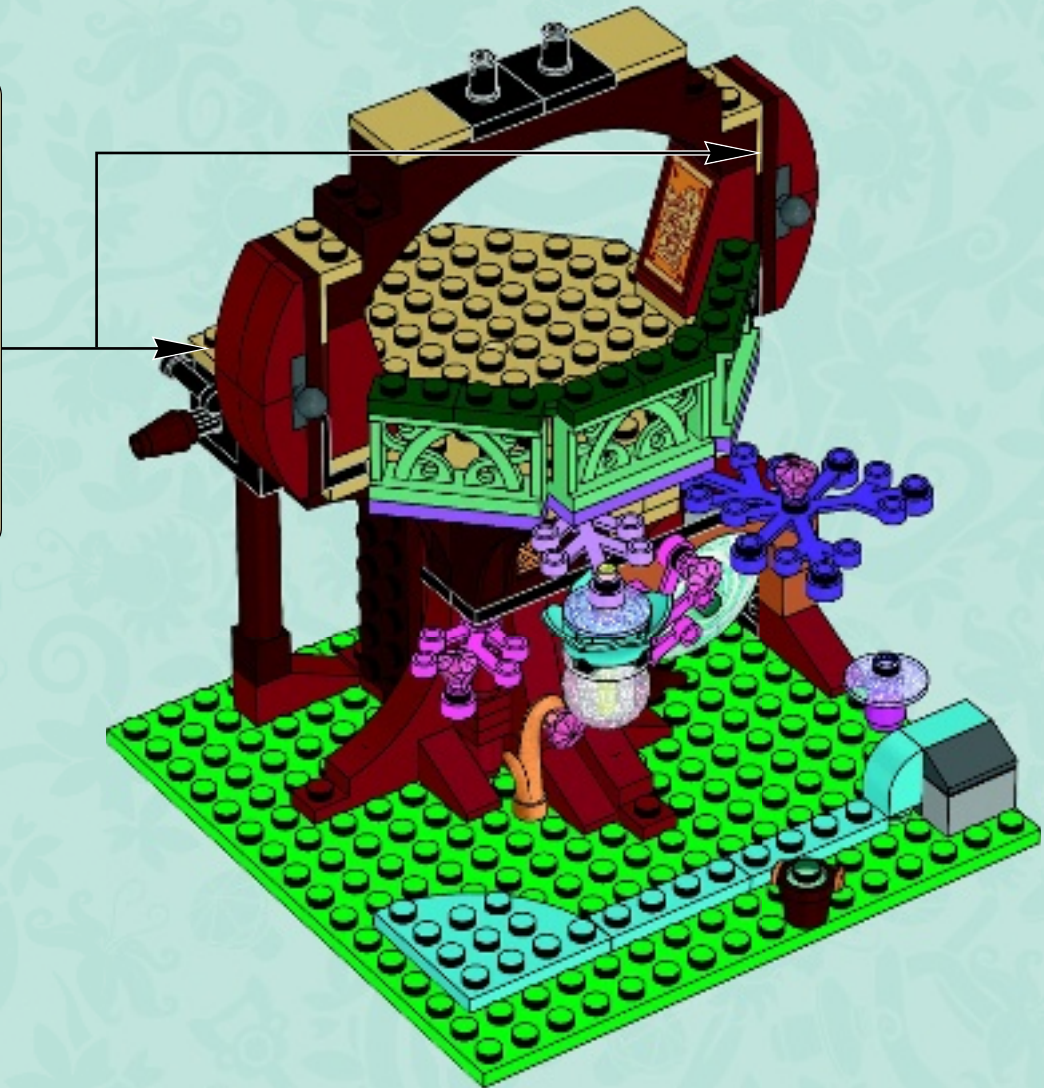
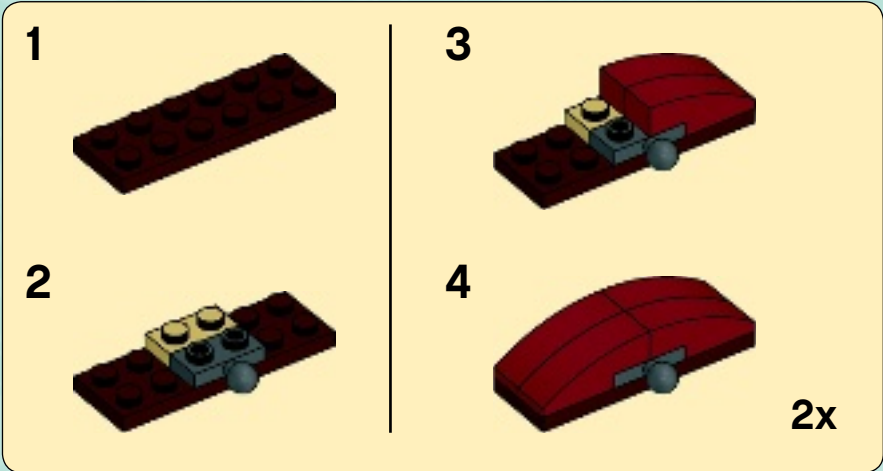



42

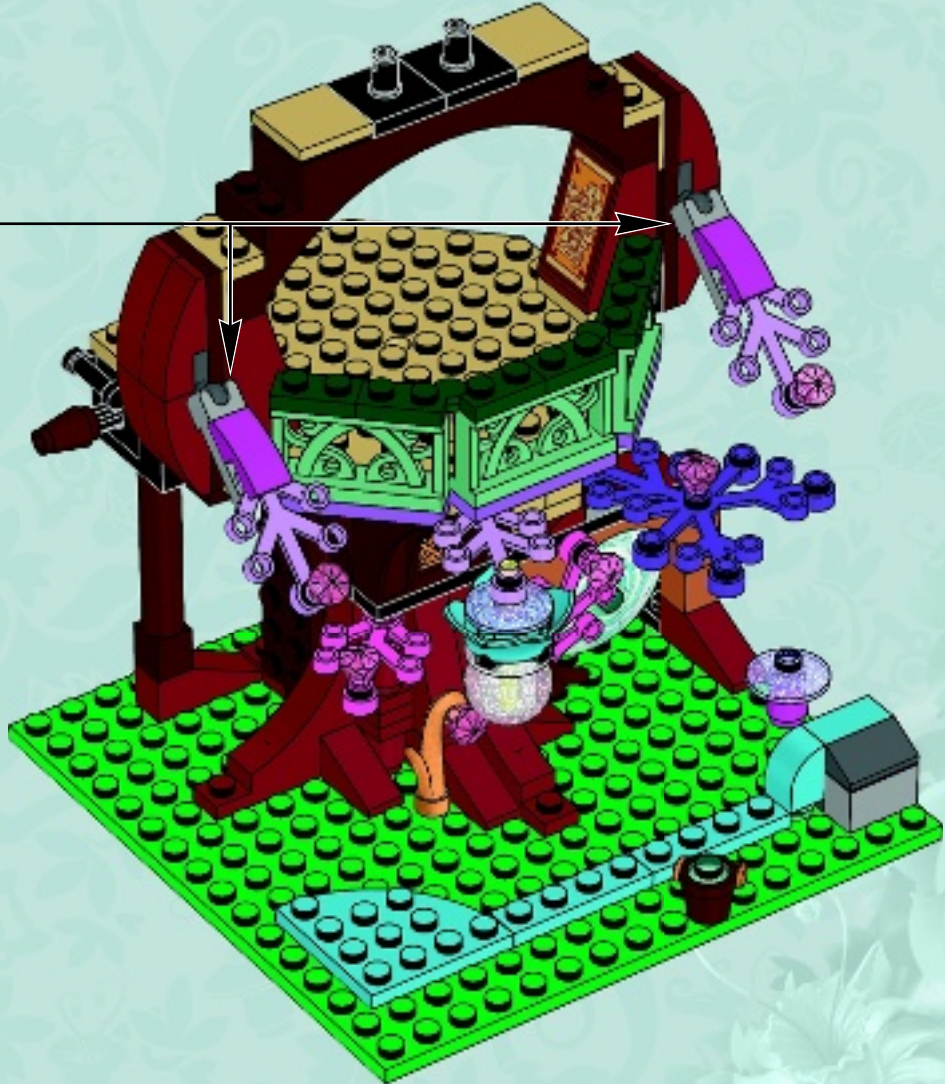
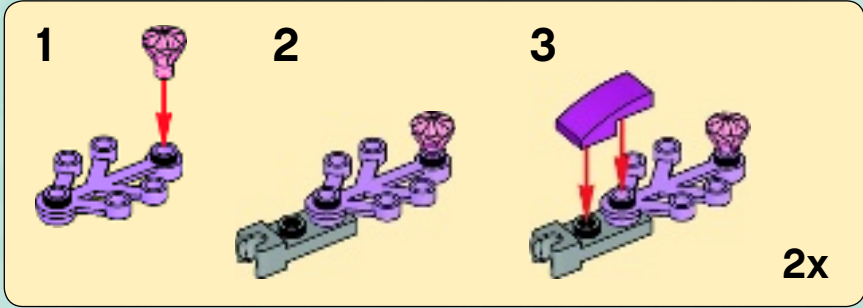

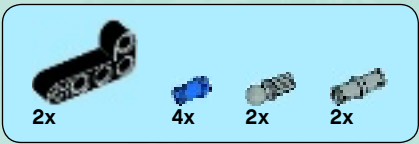

43

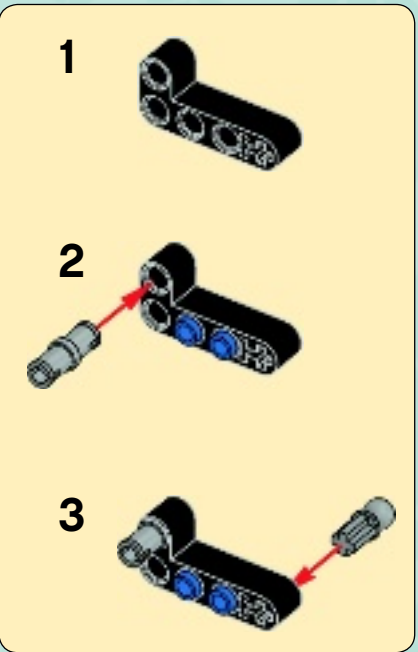
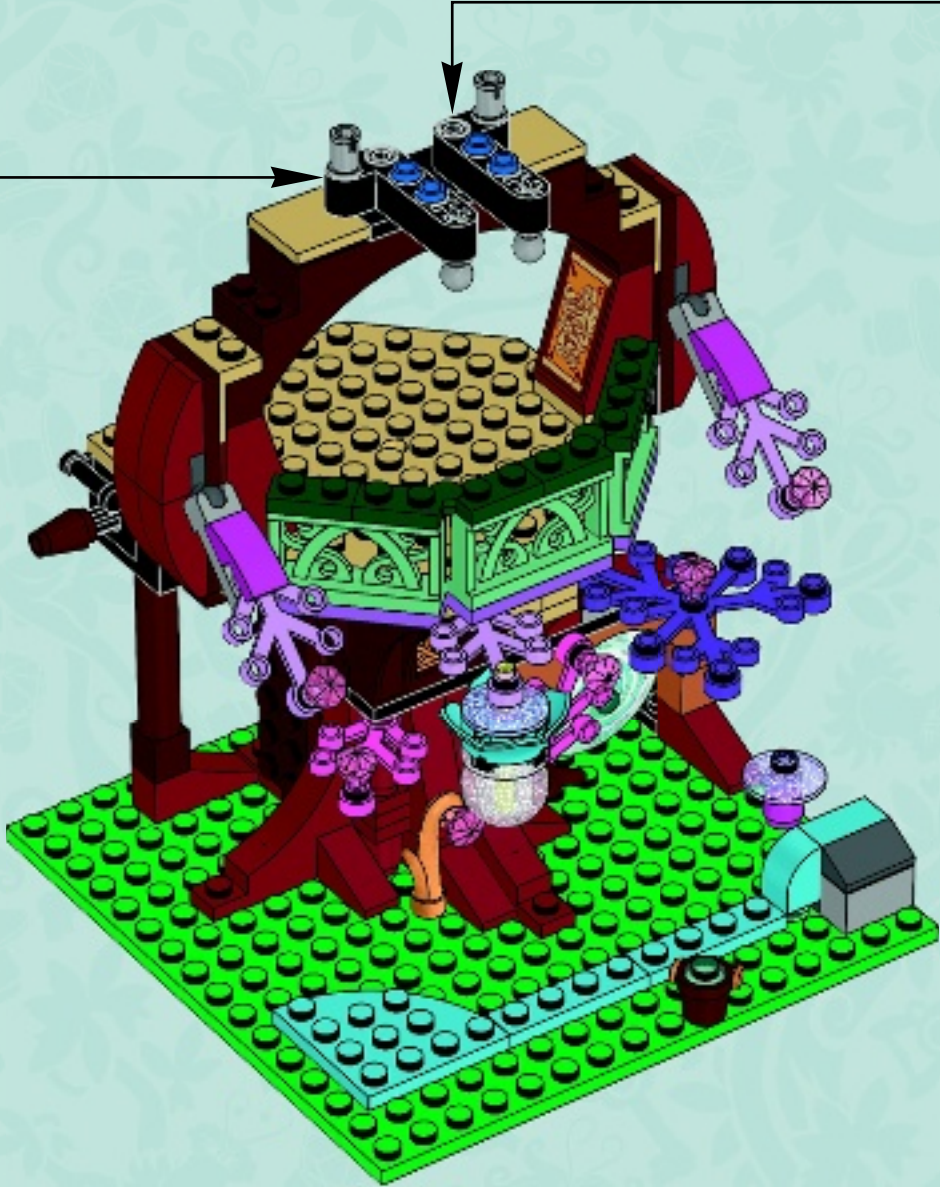
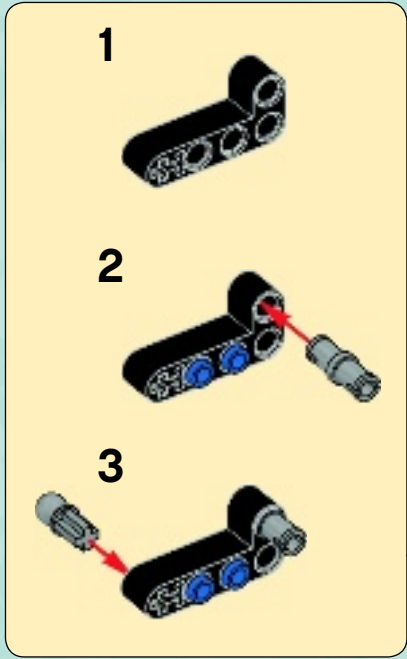

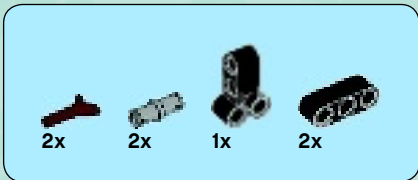

44

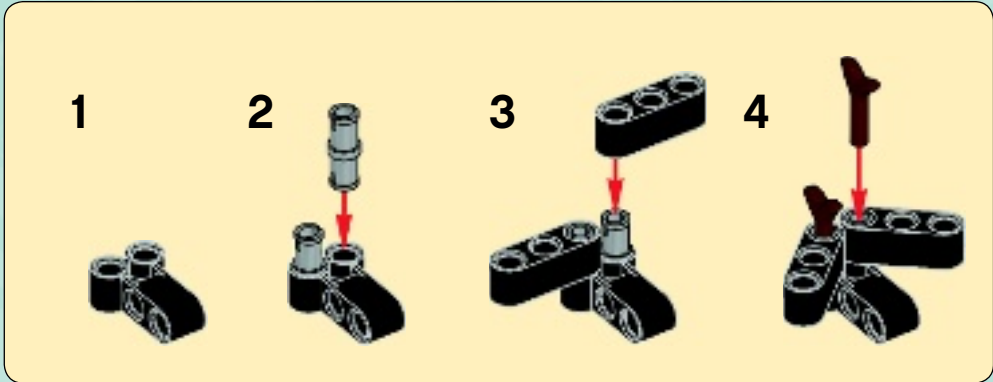

2x

2x

2x

45

1

2



1

2

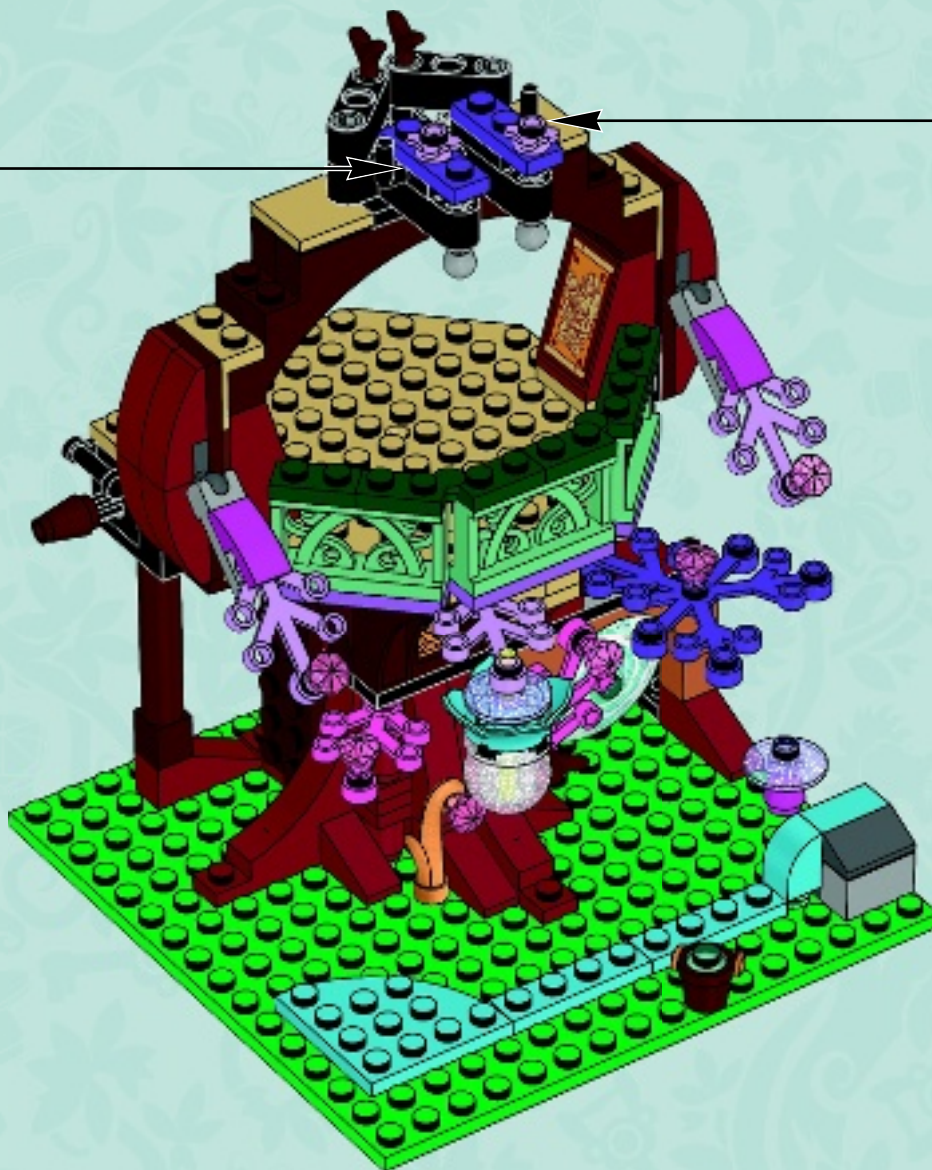



46

1



2



3



4

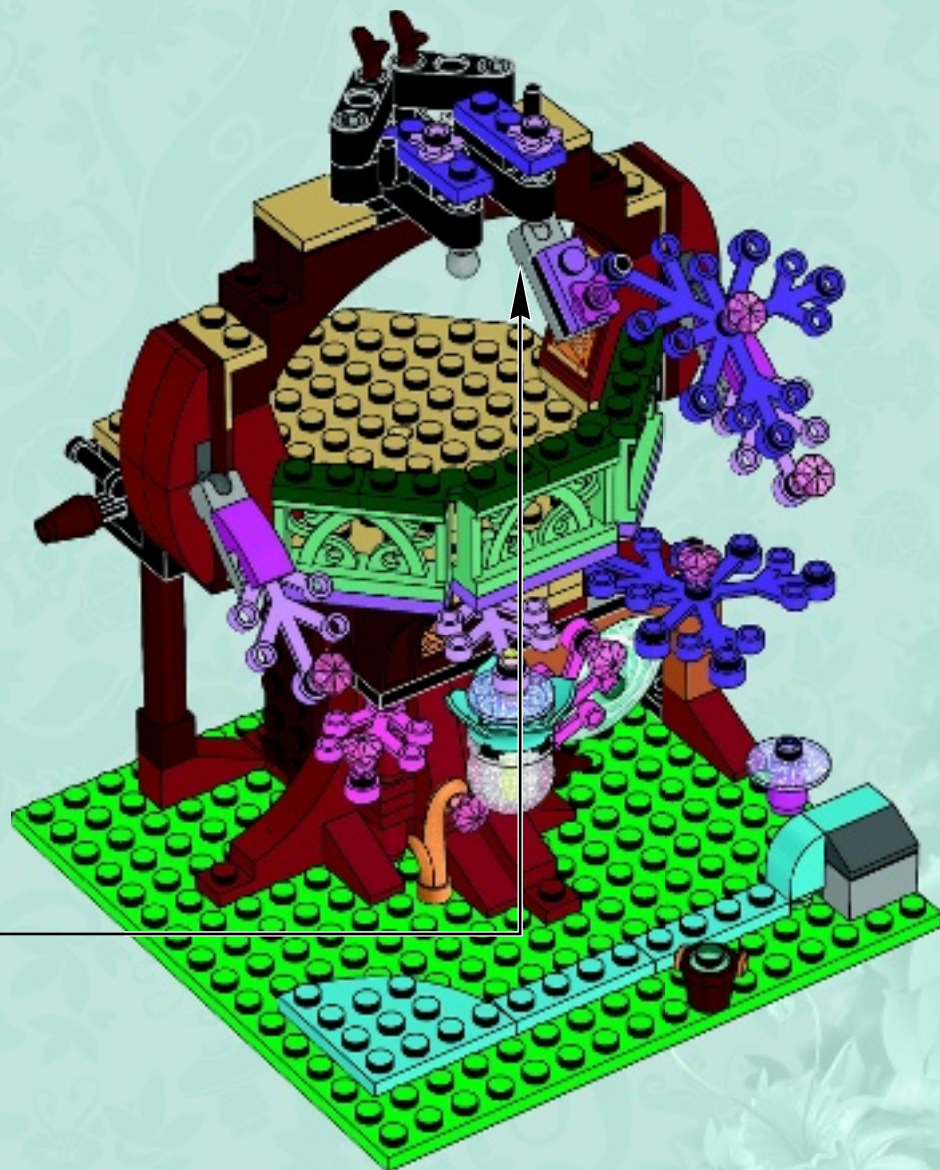

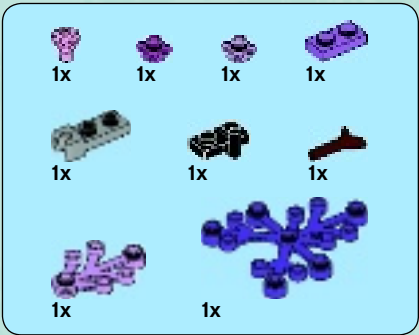

47

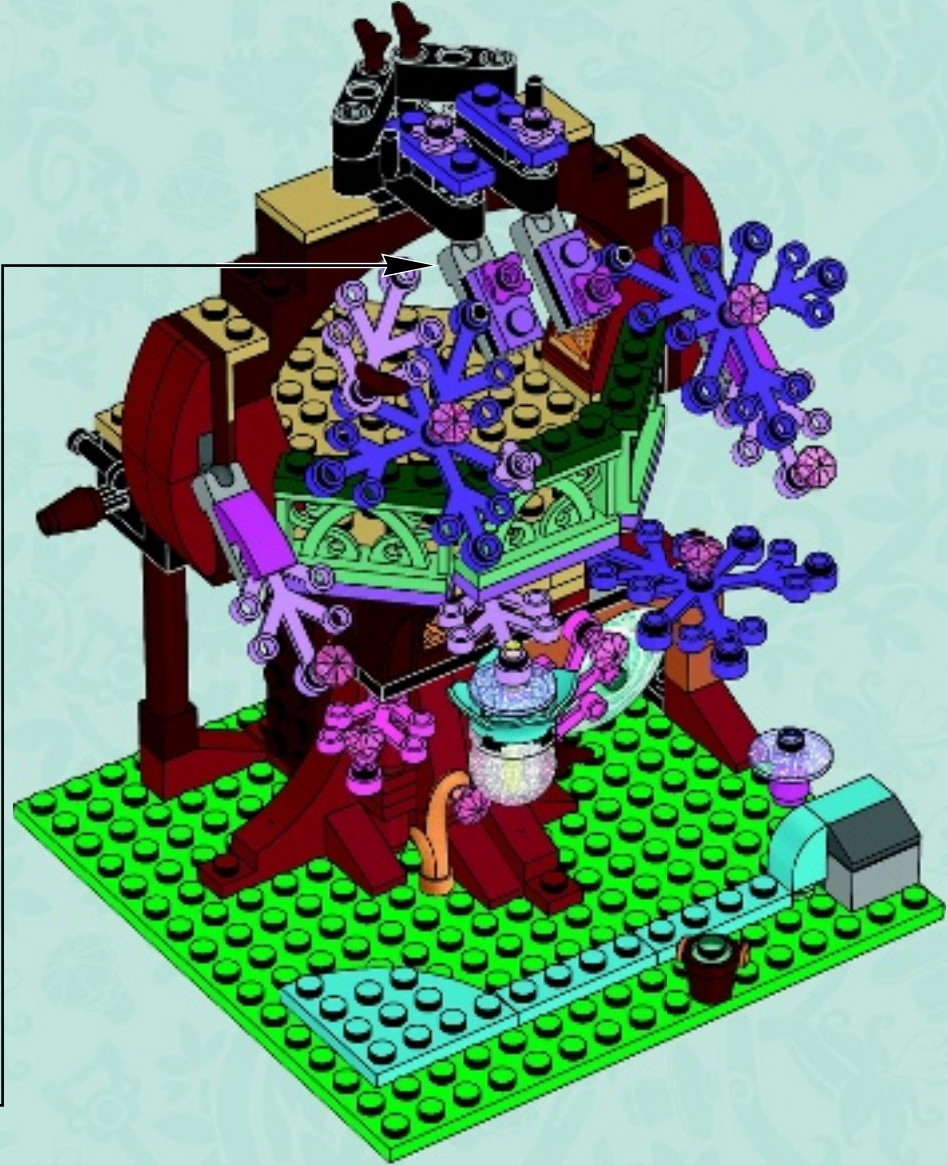

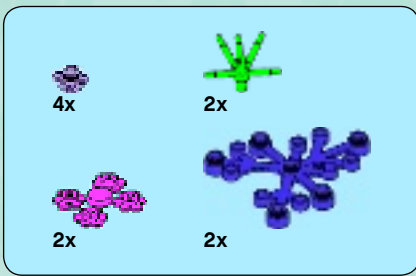

48

1



2



3

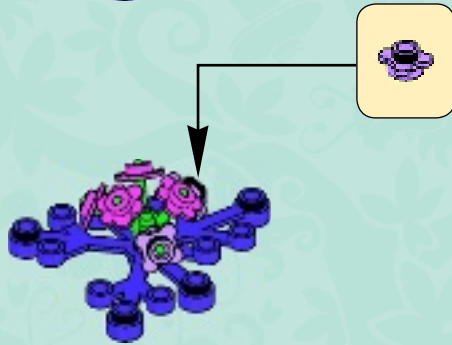

2x

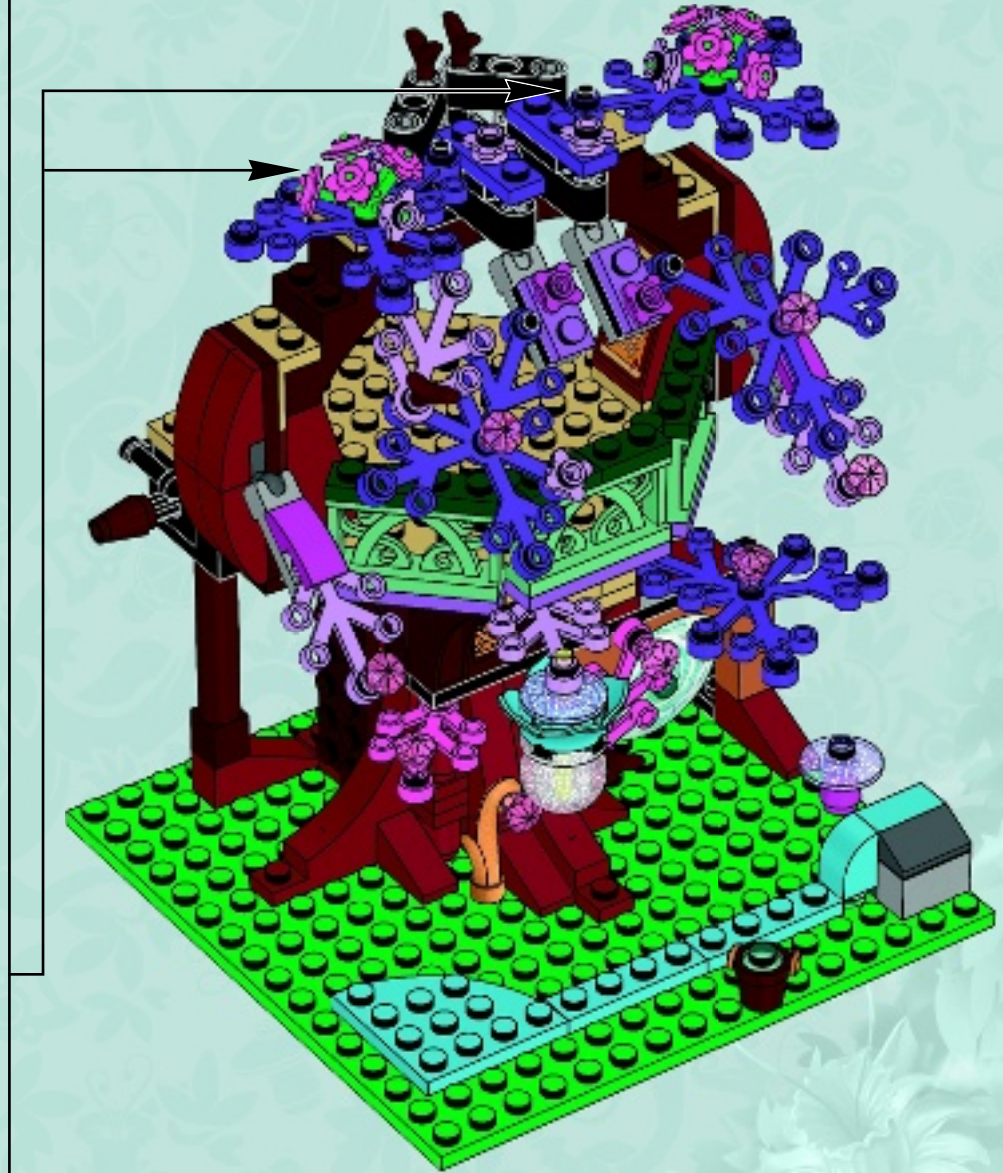

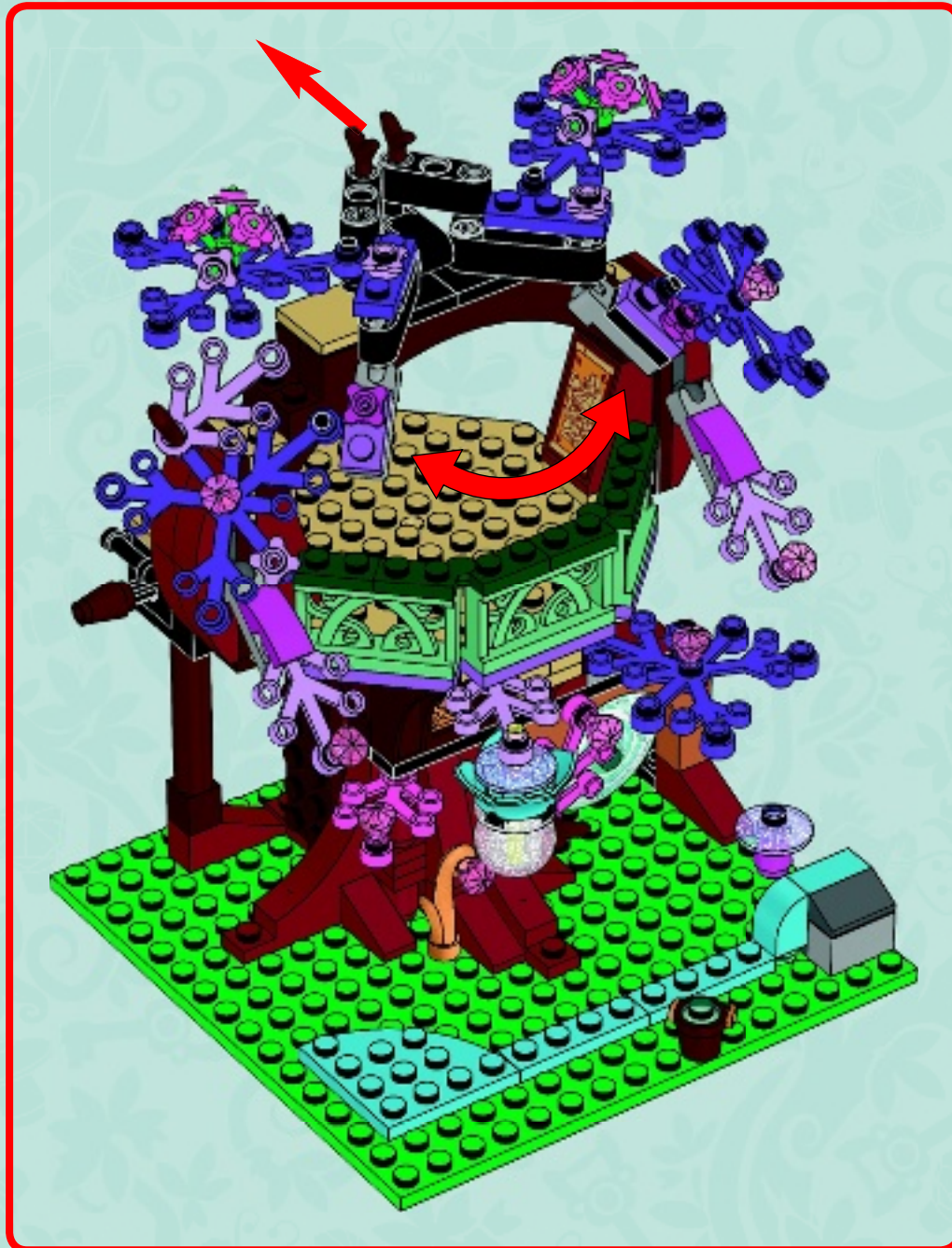

4x  5x 

49

1



2



3

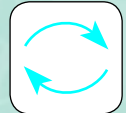

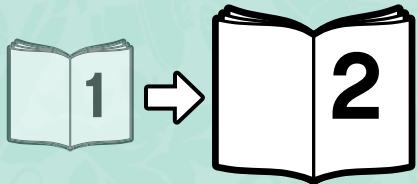



ELVES



Azari

Aira

Emily Jones

Farran

Naida

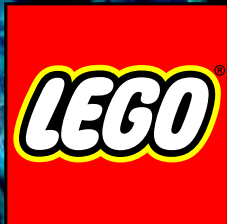

ELVES



Azari

Aira

Naida

Fanran

Emily Jones





ELVES



41071



41076



41075



41072



41073



41074

 LEGO.com/elves



ELVES

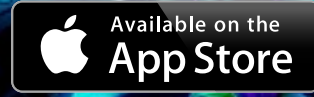

Apple, iPad and iPhone are trademarks of Apple Inc.
Google Play is a trademark of Google Inc.

WIN

GO TO WWW.LEGO.COM/PRODUCTFEEDBACK AND
GIVE US YOUR SHORT **FEEDBACK** ABOUT THIS
LEGO® SET FOR A CHANCE TO WIN
A COOL LEGO PRIZE.



LEGO.com/productfeedback

GEWINNE



Erzähle uns auf
www.LEGO.com/productfeedback

etwas über die Erfahrungen, die
du mit diesem LEGO® Set gemacht
hast, und sichere dir die Chance
auf einen coolen LEGO Preis!

GAGNE



Rends-toi sur
www.LEGO.com/productfeedback

et donne-nous quelques com-
mentaires sur ce produit LEGO®
pour avoir une chance de gagner
un prix LEGO !

GANAN



Visita
www.LEGO.com/productfeedback

y envíanos tu opinión acerca de
este set LEGO®. ¡Participarás en el
sorteo de un premio LEGO!

获取奖品



登录
www.LEGO.com/productfeedback

给出关于此乐高®套装的简短反馈，
就有机会获得炫酷乐高奖品

경품 당첨 기회



www.LEGO.com/productfeedback

페이지로 이동하여 이 레고® 세트에
대한 간략한 피드백을 보내 주시고
멋진 레고 경품을 탈 수 있는 기회도
잡으십시오

ЗАПОЛНИ АНКЕТУ И ПОЛУЧИ ПРИЗ



Перейди по ссылке
www.LEGO.com/productfeedback

ответь всего на несколько во-
просов об этом наборе LEGO®,
и у тебя появится шанс выиграть
замечательный приз от компании
LEGO.

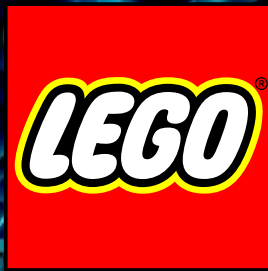

ELVES

41075



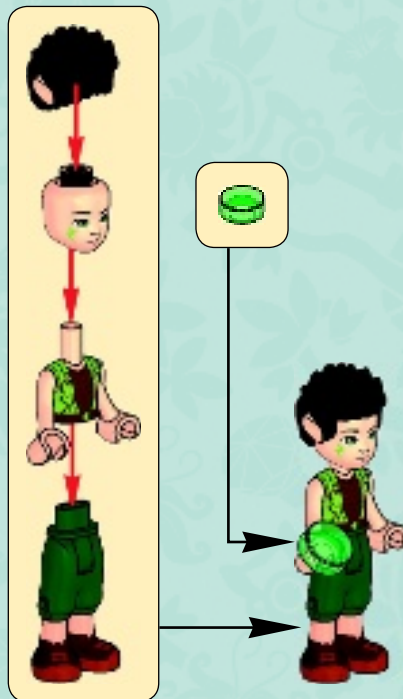
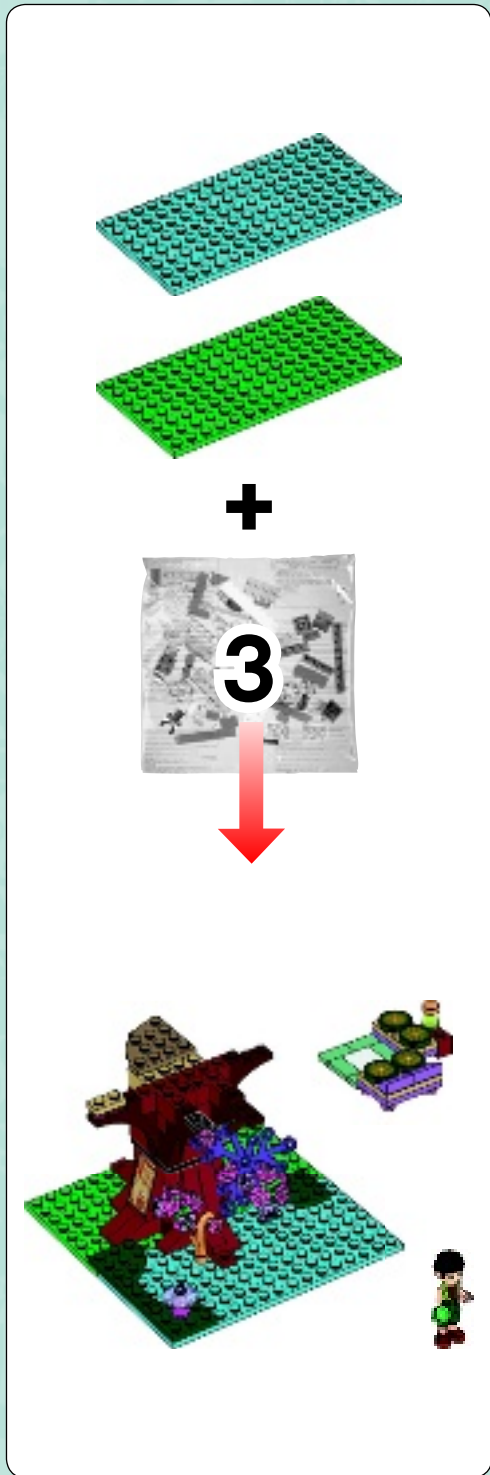



50





1x



1x



1x

51

1



2



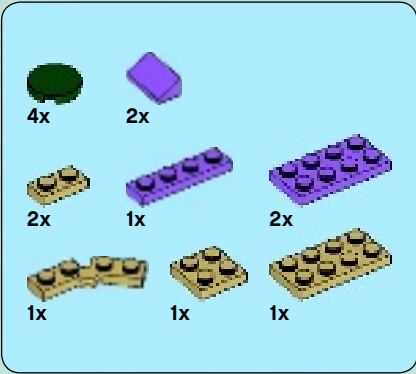

52

1

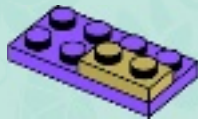

2



3



4



5



6



7

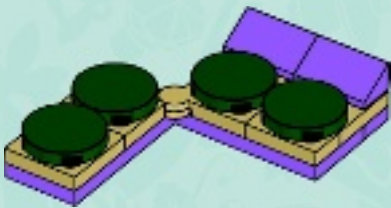

8

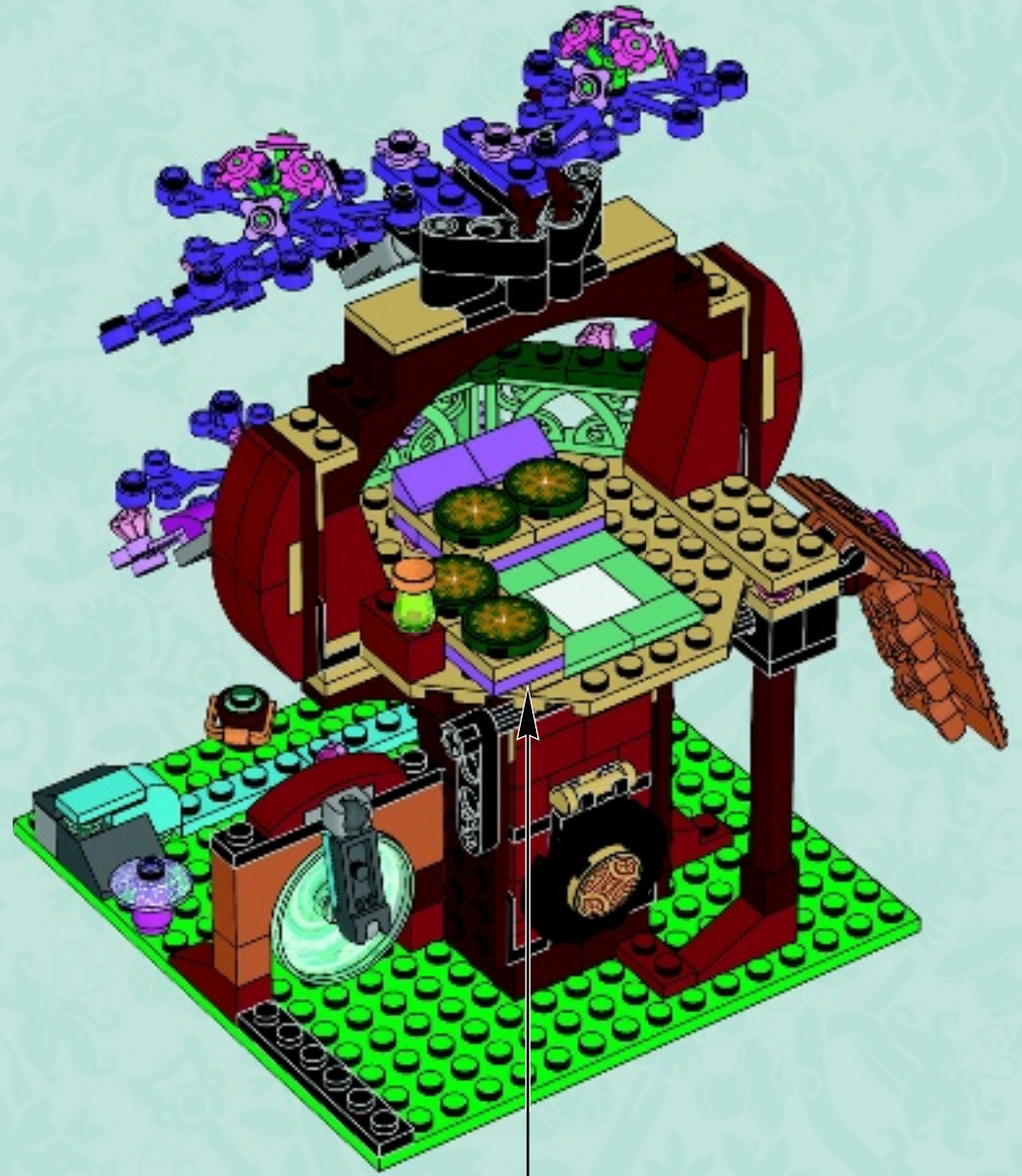
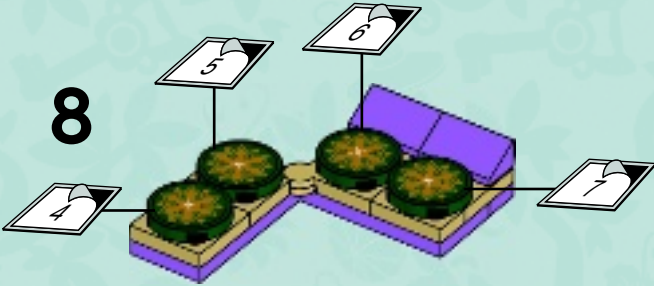

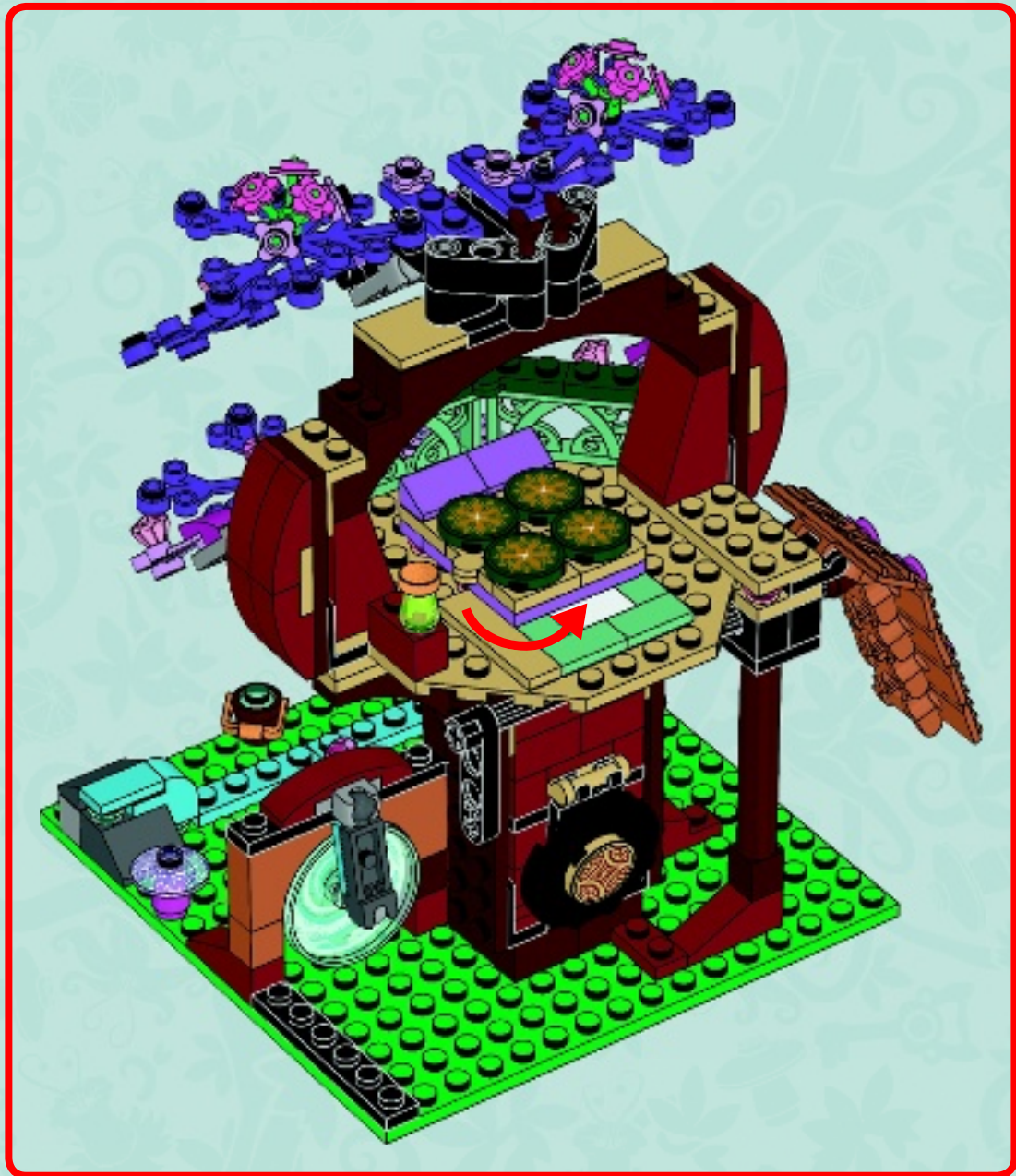

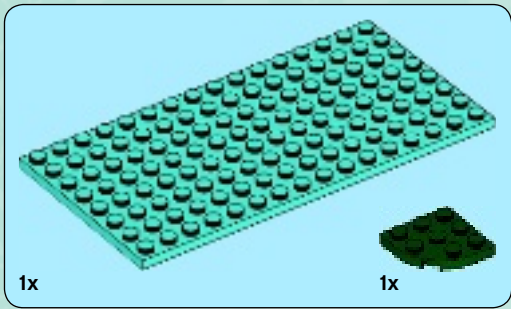

1

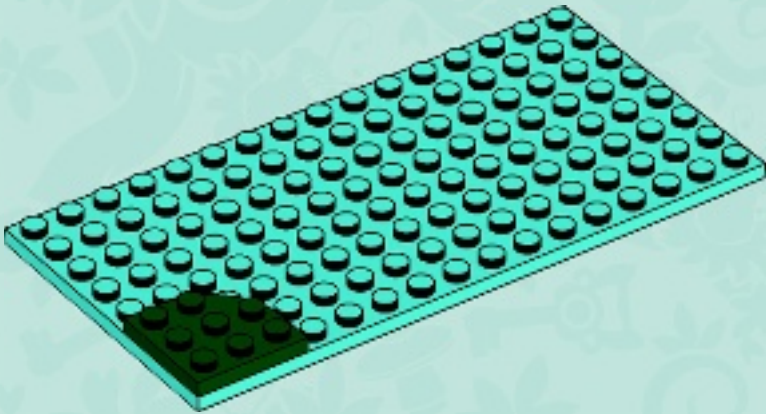

2

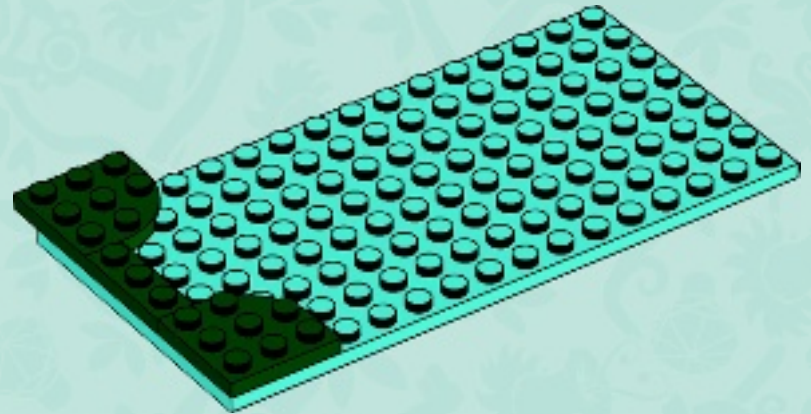

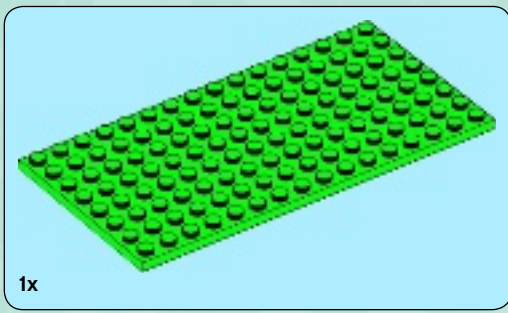

3

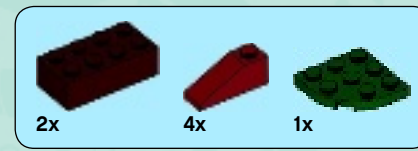
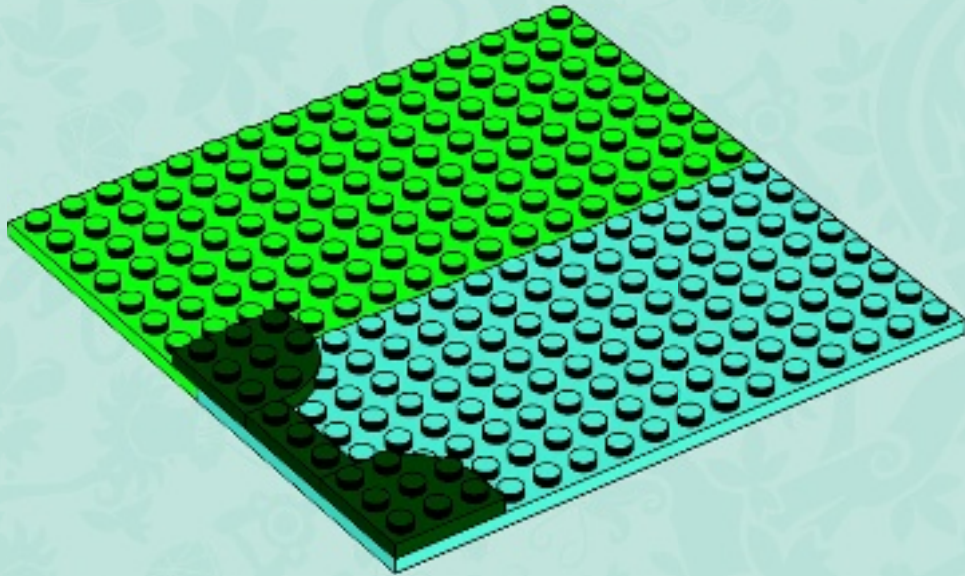

4

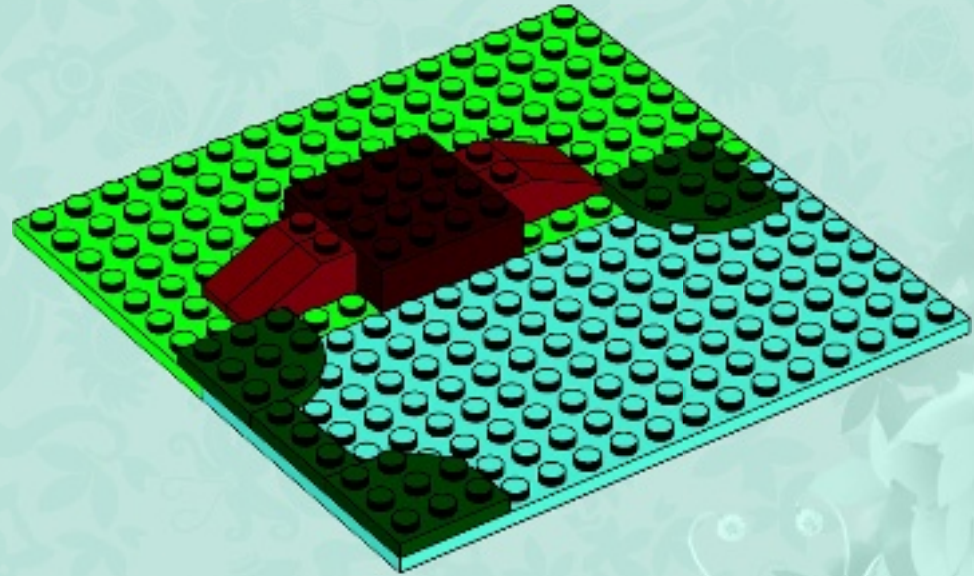



5

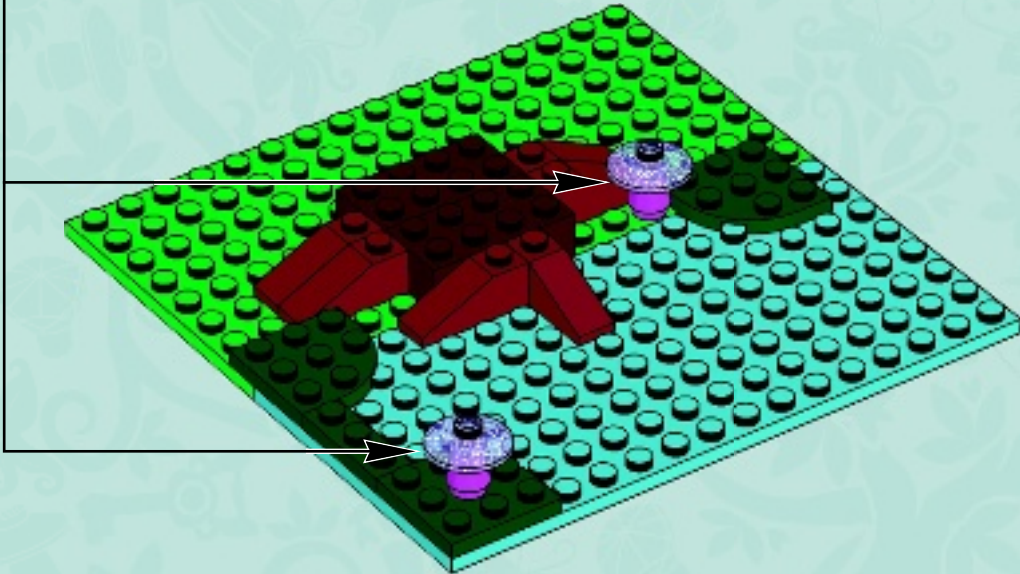

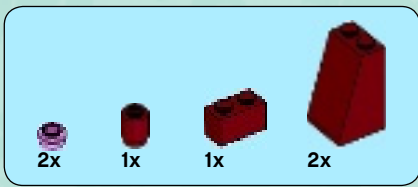

6

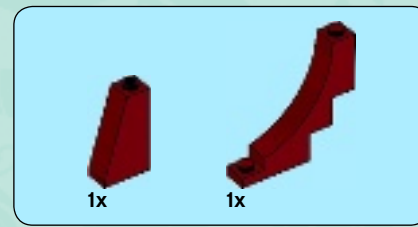
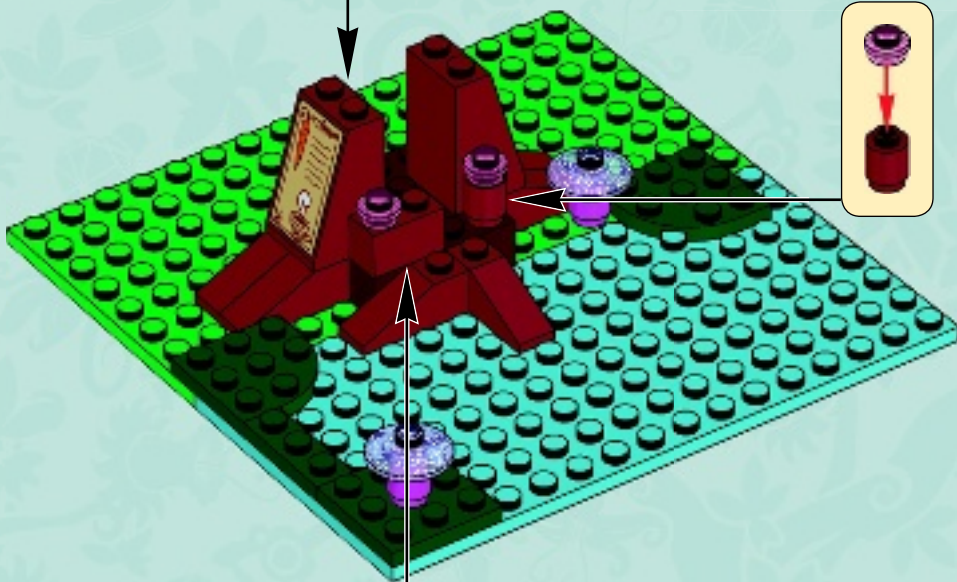

7





8

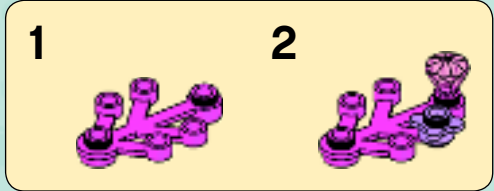
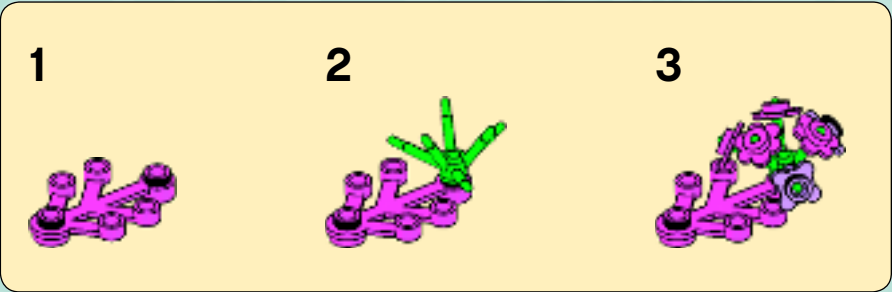

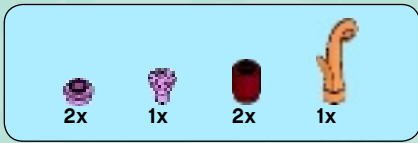

9

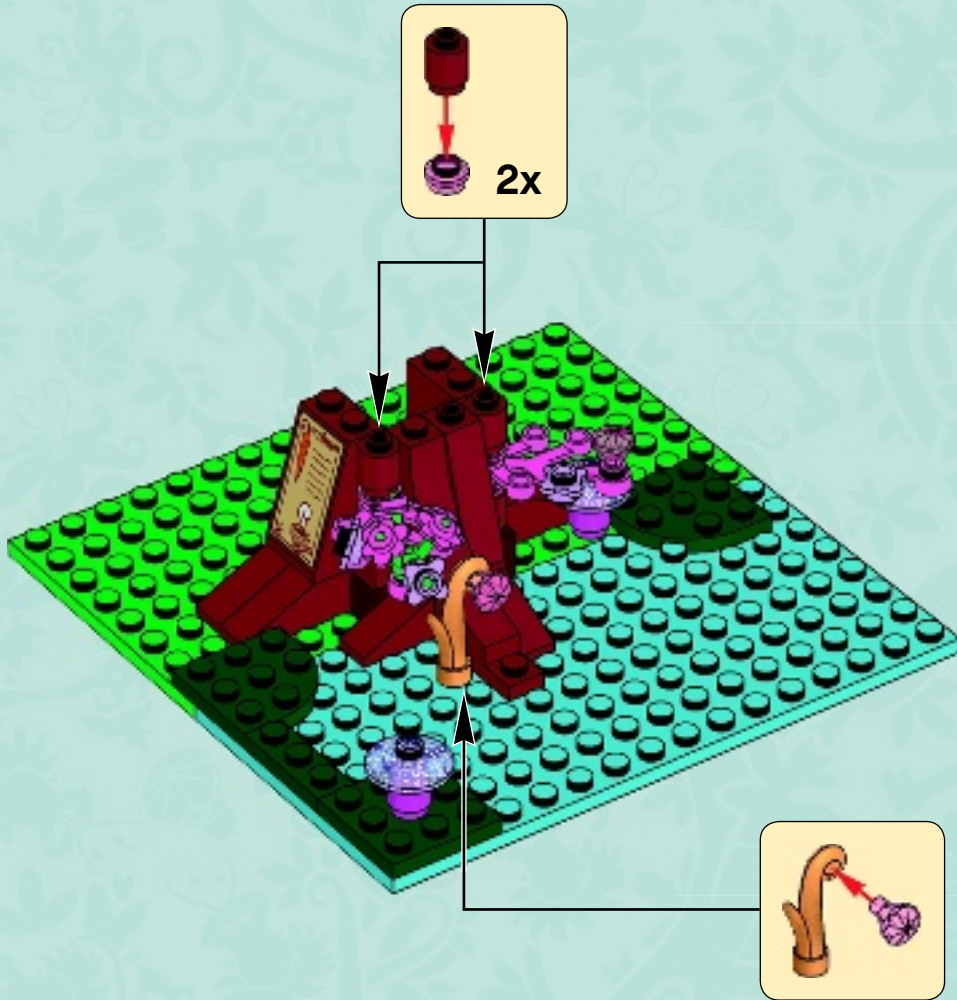

10

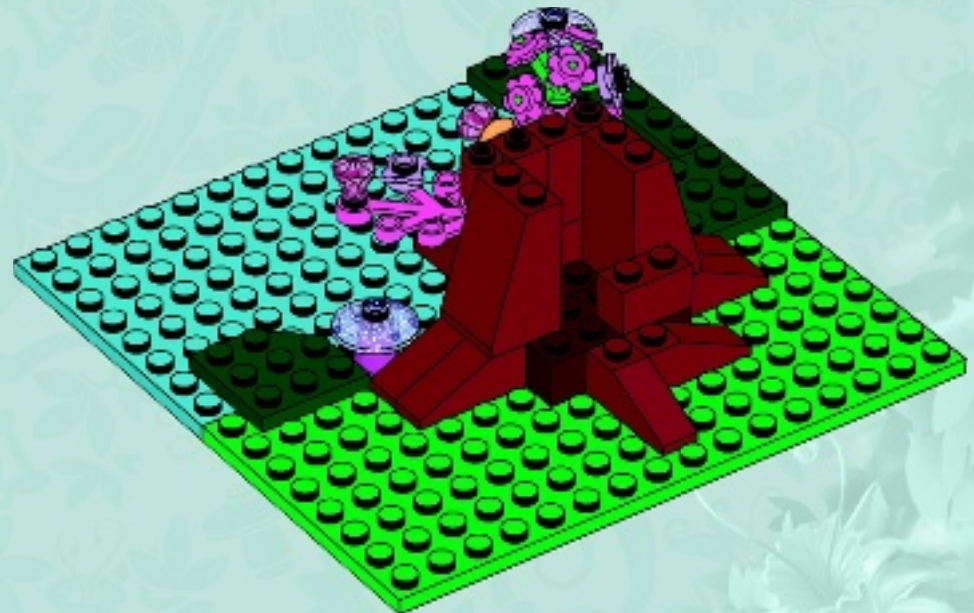
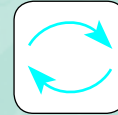

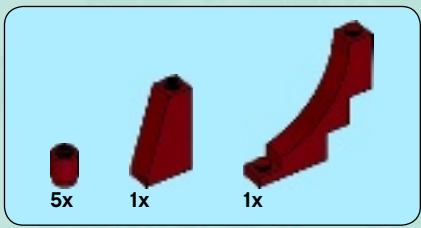

11

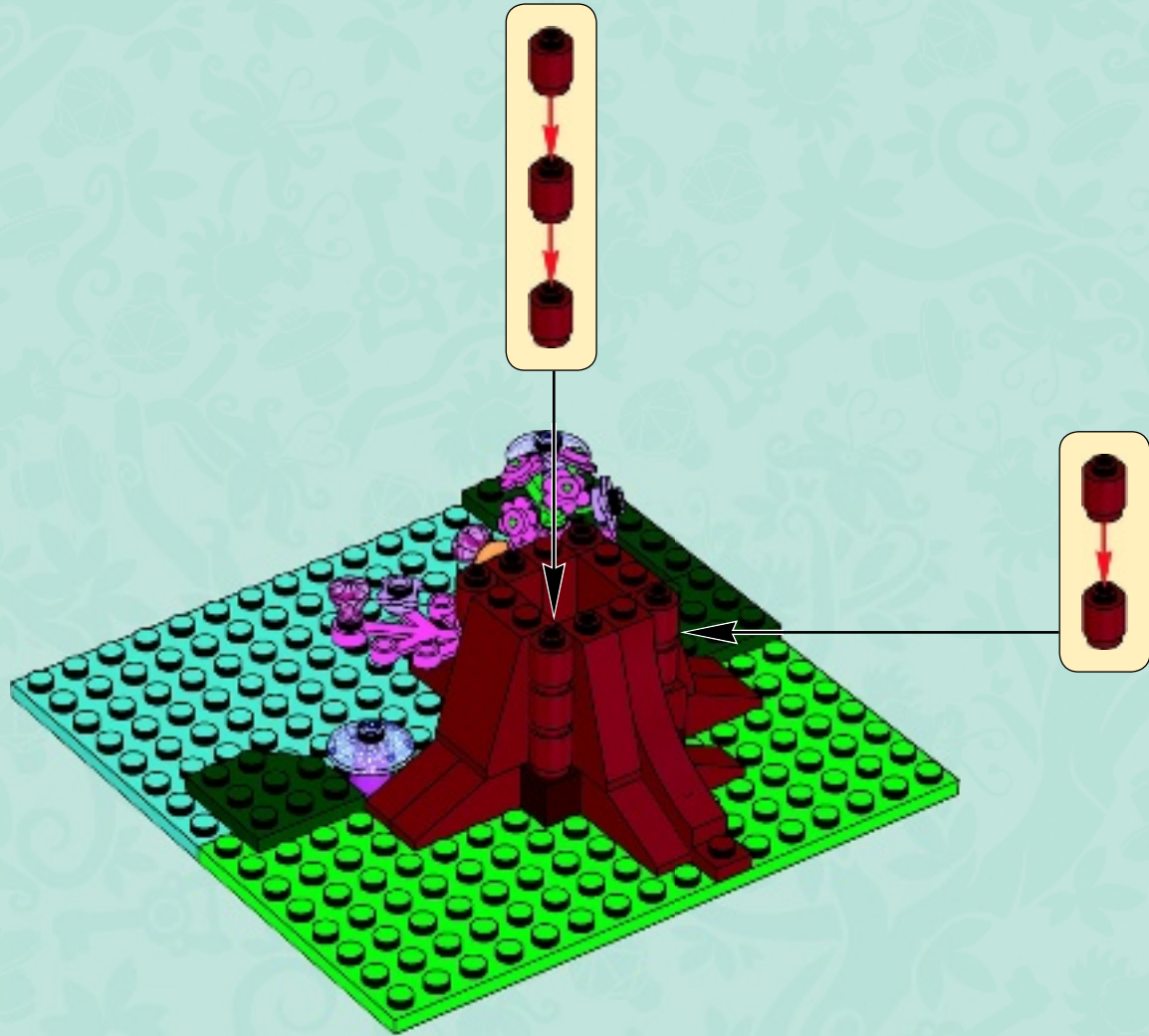



12

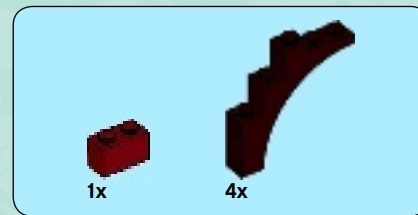

13

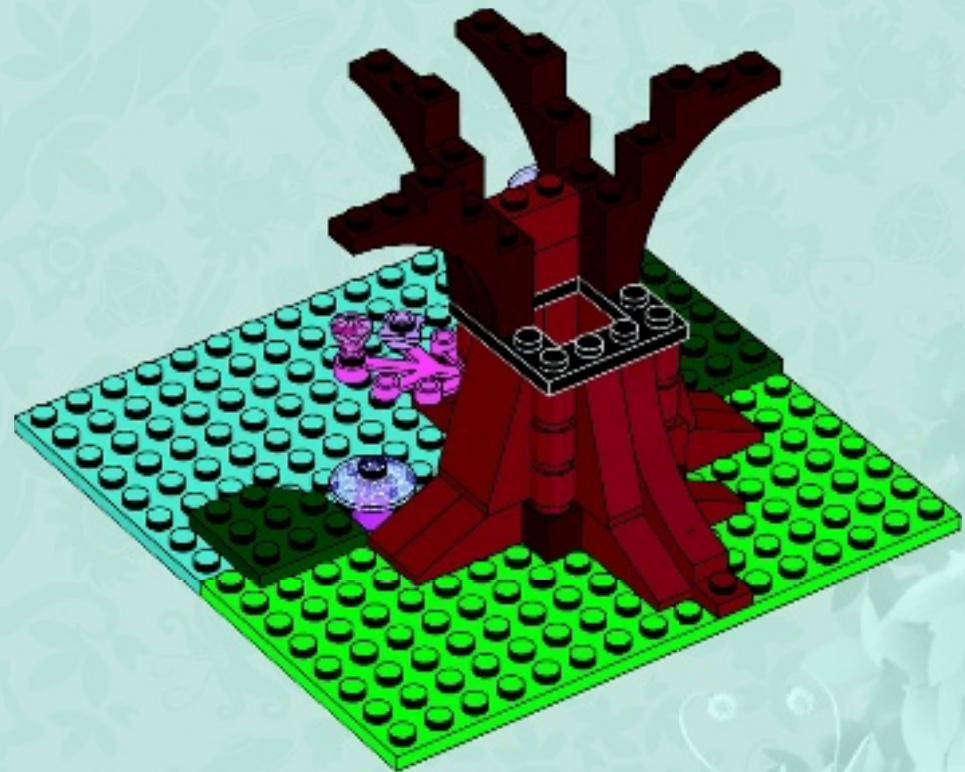



4x

14

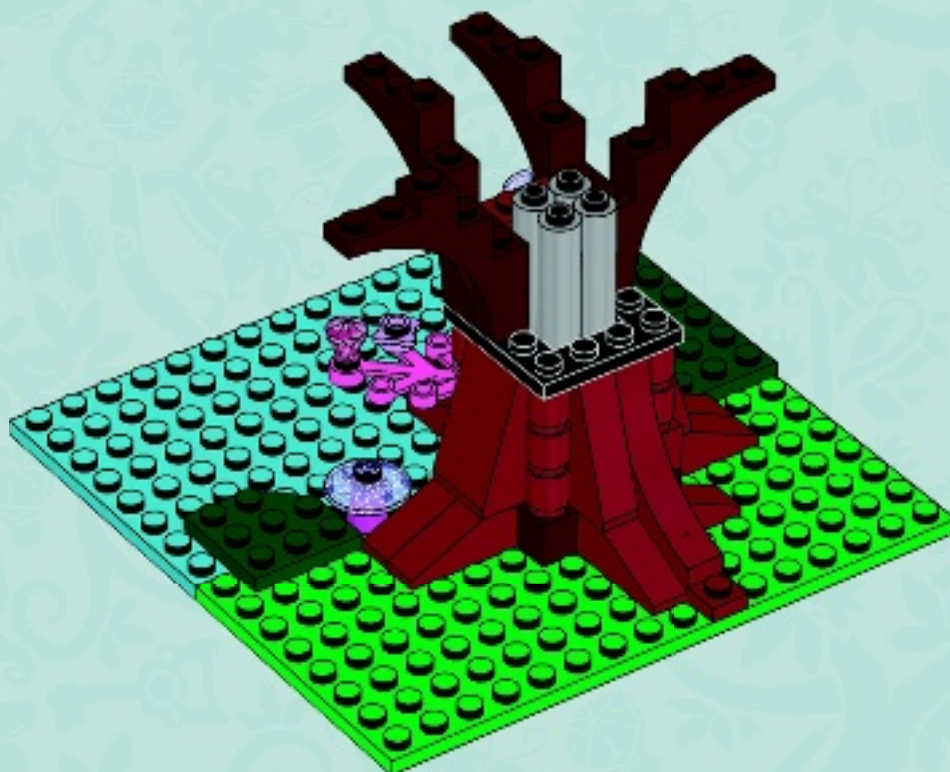



15

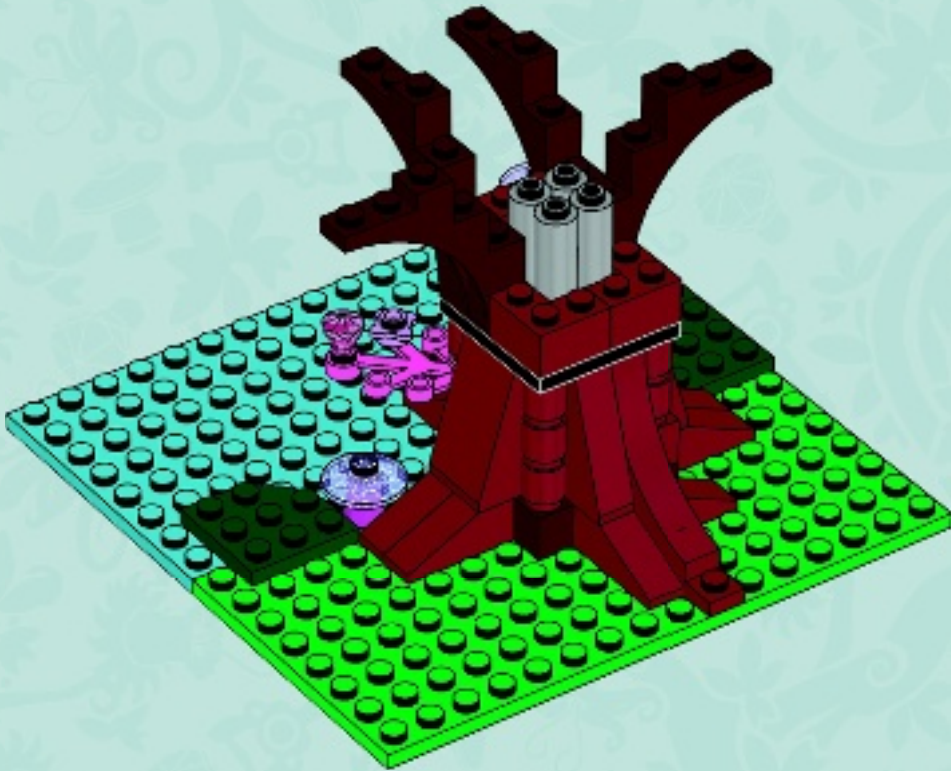

16

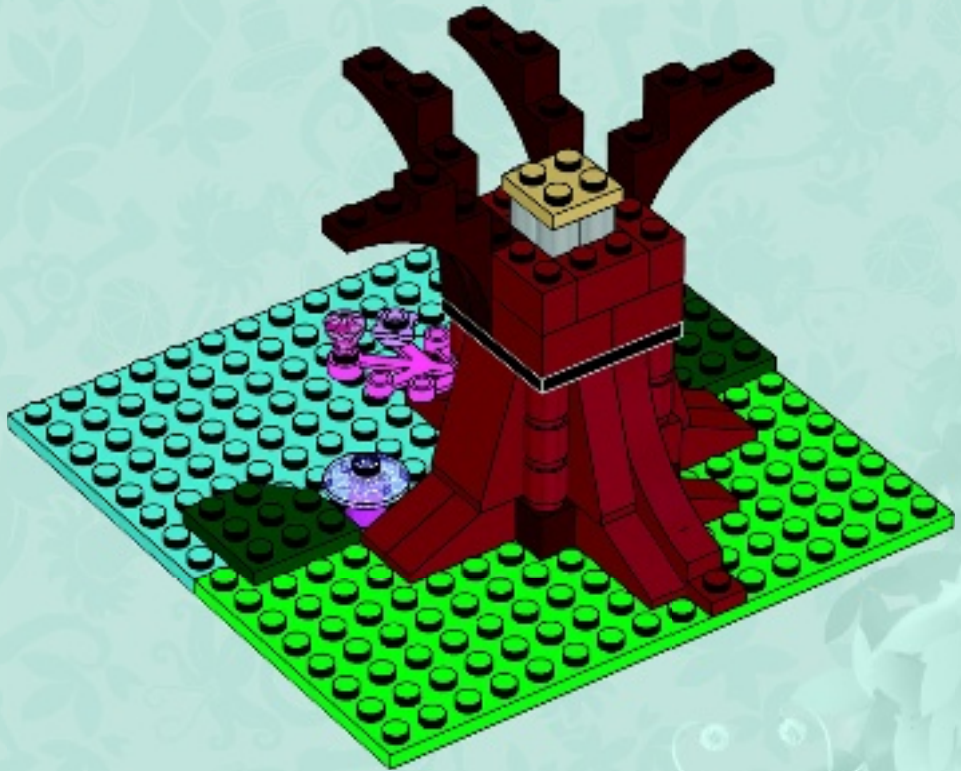



17

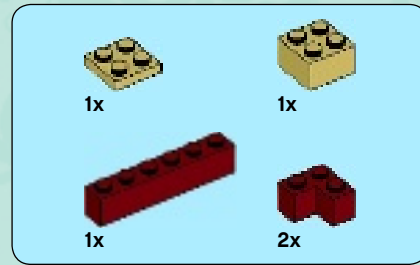
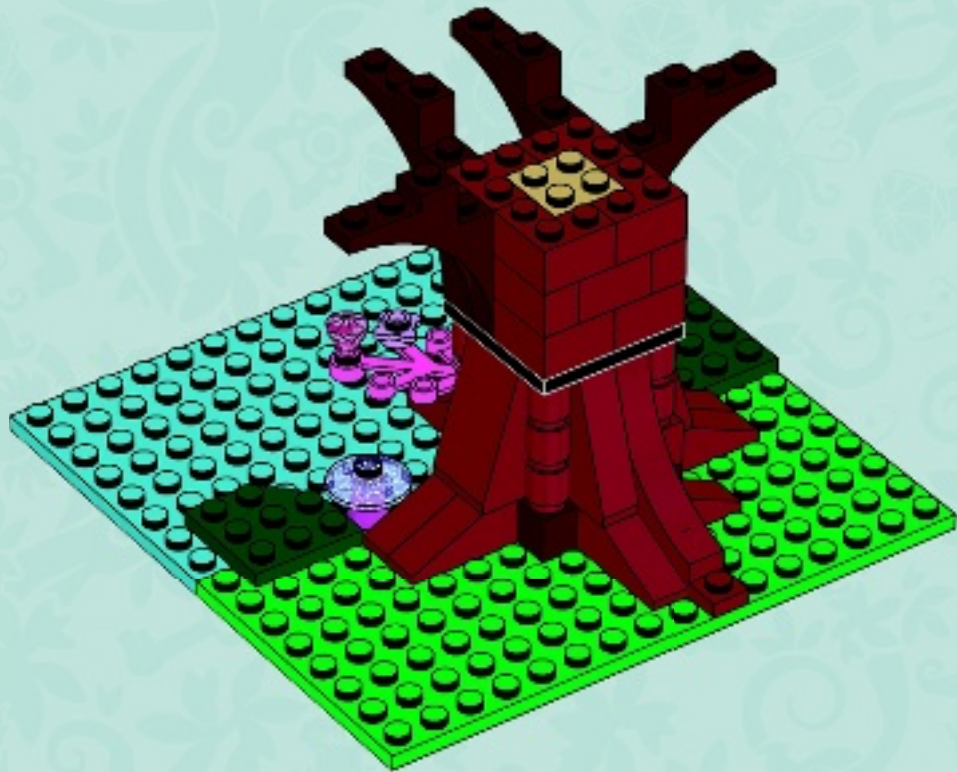

18

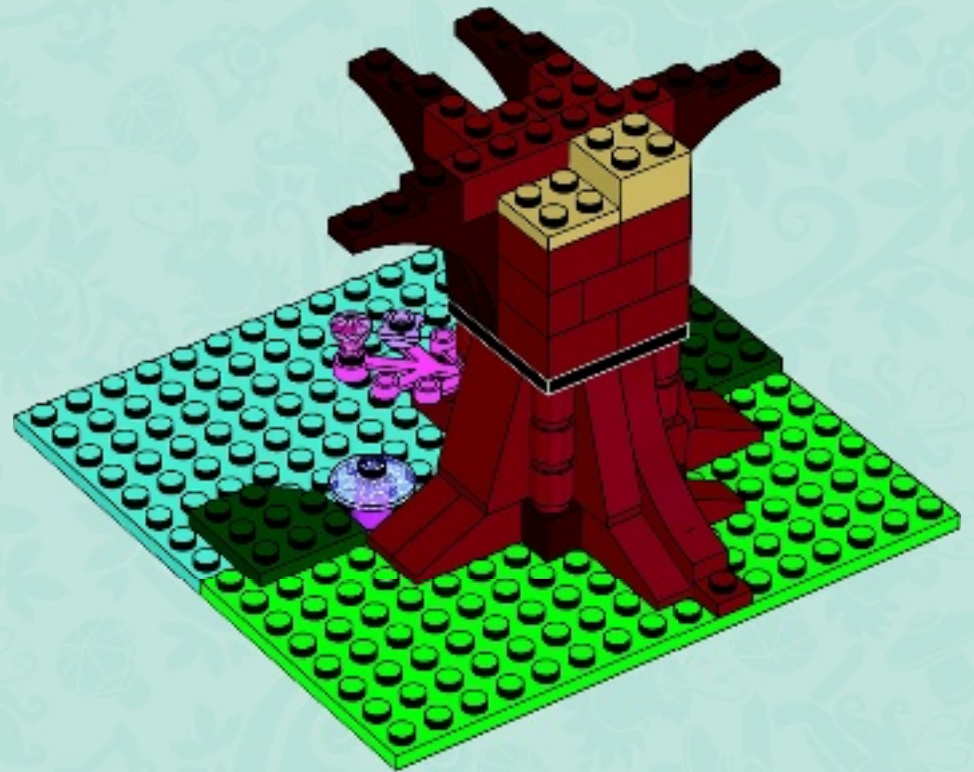

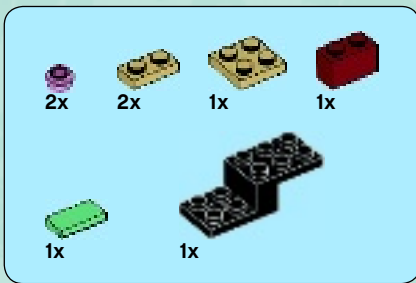

19

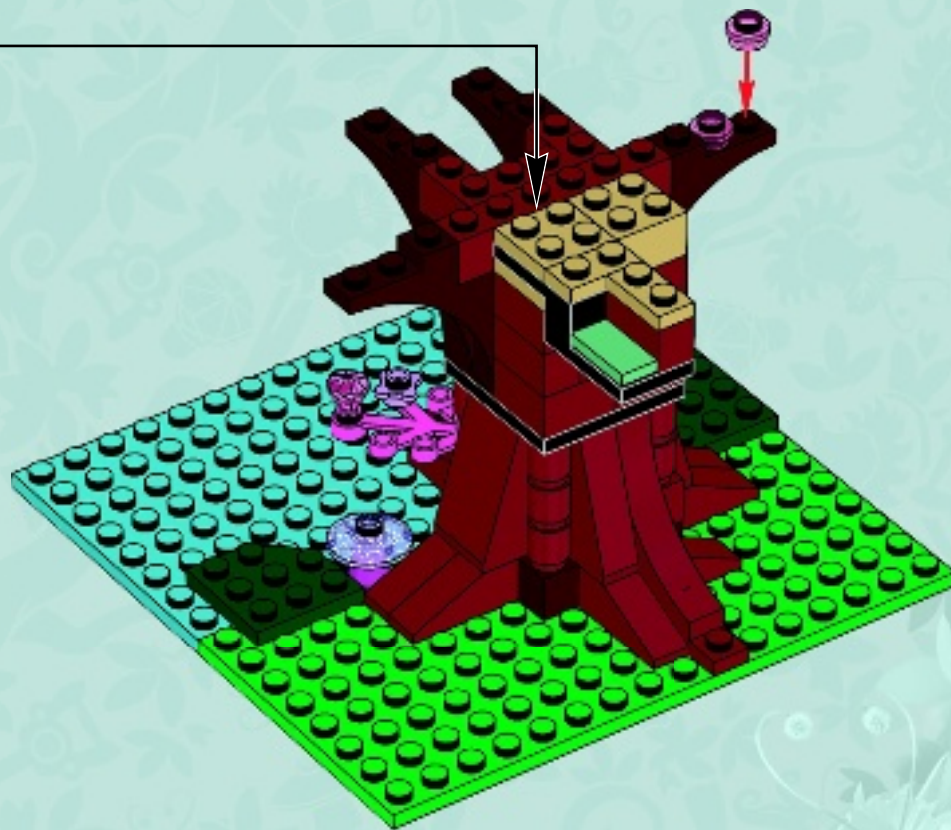
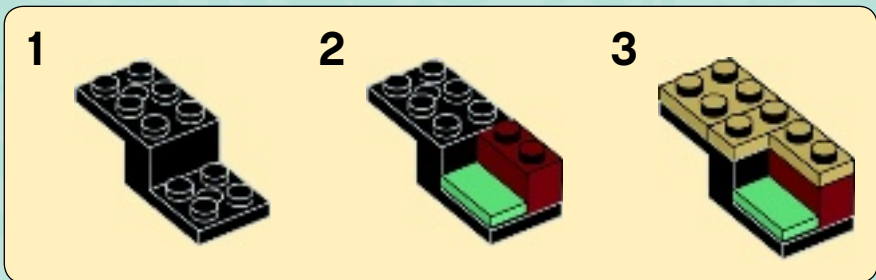

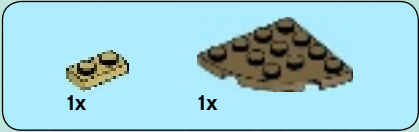

20

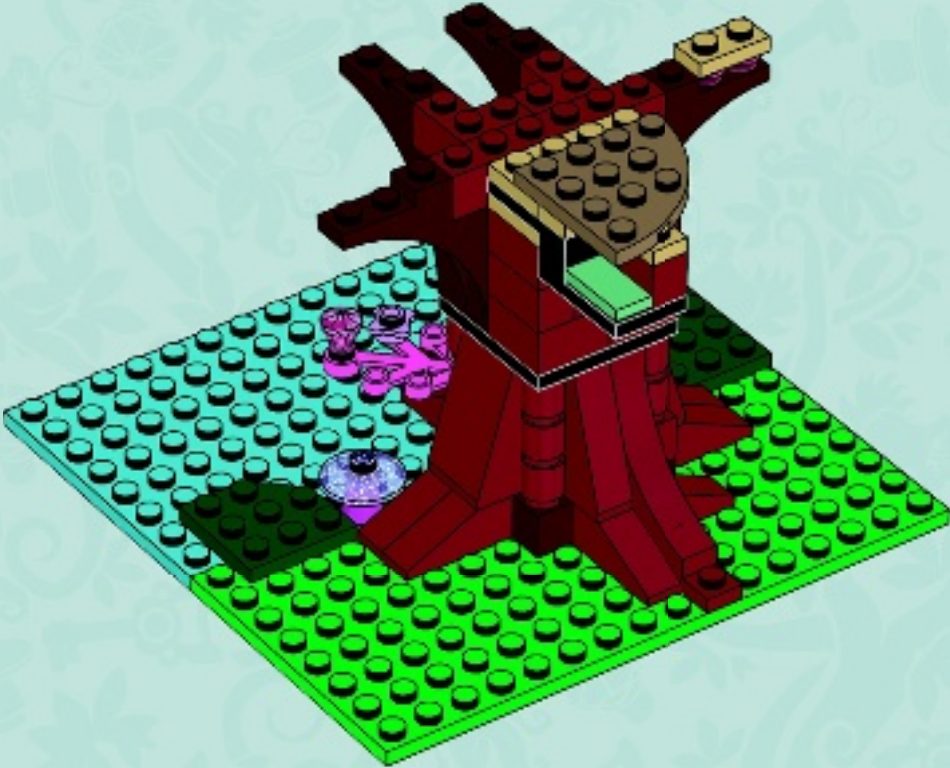

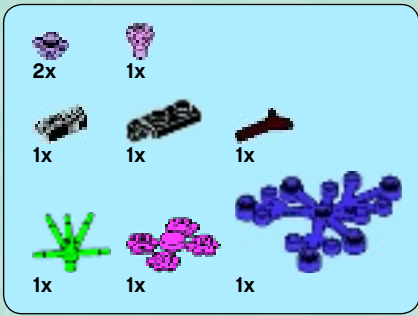

21

1



2



3



4



5

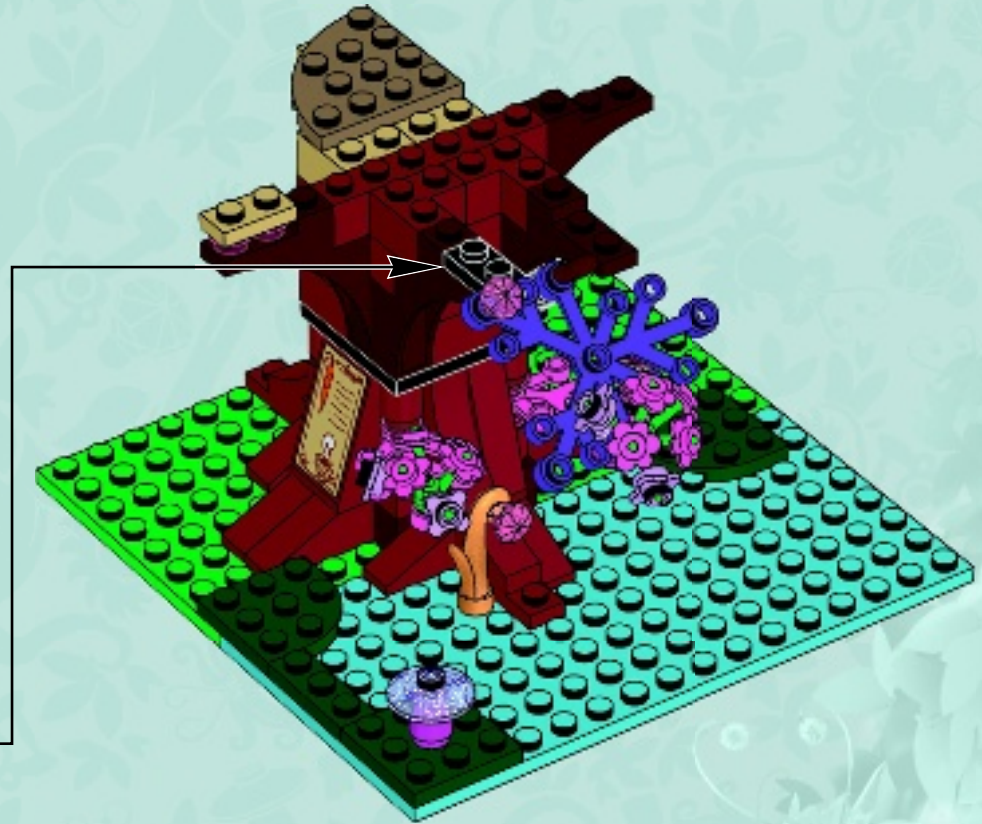
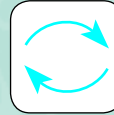

4



1x

1x



2x

2x

1x

2



2x

2x

3

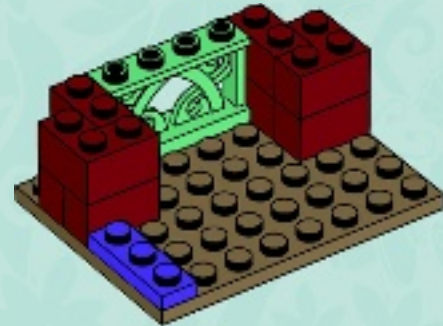

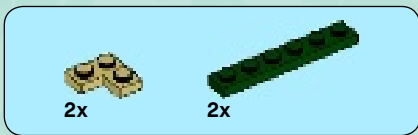

4

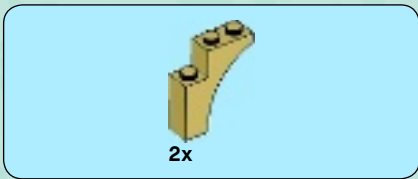

5

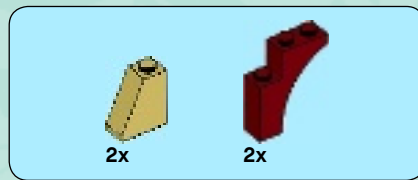

6

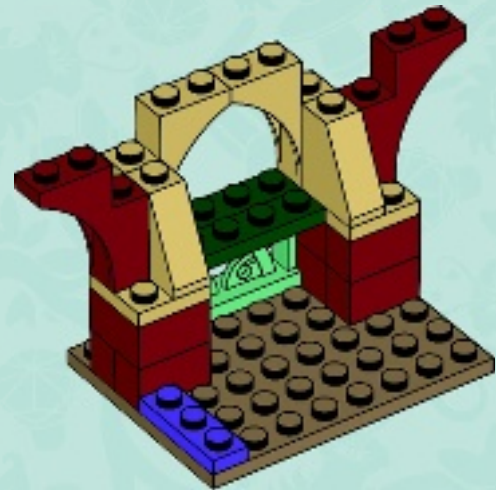



7



8

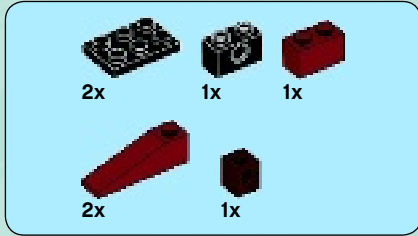
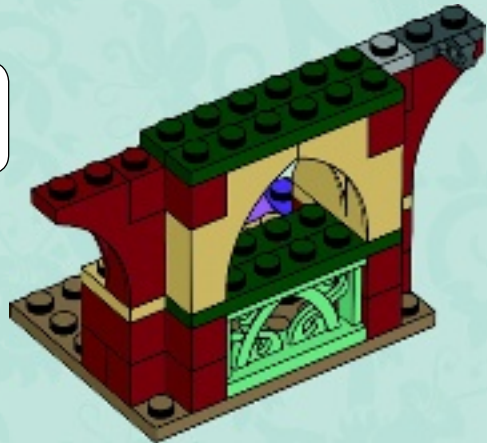

9

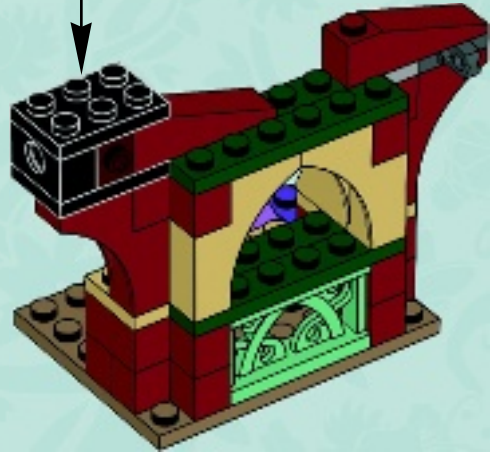
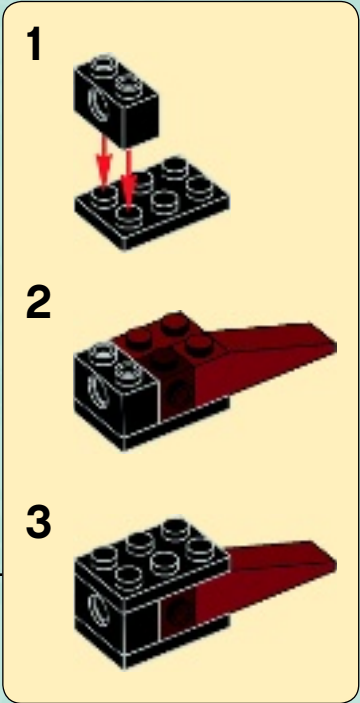



10



11



12

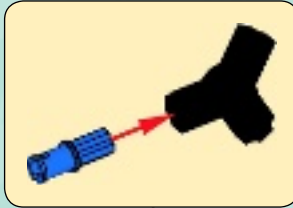

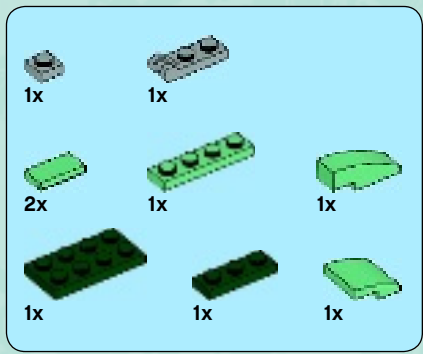

13

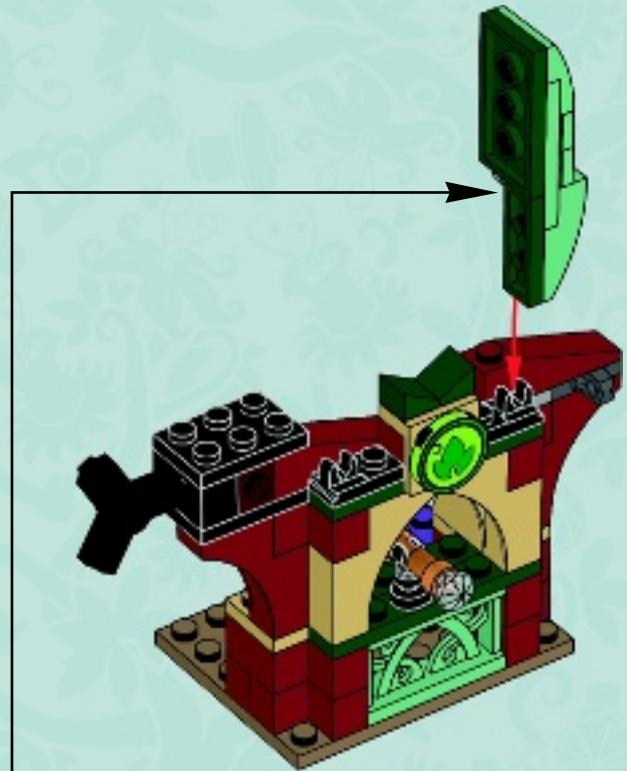
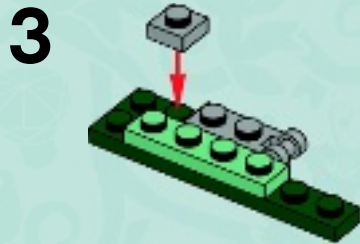
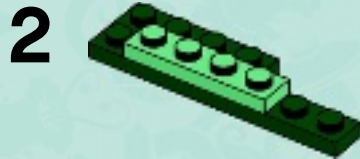
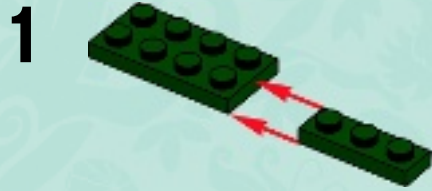

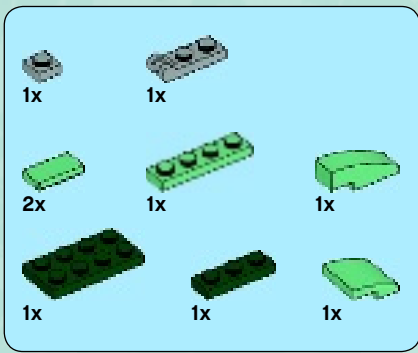

14

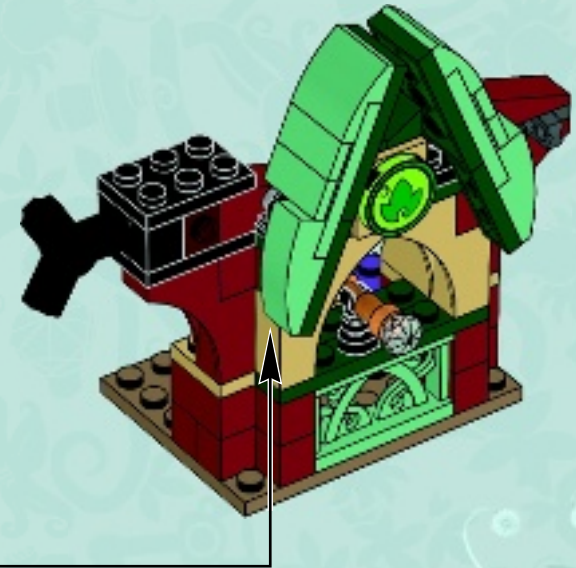
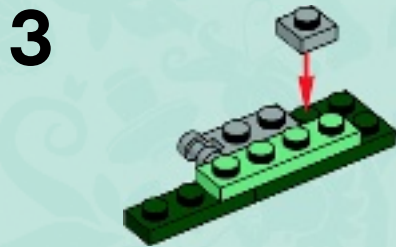
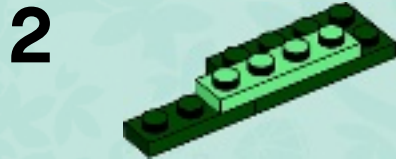
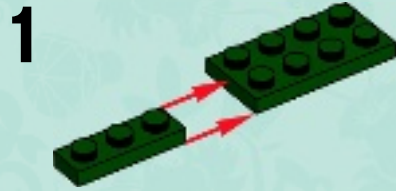

22

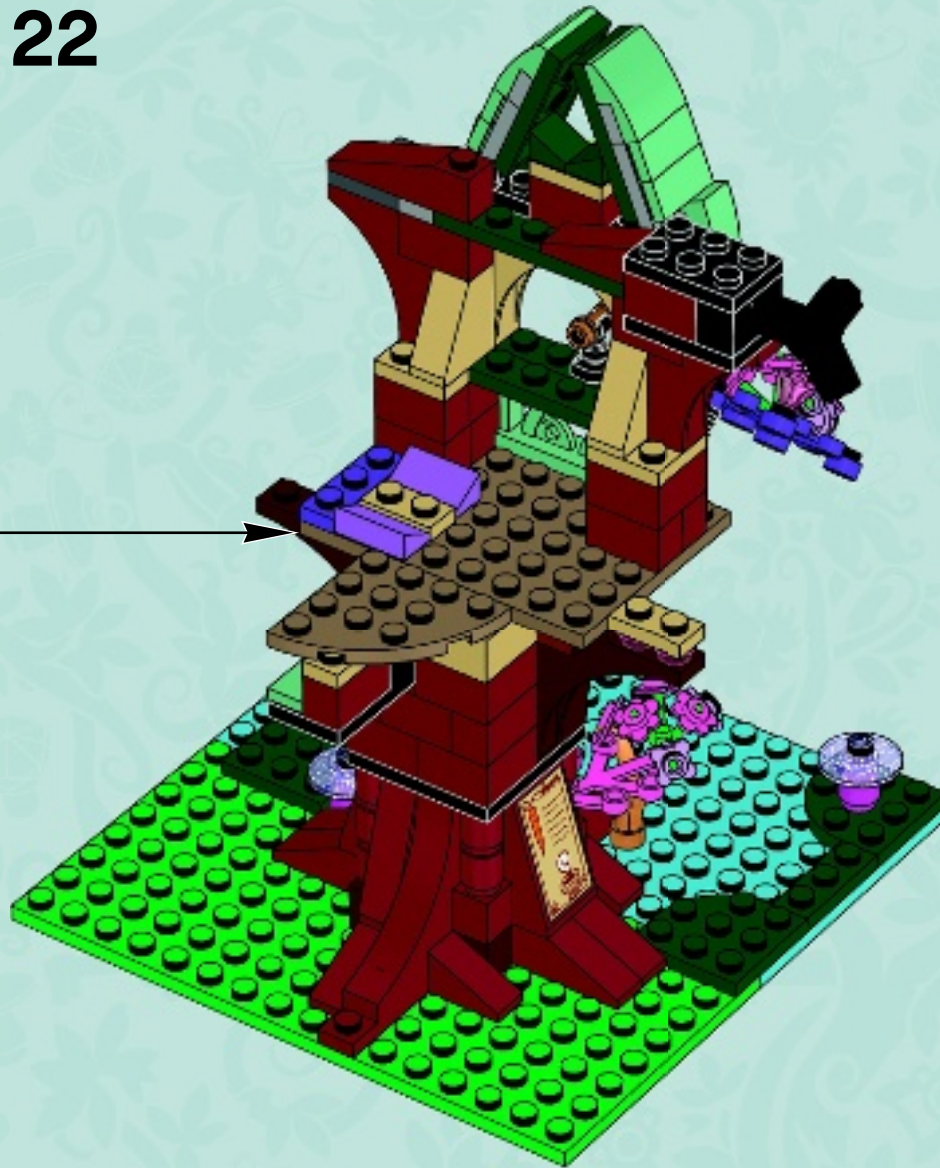
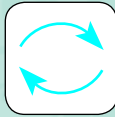



23

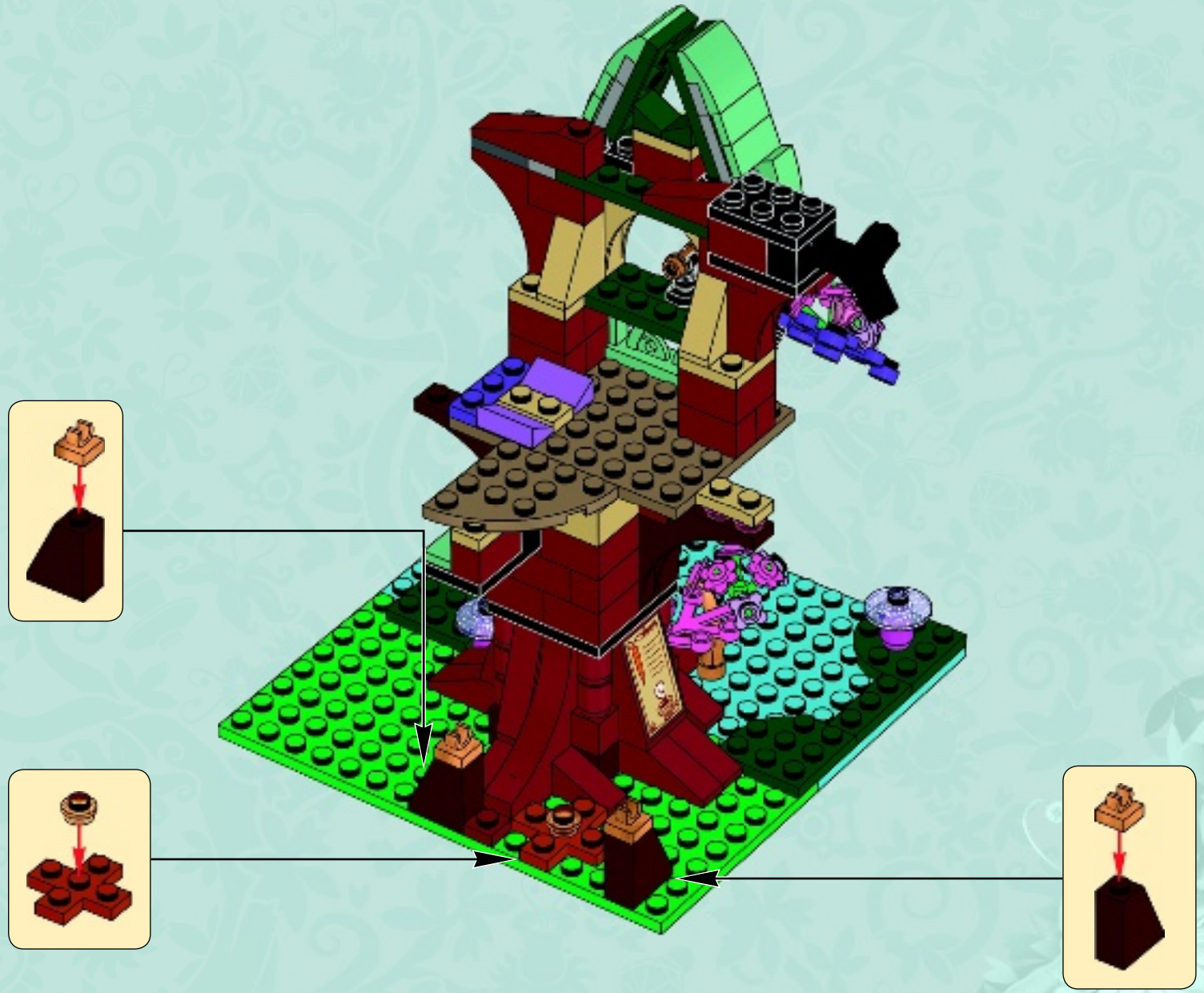

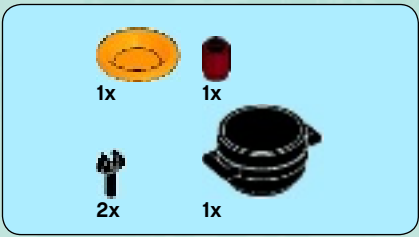

24

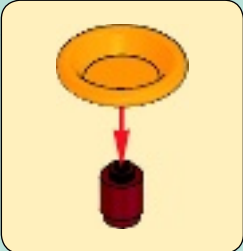
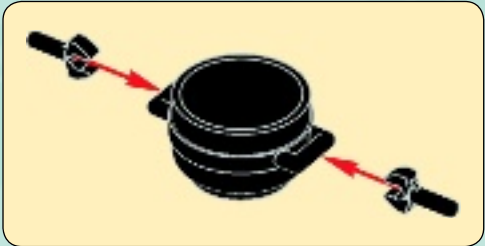

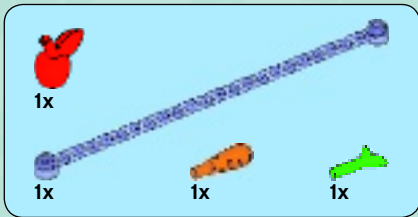

25

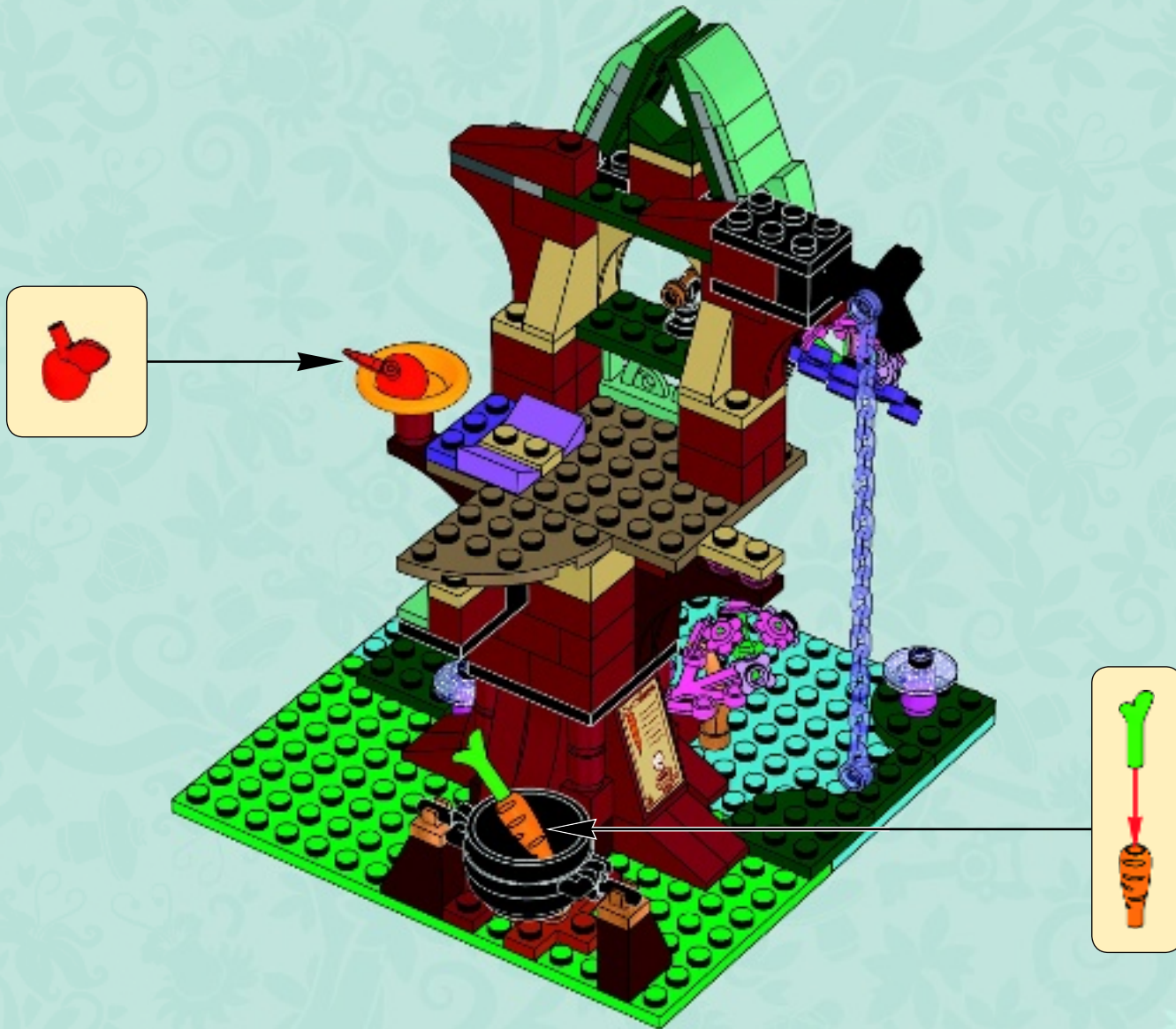

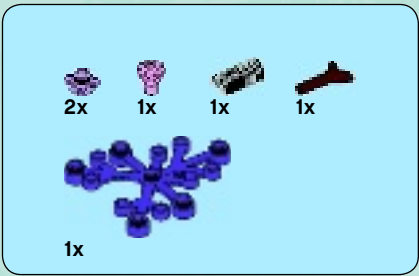

26

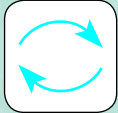
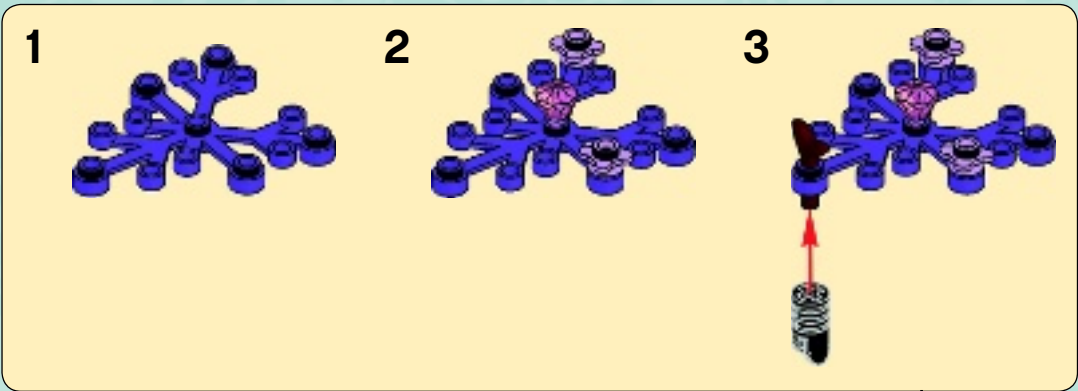

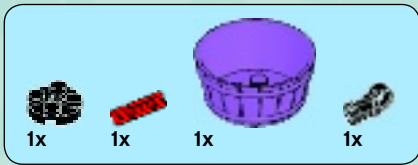

27

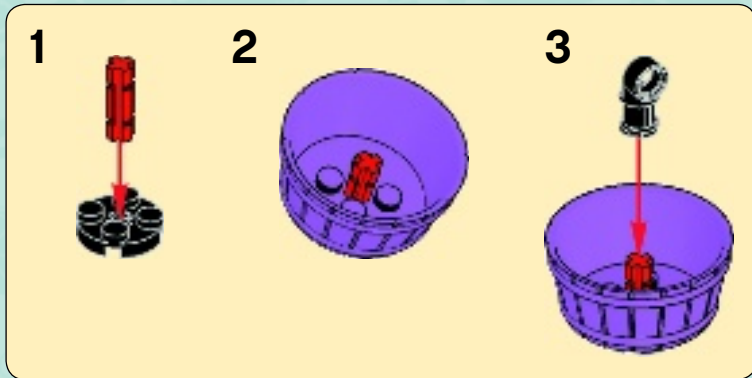

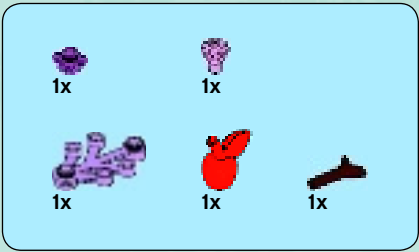

28

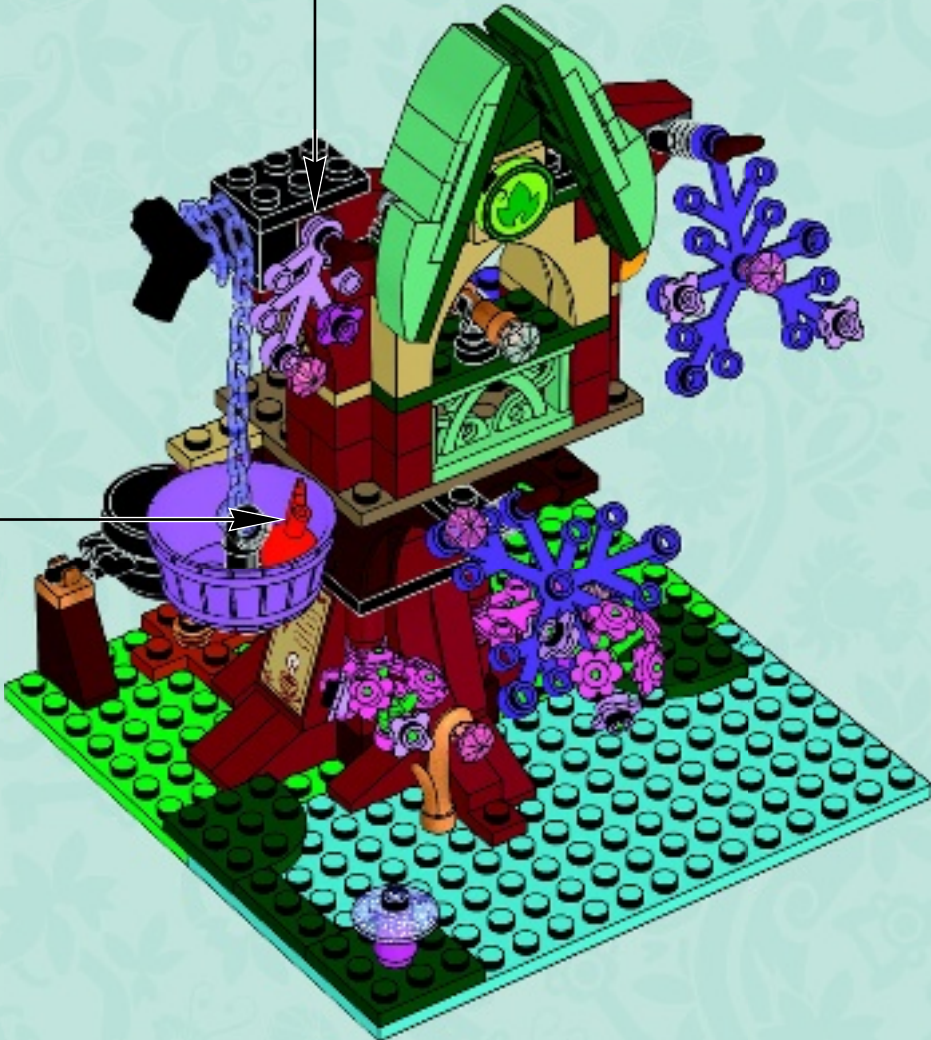
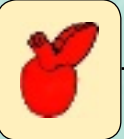
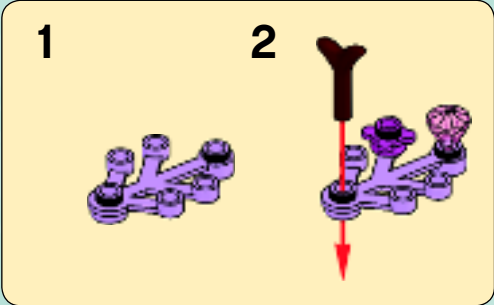

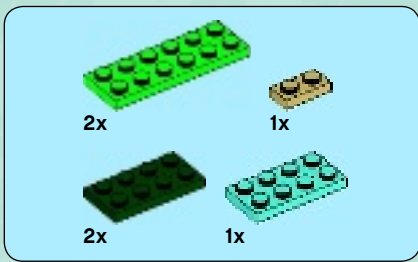

29



53





54

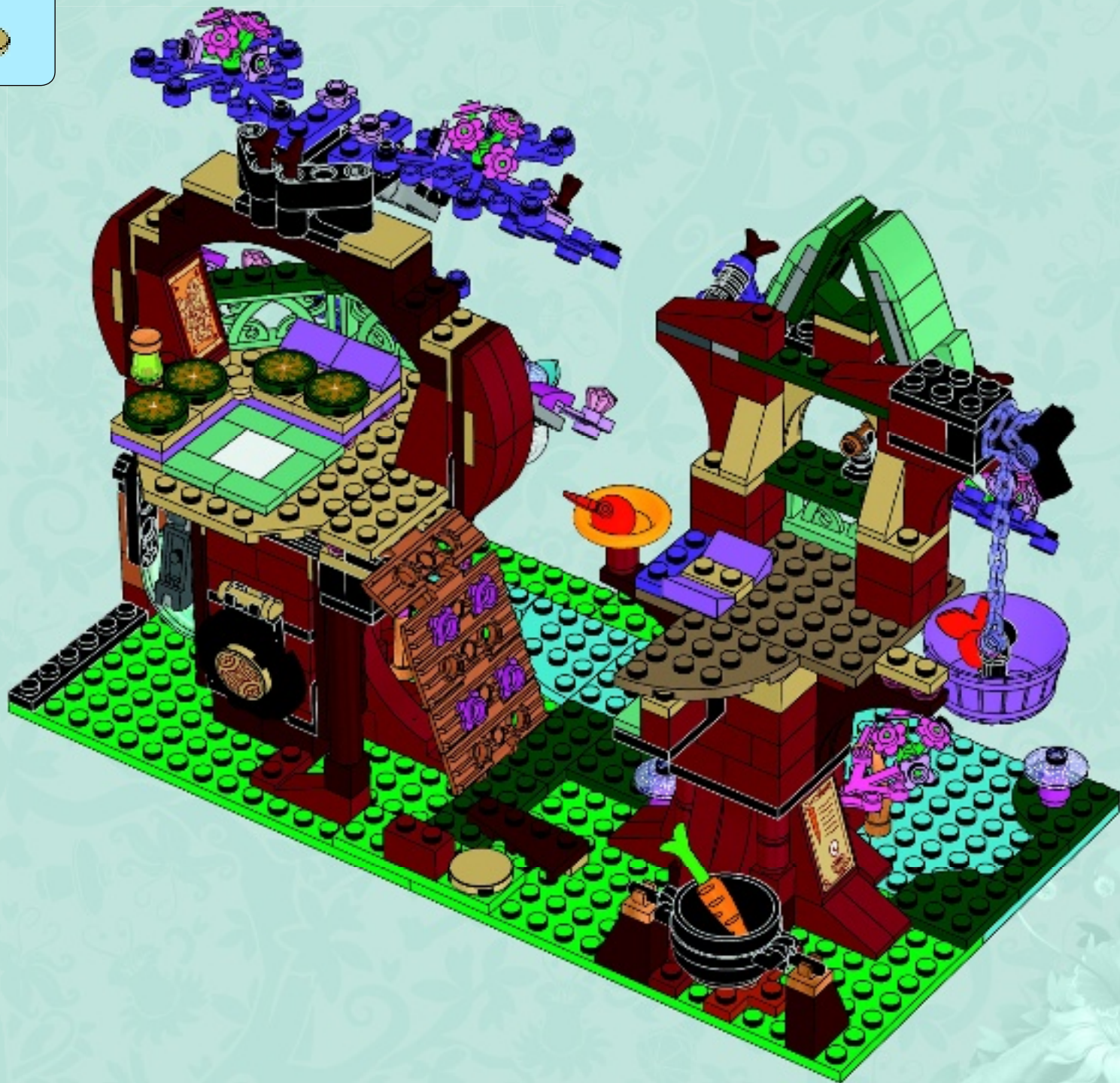
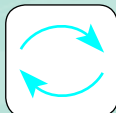

2x  1x 

55

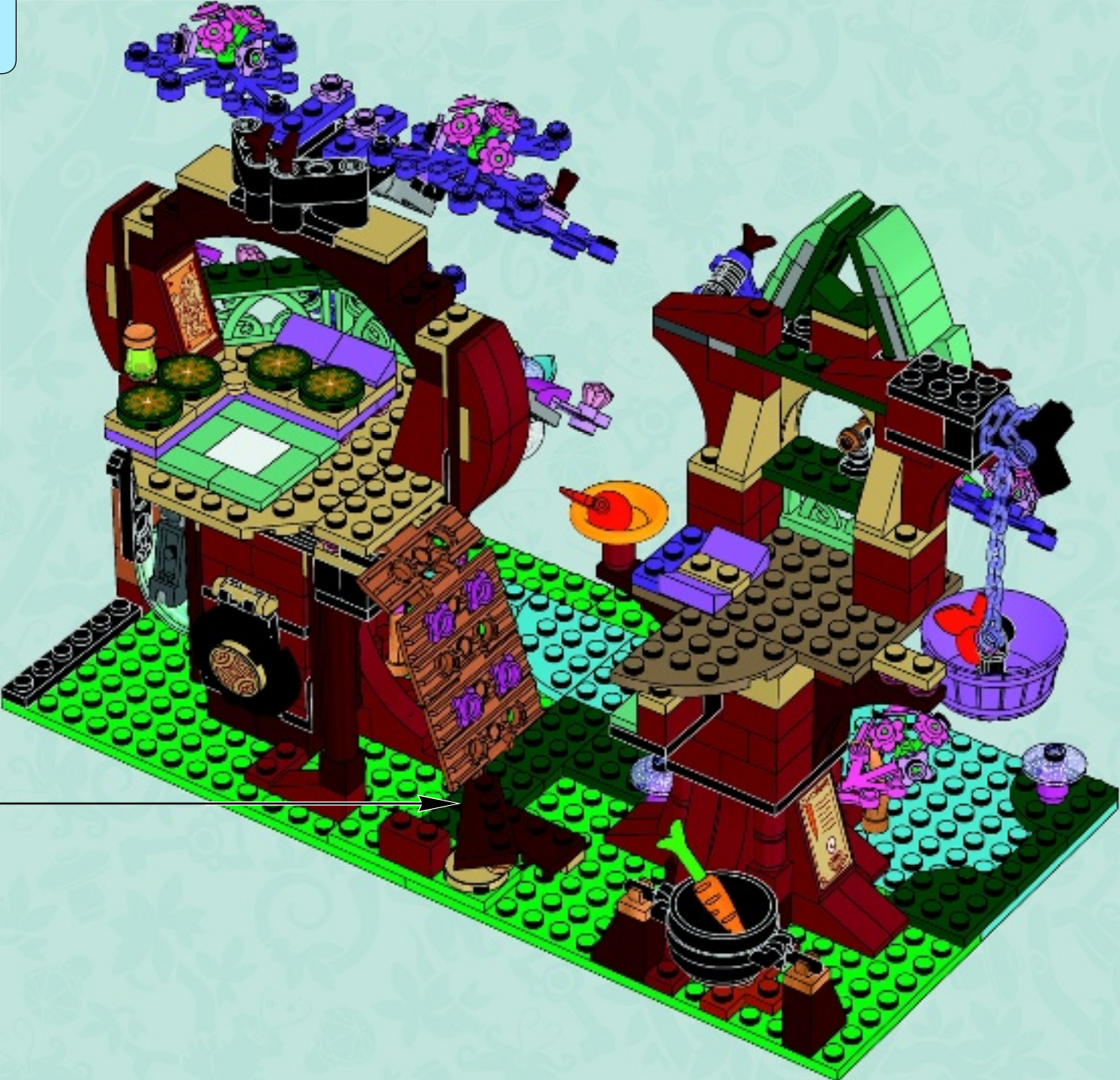



56

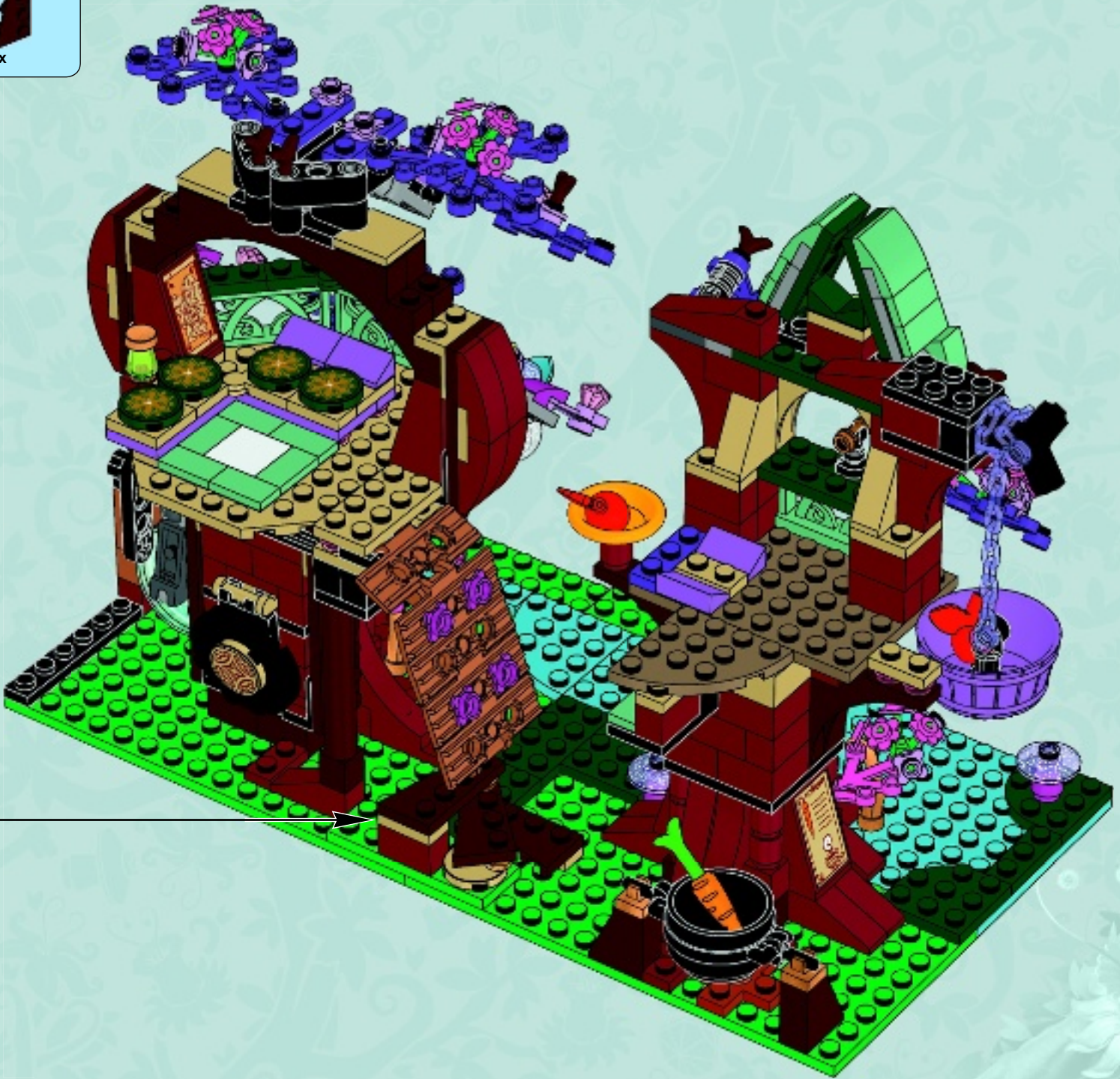

1x  3x 

57

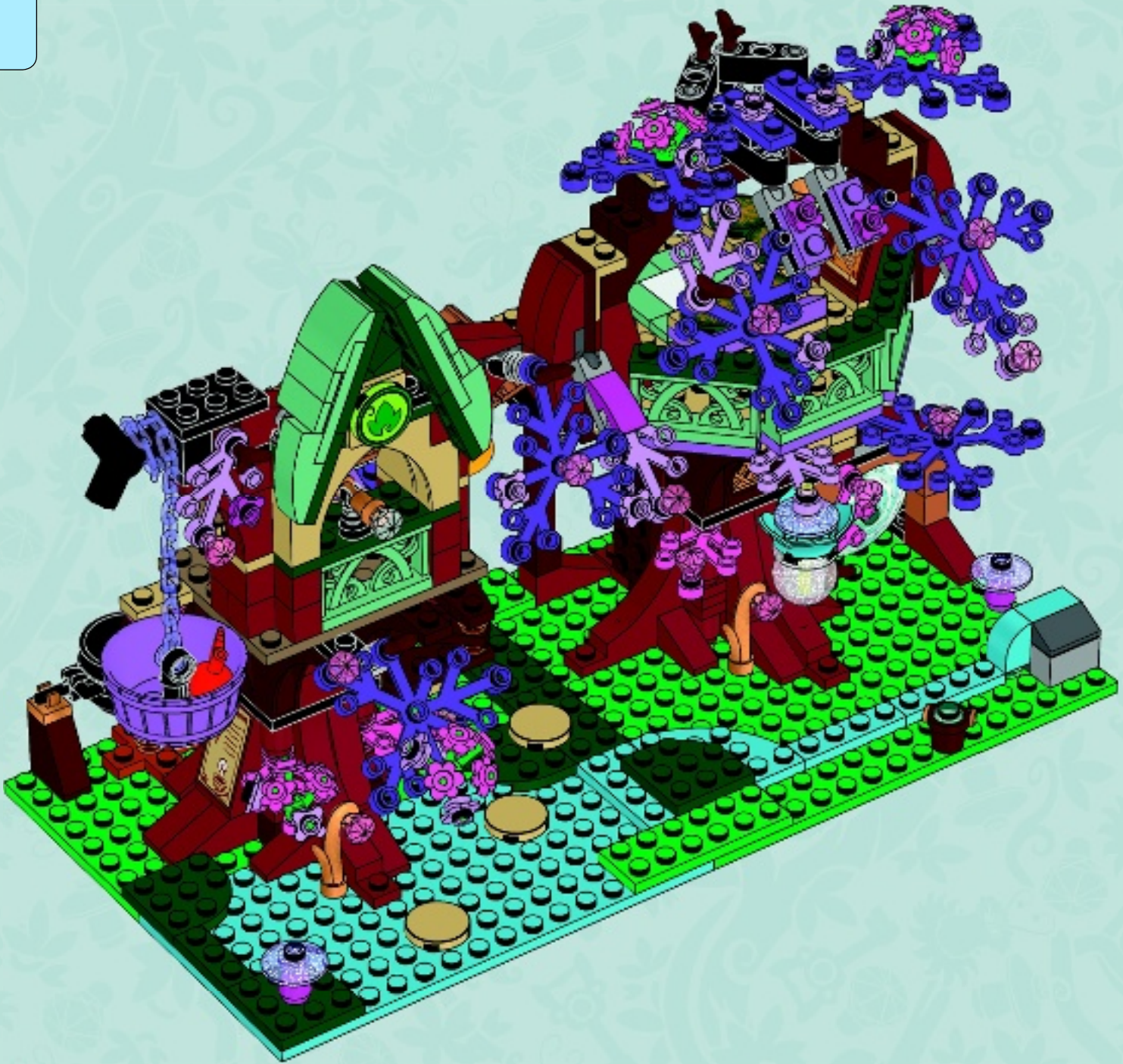





3x
614301



1x
306801



1x
4119410



1x
4114306



1x
4624086



2x
4626200



1x
4114322



2x
6058093



12x
4113917



7x
4114084



2x
4185177



4x
4114077



3x
4550324



3x
4114309



1x
4113993

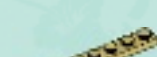

1x
4114324



5x
6117975



1x
4217562



5x
6066344

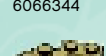

1x
6102772



2x
6054438



1x
4142865



4x
4143005



1x
4206482



2x
6039194



3x
370026



2x
302126



1x
371026



1x
302026



1x
366626



1x
6058118



1x
447726



2x
4598528



4x
4569733



4x
6000650



1x
4225201



2x
4535739



1x
4183043



2x
4258354



1x
403226



1x
6038453



1x
4525078



2x
4289538

2x
4143372



2x
4142822



2x
4120017



1x
4143466



1x
4107136



1x
4660886



1x
370826



2x
379528



4x
6097232



1x
4119479



1x
6062215



1x
4248937



1x
4646864



5x
4163917



1x
6110077



1x
4646860



1x
4124054



1x
6103249



1x
4654448



1x
6093747



14x
4599535



13x
4129917



1x
6104413



7x
6078932



3x
6003007

2x
6070763



1x
6107429



1x
6097525



4x
6093752



1x
6109383



1x
6106043



1x
6102301



1x
4251796



1x
4570451



2x
4504375



2x
6013102



3x
6013975

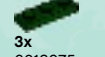

4x
4586057



4x
4245566



4x
6092771



4x
6001836



1x
6103241



2x
6102779



2x
6080431



2x
6100237



11x
4616578



2x
6100234



4x
6097680



24x
4539102



16x
4541379



6x
6052777



1x
4541528



11x
4539099

2x
4590811



Customer Service
Kundenservice
Service Consommateurs
Servicio Al Consumidor

LEGO.com/service or dial



: 00800 5346 5555
: 1-800-422-5346



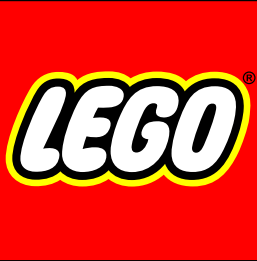

ELVES

the land of
Elvendale
completing the quest

Desertlands



The great mountain of Silad

Sparkle Rock

Leaflands

The Izdur Ocean

Blue Water Bay

Windy Beach

Leaf High Hill

Island

 LEGO.com/elves