



CREATOR

31038



LEGO.com/creator

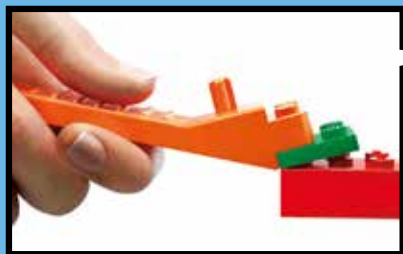

LEGO.com/brickseparator



Quick Build Construction Facile

Anfängermodelle
Construcción rápida
Construção Rápida
Egyszerűen és gyorsan -
kezdőknek
快速拼砌



Medium Build Construction moyenne

Fortgeschrittenenmodelle
Construcción
de nivel intermedio
Construção
Intermédia
Egyszerűen
és gyorsan - gyakorlóknak
中級拼砌



Advanced Build Construction avancée

Profi modelle
Construcción de nivel avanzado
Construção Avançada
Egyszerűen és gyorsan -
tapasztalt építőknek
高級拼砌



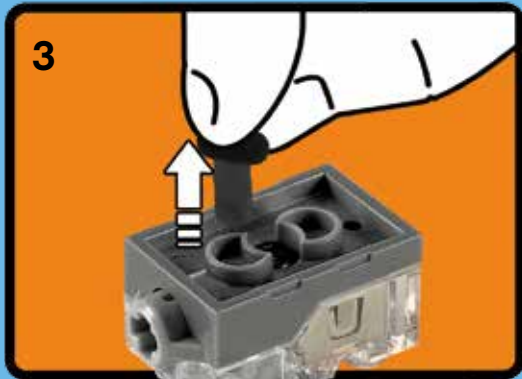

EN
Important information about batteries
Never use different types of batteries together, or a combination of old and new batteries. Always remove the batteries if the product is not to be used for a long time or if the batteries have run down. Never use damaged batteries. Only use batteries of the type recommended, or a corresponding type. Insert the batteries so that the poles are correctly positioned. Rechargeable batteries must be recharged using the correct battery charger under the supervision of an adult. You cannot recharge batteries while they are still in the product, and you must never try to do so. Never attempt to recharge non-rechargeable batteries. Never short-circuit the battery holder.

DE
Wichtige Information zu Batterien
Benutzen Sie niemals unterschiedliche Arten von Batterien oder alte und neue gleichzeitig. Nehmen Sie stets die Batterien heraus, wenn mit dem Modell längere Zeit nicht gespielt wird oder wenn die Batterien leer sind. Verwenden Sie niemals beschädigte Batterien. Verwenden Sie ausschließlich empfohlene bzw. geeignete Batterien. Achten Sie beim Einsetzen der Batterien auf die richtige Polung. Wiederaufladbare Batterien sollten mit einem geeigneten Ladegerät aufgeladen werden – unter Aufsicht eines Erwachsenen. Wiederaufladbare Batterien können und sollten niemals aufgeladen werden, während sie sich im Modell befinden. Versuchen Sie unter keinen Umständen, „normale“ Batterien wieder aufzuladen. Schließen Sie das Batteriefach niemals kurz.

FR
Informations importantes concernant les piles
Ne jamais utiliser un mélange de différents types de piles, ou de piles neuves et de piles anciennes ou déjà utilisées. Toujours retirer les piles si le produit n'est pas utilisé durant une période prolongée ou si les piles sont vides. Ne jamais utiliser de piles endommagées. Utiliser uniquement des piles du type recommandé ou d'un type équivalent. En insérant les piles, respecter scrupuleusement le sens d'orientation des pôles (+/-). Les piles rechargeables doivent être rechargées en utilisant un chargeur de piles adéquat et sous la surveillance d'un adulte. Il est impossible de recharger les piles quand elles sont installées dans le produit. Ne jamais tenter de le faire. Ne jamais essayer de recharger des piles non-rechargeables. Ne jamais court-circuiter le compartiment des piles.

IT
Importanti informazioni sulle batterie
Non usare mai contemporaneamente batterie di tipo diverso o batterie nuove e usate insieme. Rimuovere sempre le batterie qualora il prodotto non venga utilizzato per periodi prolungati, oppure se le batterie sono esauste. Non utilizzare mai batterie danneggiate. Usare esclusivamente batterie del tipo raccomandato o un equivalente. Inserire le batterie avendo cura che la loro polarità sia corretta. Le batterie ricaricabili vanno ricaricate in un caricabatterie di tipo idoneo e con la supervisione di un adulto. Non è possibile e non bisogna mai tentare di ricaricare le batterie mentre queste sono inserite nel prodotto. Non tentare mai di ricaricare batterie non ricaricabili. Non cortocircuitare mai il portabatterie.

NL
Belangrijke informatie over batterijen
Gebruik nooit verschillende soorten of een combinatie van oude en nieuwe batterijen tegelijkertijd. Verwijder de batterijen altijd als je het product lange tijd niet wilt gebruiken of als de batterijen leeg zijn. Gebruik nooit beschadigde batterijen. Gebruik uitsluitend batterijen van het aanbevolen type of een overeenkomstig type. Plaats de batterijen met de polen in de juiste richting. Opladbare batterijen moeten in een voor dit doel bestemde oplader en onder toezicht van een volwassene opnieuw worden opgeladen. Opladbare batterijen kunnen niet worden opgeladen terwijl ze zich nog in het product bevinden en dit mag ook nooit worden geprobeerd. Probeer nooit niet-opladbare batterijen opnieuw op te laden. Laat de batterijhouder nooit kortsluiten.

ES
Información importante acerca de las pilas
No use pilas de diferentes tipos ni pilas nuevas y antiguas pero alimentando el producto. Extraiga las pilas del producto si este va a permanecer sin uso durante un período prolongado de tiempo o aquellas se han agotado. No use pilas dañadas. Use sólo pilas del tipo recomendado u otro equivalente. Inserte las pilas de modo que los polos queden situados en las posiciones correctas. La carga de pilas recargables debe tener lugar empleando un cargador apropiado y bajo la supervisión de un adulto. Las pilas recargables no se pueden cargar mientras permanecen insertadas en el producto; no intente hacerlo. No trate de cargar pilas no recargables. No cortocircuite el compartimento de las pilas.

DA
Vigtige oplysninger om batterier
Brug aldrig forskellige batterityper sammen eller en kombination af gamle og nye batterier. Fjern altid batterierne, hvis produktet ikke skal bruges i lang tid, eller hvis batterierne er flade. Brug aldrig beskadigede batterier. Brug kun den anbefalede type batterier eller en tilsvarende type. Sæt batterierne i, så polerne vender den rigtige vej. Genopladelige batterier skal oplades i den rigtige batterioplader. Batterierne skal sættes i opladeren under opsyn af en voksen. Batterierne kan ikke oplades, mens de stadig sidder i produktet, og man må aldrig forsøge at gøre det. Forsøg aldrig at oplade ikke-genopladelige batterier. Kortslut aldrig batteriholderen.

FI
Tärkeää tietoa paristoista
Älä koskaan käytä erityyppisiä paristoja yhdessä. Älä myöskään käytä samassa laitteessa sekä vanhoja että uusia paristoja. Poista paristot tuotteesta aina, kun se on pitemmän aikaa käyttämättä, tai kun paristot ovat tyhjentyneet. Älä koskaan käytä viiallisia paristoja. Käytä vain tuotteesuositeltuja tai vastaavayyppisiä paristoja. Aseta paristot siten, että navat osoitavalle oikeaan suuntaan. Ladattavat paristot on ladattava oikeanlaisella laaturilla aikuisen valvonnassa. Ne on poistettava tuotteesta lataamisen ajaksi. Älä koskaan yritä ladata paristoja, joita ei ole tarkoitettu ladattaviksi. Älä koskaan aiheuta oikosulku pariston kosketinten välillä.

SV
Viktigt information om batterier
Använd aldrig olika sorters batterier samtidigt, och inte heller en kombination av gamla och nya batterier. Ta alltid ur batterierna om produkten inte ska användas under en längre tid eller om batterierna är slut. Använd aldrig skadade batterier. Använd bara batterier av den typ som rekommenderas, eller av en motsvarande typ. Sätt i batterierna så att polerna hamnar i rätt läge. Laddningsbara batterier måste laddas med rätt släts batteriladdare och under en vuxens överinseende. Du kan inte ladda batterierna medan de fortfarande sitter i produkten, och du får heller aldrig försöka göra det. Försök aldrig ladda icke laddningsbara batterier. Kortslut aldrig batteriutrymmets kontaktytor.

PT
Informação importante sobre as pilhas
Nunca use diferentes tipos de pilhas em simultâneo, ou uma combinação de pilhas usadas e novas. Retire sempre as pilhas se o produto não for usado durante muito tempo ou se as pilhas já não tiverem carga. Nunca use pilhas danificadas. Use apenas pilhas do tipo recomendado ou de um tipo correspondente. Insira as pilhas de forma a que os polos fiquem corretamente posicionados. As pilhas recarregáveis devem ser recarregadas com o carregador de pilhas correto e sob a supervisão de um adulto. Não pode recarregar as pilhas enquanto as mesmas se encontram colocadas no produto e nunca deve tentar fazê-lo. Nunca tente recarregar pilhas não recarregáveis. Nunca deixe o compartimento das pilhas entrar em curto-circuito.

EL
Σημαντικές πληροφορίες για τις μπαταρίες
Μην χρησιμοποιείτε ποτέ διαφορετικού τύπου μπαταρίες μαζί και μην συνδυάζετε παλιές και καινούργιες μπαταρίες. Αφαιρέτε πάντα τις μπαταρίες αν δεν σκοπεύετε να χρησιμοποιήσετε το προϊόν για αρκετό καιρό ή αν οι μπαταρίες έχουν αδειάσει. Ποτέ μην χρησιμοποιείτε μπαταρίες που έχουν φθορές. Χρησιμοποιείτε μόνο μπαταρίες του οριστιμένου τύπου ή κάποιοι αντίστοιχου τύπου. Τοποθετήστε τις μπαταρίες με τους πόλους στη σωστή θέση. Οι επαναφορτιζόμενες μπαταρίες πρέπει να επαναφορτίζονται χρησιμοποιώντας το σωστό φορτιστή μπαταριών υπό την επίβλεψη ενήλικα. Δεν μπορείτε να επαναφορτίσετε τις μπαταρίες όταν αυτές βρισκονται μέσα στο προϊόν και δεν πρέπει ποτέ να δοκιμάσετε κάτι τέτοιο. Μην επιχειρήσετε ποτέ να επαναφορτίσετε μη επαναφορτιζόμενες μπαταρίες. Ποτέ μην βραχυκυκλώνετε τη θήκη των μπαταριών.

JA
電池取扱に関する重要事項
異なるタイプの電池や古い電池を混ぜて使用しないでください。商品を長時間使用しないときや電池が切れるときは、電池を必ず取り外してください。不具合のある電池は、絶対に使用しないでください。推奨されているタイプまたは対応しているタイプの電池を必ず使用してください。充電器を確認して電池を正しい向きに入れてください。充電式電池は、保護者に見てもらった上で適切な充電器を使って充電してください。電池の商品中にいれたまま充電することは絶対に避けてください。充電式ではない電池は絶対に充電しないでください。電池ホルダーをショートさせないでください。

ZH
关于电池的重要信息
请勿同时使用不同类型的电池，或把新旧程度不同的电池混合使用。如果产品将有长时间不会使用，或者电池已经没电，请注意取出电池。切勿使用已破损的电池。务必仅使用推荐类型或兼容类型的电池。装入电池时请注意正负极。如果使用充电电池充电器进行充电。电池仍在产品中时不可进行充电，请勿强行尝试充电。请勿尝试给非充电电池充电。切勿对电池仓进行短路连接。

KO
배터리 사용 시 주의사항
다른 종류의 배터리를 함께 사용하거나, 새 전지와 오래된 전지를 혼용하지 마세요. 배터리가 방전되었거나 장기간 제품을 작동하지 않을 때에는 반드시 배터리를 분리하세요. 파손된 배터리는 사용하지 마세요. 레고에서 권장하는 유형의 배터리만 사용하세요. 양극과 음극의 위치를 잘 맞춰서 넣으세요. 어른의 감독에 따라 지정한 충전기에 충전지를 충전해야 합니다. 충전지를 제품에 넣은 상태로 충전하면 안 됩니다. 일반 배터리는 충전해서 사용할 수 없습니다. 배터리 홀더의 접촉부에 배터리를 정확히 끼워서 사용하세요.

RU
Необходимая информация об элементах питания
Ни в коем случае не используйте одновременно элементы питания различных типов, а также элементы питания с разным сроком годности. В обязательном порядке внимайте элементы питания из терминалов в случае, если вы не пользуетесь прибором в течение долгого времени, либо в случае, если в элементах питания закончился заряд. Ни в коем случае не используйте поврежденные элементы питания. Используйте только рекомендуемые элементы питания либо элементы питания соответствующего типа. Установите элементы питания, соблюдая указанную полярность. Аккумуляторные элементы питания должны подзарядиться в соответствующем зарядном устройстве под наблюдением взрослого. Ни в коем случае не пытайтесь подзарядить элементы питания, находящиеся в приборе. Ни в коем случае не пытайтесь подзарядить неперезаряжаемые элементы питания. Ни в коем случае не пытайтесь замкнуть полюса в устройстве для элементов питания.

PL
Ważne informacje dotyczące baterii
Nigdy nie należy stosować razem różnych rodzajów baterii ani stosować równocześnie starych i nowych baterii. Jeżeli produkt nie jest używany przez dłuższy czas lub jeżeli baterie się wyczerpały, należy wyjąć baterie. Nigdy nie należy stosować uszkodzonych baterii. Należy stosować wyłącznie zalecany rodzaj baterii lub rodzaj mi odpowiadający. Przy wkładaniu baterii należy zwrócić uwagę na właściwe położenie biegunów. Baterie akumulatorowe należy ładować w odpowiedniej ładowarce pod nadzorem osoby dorosłej. Nie można naładować baterii bez wiedzy ich z produktu i nigdy nie należy tego próbować. Nigdy nie należy próbować ładowania baterii jednorazowych. Nigdy nie należy doprowadzać do zwarcia w gnieździe baterii.

CZ
Důležité informace o bateriích
Nikdy nepoužívejte najednou různé typy baterií nebo kombinaci starých a nových baterií. Nebude-li se výrobek delší dobu používat nebo jsou-li baterie vybité, vždy je vyjměte z výrobku. Nikdy nepoužívejte poškozené baterie. Používejte pouze doporučené nebo odpovídající typy baterií. Baterie instalujte se správnou orientací pólů. Nabíjená baterie musí být nabitá ve vhodné nabíječce pod dohledem dospělé osoby. Nabíjené baterie nelze nabíjet, jsou-li umístěny ve výrobku, a nesmíte se o to ani pokoušet. Nikdy nesnažte nabíjet baterie, které nejsou nabíjené. Nikdy neskratujte kontakty v prostoru pro baterie.

SK
Dôležitá informácia o batériách
Nikdy nepoužívajte naraz odlišné typy batérií ani nekombinujte staré batérie s novymi. Batérie vždy vyberte, ak sa výrobok nebude dlhšie používať, ale ak sa batérie vybité. Používajte len odporúčané alebo zodpovedajúce typy batérií. Batérie vkladajte so správnou orientáciou pólů. Dobíjané batérie sa musia nabíjať vo vhodnom nabíjači pod dozorom dospelého osoby. Dobíjané batérie sa nesmú nabíjať, ak sú umiestnené vo výrobku, a nesmiete sa o to ani pokúšať. Nikdy nesnažte nabíjať batérie, ktoré nie sú dobíjané. Nikdy neskratujte kontakty v priestore pre batérie.

HU
Fontos tudnivalók az elemekről
Soha ne használjon különböző típusú elemeket, illetve ne használjon vegyesen új és használt elemeket. Mindig távolítsa az elemeket, ha a készülékét előre láthatóan hosszabb ideig nem fogja használni, vagy ha az elemek lemerültek. Soha ne használjon megrongálódott akkumulátorokat. Csak az ajánlott típusú, vagy annak megfelelő elemet használjon. Az elemeket polaritáshegyezze be. Az akkumulátorokat csak a megfelelő akkumulátortöltővel szabad feltölteni, egy felnőtt segítségével. Az akkumulátorokat nem lehet feltölteni, ha azok a készülékben vannak. Ezt meg sem szabad próbálni. Soha ne próbálja meg feltölteni a nem tölthető elemeket. Soha ne hozzon létre rövidzárlatot az elemartó kivezetésén.

UA
Необхідна інформація про батареї
Ніколи не використовуйте одночасно батареї різних типів або батареї з різним терміном придатності. Обов'язково вилучайте батареї з приладу, якщо довго не користуватися ним, або якщо в батарейках вже скінчився заряд. Ніколи не використовуйте пошкоджені батареї. Використовуйте батареї лише рекомендованого або відповідного типу. Вставляйте батареї, враховуючи задану полярність. Акумуляторні батареї повинні заряджатися у відповідному зарядному приладі під наглядом дорослого. В будь-якому випадку не намагайтеся підзарядити батареї, що знаходяться в приладі. В будь-якому випадку не намагайтеся підзарядити батареї, які не підлягають підзарядці. В будь-якому випадку не намагайтеся зробити коротке замикання в приладі для батареї.

HR
Važne obavijesti o bateriji
Nikada nemoj koristiti različite vrste baterija zajedno, isto tako ni kombinaciju starih i novih baterija. Uvijek izvadite baterije ako dugo nećeš koristiti proizvod ili ako su potrošene. Nikada nemoj koristiti oštećene baterije. Koristi samo preporučenu vrstu ili odgovarajuću vrstu baterija. Umetni baterije pažljivo da dobro okrenuš polove. Akumulatorske se baterije moraju puniti uz pomoć propisanog punjača i uz nadzor odrasle osobe. Baterije se ne smiju puniti dok su još u proizvodu i to nikada nemoj pokušavati. Nikada ne pokušavaj puniti baterije koje nisu predviđene za punjenje. Nikada ne izazivaj kratki spoj u držaču baterija.

SR

Важне информације о батеријама
 Никада не користите различите типове батерија заједно нити комбинацију старих и нових батерија. Увек извадите батерије уколико производ нећете дужи време користити или уколико су батерије празне. Никада не користите оштећене батерије. Употребљавајте само препоручени тип батерија или одговарајућу замену. Ставите батерије тако да су полови правилно позиционирани. Батерије на пуњење се морају пунити одговарајућим пуњачем под надзором одраслог лица. Батерије не смете да пуните нити да покушате пунити док су у производу. Никада не покушавајте да пуните батерије које не могу да се пуне. Никада не преспајате полове кућишта за батерије.

RO

Informații importante despre baterii
 Nu folosiți niciodată împreună tipuri diferite de baterii, sau o combinație de baterii vechi și noi. Îndepărtați întotdeauna bateriile dacă produsul nu este folosit timp îndelungat sau dacă bateriile s-au epuizat. Nu folosiți niciodată baterii deteriorate. Folosiți numai baterii de tipul recomandat, sau un tip corespunzător. Introduceți bateriile astfel ca polișii să fie poziționați corect. Bateriile reincărcabile trebuie reincărcate utilizând încărcătorul corect sub supravegherea unui adult. Nu puteți reincărca bateriile în timp ce acestea sunt încă în produs, și niciodată nu trebuie să încercați să faceți acest lucru. Nu încercați niciodată să reincărcați baterii nereîncărcabile. Nu scurcircuitați niciodată suportul bateriei.

LV

Svarīga informācija par baterijām
 Nekad vienlaikus nelietojiet dažādu tipu, kā arī vecas un jaunās baterijas. Vienmēr izņemiet baterijas, ja tās ir izlādējušās vai ja produkts ilgāku laiku netiek lietots. Nekad nelietojiet bojātas baterijas. Lietojiet tikai ieteicamā tipa vai atbilstošā tipa baterijas. Ievietojiet baterijas, ievērojiet pareizu polaritāti. Uzlādējamu bateriju lādēšanai izmantojiet atbilstošu uzlādētāju; uzlāde jāveic pieaugušo uzraudzībā. Baterijas nevar uzlādēt un nekad nedrīkst mēģināt uzlādēt, kamēr tās lievietotas produktā. Nemēģiniet uzlādēt baterijas, kas nav uzlādējamas. Nepieļaujiet īssavienojumu bateriju nodalījumā.

LT

Svarbi informacija apie elementus
 Vieni metu nenaudokite skirtingų elementų, taip pat su naujais elementais nenaudokite senų. Jei nenaudoosite gaminio ilgesnį laiką arba jei elementai išsekę, visomet išimkite juos iš gaminio. Niekada nenaudokite pažeistų elementų. Naudokite tik rekomenduojamo arba atitinkamo tipo elementus. Elementus dėkite atsižvelgdami į jų poliškumą. Elementus galima įkrauti tik tinkamu krovikliu ir prižiūrint saugausiesiems. Jokių būdu negalima, ir niekuomet nebandykite, įkrauti elementų neišėjus jų iš gaminio. Niekada nebandykite įkrauti vienkartinių elementų. Saugokitės, kad elementų įdėklė nesukeltumėte trumpojo jungimo.

SL

Pomembne informacije o baterijah
 Nikoli ne uporabljajte skupaj različnih baterij ali kombinacije starih in novih baterij. Vedno odstranite baterije, če izdelka dlje časa ne boste uporabljali ali če so iztrošene. Nikoli ne uporabljajte poškodovanih baterij. Uporabljajte le baterije priporočene ali ustreznega tipa. Baterije vstavite tako, da so njihovi poli pravilno obrnjeni. Akumulatorske baterije je treba polniti s pravim polnilnikom pod nadzorom odrasle osebe. Polnilniških baterij ni mogoče polniti, dokler so še v izdelku. Tega tudi ne smete poskušati. Nikoli ne poskušajte polniti baterij, ki niso akumulatorske. Pazite, da ležišče za baterije ne boste spravili v kratek stik.

BG

Важна информация за батериите
 Не използвайте различни типове батерии едновременно или комбинация от стари и нови батерии. Винаги изваждайте батериите, ако izdelka няма да се използва продължително време или ако батериите са се изтопили. Не използвайте повредени батерии. Използвайте само батерии от препоръчвания тип или съответстващ на него тип. Поставете батериите така, че полюсите да са разположени правилно. Акумулаторните батерии трябва да се зареждат с подходящо зареждащо устройство под надзора на възрастни. Батериите не могат да се зареждат, докато са поставени в изделието, така че не трябва да се опитвате да правите това. Не се опитвайте да зареждате батерии, които не са акумулаторни. Не свързвайте в късо съединение контактите на отделените за батериите.

ET

Oluline teave patareide kohta
 Ära kunagi kasuta koos erinevat tüüpi patareid, samuti vanu ja uusi patareid. Kui märguasia ei kasutata pikka aega, võta patarei sellest välja. Ära kunagi kasuta kahjustatud patareid. Kasuta ainult ettenähtud tüüpi või neile samaväärseid patareid. Pane patareid märguasia sisse nii, et pluss- ja miinusklemmi asend oleks õige. Akusid tuleb laadida ainult neile ettenähtud akulaadija abil täiskasvanu järelevalve all. Akusid ei saa laadida sel ajal, kui need on märguasia sees. Ära kunagi püüa nii teha. Ära kunagi proovi akulaadijaga laadida tavalisi patareid. Patareipesa klemmide vahel ei tohi tekkida lühis.

TR

Piller hakkında önemli bilgiler
 Hiçbir zaman değişik tipte pilleri ya da eski pilleri yeni pilleri bir arada kullanmayın. Urün uzun süre pilli kullanılmayacaksa ya da piller bitmişse, pilleri çıkarın. Hiçbir zaman zedelemiş piller kullanmayın. Sadece önerilen tipte piller ya da bunların dengi olan piller kullanın. Pilleri kutupları doğru konumda olacak şekilde yerleştirin. Bitince şarjlı pilleri doğru pil şarj alet kullanarak, bir yetşkinin denetiminde şarj edin. Şarjlı pilleri, ürünü inceleyen şarj edemezsiniz ve hiçbir zaman bunu yapmaya çalışmayın. Hiçbir zaman, şarjlı olmayan pilleri şarj etmeye çalışmayın. Hiçbir zaman pil kutusuna kısa dev yaptırmayın.



- EN Protect the environment by not disposing of this product with your household waste (2002/96/EC). Check with your local authority for recycling advice and facilities.
- DE Schützen Sie die Umwelt und entsorgen Sie dieses Produkt nicht mit Ihrem Hausmüll (2002/96/EC). Informationen zu Recycling-Möglichkeiten erhalten Sie bei den örtlichen Behörden.
- FR Protégez l'environnement : ne jetez pas ce produit avec vos autres déchets ménagers (Directive européenne 2002/96/EC). Contactez les autorités locales pour obtenir des informations sur le recyclage et connaître les points de collecte.
- IT Proteggi l'ambiente! Non smaltire questo prodotto con i rifiuti domestici (2002/96/EC). Per consulenza sul riciclaggio dei rifiuti e le strutture di riciclaggio, rivolgersi alle proprie autorità locali.
- NL Bescherm het milieu: gooi dit product niet samen met het andere huisvuil weg (2002/96/EC). Raadpleeg de plaatselijke instanties voor locaties van milieustations en advies over hergebruik.
- ES Proteja el medio ambiente no deshaciéndose de este producto junto con sus residuos domésticos (2002/96/EC). Solicite a su autoridad local consejos e información sobre instalaciones de reciclado.
- DA Beskyt miljøet! Smid ikke dette produkt ud sammen med husholdningsaffaldet (2002/96/EF). Få vejledning om genbrug og genbrugsstationer hos din kommune.
- FI Tämä tuote on hävitettävä ympäristönsuojelun vuoksi asianmukaisesti talousjätteistä erillään (2002/96/EC). Tietoa kierrätyspisteiden sijainnista saa kunnan tai kaupungin teknisestä virastosta.
- SV Skydda miljön genom att inte kasta denna produkt bland ditt hushållsavfall (2002/96/EC). Kontakta din kommun för frågor om återvinning och miljöstationer.
- PT Proteja o ambiente não eliminando este produto com o seu lixo doméstico (2002/96/CE). Consulte as autoridades locais para informação sobre reciclagem e sistemas de recolha.

- EL Προστατέψτε το περιβάλλον. Μην πετάτε αυτό το προϊόν μαζί με τα συνηθισμένα οικιακά απορρίμματα (2002/96/EC). Επικοινωνήστε με τις τοπικές αρχές σχετικά με συμβουλές και εγκαταστάσεις ανακύκλωσης.
- PL Aby chronić środowisko naturalne, nie należy wyrzucać tego produktu wraz z odpadkami z gospodarstwa domowego (2002/96/WE). W celu uzyskania wskazówek dotyczących recyklingu oraz adresów zakładów należy skontaktować się z lokalnym urzędem.
- CZ Nevyhazujte tento produkt do domácího odpadu, chrňte životní prostředí (2002/96/EC). Zjistěte si prosím u místních úřadů možnosti recyklace a dostupná zařízení.
- SK Nevyhadzujte tento produkt do domáceho odpadu, chrňte životné prostredie (2002/96/EC). Zistite si prosím na miestnych úradoch možnosti recyklácie a dostupné zariadenia.
- HU Környezetét óvja, ha ettől a terméktől nem a háztartási hulladékmal együtt váltak meg (2002/96/EC). Érdeklődjék a lakóhelyéhez közel eső hatóságánál az újrahaznosítás módjáról és lehetőségeiről.
- SL Zaščitite okolje! Okolje varujte tako, da tega izdelka ne zavržete skupaj z gospodinjiskimi odpadki (v skladu z direktivo 2002/96/ES). Pri krajevni upravi preverite, kakšne možnosti in kateri obrati za recikliranje obstajajo v vaši okolici.
- LV Lai saudzētu vidi, neizmetiet šo izstrādājumu kopā ar sadzīves atkritumiem (2002/96/EC). Vērsieties vietējās varas iestādēs, lai noskaidrotu, kur un kā tas nododams pārstrādei.
- ET Keskkonda saate kaitsta nii, et ei kõrvalda seda toodet koos olmejäätmetega (2002/96/EÜ). Nõuandeta toote taaskasutusse võtmise ja ümbertöötlemispunktide kohta saate asjaomasealt kohalikult asutuseilt.
- LT Saugokite aplinką – nemeskite šio produkto kartu su buitinėmis atliekomis (2002/96/EB). Atsižvelkite į savo vietos valdžios rekomendacijas dėl pakartotinio panaudojimo ir sąlygas.



1x



1x

1

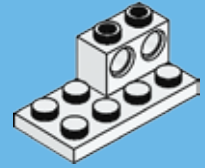

1x

2

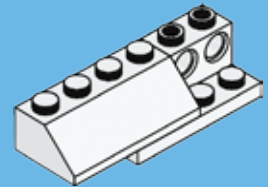

3

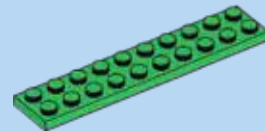

1x

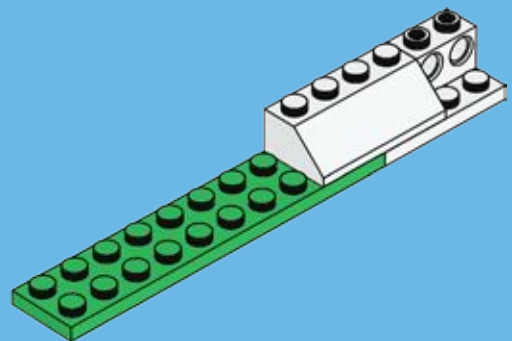

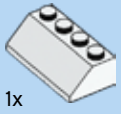

1x



2x

4

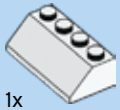
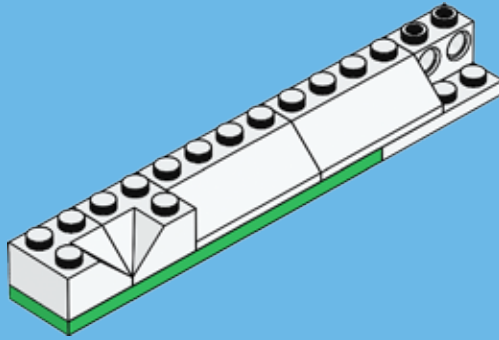

1x

5

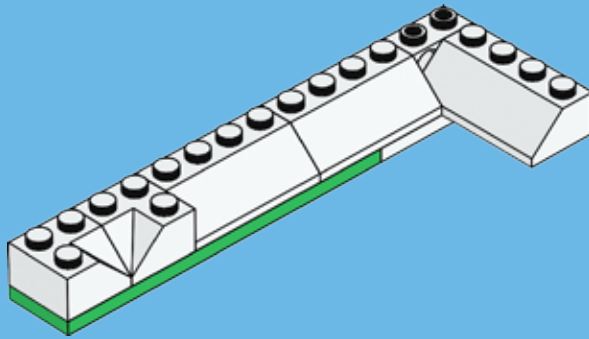

1x

6

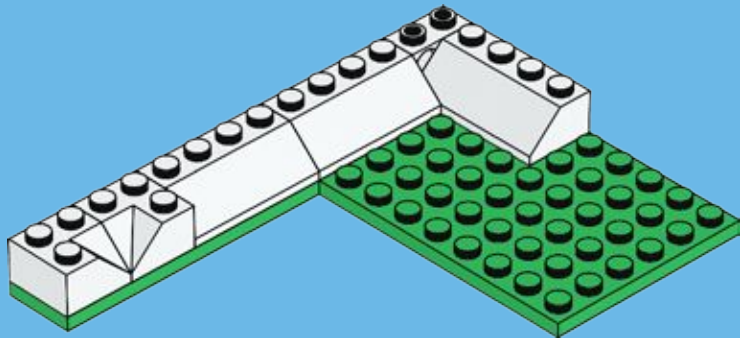



1x



1x



1x



7

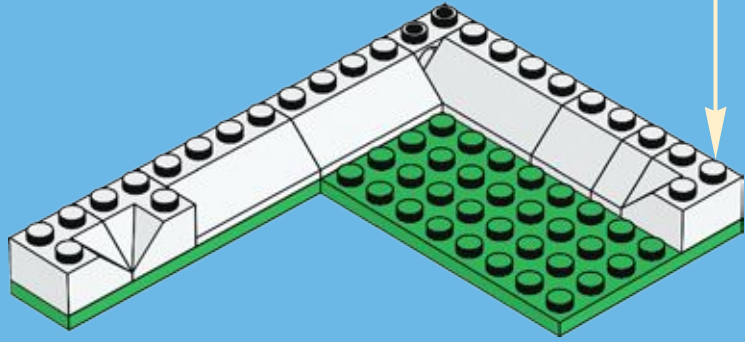

1x

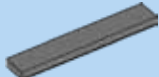

3x

8

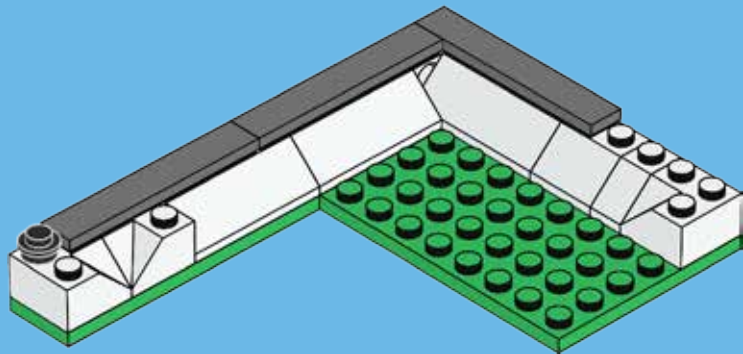

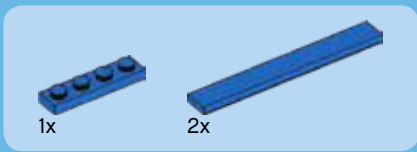

9

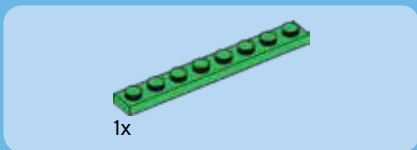
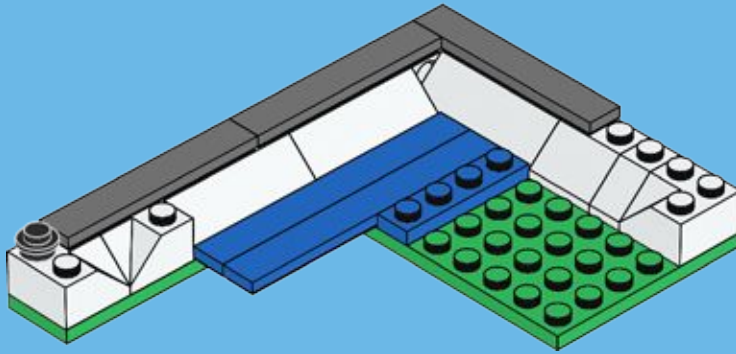

10

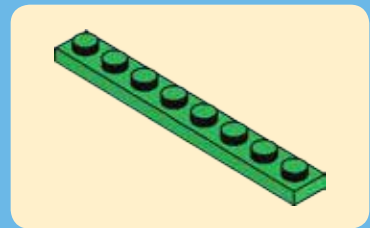
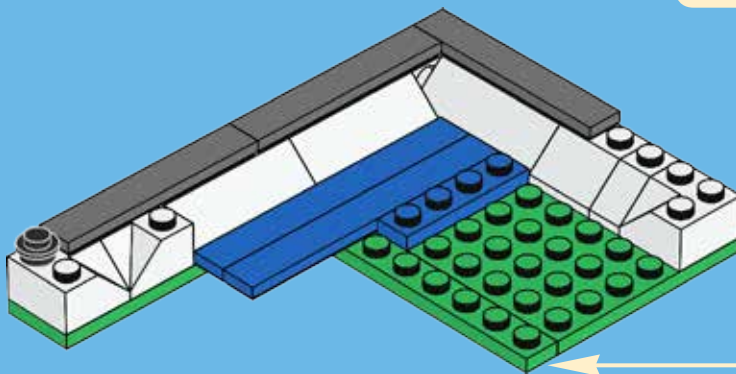

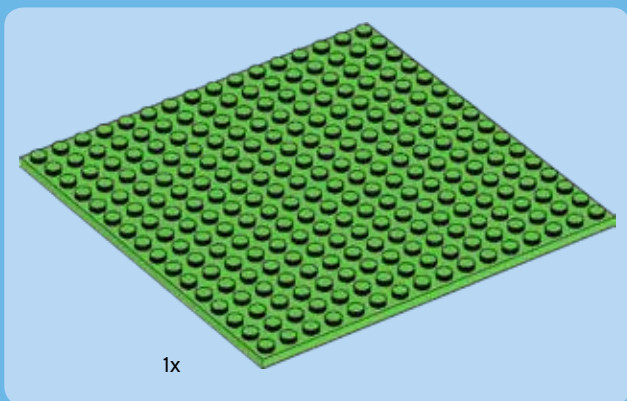

11

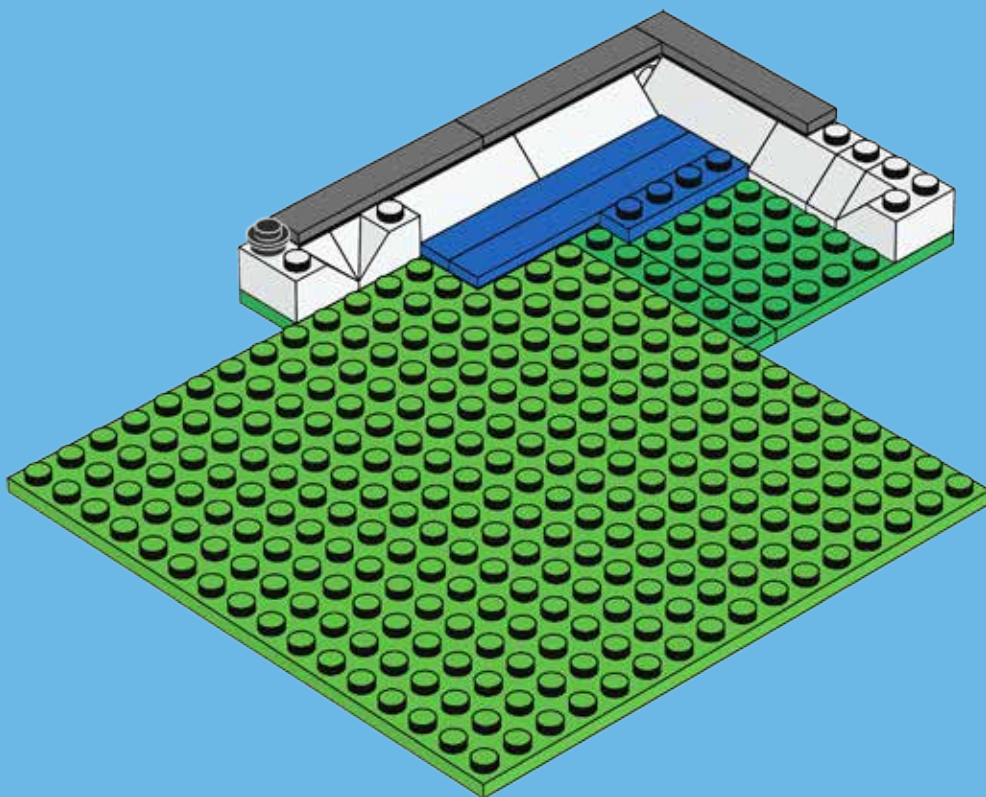

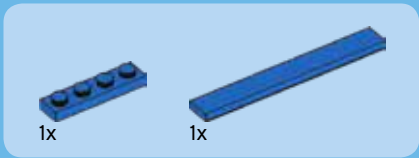

12

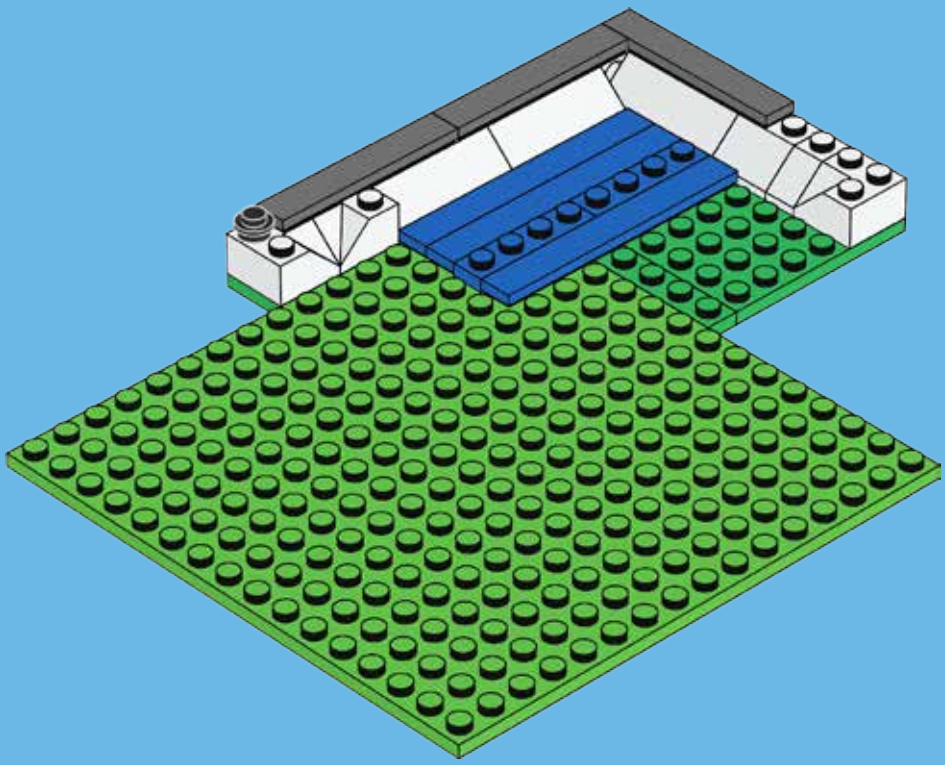

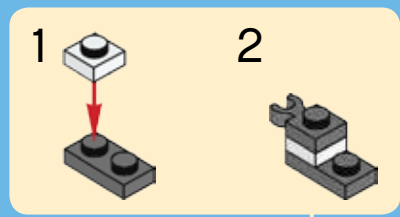
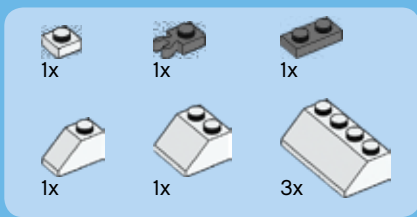

13

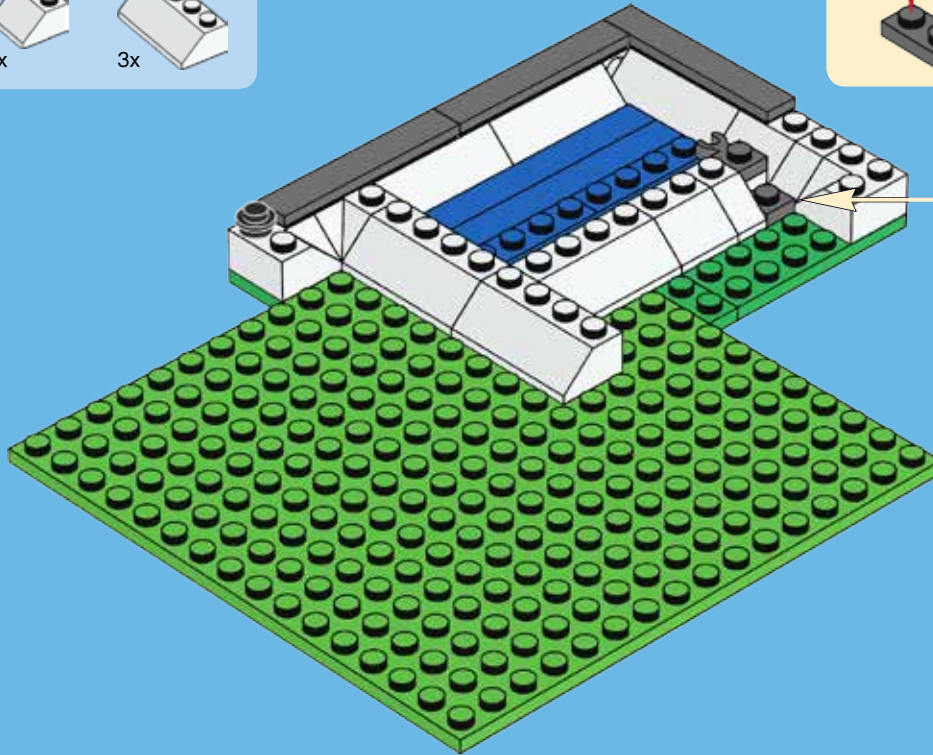

14

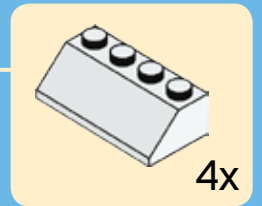
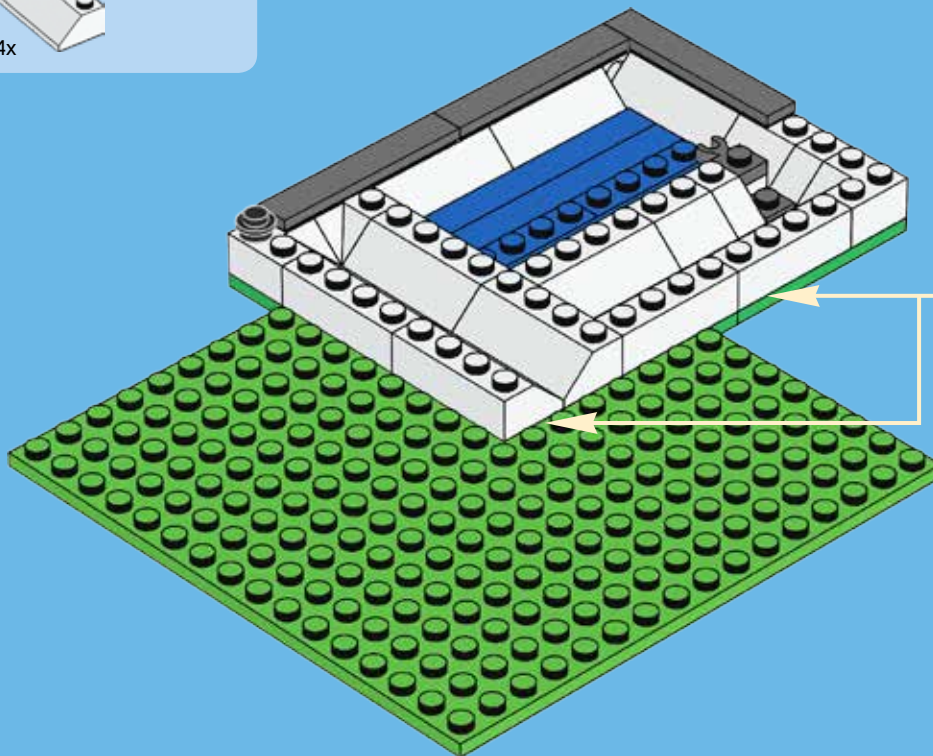

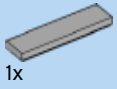

1x



1x



2x

15

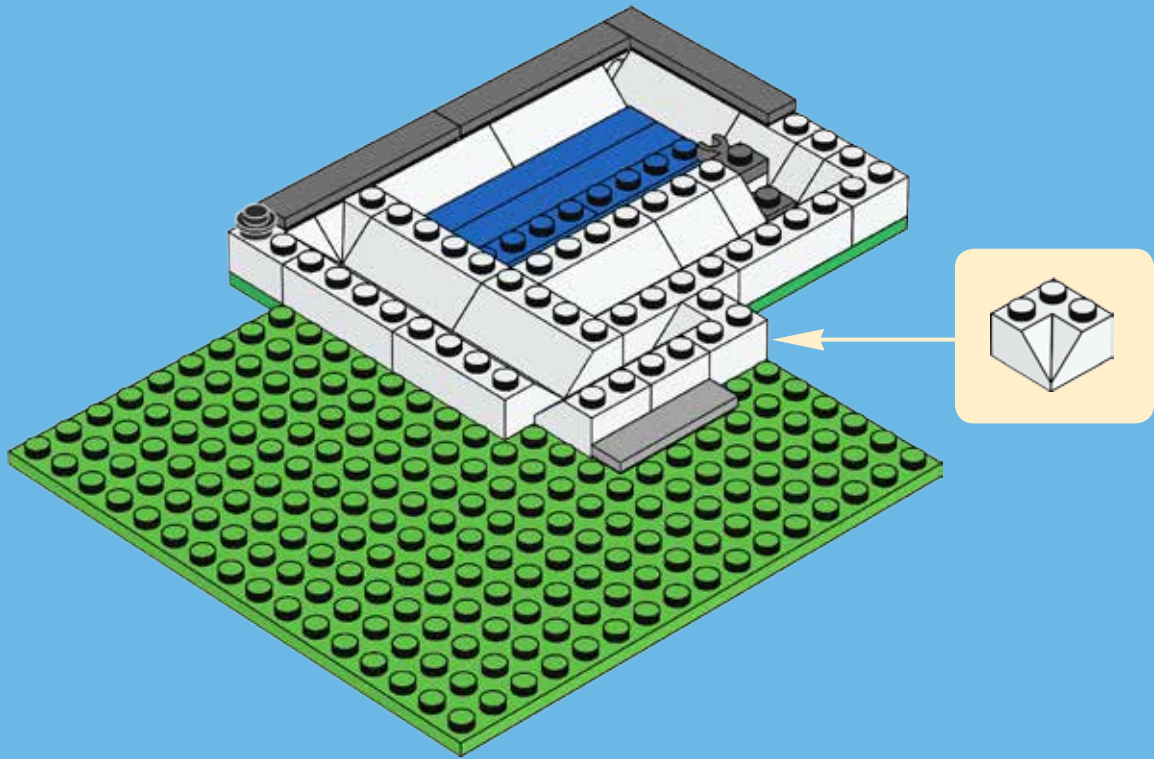

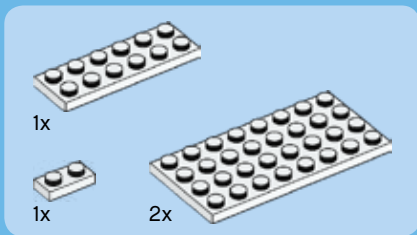

16

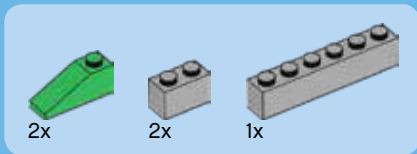
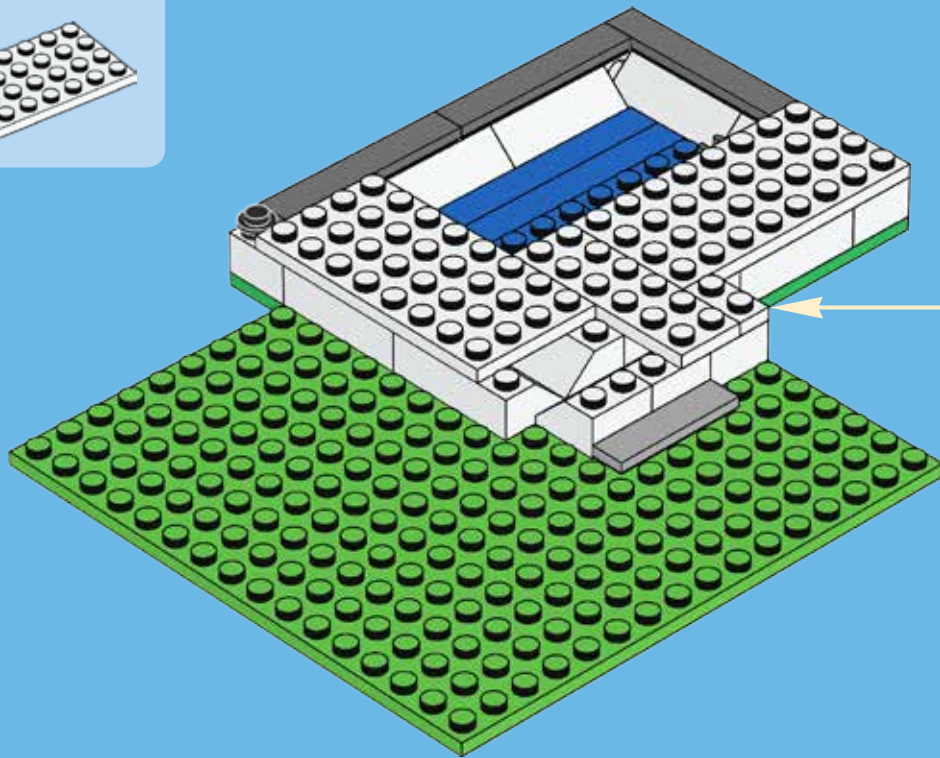

17

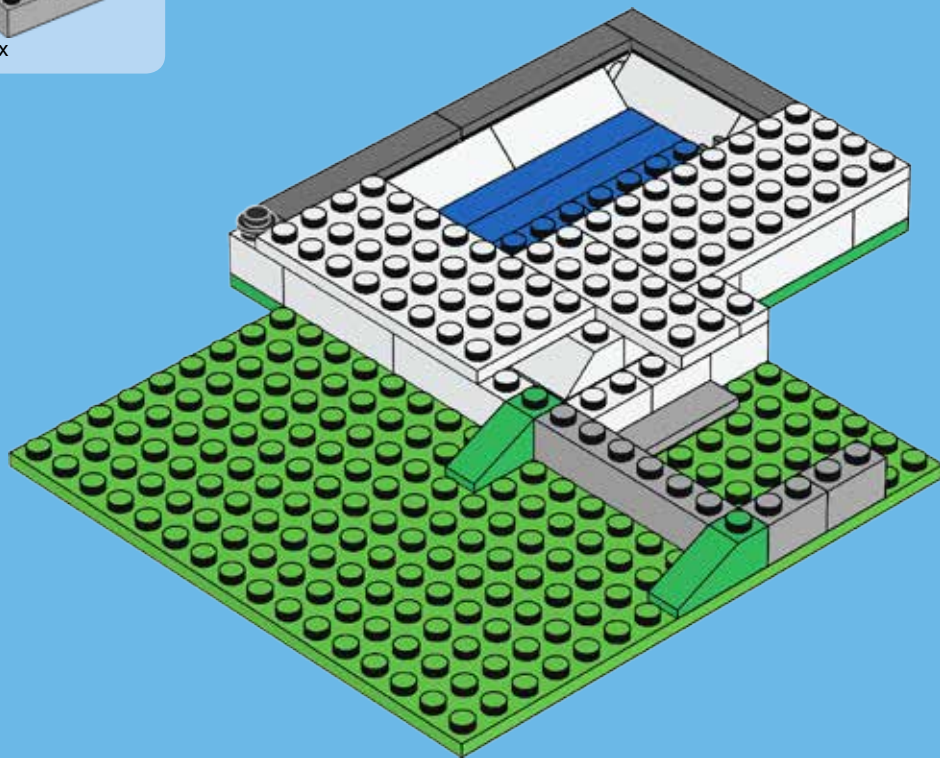



1x



2x



1x

18

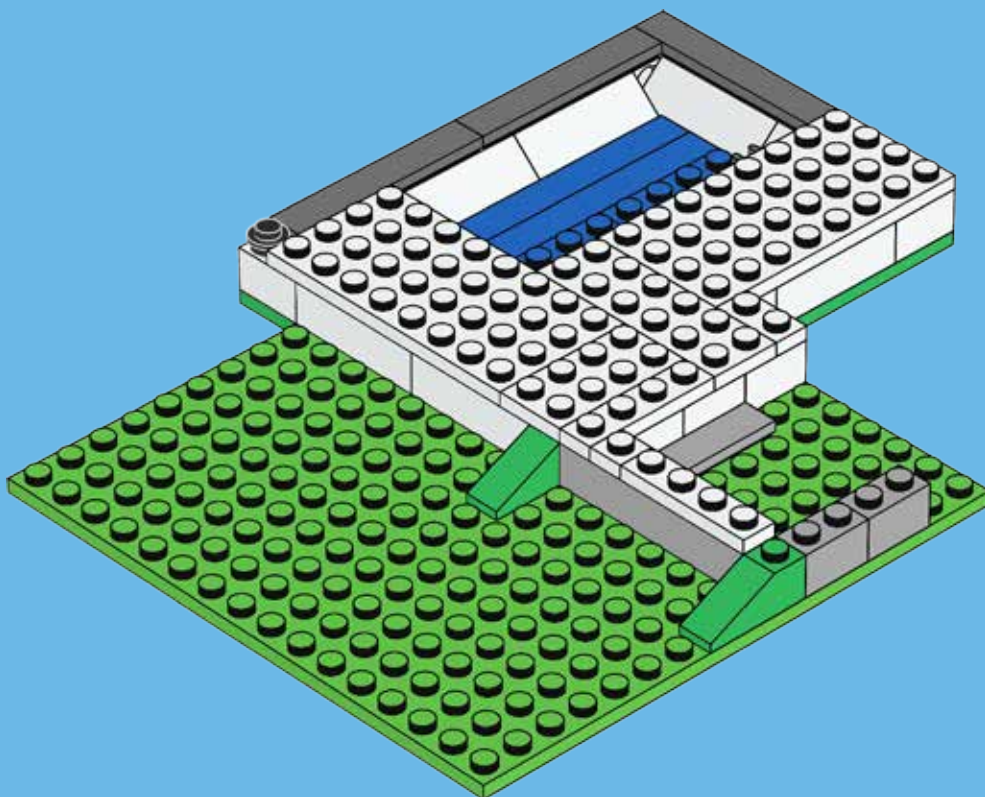

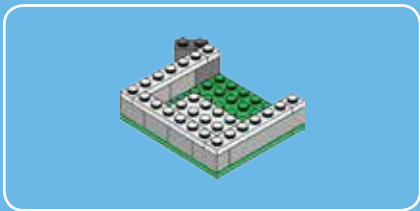

1

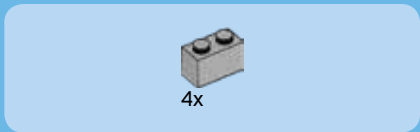
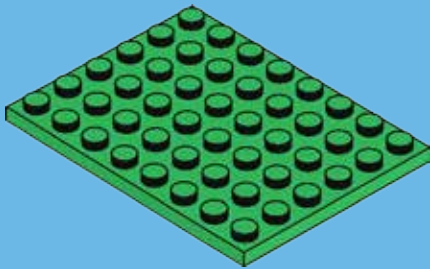

2

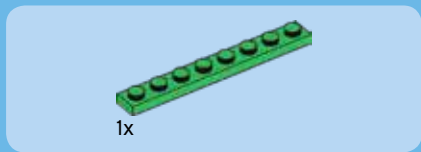
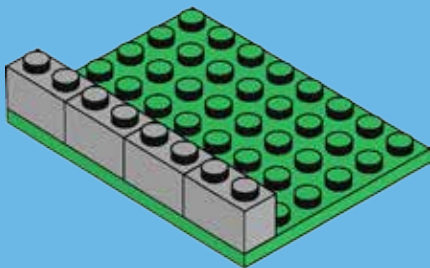

3

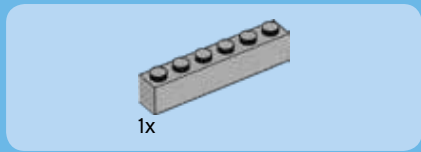
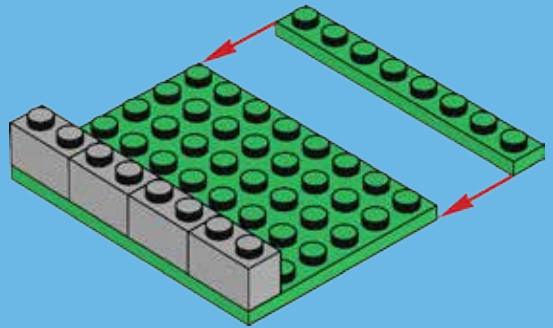

4

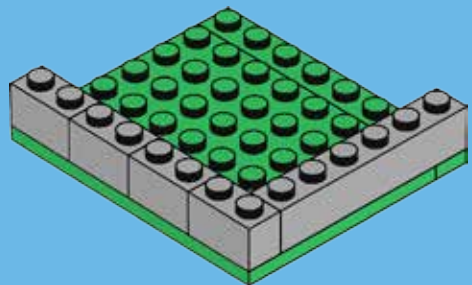



2x



1x



1x

5

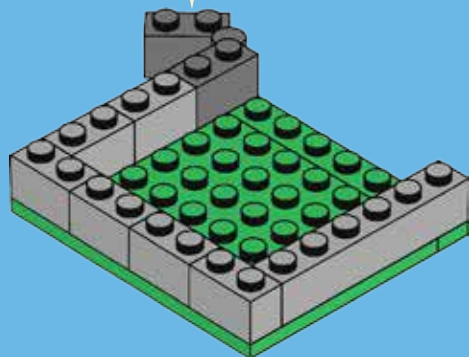
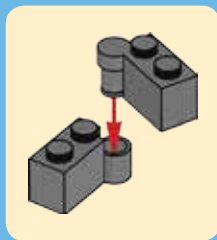

2x



3x

6

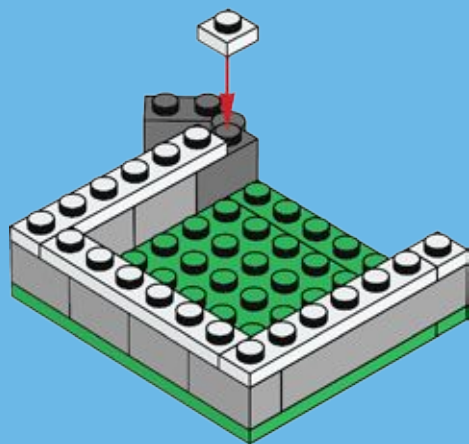



1x



2x

7

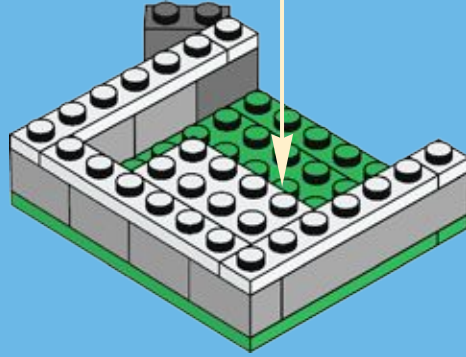
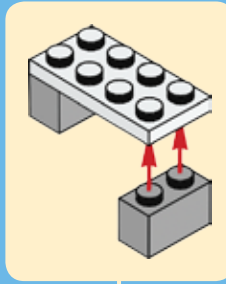

19

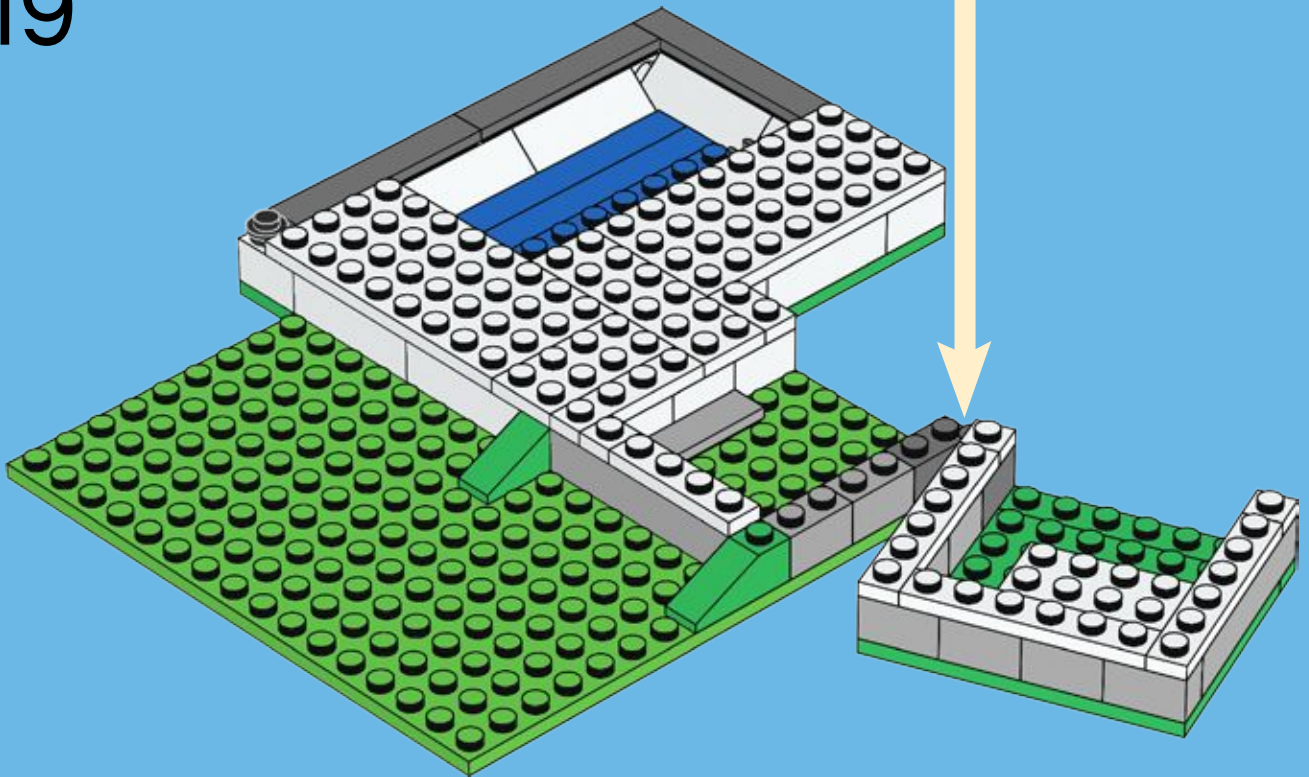

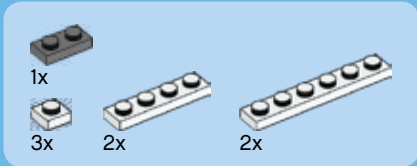

20

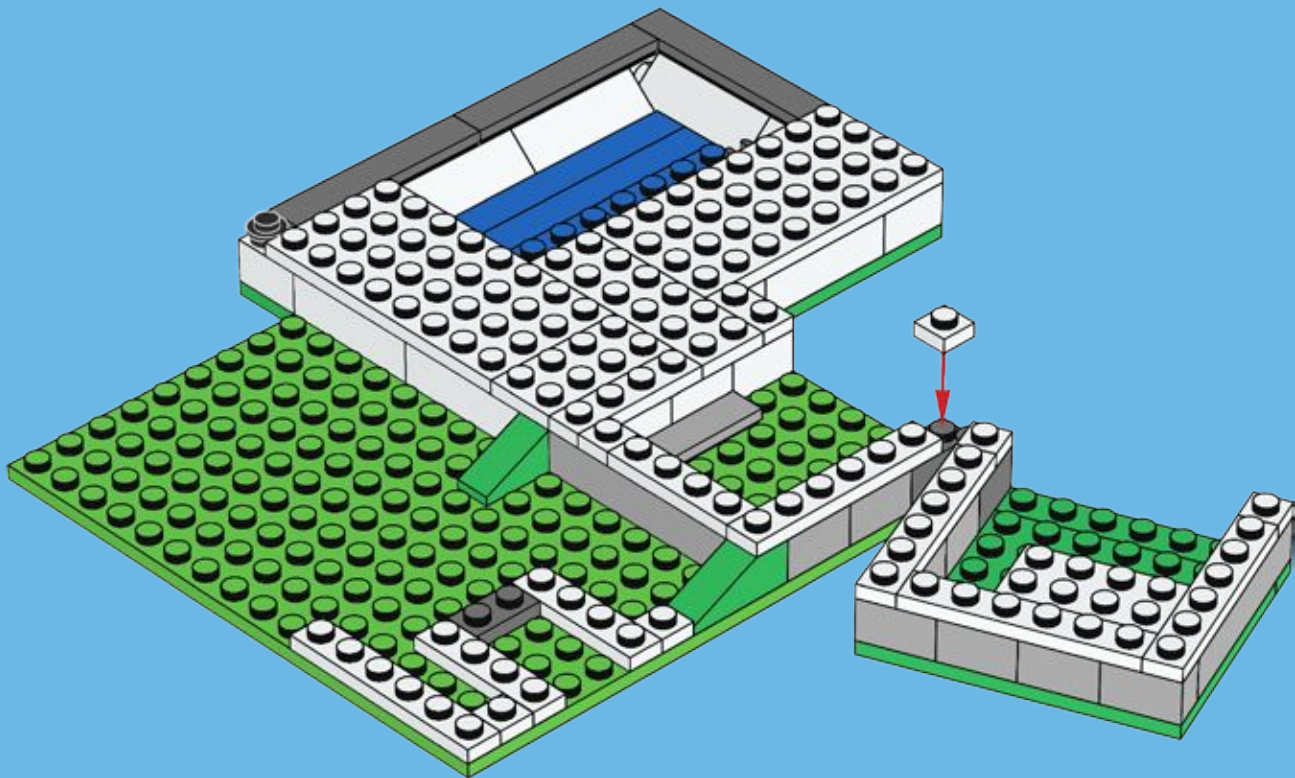

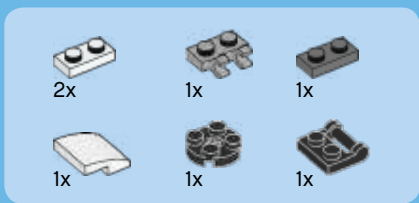

21

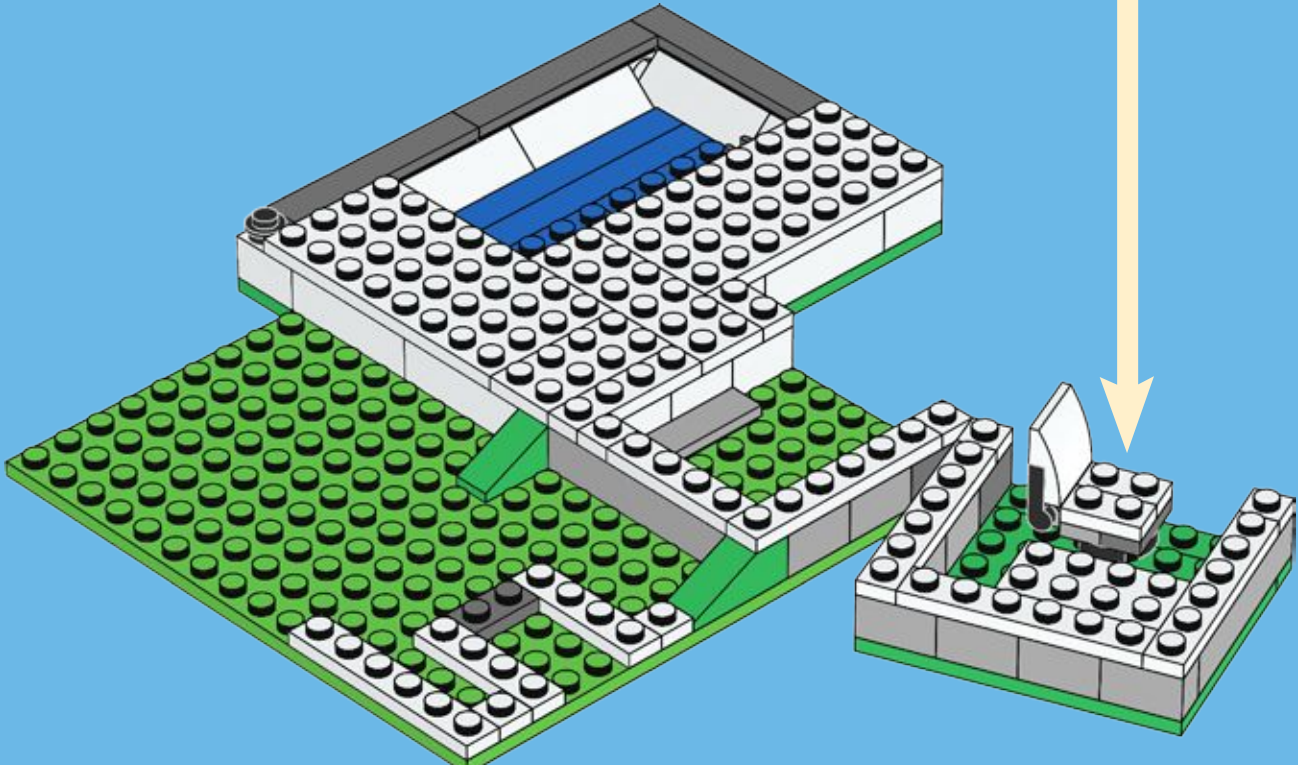
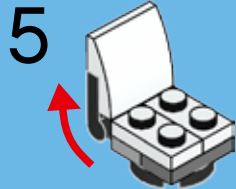
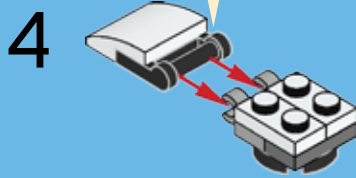
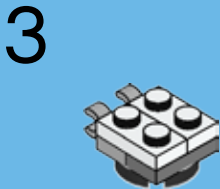
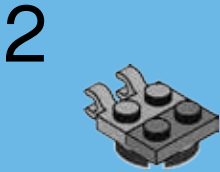



2x



2x



2x

22

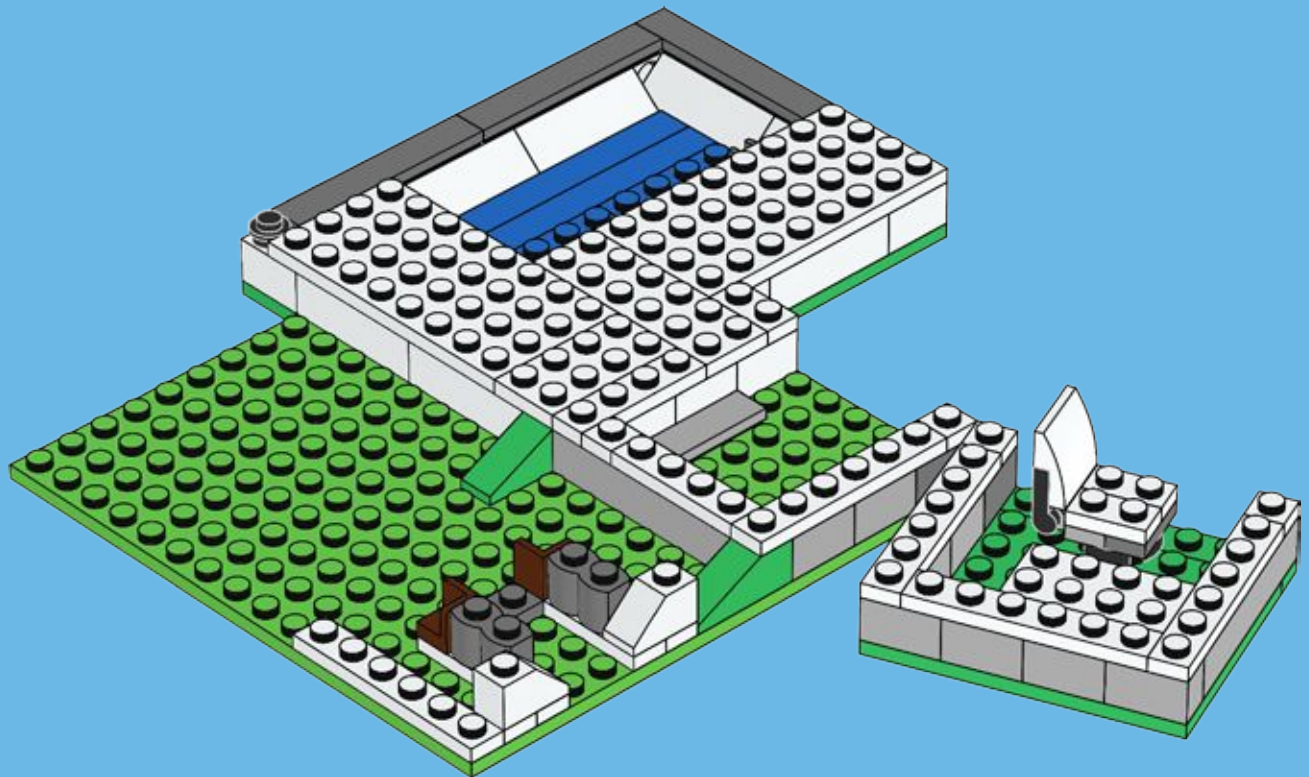



23

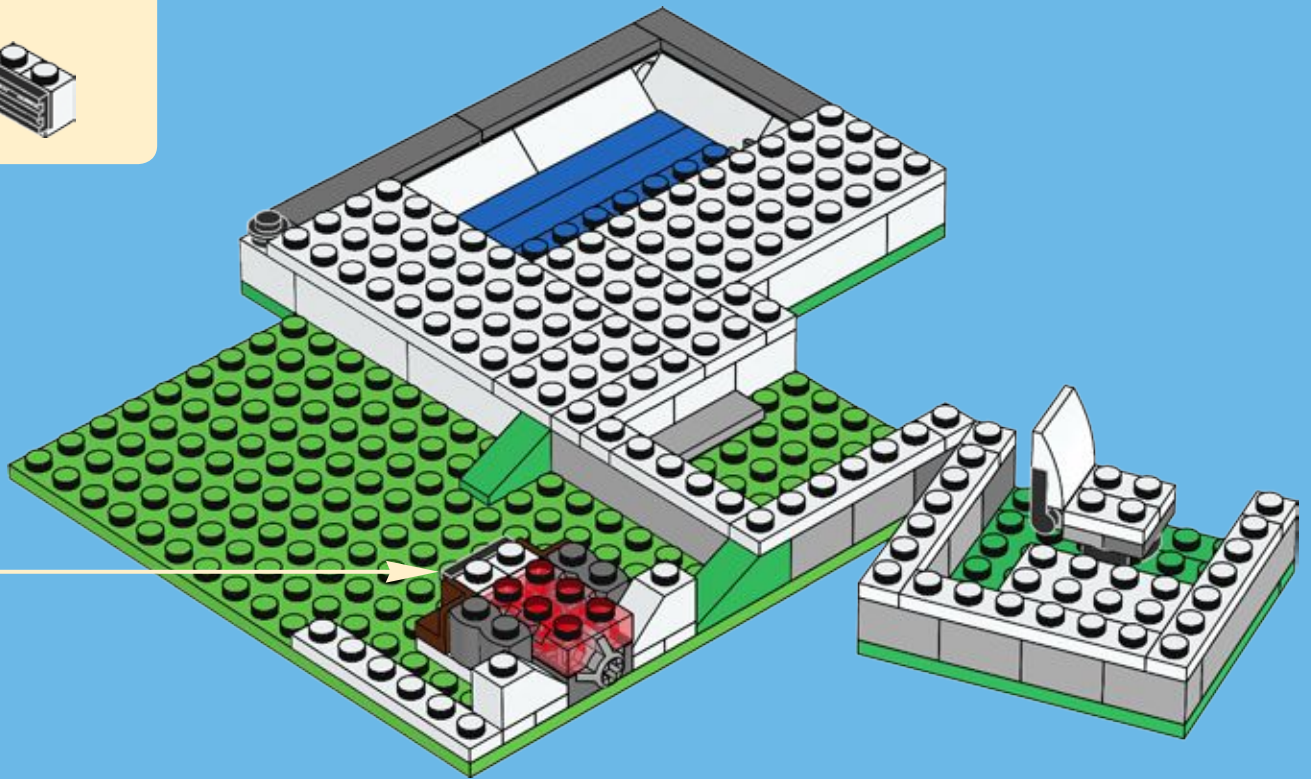
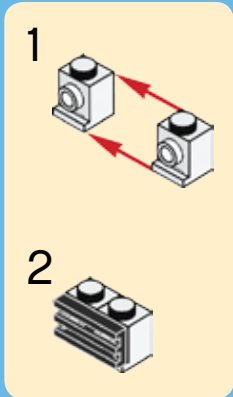



1x



2x



2x



2x

24

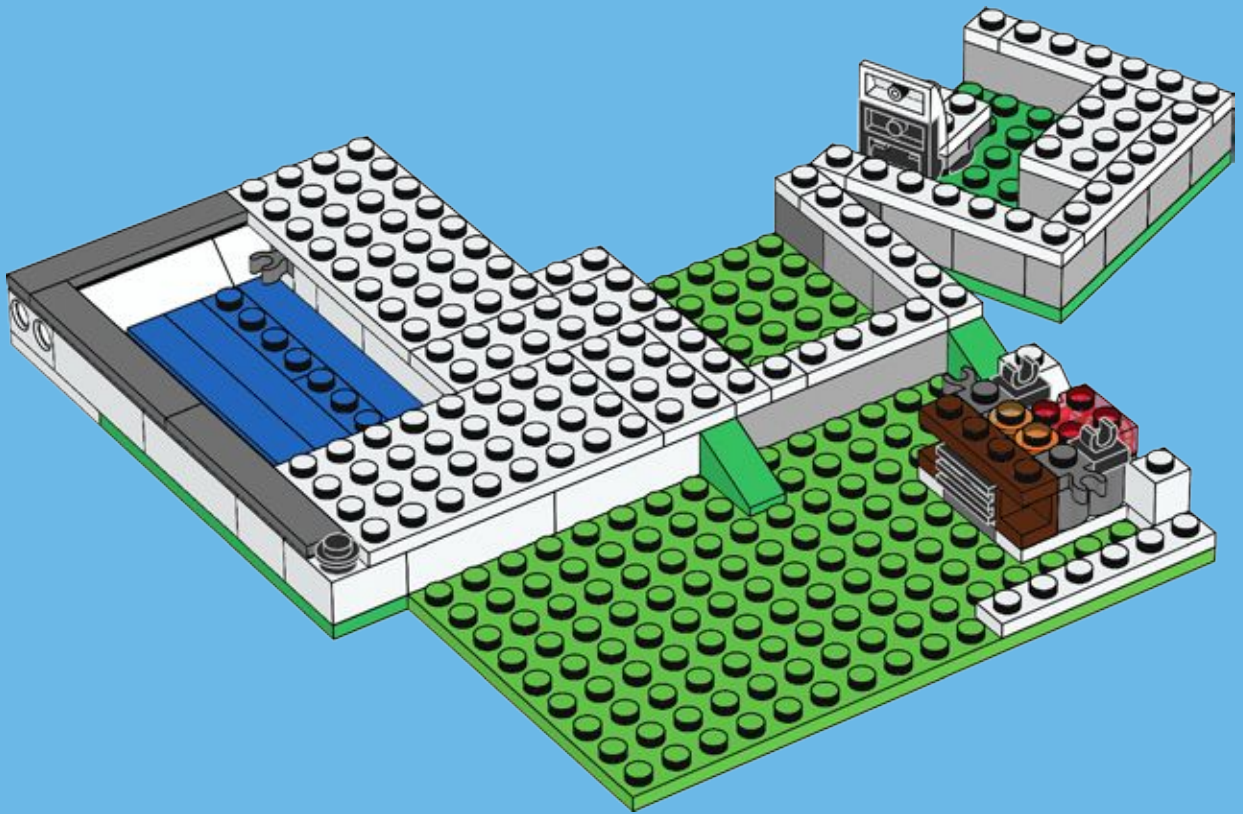



1x



2x



1x

25

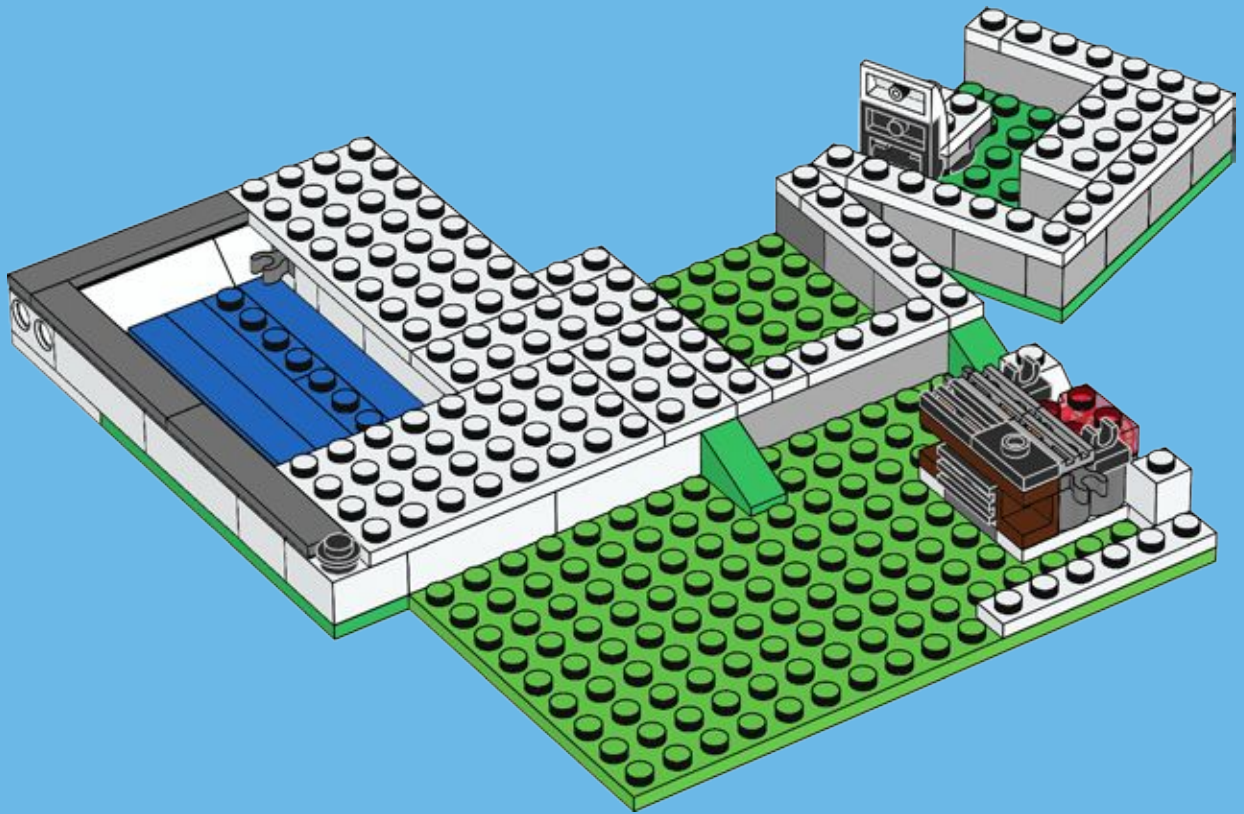



2x



2x

26

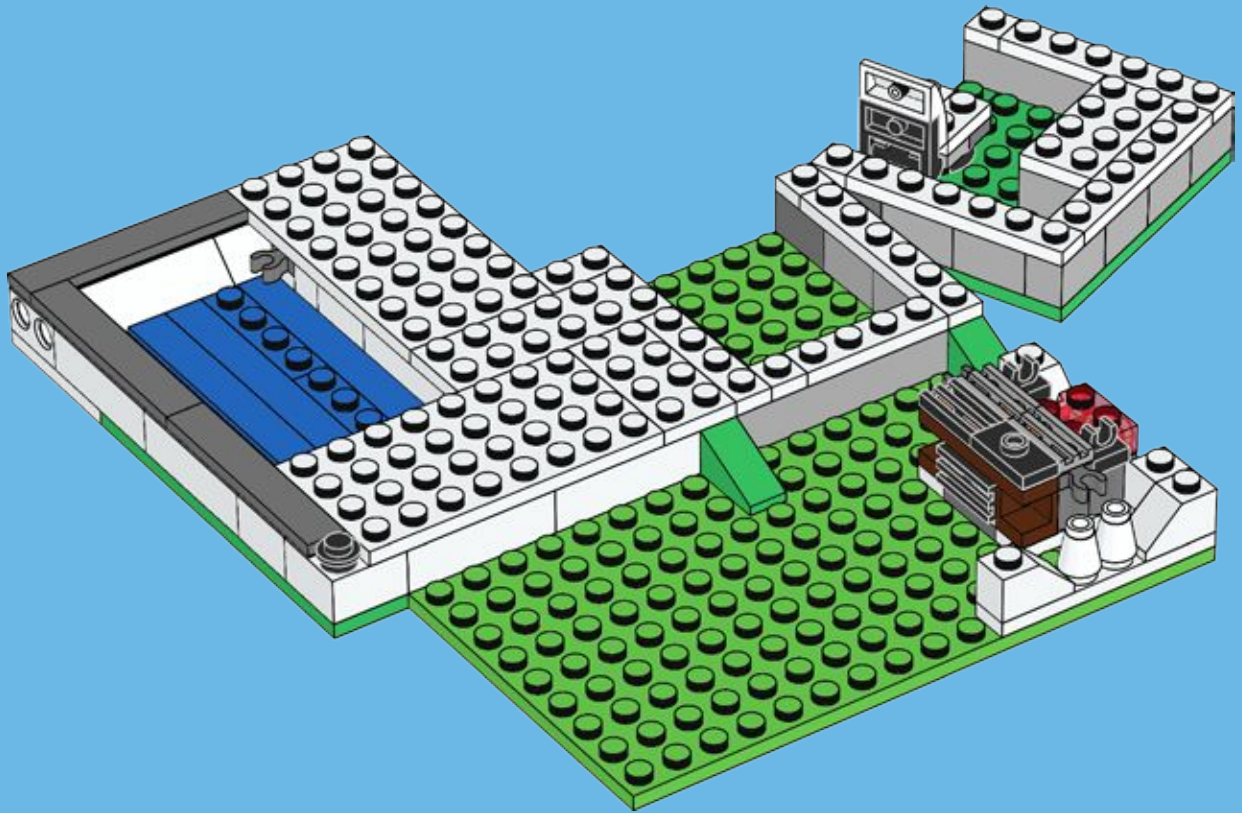



2x

27

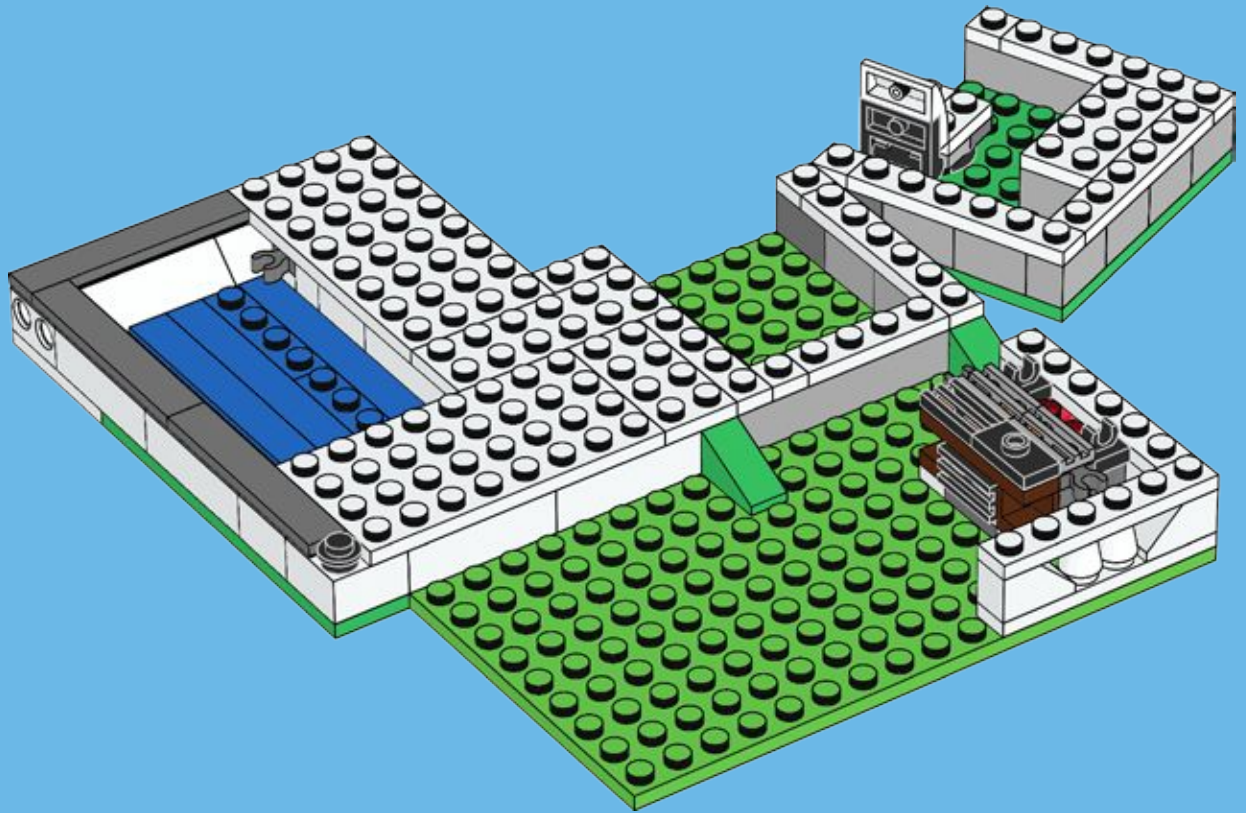



2x

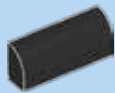

1x

28

1

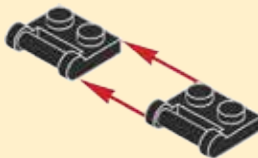

2

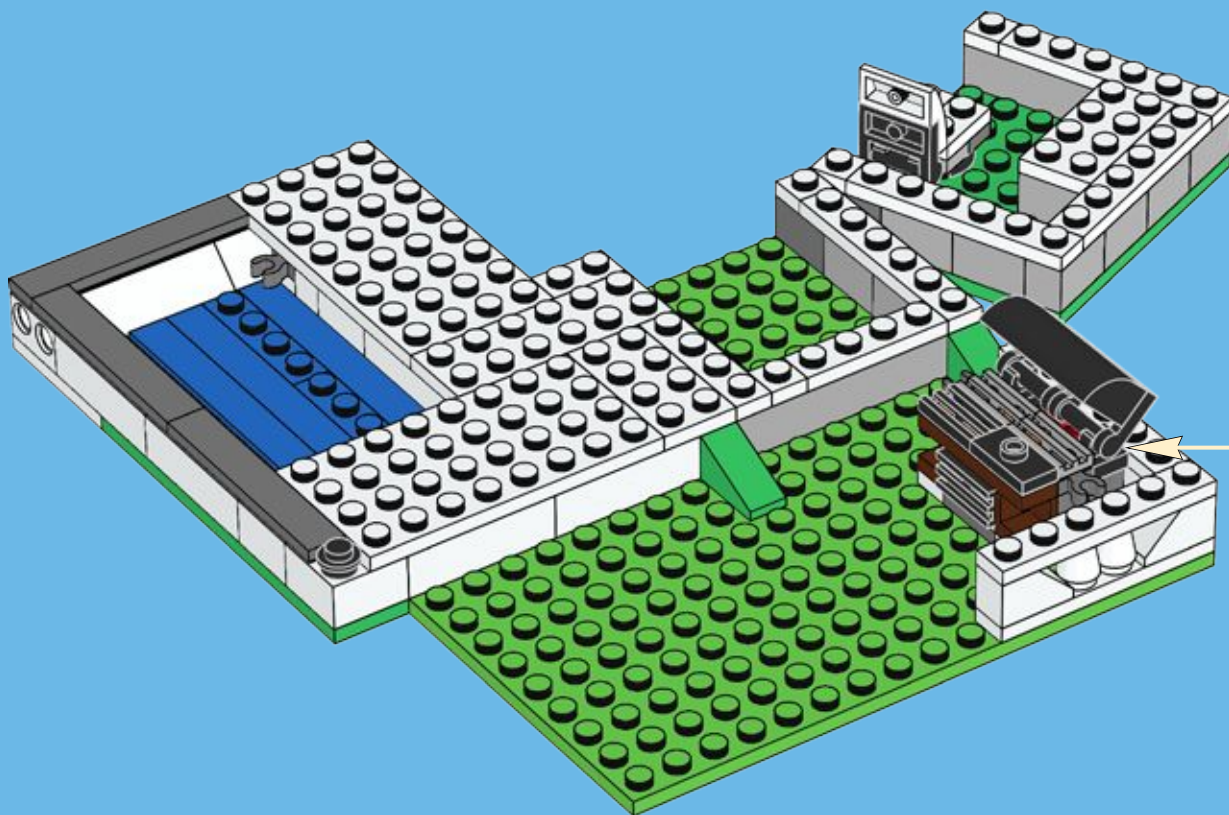
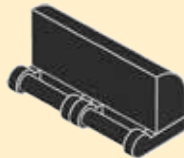

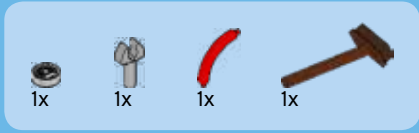

29

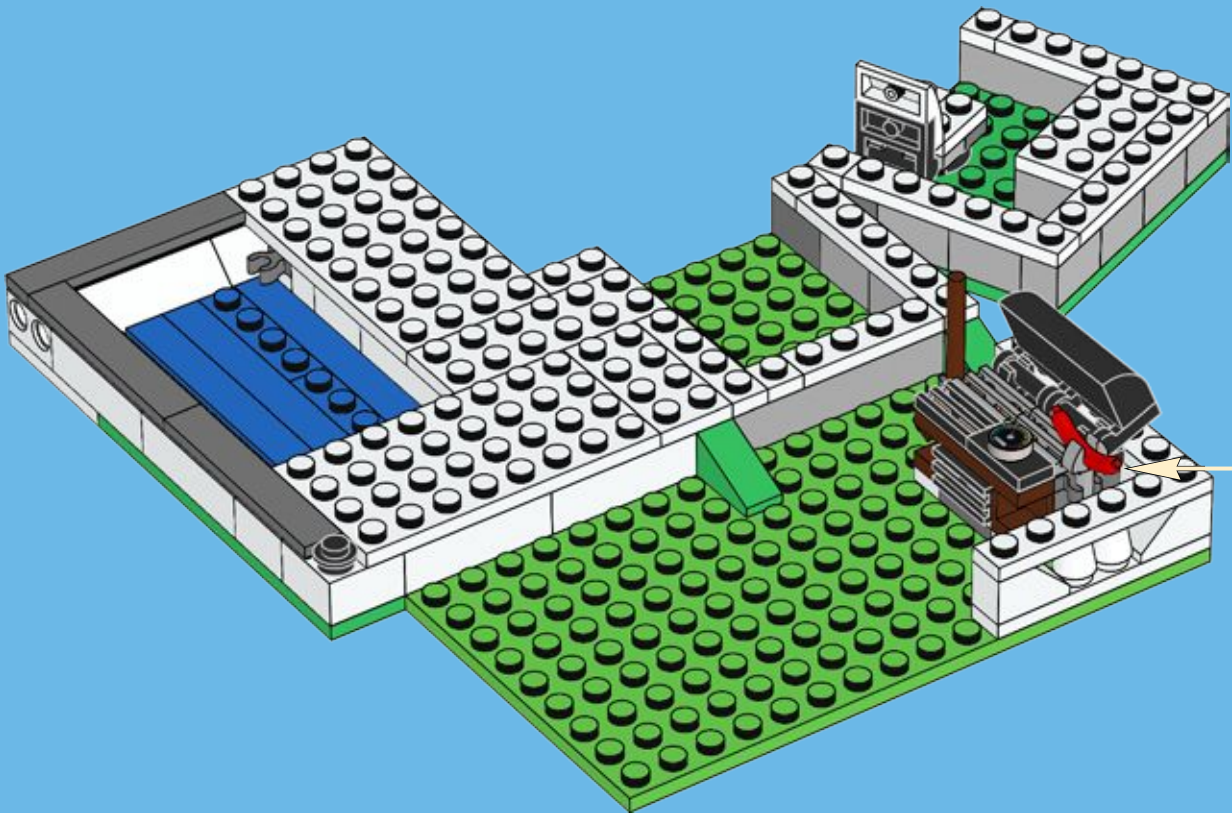



1x



1x



1x

30

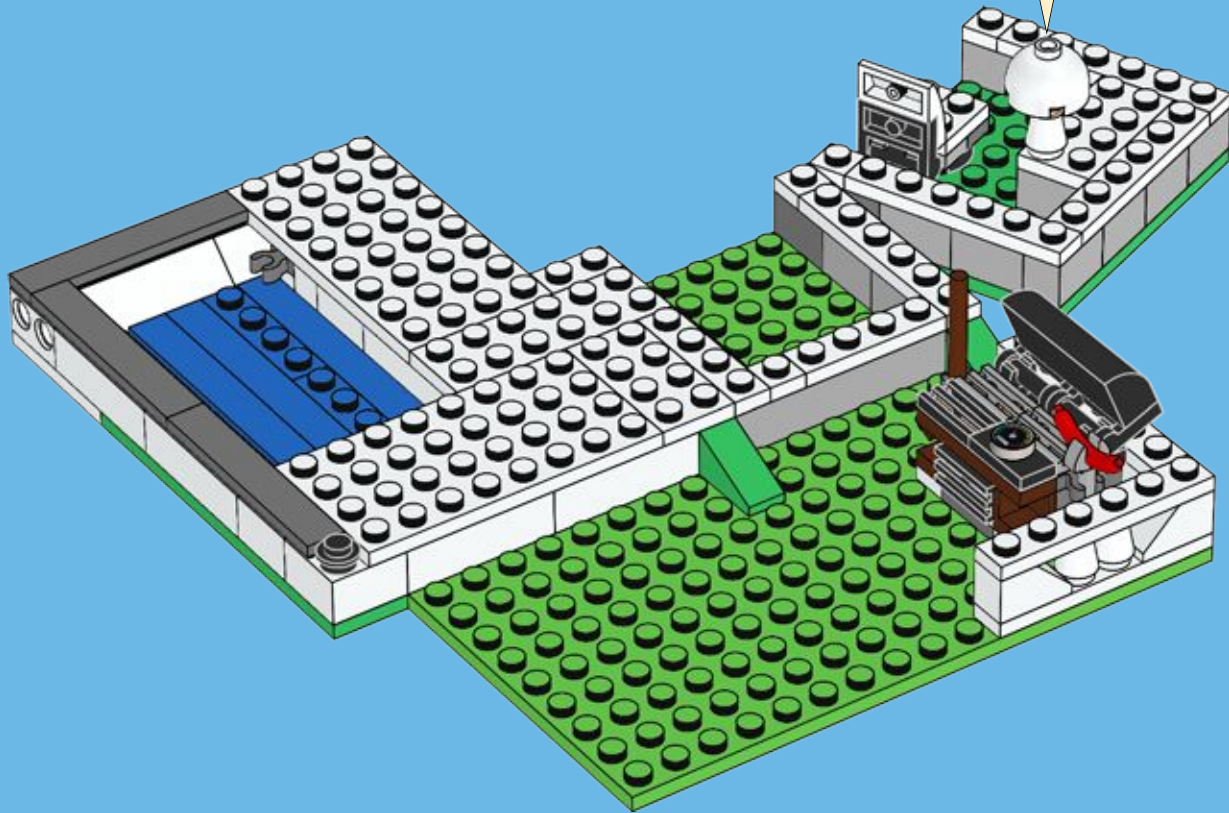

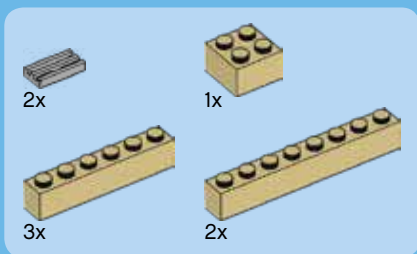

31

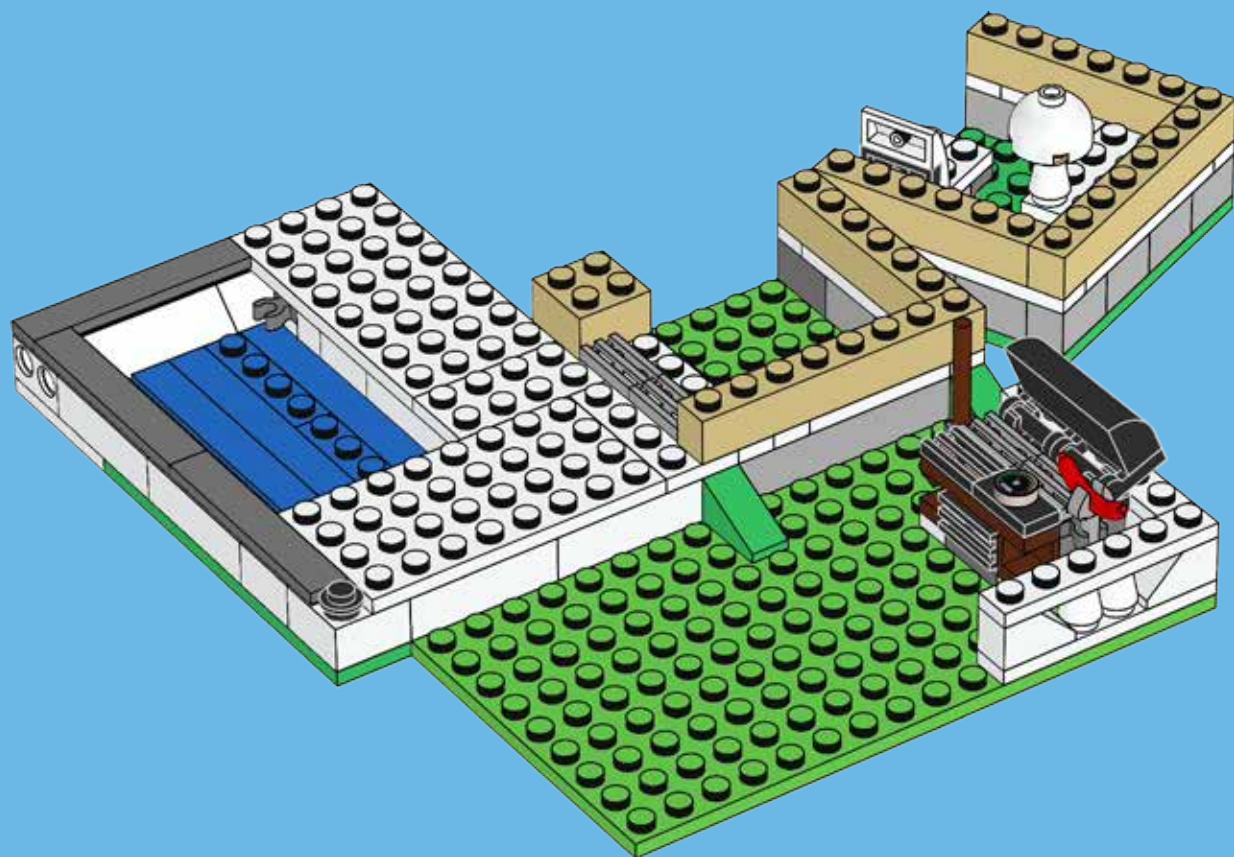

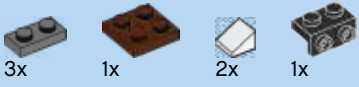

32

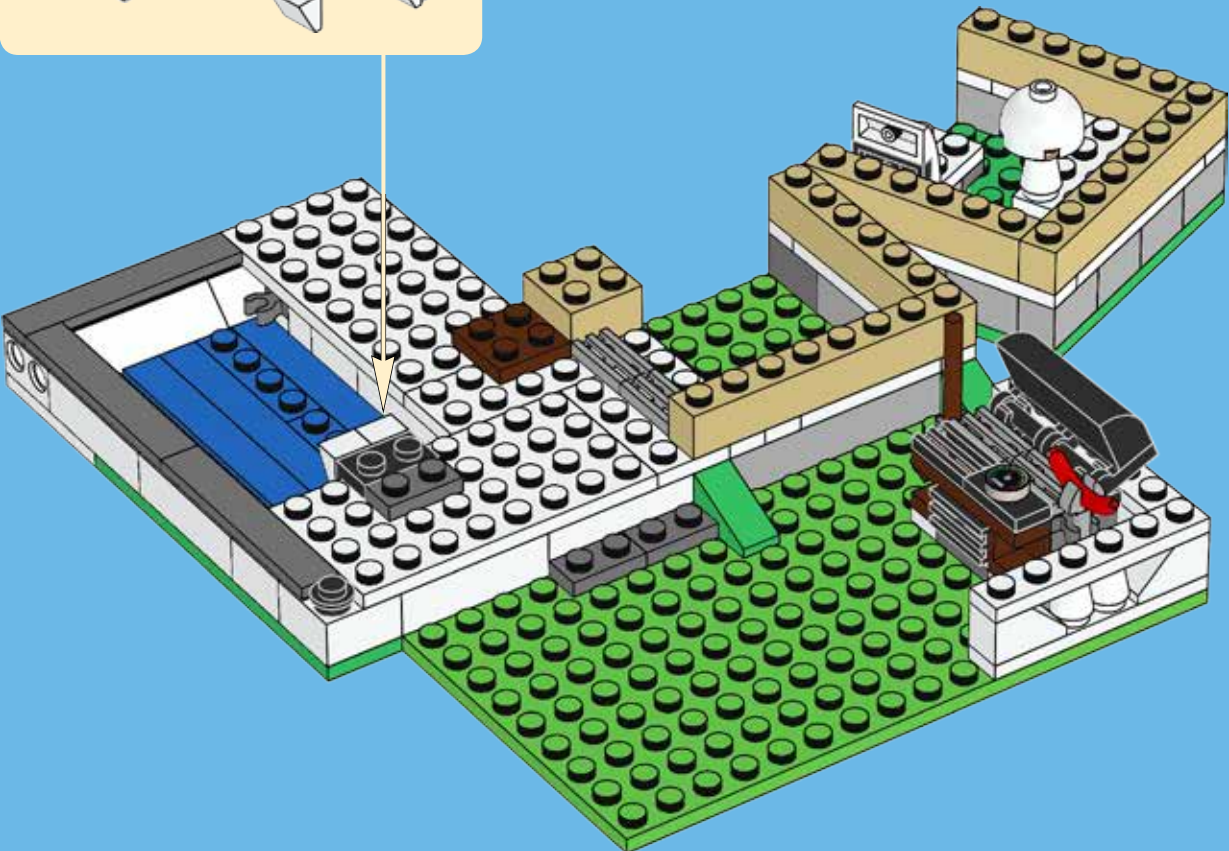
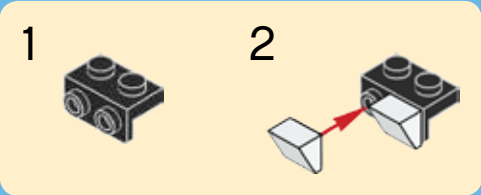

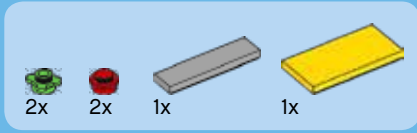

33

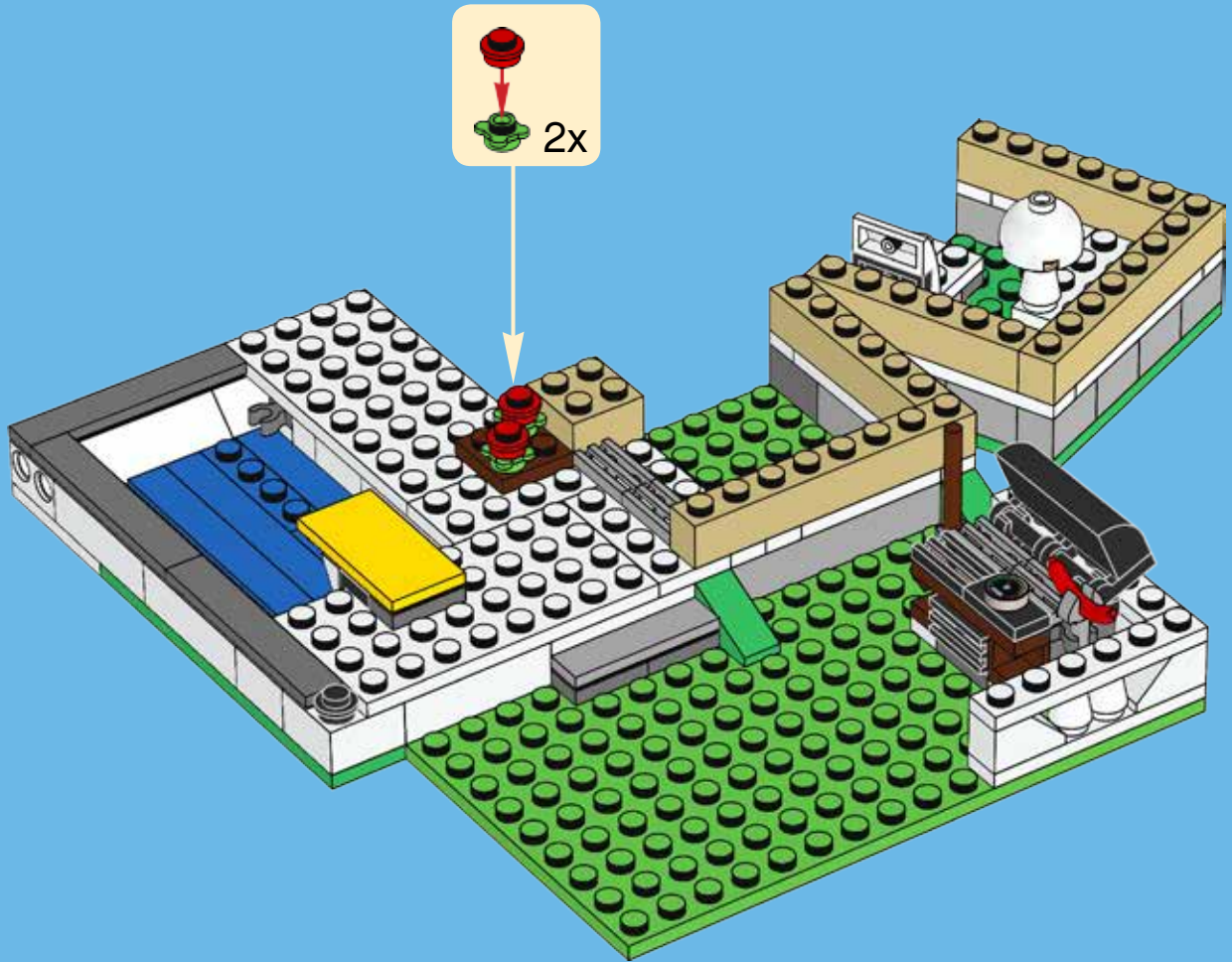



1x



2x



4x

34

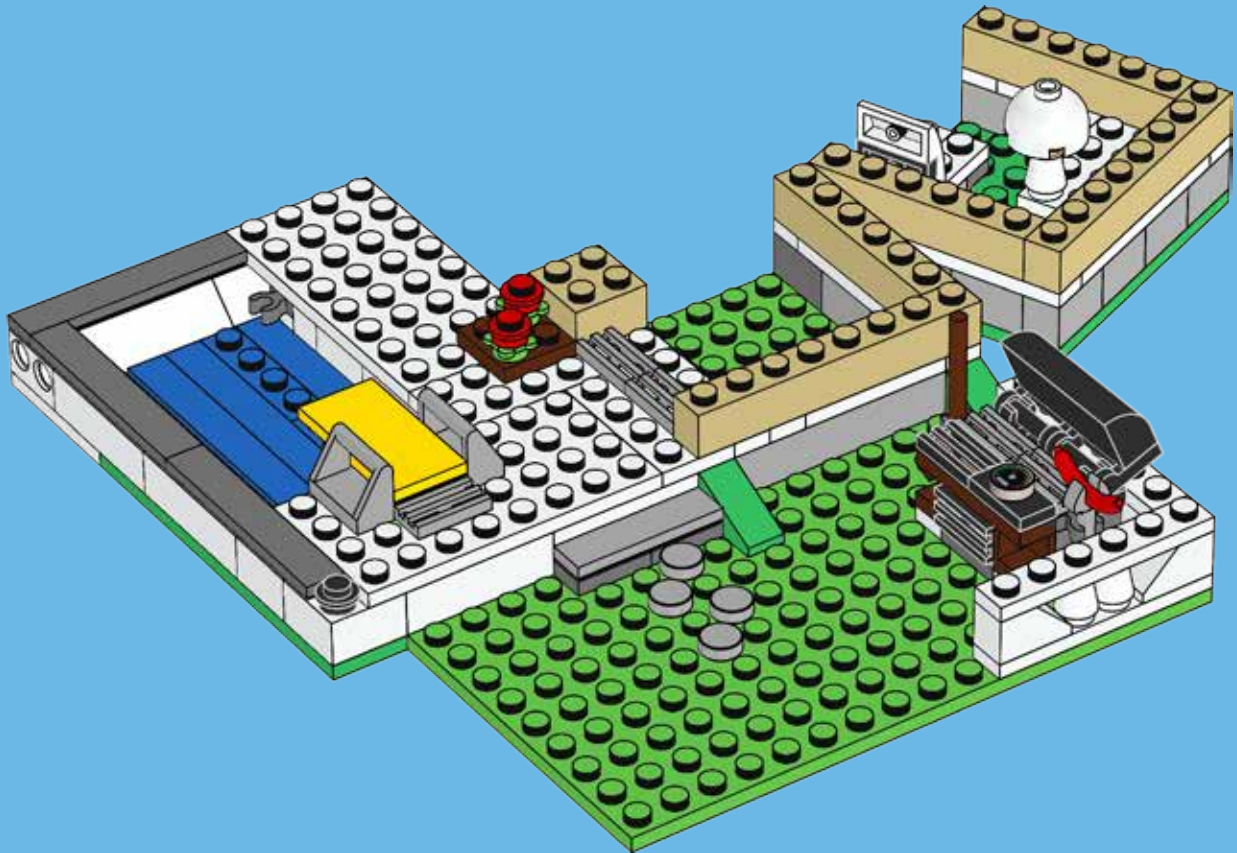



35

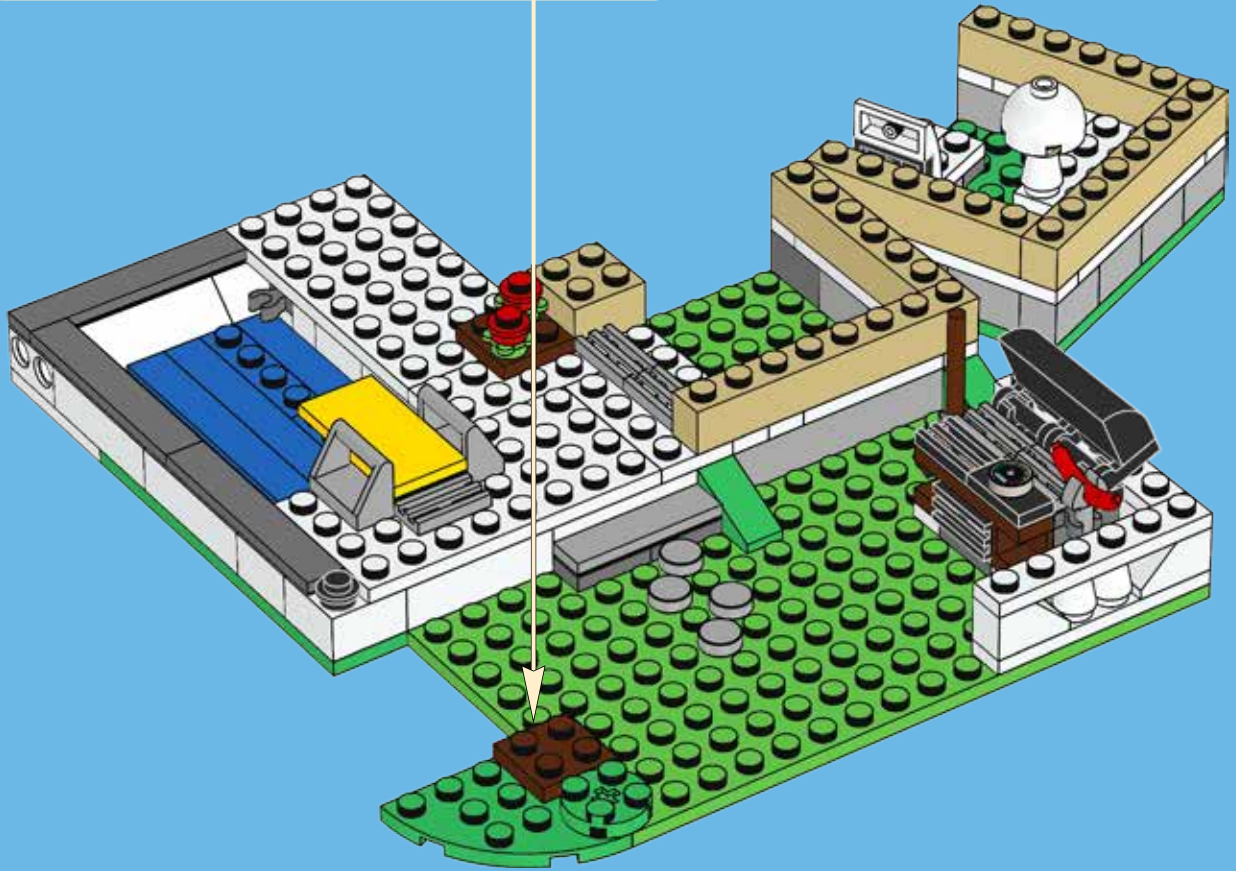
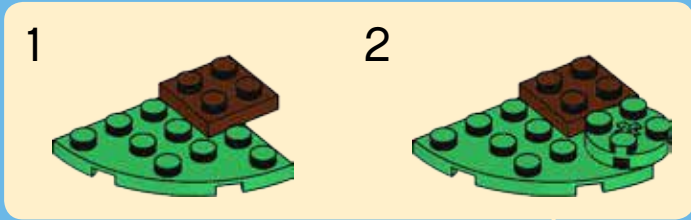



36

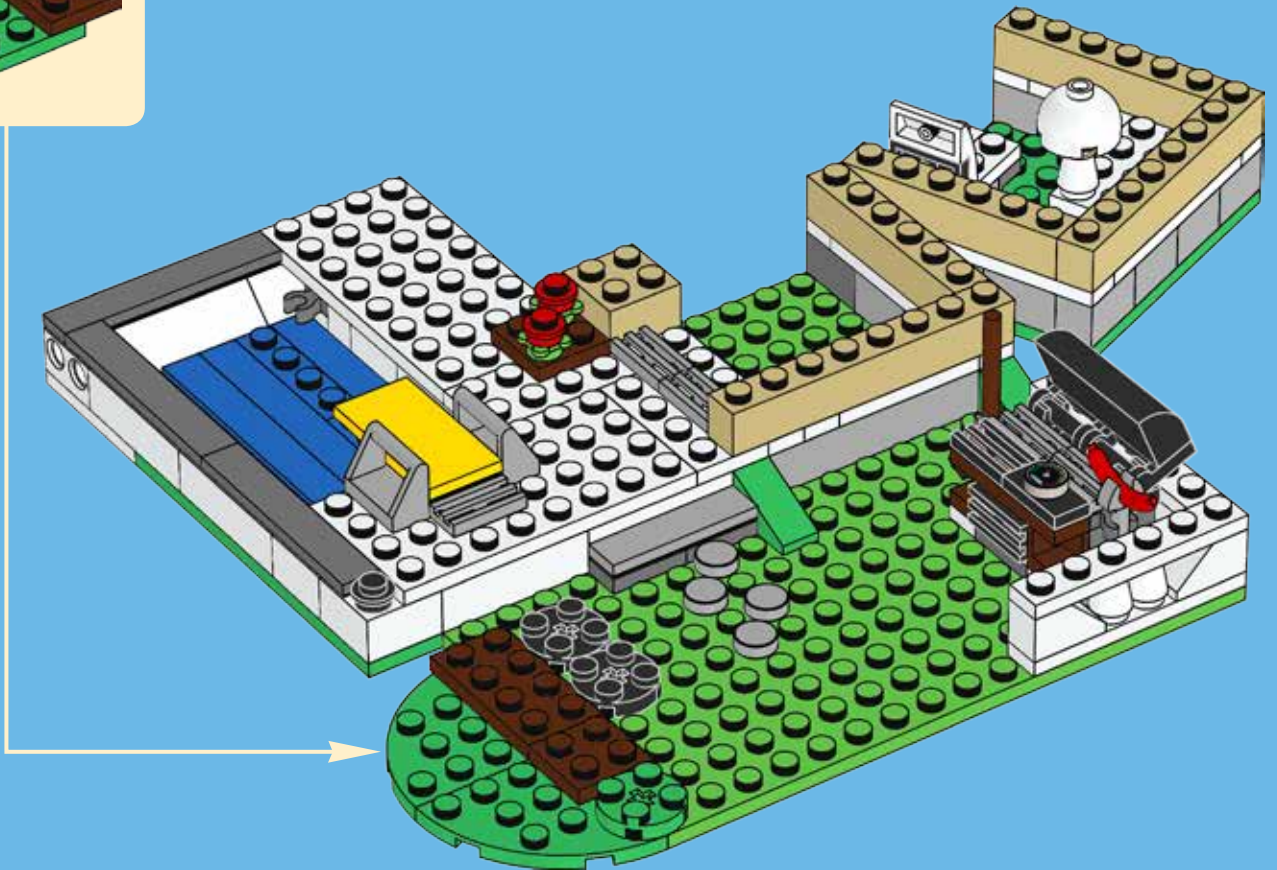



2x



2x

37

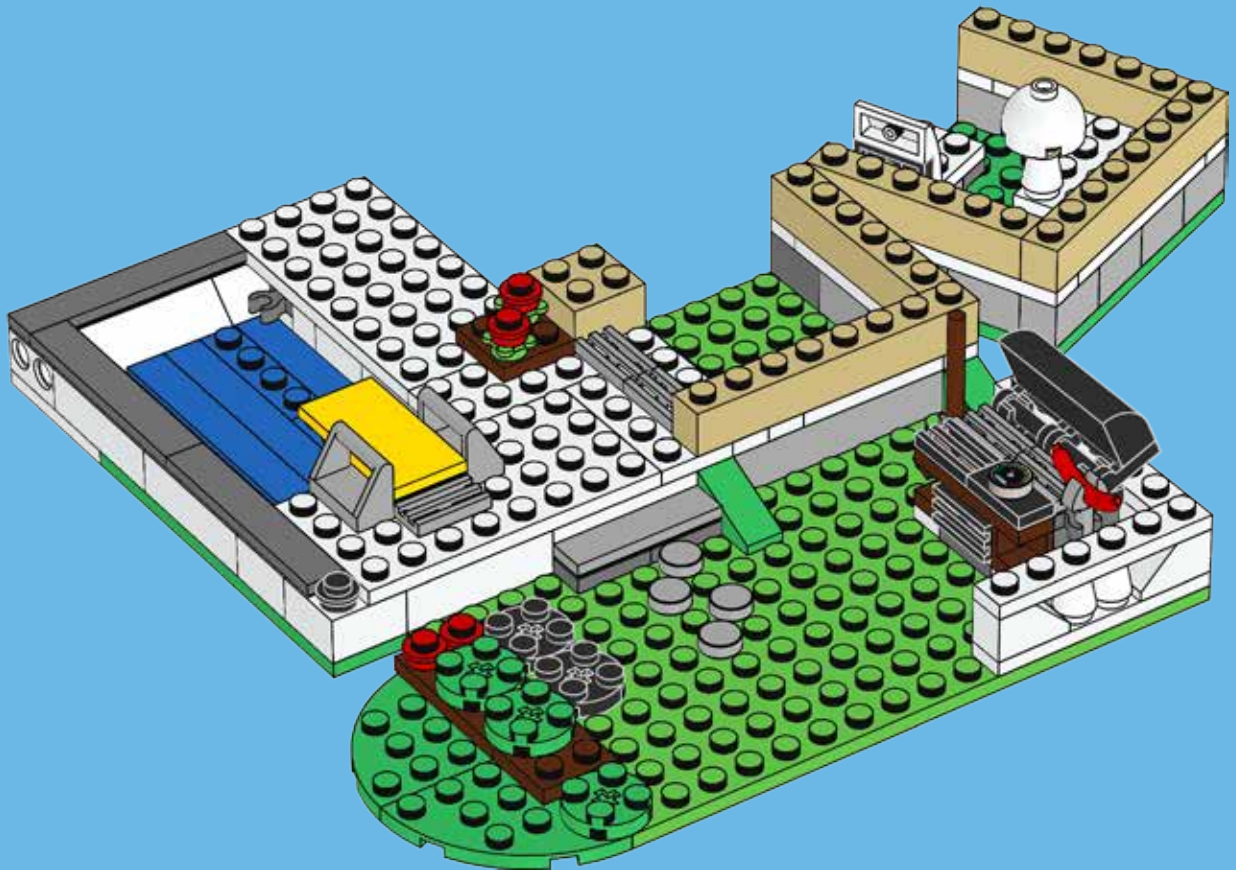



4x



2x



1x

38

1



2

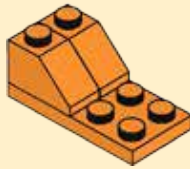

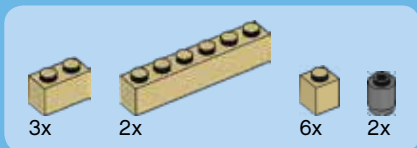

39





2x



4x



2x



4x



2x

1



2



3

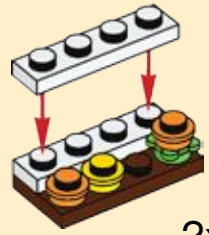

2x

40

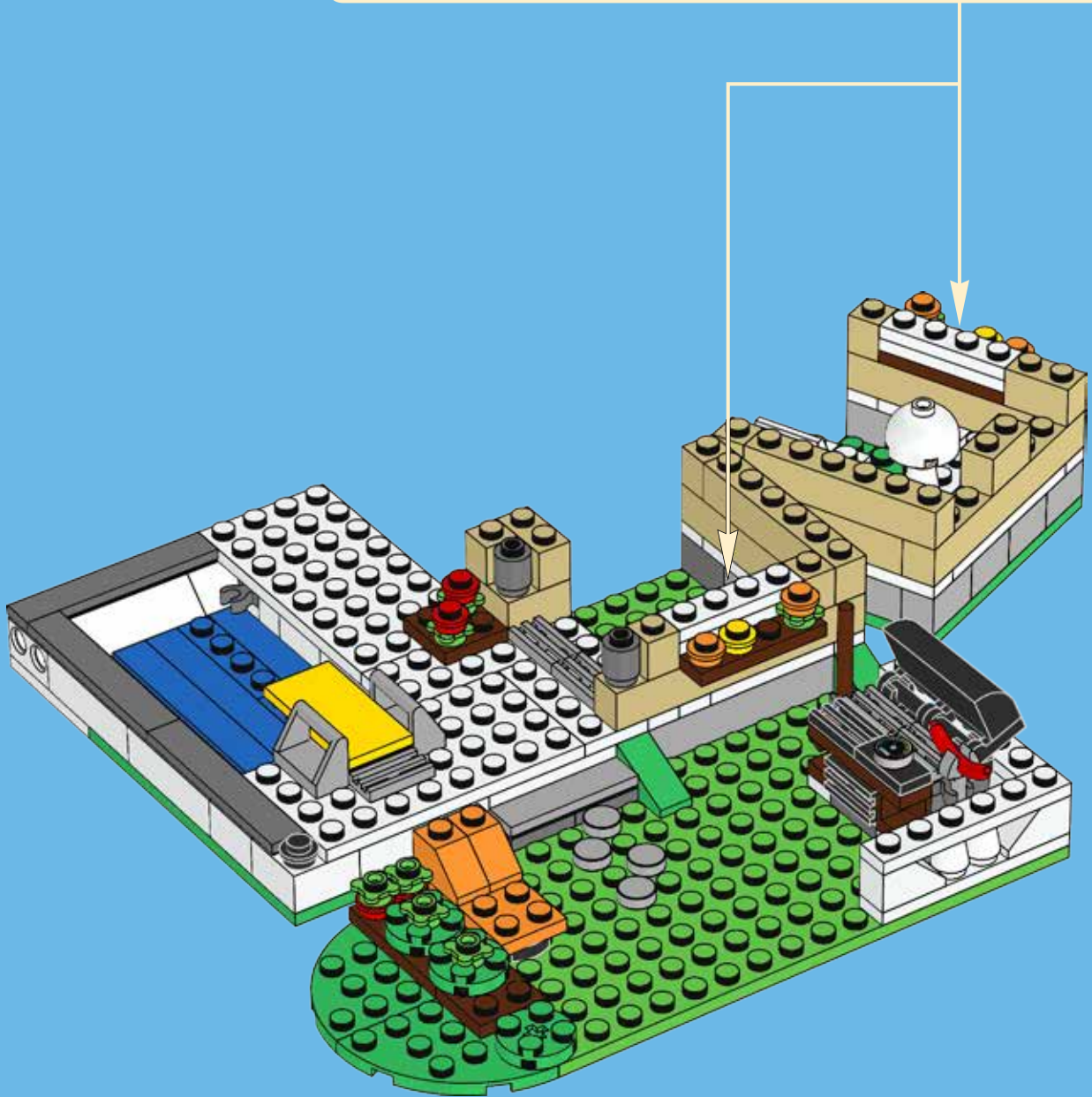



1x



2x



1x



4x



2x

41

1



2



3



1



2



3

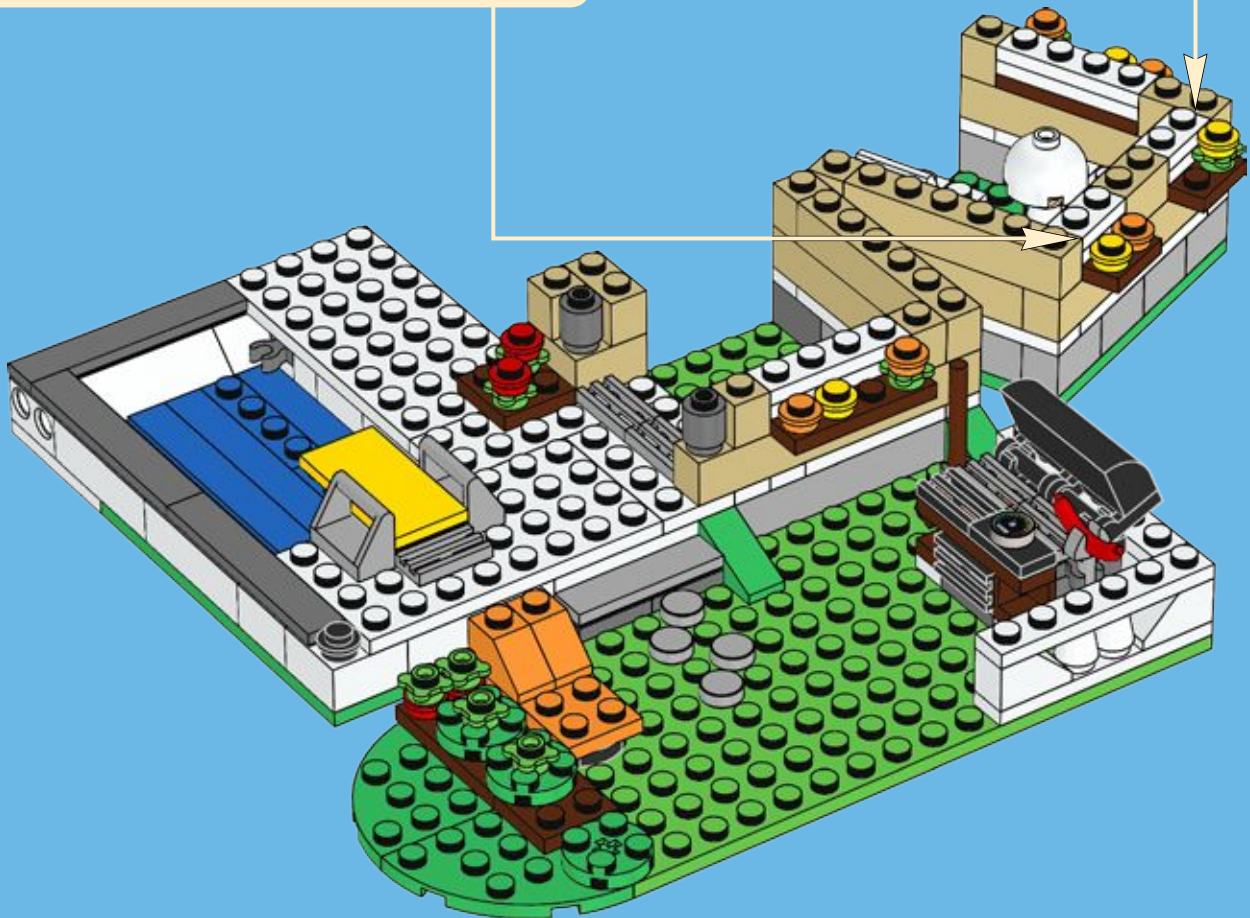

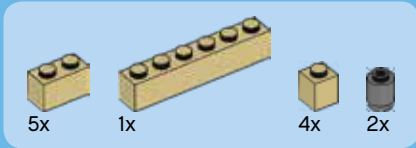

42



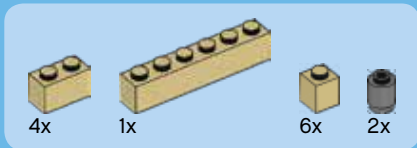

43



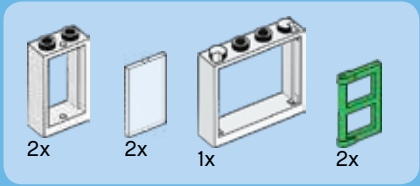

44

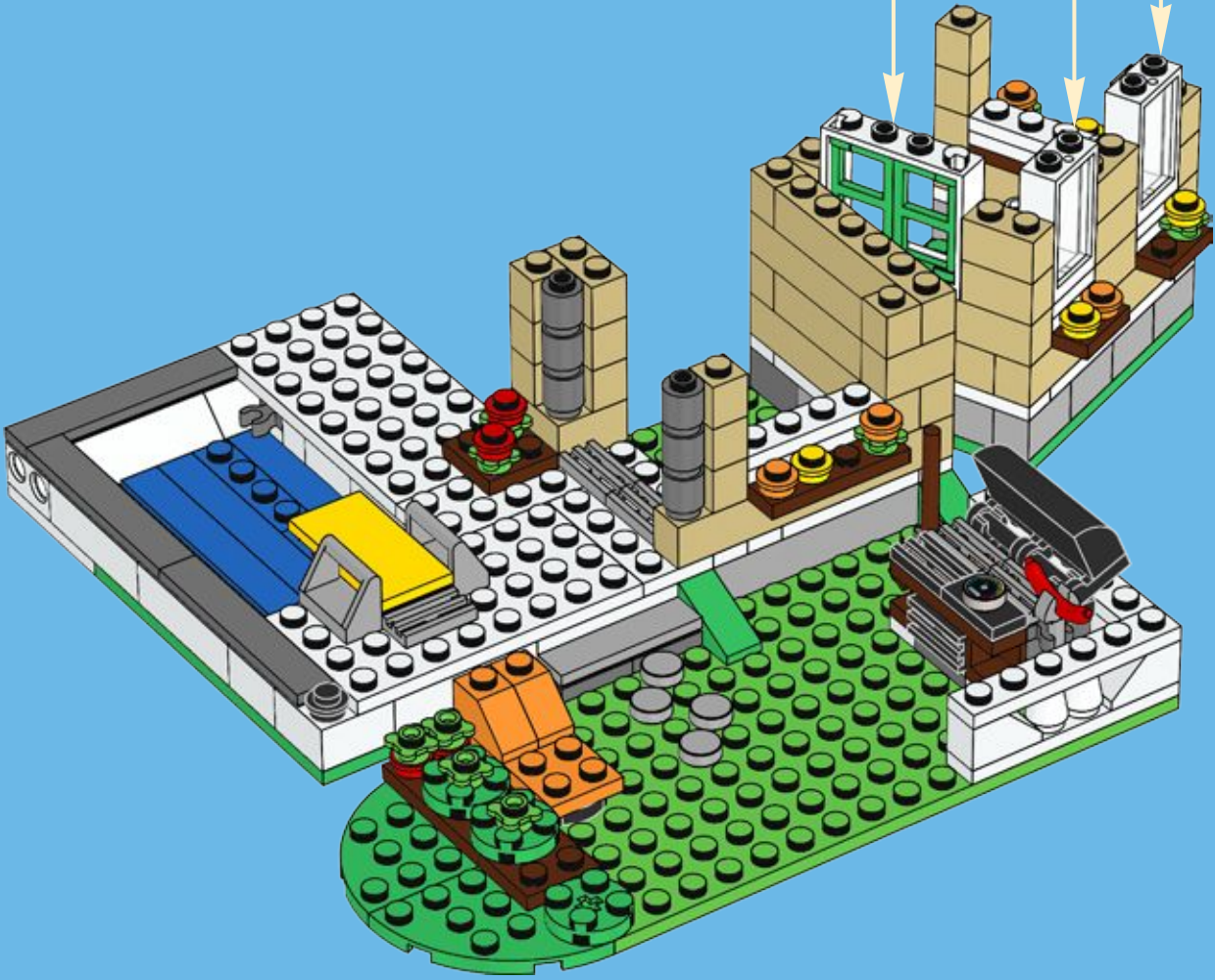
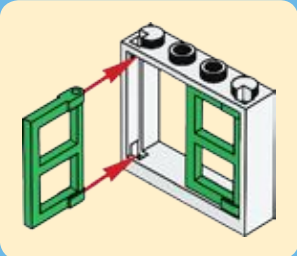
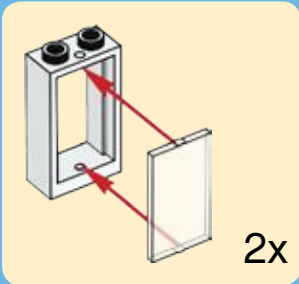



2x



5x



1x

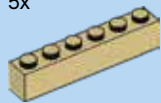

1x

45

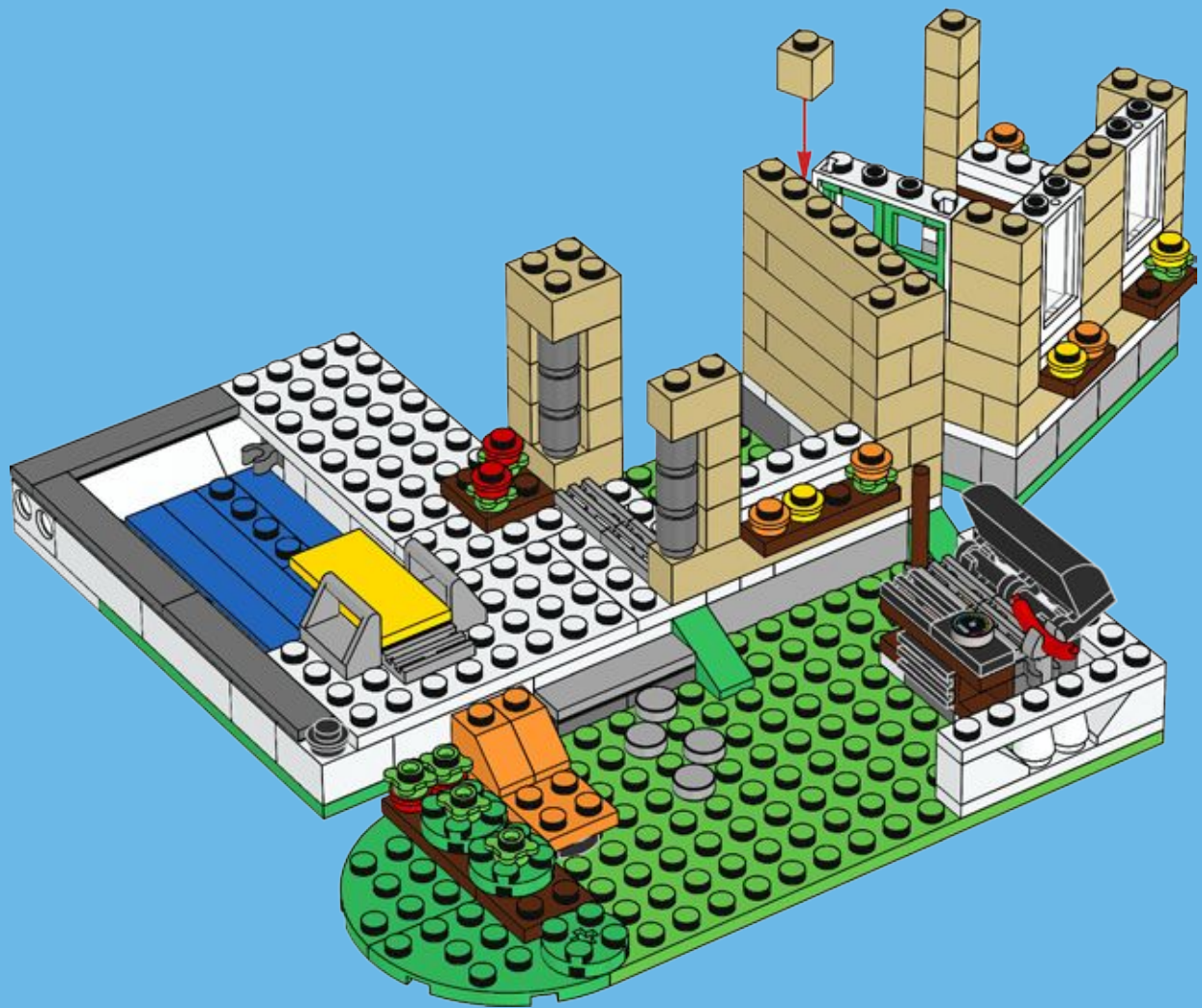

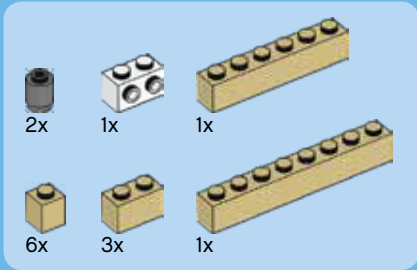

46





1x



3x

47

1



2

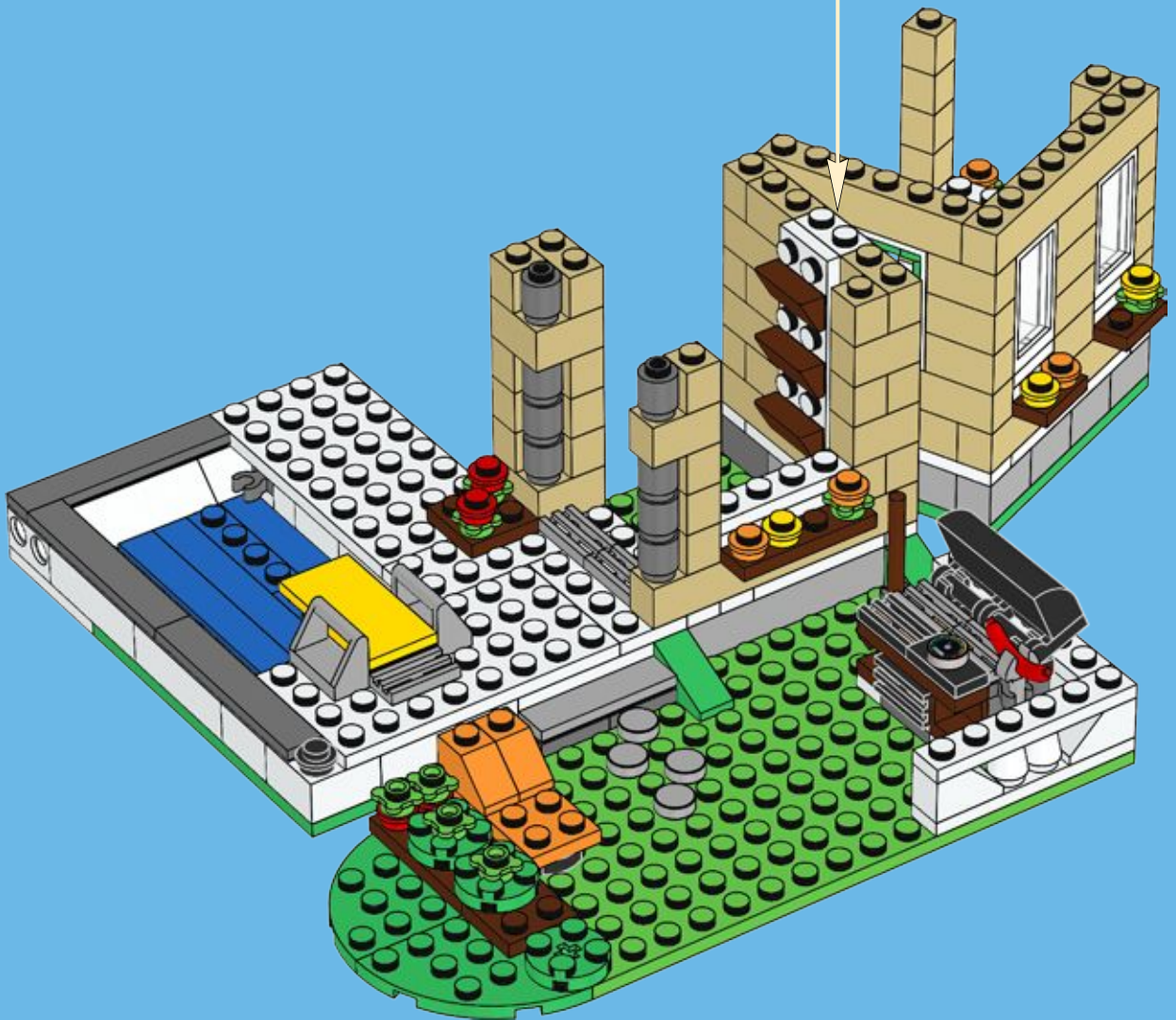
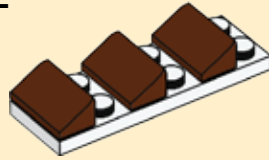

48

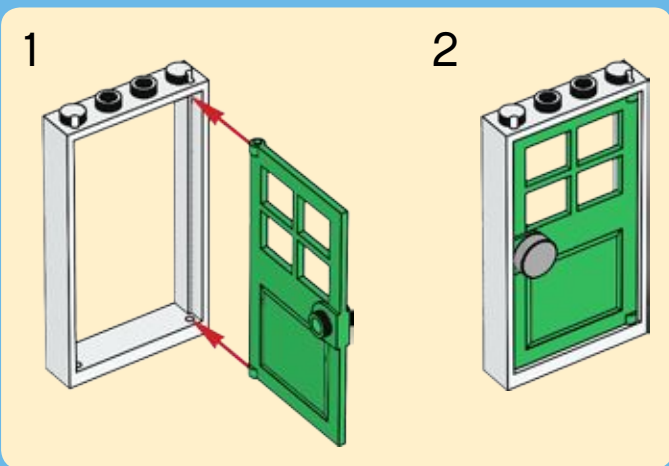
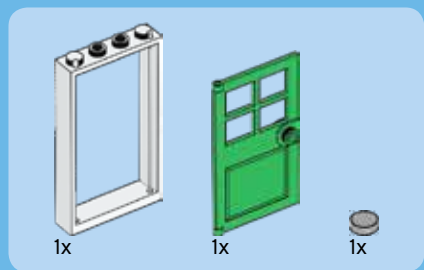

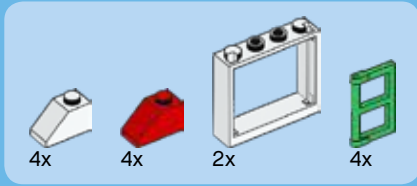

49

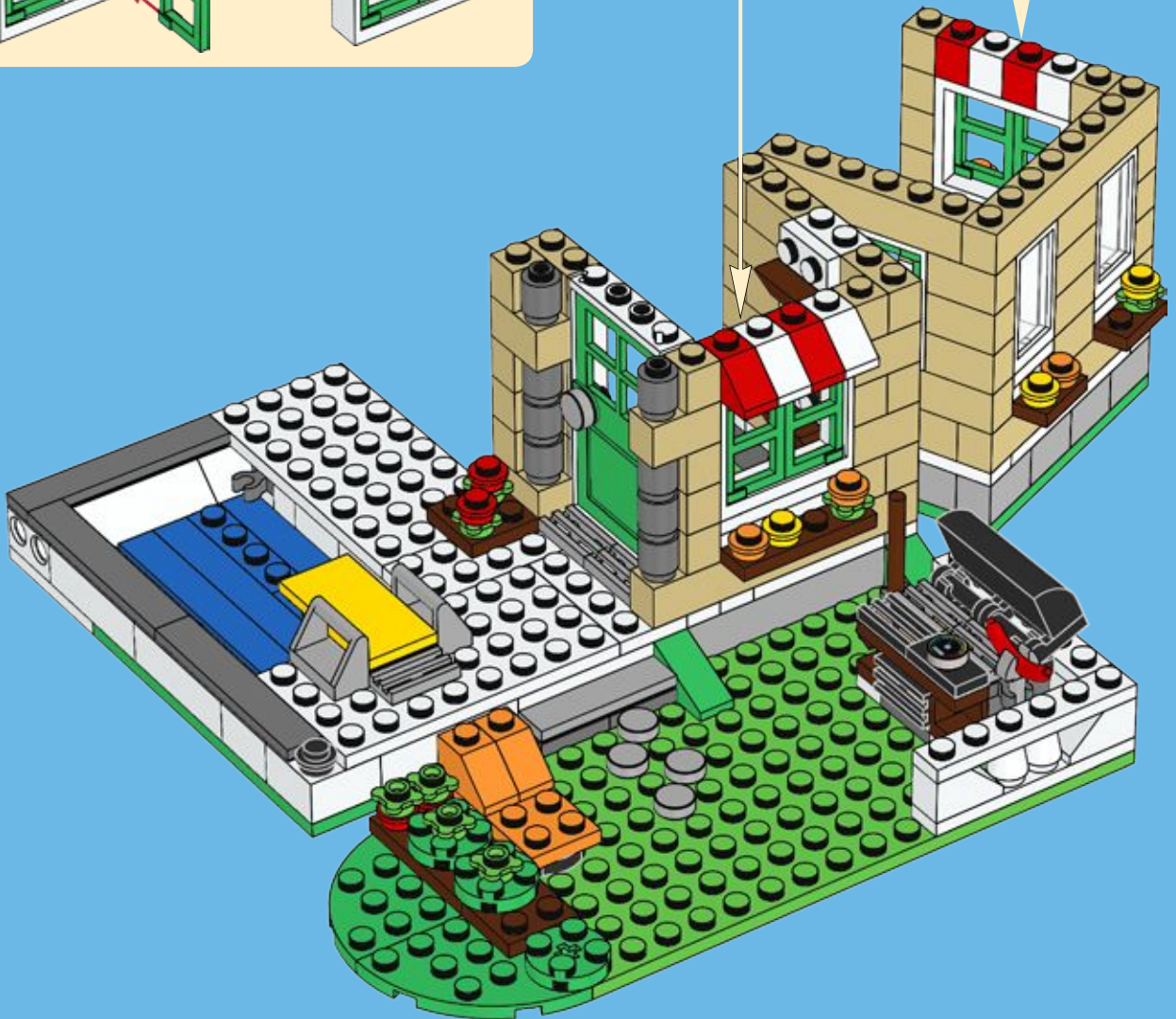
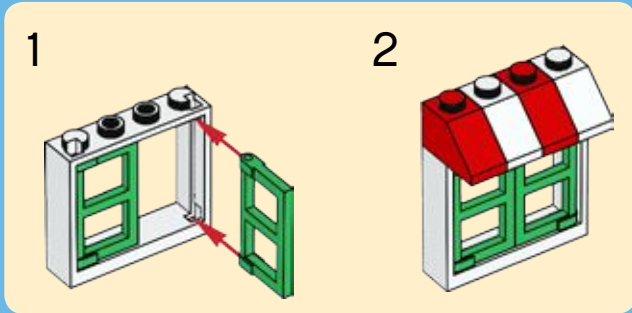
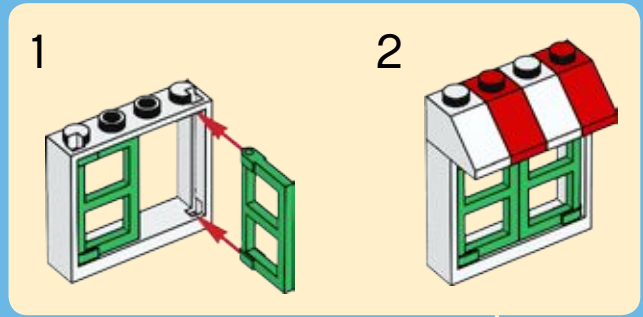

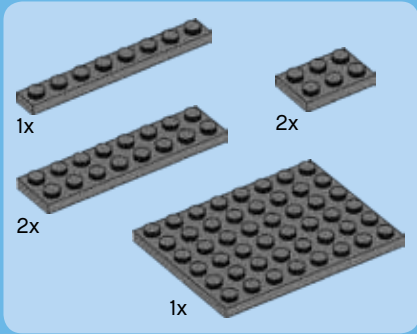

50



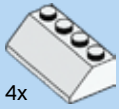

4x

51





2x



2x



2x

52





4x



2x

53



2x





4x



3x



2x



2x

54

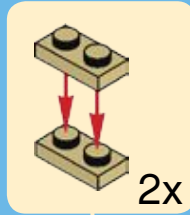

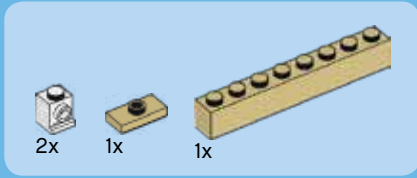

55

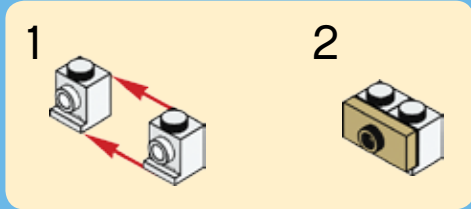



56





57

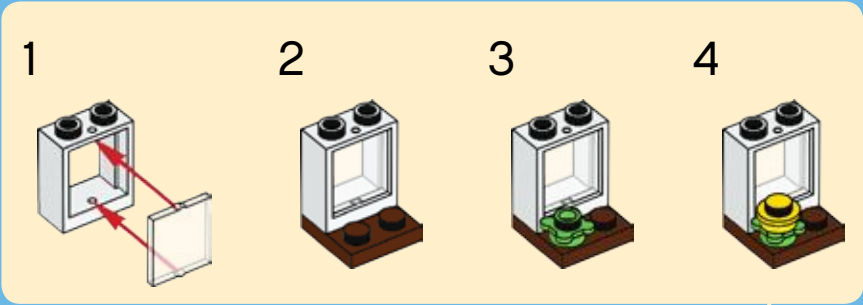

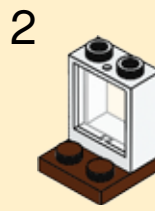
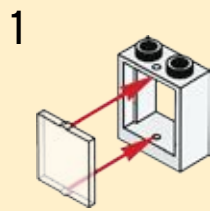

58





2x



1x



2x



2x



2x

59

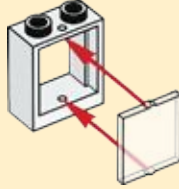

2x



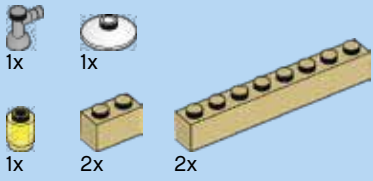

60

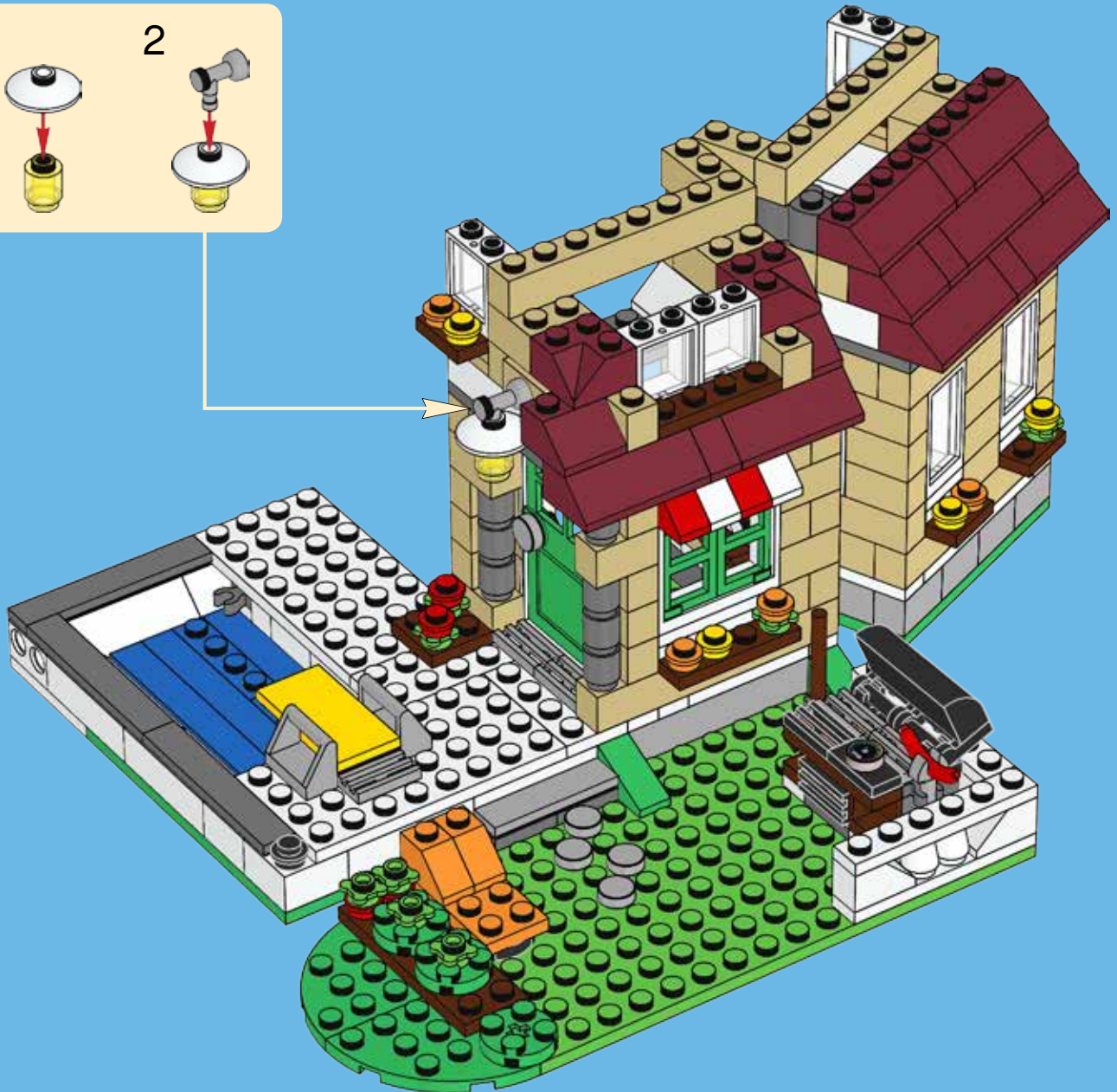
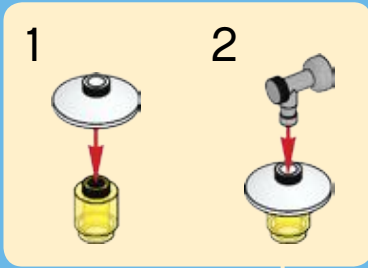



4x



1x



2x



1x

61





1x



3x



2x

62

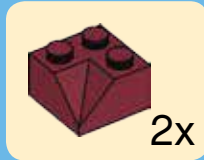

2x





1x



1x



2x



2x

63

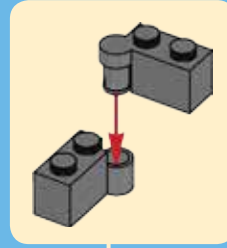



3x



2x

64



2x



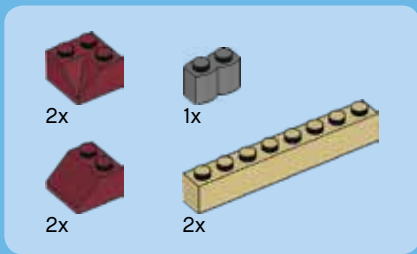

65





3x



2x



2x

66



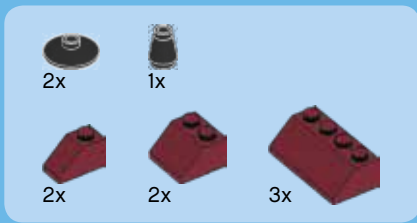

67

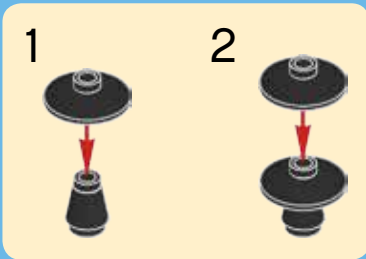



1x



1x



1x



1x

68

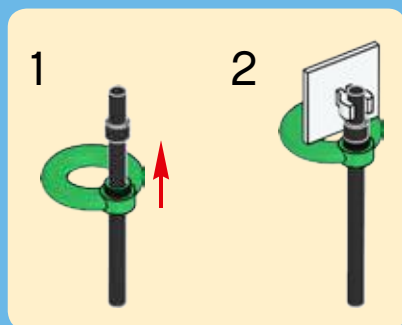

2

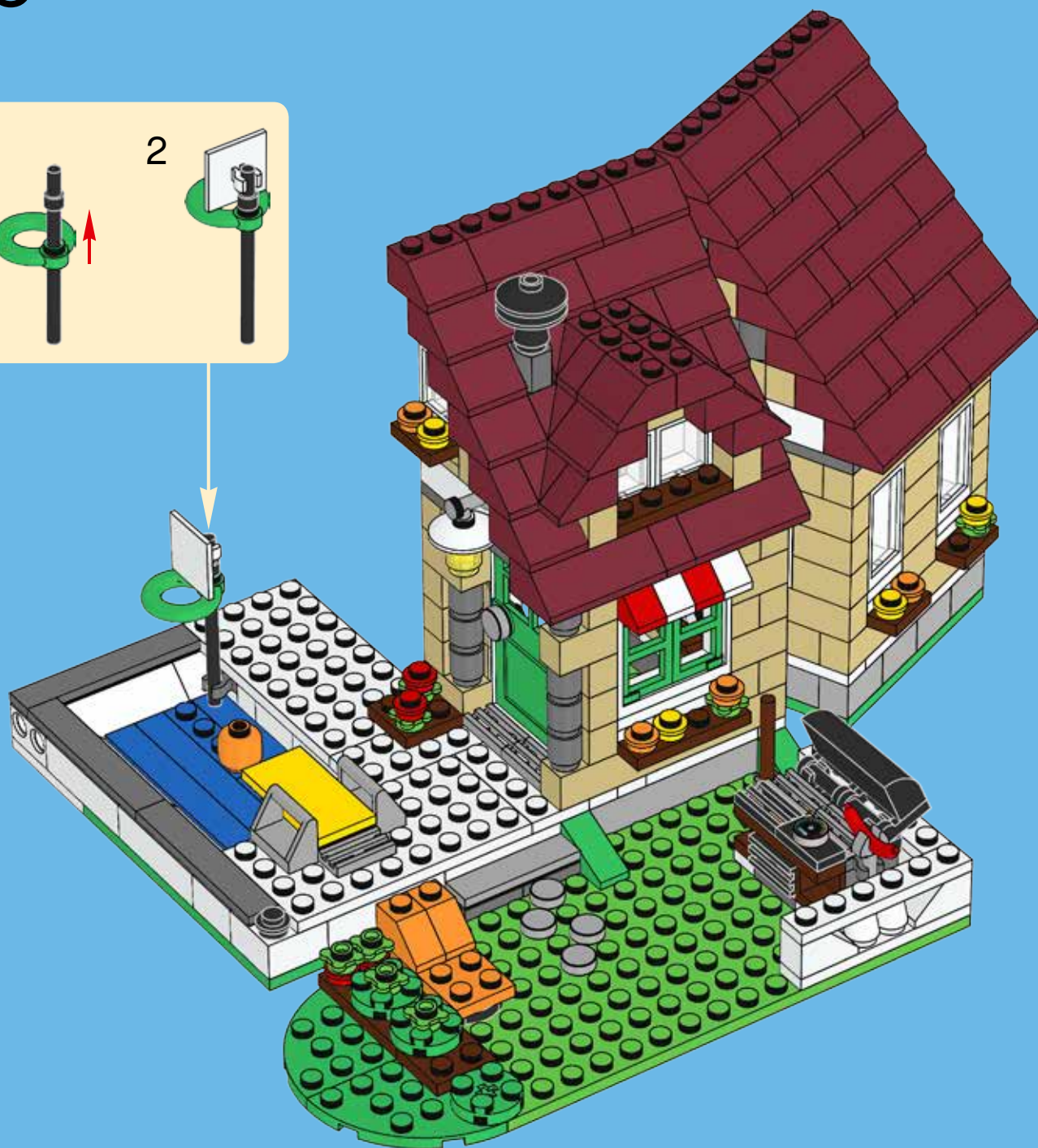

- 1x 
- 1x 
- 1x 
- 1x 
- 1x 
- 1x 

69

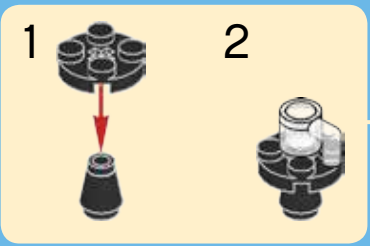
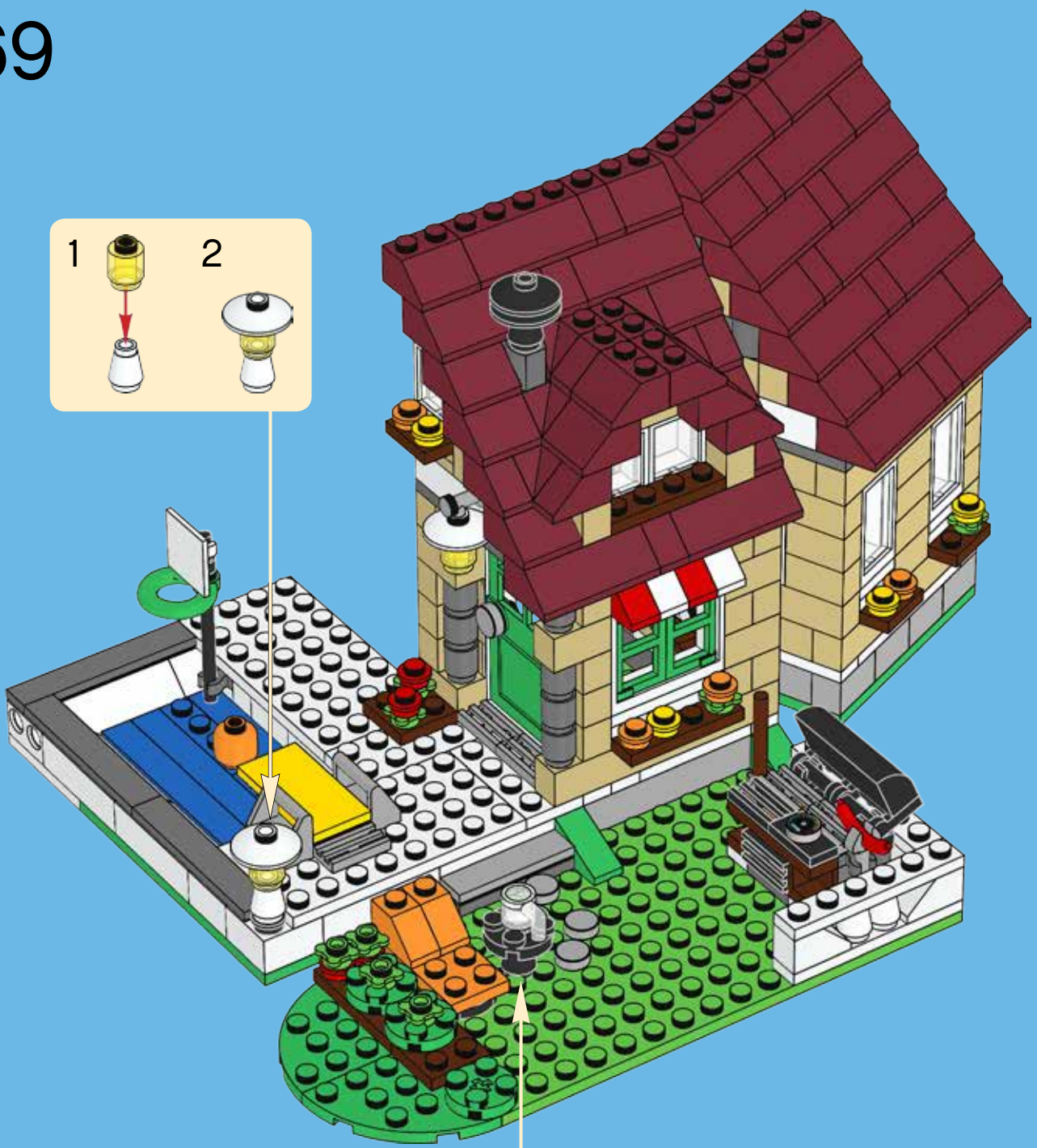
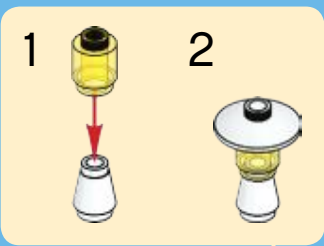



1x



1x



1x



1x



2x



2x



1x

70

1

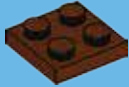

2

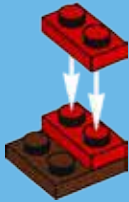

3



4



5



6

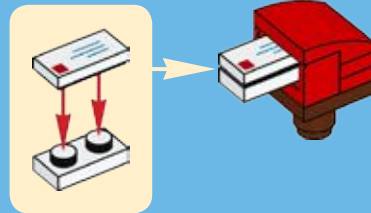



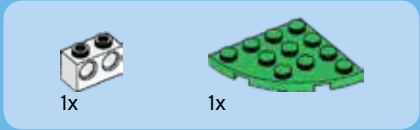

1



2



3

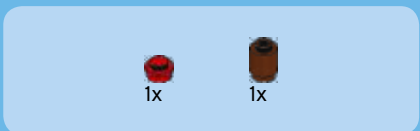

4



5

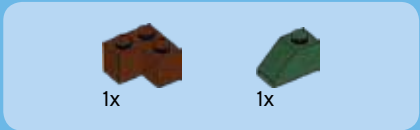

6



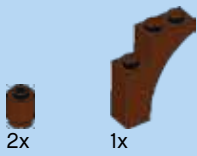

7



8



9



10





1x

11



2x

13



1x



1x

12



3x



3x

14

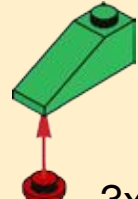

3x





1x



2x



1x



2x



1x

15

1



2



3



4



5

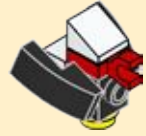

71





1x

1



1x

2



2x

3



2x

4



1x

5



2x

6





1x

7



1x

8



2x



2x

9



2x



72





1x

1



1x



2x

2

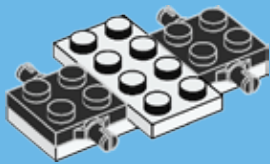

1x

3

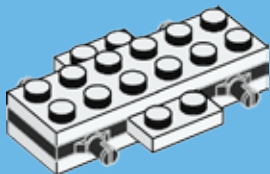

4x

4

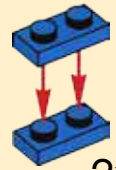

2x

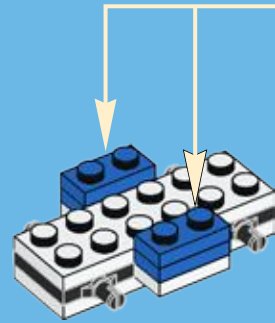

1x



1x

5

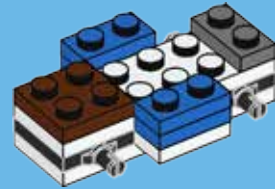

2x

6

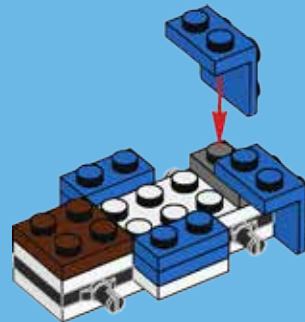



1x



1x

7

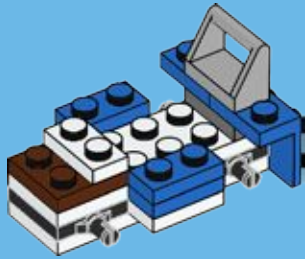

2x

9

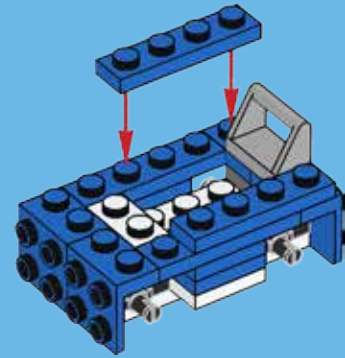

2x



2x

8

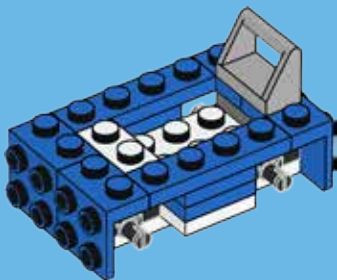

2x



2x

10

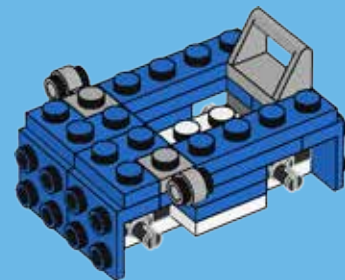



11

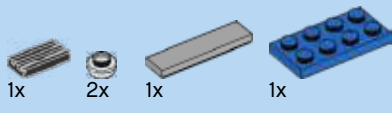
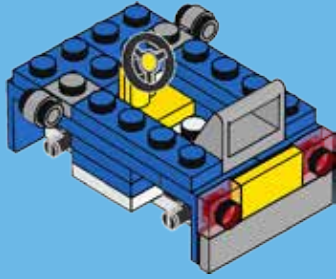

12

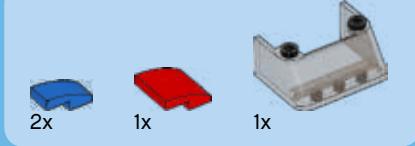
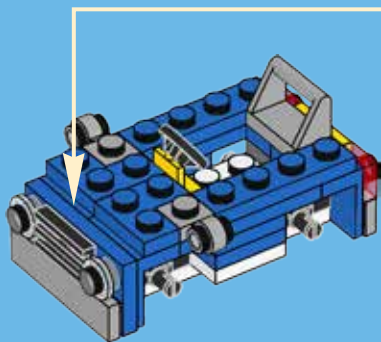
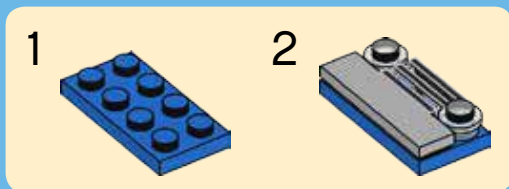

13

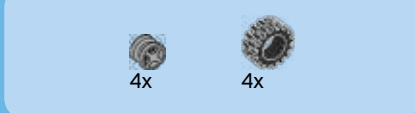
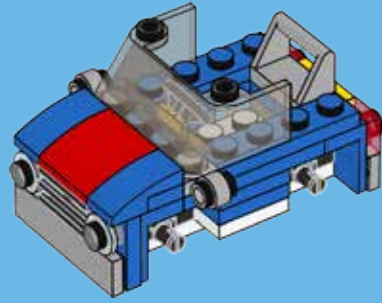

14

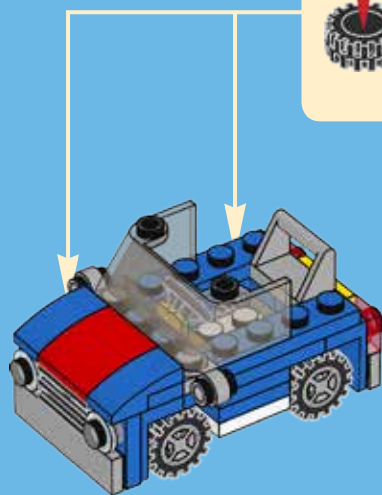
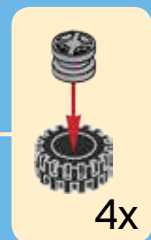

73



WIN

GO TO WWW.LEGO.COM/PRODUCTFEEDBACK
AND GIVE US YOUR SHORT **FEEDBACK**
ABOUT THIS LEGO® SET FOR A CHANCE
TO WIN A COOL LEGO PRIZE.



LEGO.com/productfeedback

GEWINNE



Erzähle uns auf
www.LEGO.com/productfeedback

etwas über die Erfahrungen, die du
mit diesem LEGO® Set gemacht hast,
und sichere dir die Chance auf einen
coolen LEGO Preis!

GAGNE



Rends-toi sur
www.LEGO.com/productfeedback

et donne-nous quelques commen-
taires sur ce produit LEGO® pour avoir
une chance de gagner un prix LEGO !

GANAN



Visita
www.LEGO.com/productfeedback

y envíanos tu opinión acerca de este
set LEGO®. ¡Participarás en el sorteo
de un premio LEGO!

获取奖品



登录
www.LEGO.com/productfeedback

给出关于此乐高®套装的简短反馈，
就有机会获得炫酷乐高奖品

경품 당첨 기회



www.LEGO.com/productfeedback

페이지로 이동하여 이 레고® 세트에
대한 간략한 피드백을 보내 주시고
멋진 레고 경품을 탈 수 있는 기회도
잡으십시오

ЗАПОЛНИ АНКЕТУ И ПОЛУЧИ ПРИЗ



Перейди по ссылке
www.LEGO.com/productfeedback

ответь всего на несколько вопро-
сов об этом наборе LEGO®, и у тебя
появится шанс выиграть замеча-
тельный приз от компании LEGO.



CREATOR

31038



LEGO.com/creator



1x



1x

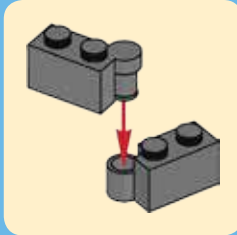

1

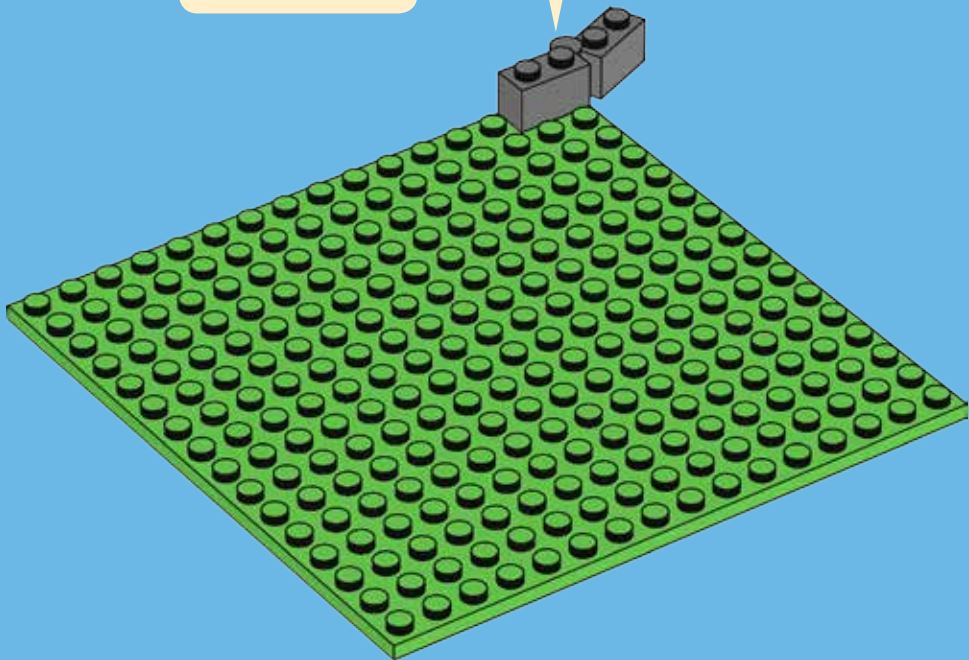

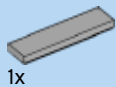

1x



4x

2

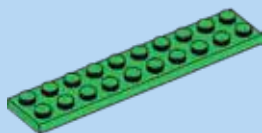
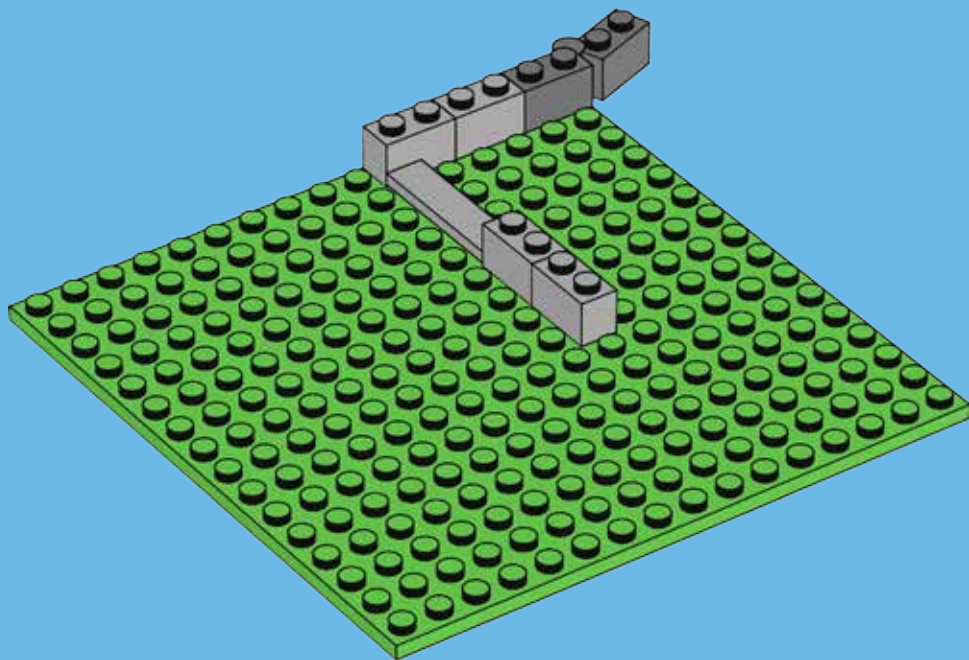

1x

3

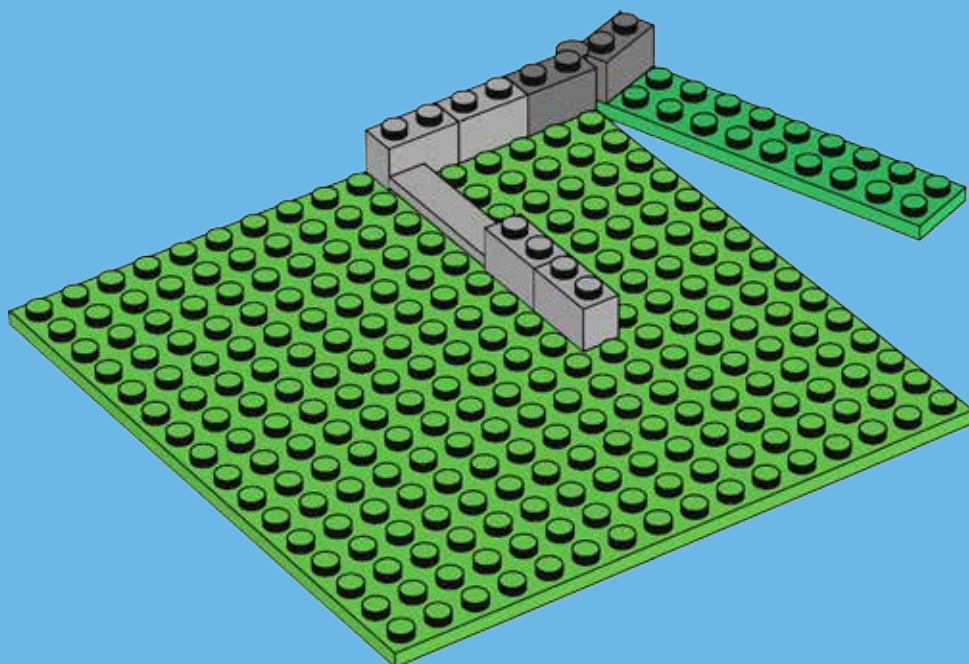

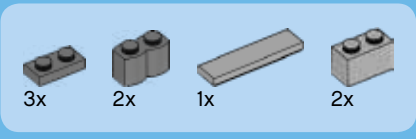

4

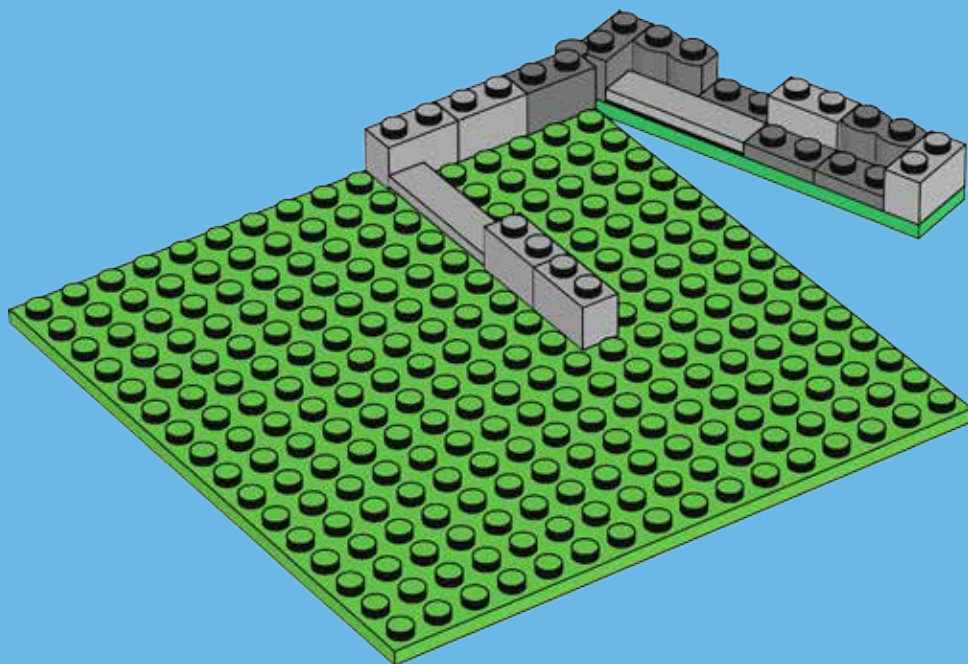

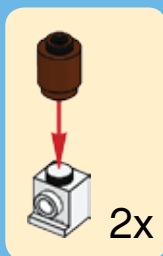
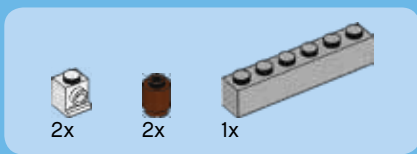

5

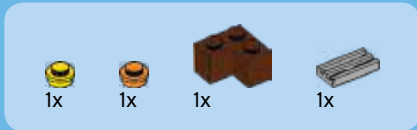
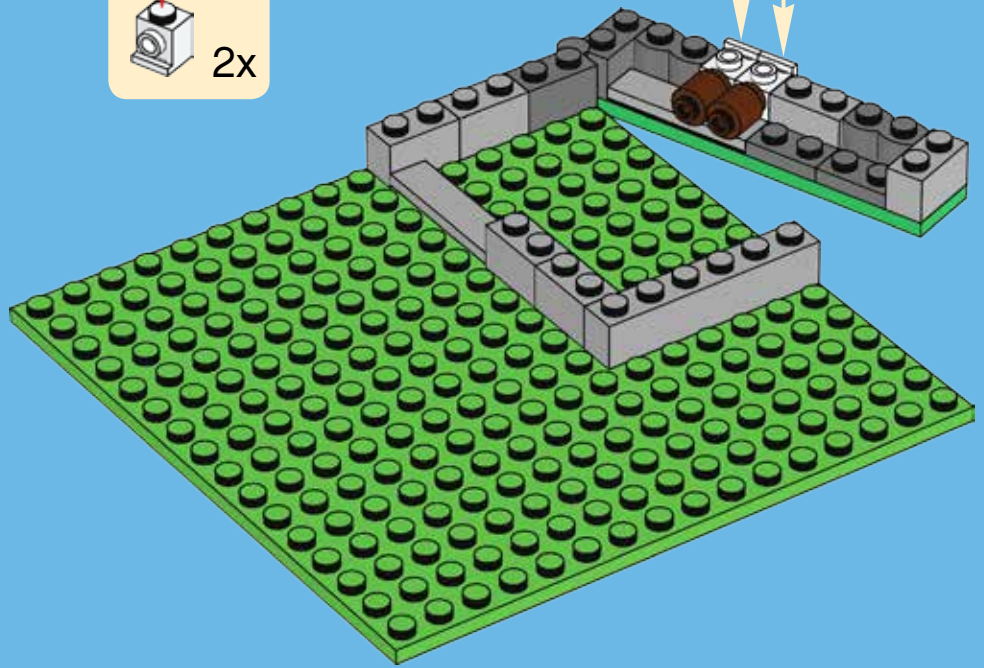

6



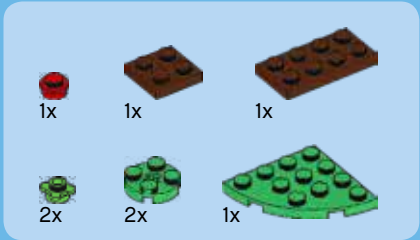

7

1



2

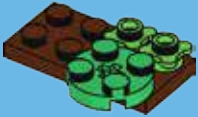

3



4



5



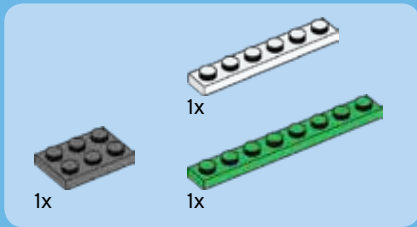

8

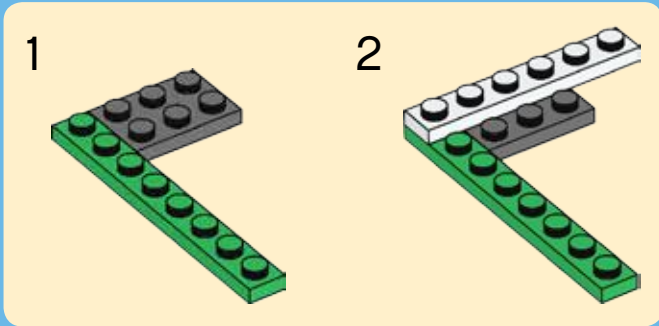



1x

9





1x

10

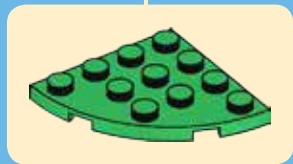



1x



1x



2x



2x

11





3x



1x

12





2x

13



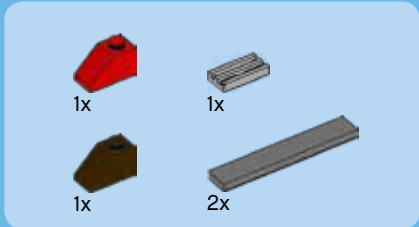

14





1x



1x



1x



1x

15





16





1x

1

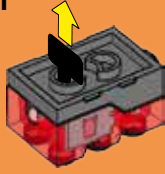

2



17





1x



1x



1x



1x

18





1x



1x



1x



1x

19



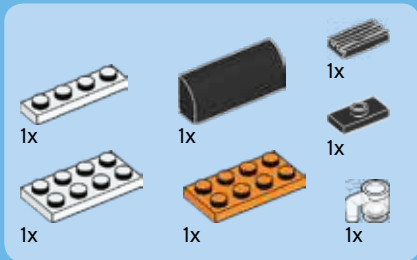

20

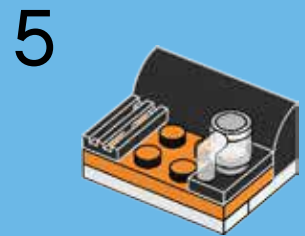
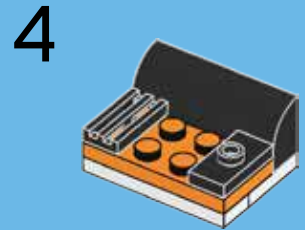
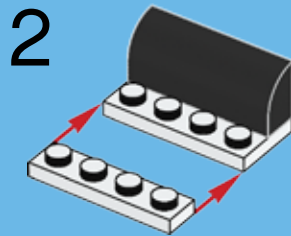
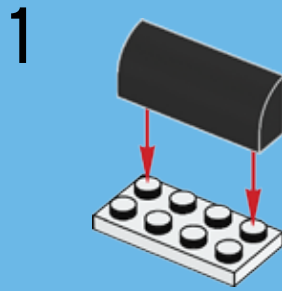

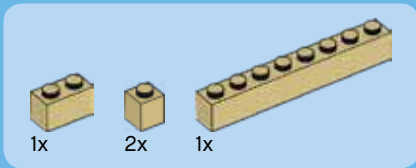

21





1x



2x



2x

22



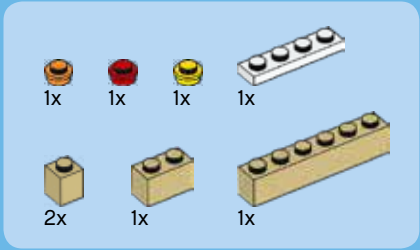

23



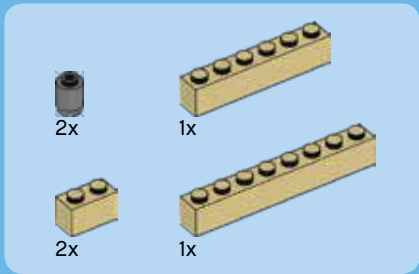

24





25

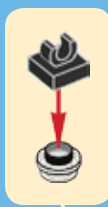
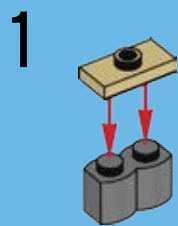



1x



2x



1x

26





2x



1x



1x

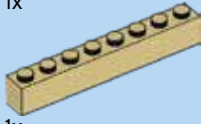

1x

27





1x



2x



2x

28



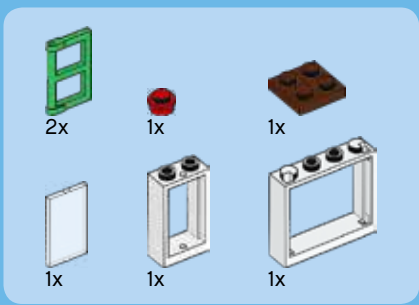

29

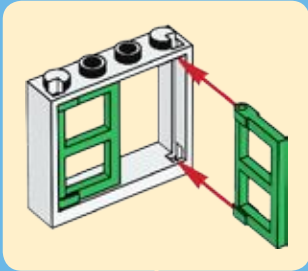
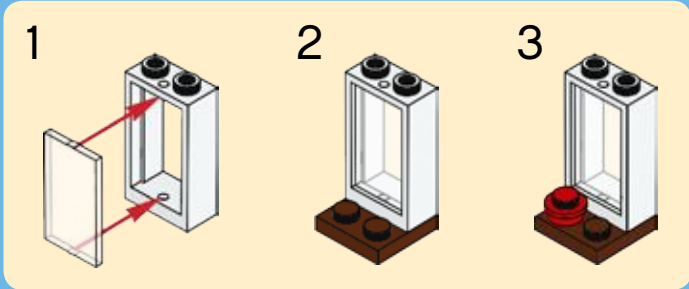



2x



3x



2x



1x

30





31

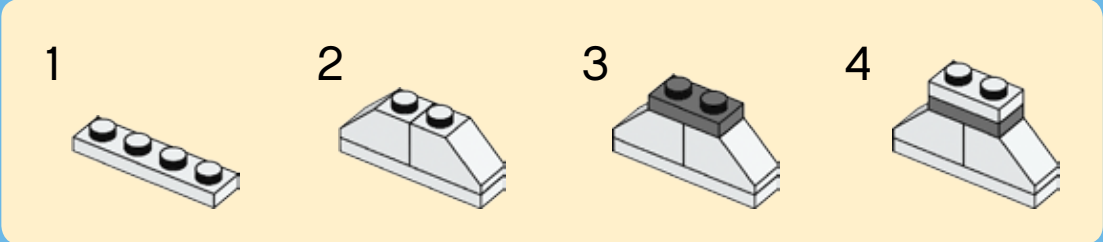

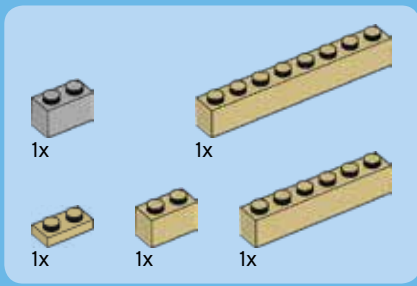

32



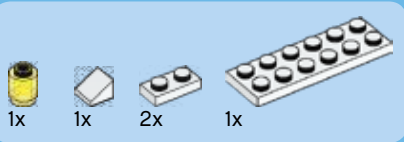

33

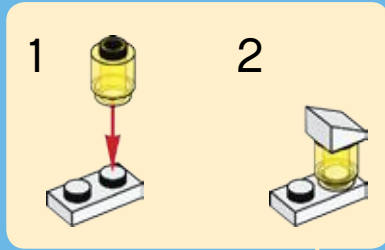

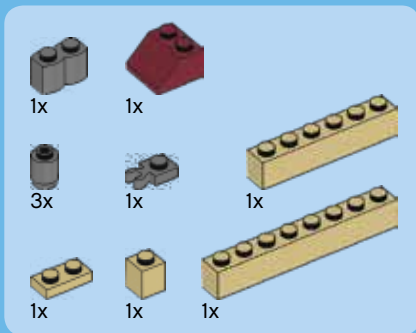

34

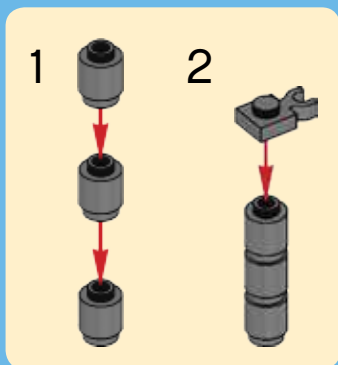

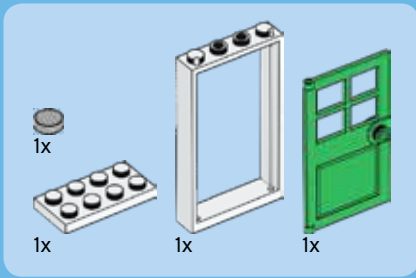

35

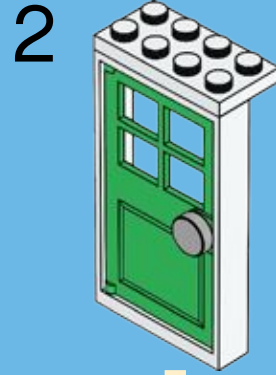
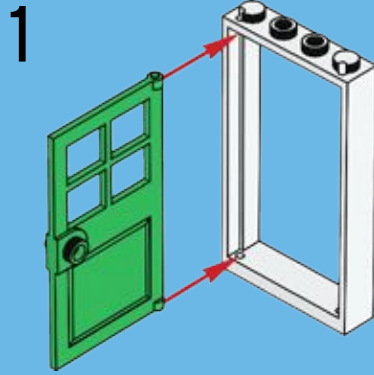

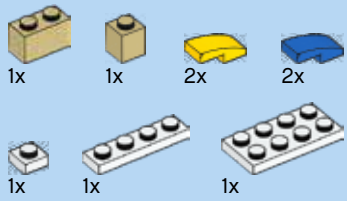

36

1

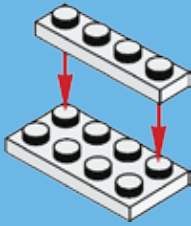

2



3

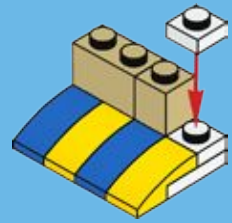



1x



1x



2x



1x

37

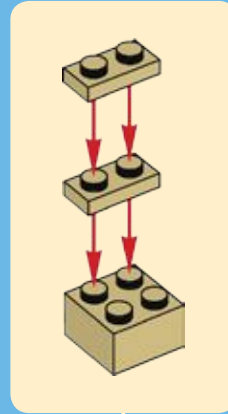



1x



1x



1x



1x

38





2x



10x

39

1



2



3



2x



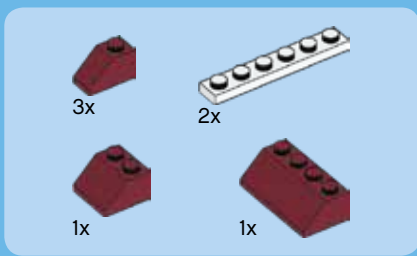

40





4x



1x



1x

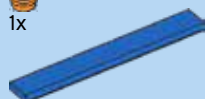

3x

41



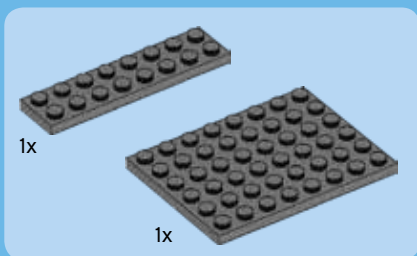

42



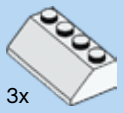

3x



1x

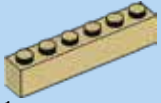

1x

43





1x



2x



1x



2x

44

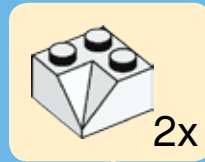

2x





2x



1x



1x



1x



1x

45



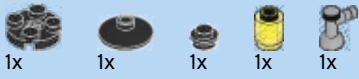

46

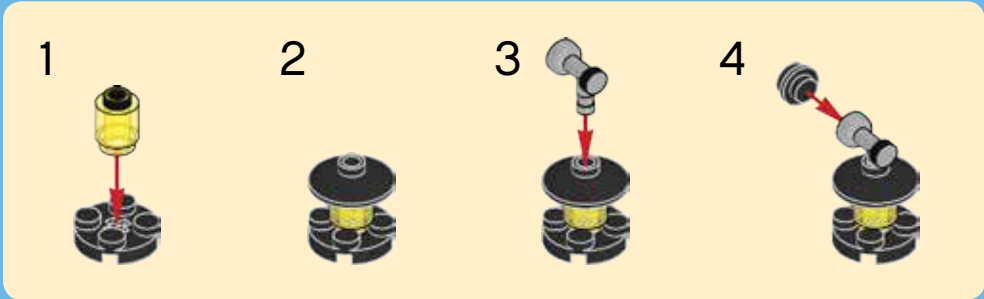



1x



1x



3x

47





2x



1x



1x

48

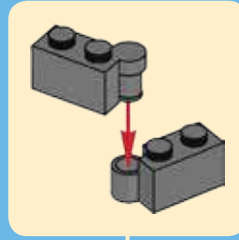

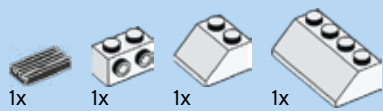

49

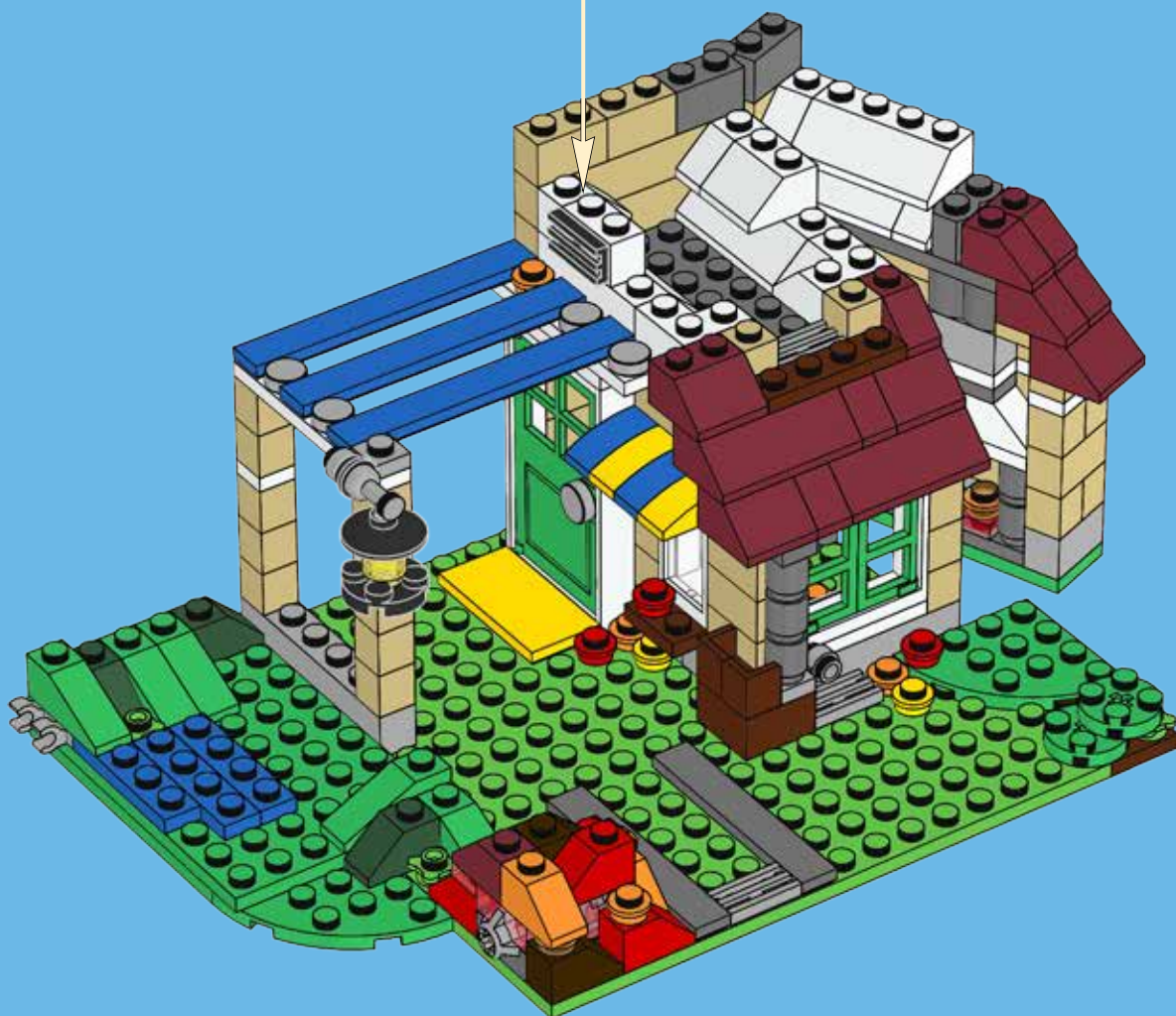
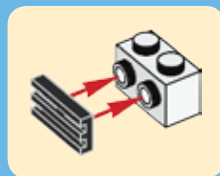



2x



1x



1x

50



2x

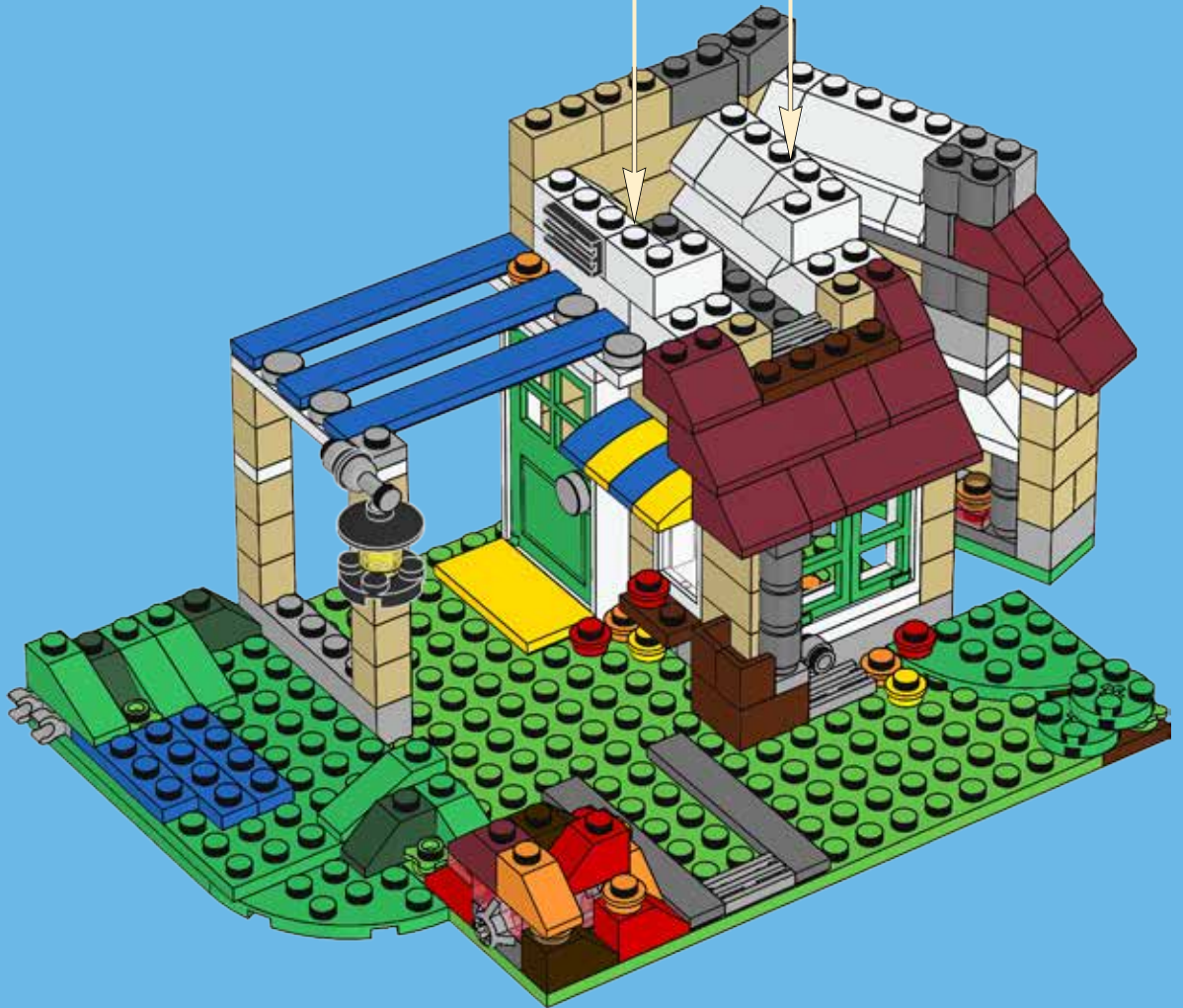



1x



1x



2x



1x



1x



1x



1x

51

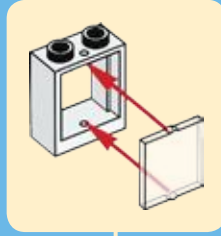



1x



1x



1x

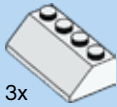

3x

52



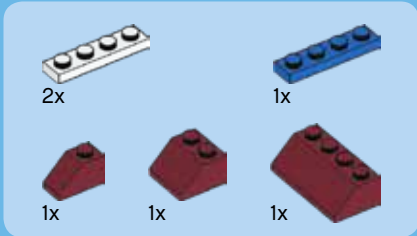

53

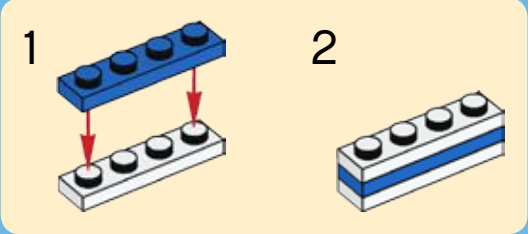

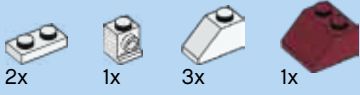

54

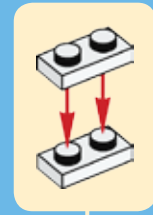



3x



1x

55

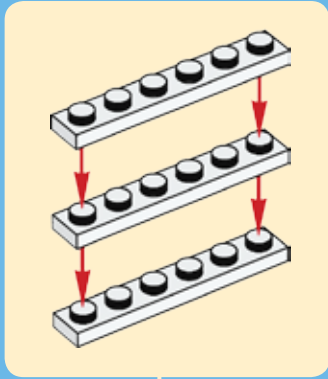



1x



1x



2x

56





1x



1x



2x

57





1x



1x



2x

58





1x



2x

59



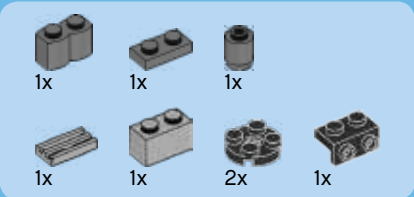

60

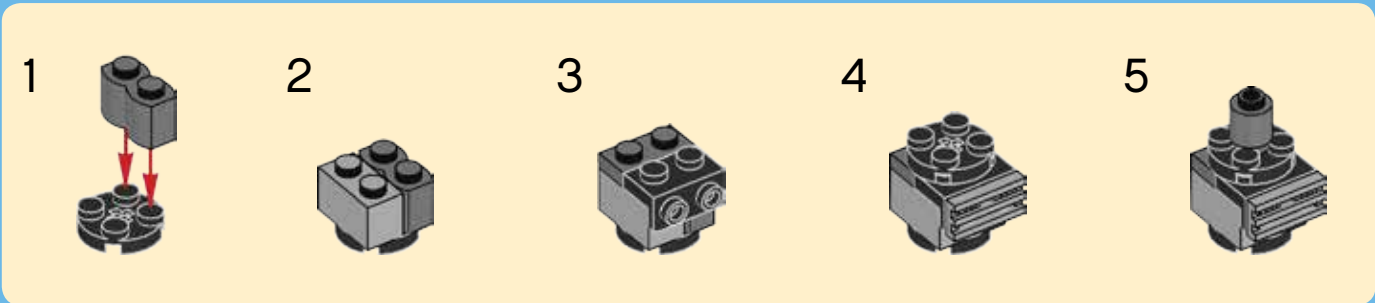



2x



1x



1x



1x



1x



1x



1x

61

1

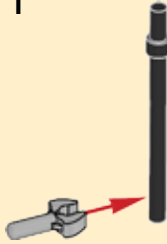

2



3

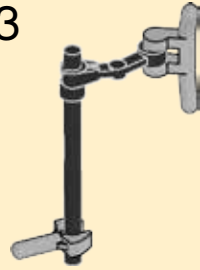



2x



1x



1x



2x



1x

62

1



2

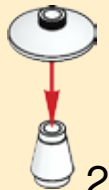

2x





2x



2x

63

1



2

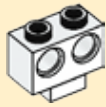

2x



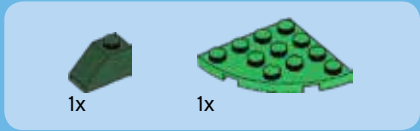

1



2



3



4





1x



1x

5



1x



1x

7



1x

6



1x



1x

8



1x



1x

9



1x

10



1x



1x

11



1x



1x

12





1x



1x



2x

13



1x



2x



2x



1x

14

1



2

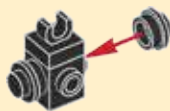

3

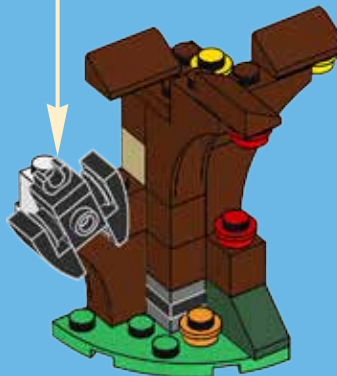

64





CREATOR

31039

LEGO and the LEGO logo are trademarks of the/son des marques de commerce du/son marcas registradas de LEGO Group. ©2015 The LEGO Group. 6127612 / 6127613



LEGO.com/creator



CREATOR

31038



LEGO.com/creator

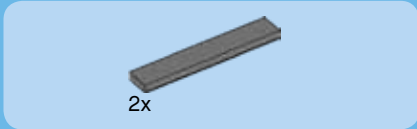
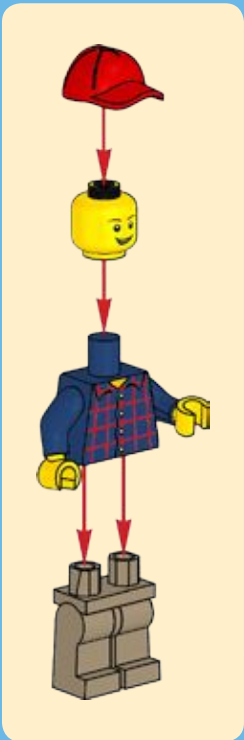

1

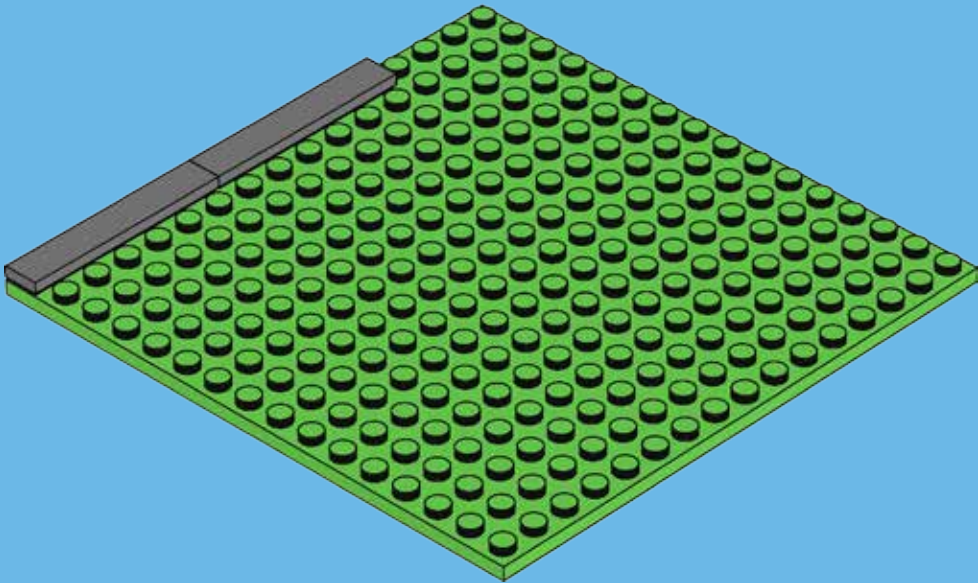



2

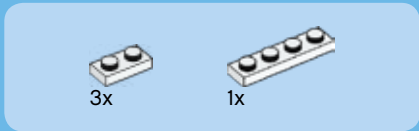
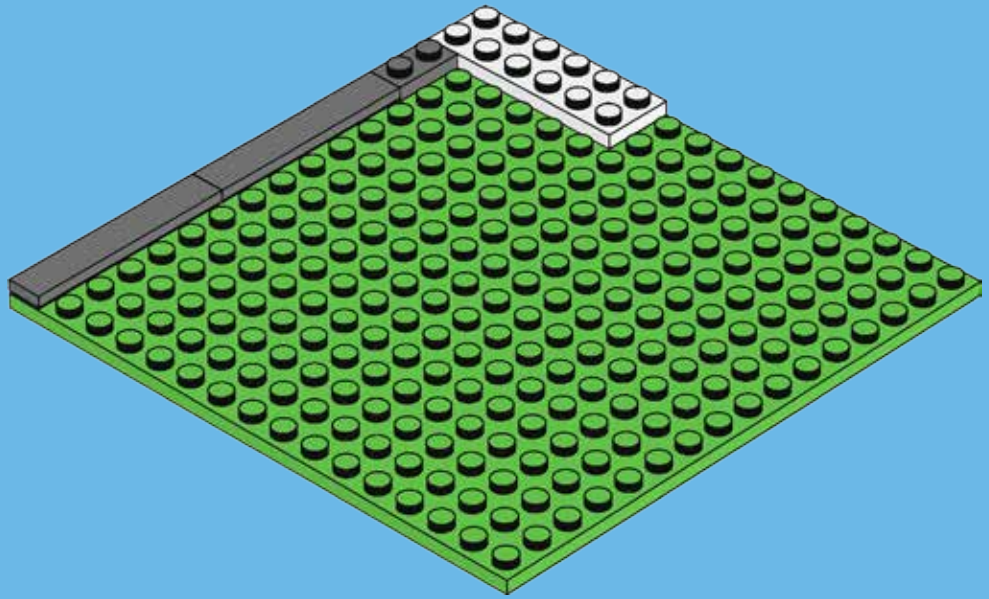

3

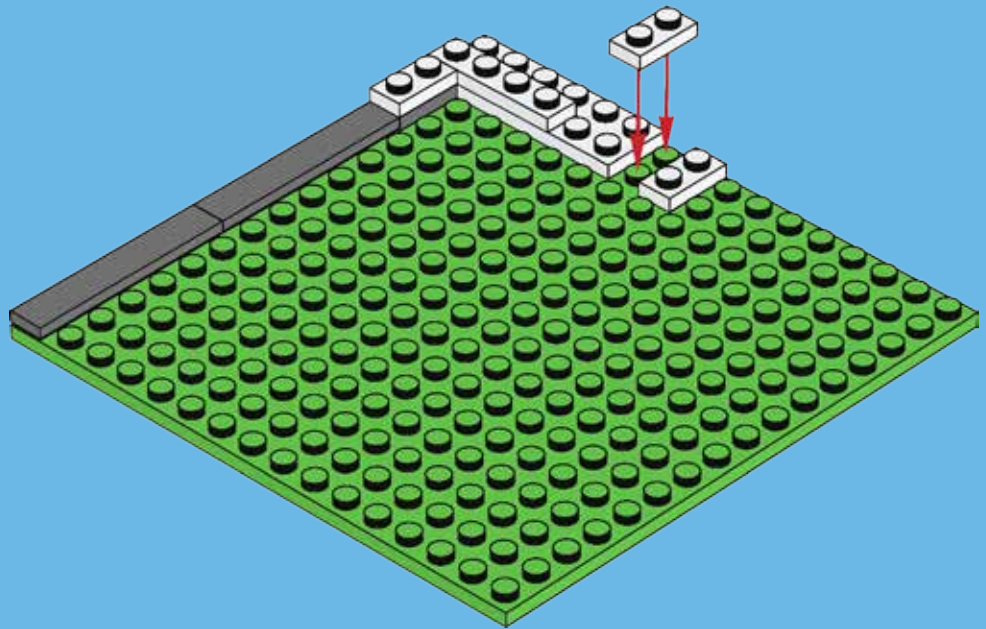



1x



2x



2x

4

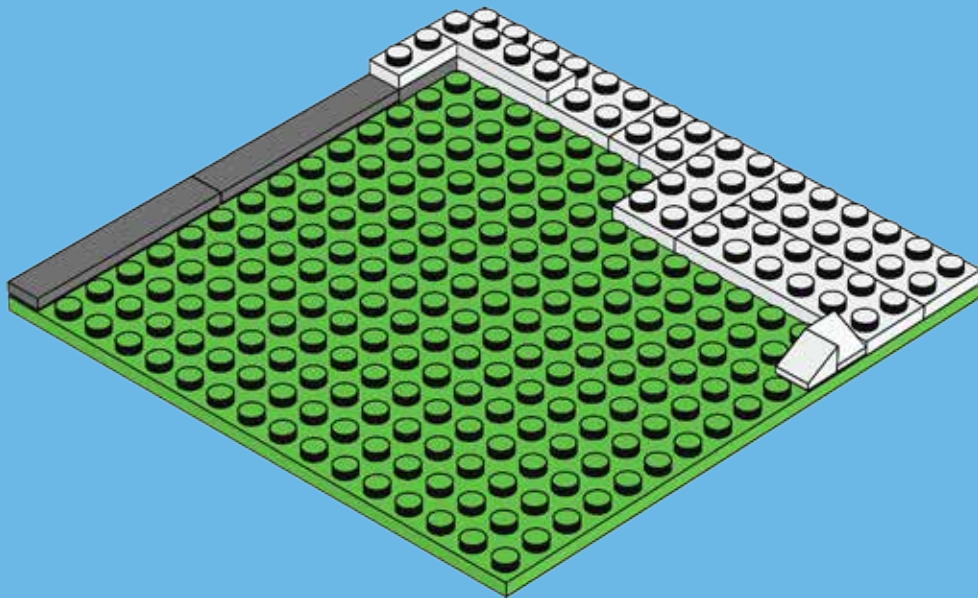



5

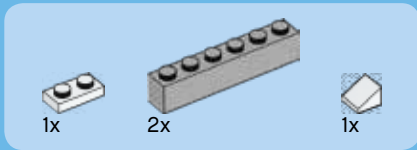
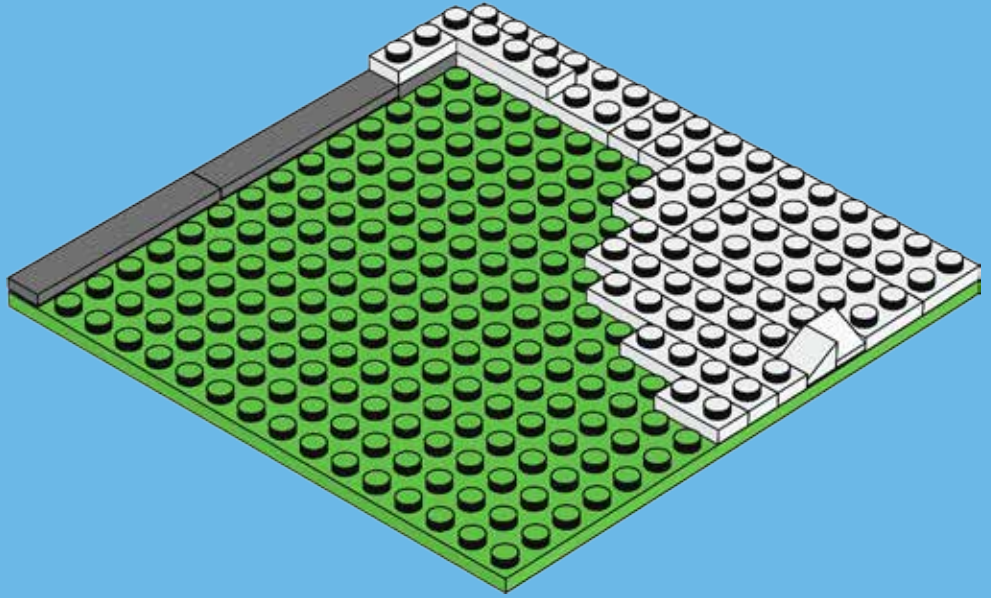

6

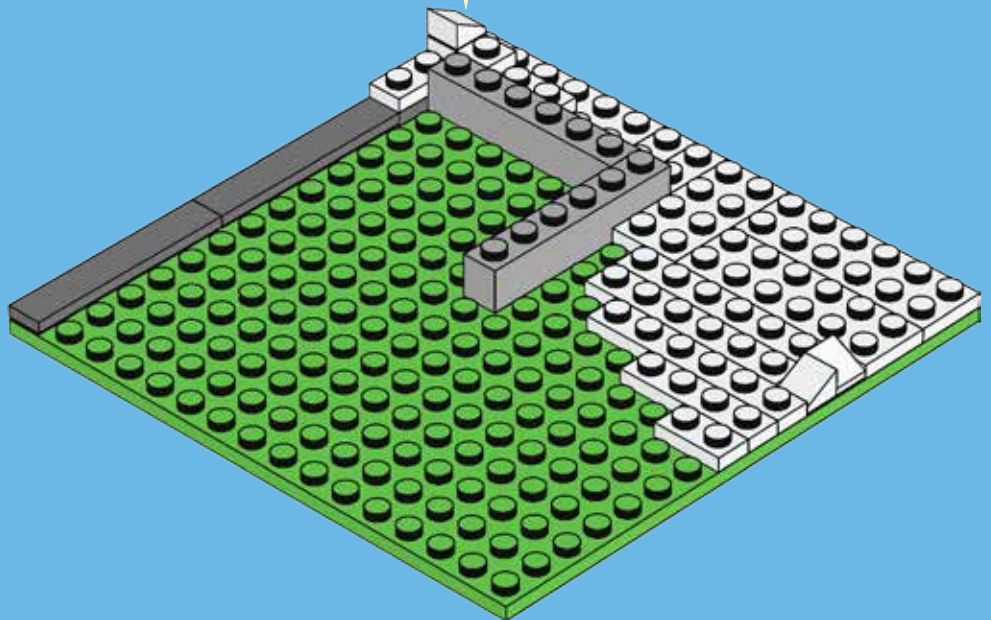
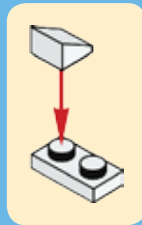



2x



1x



2x



2x

7

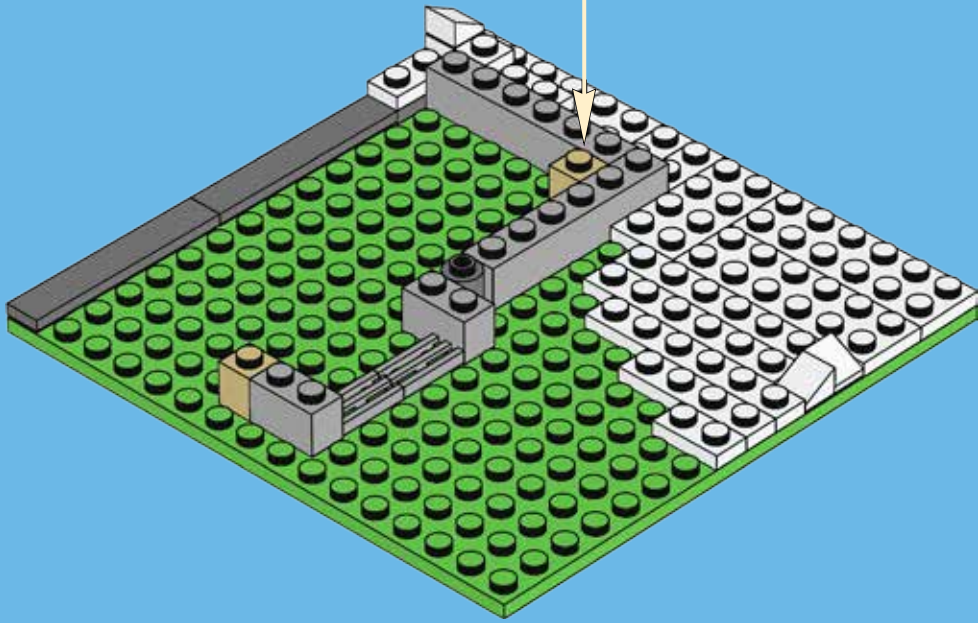



2x



1x

8

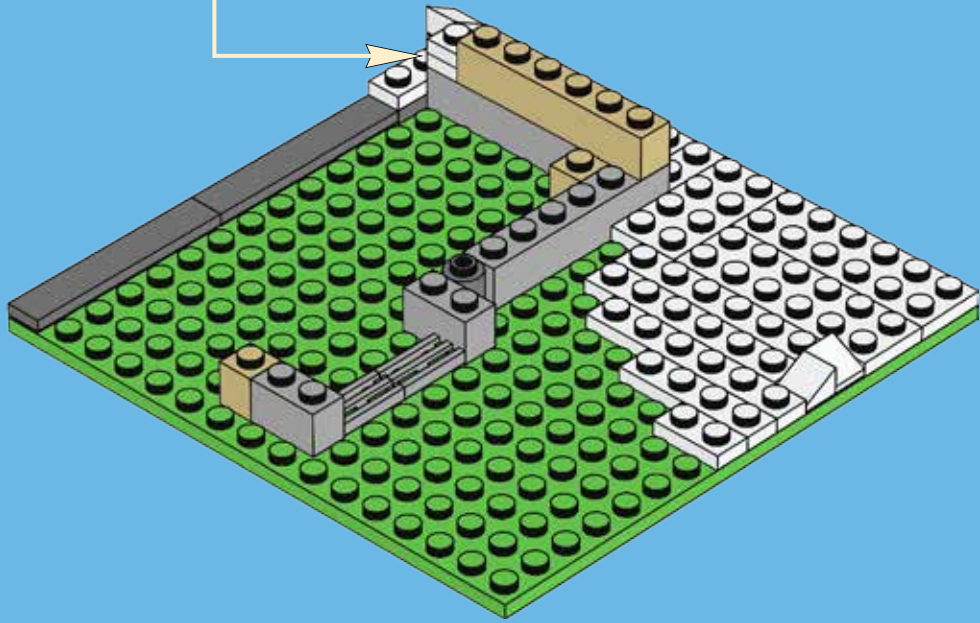
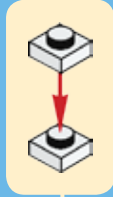



1x



1x



1x



2x

9

1

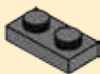

2



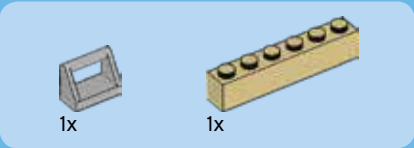

10

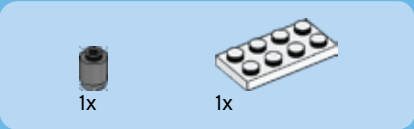

11



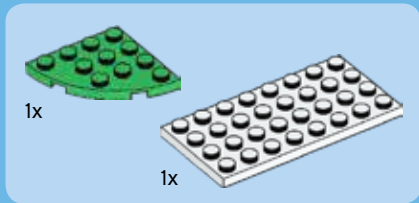

12





2x



3x

13



1x



2x



1x

14





1x

15





1x



1x

16



2x



3x



1x



5x

17



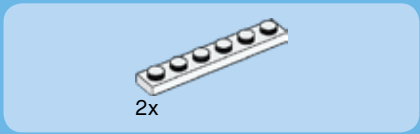
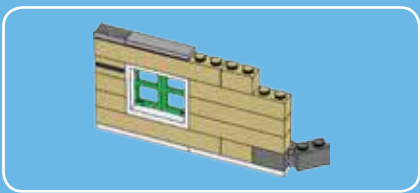

1

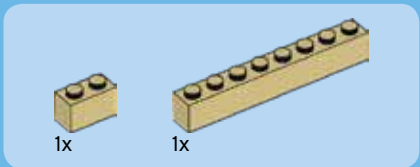
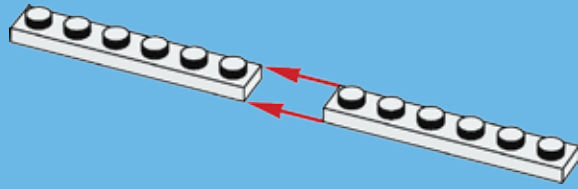

2

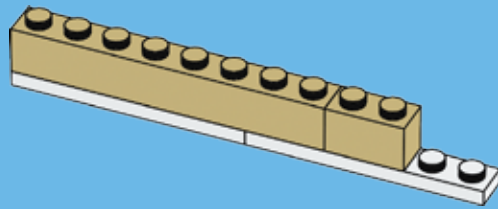



1x



1x

3

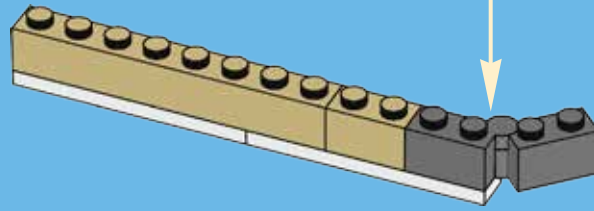
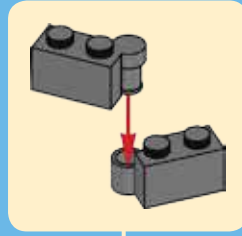

1x

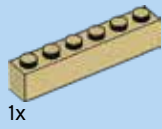

1x

4

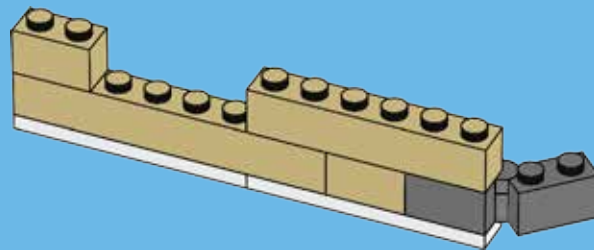

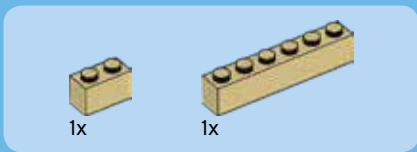

5

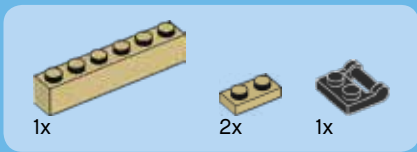
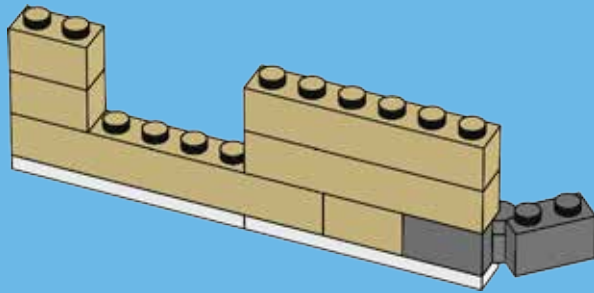

6

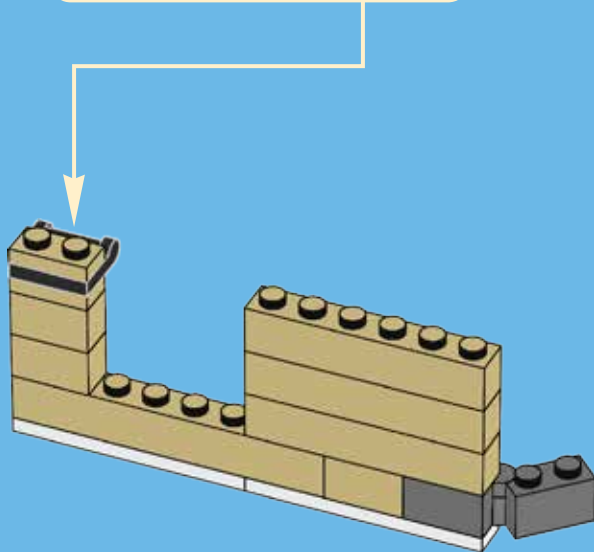
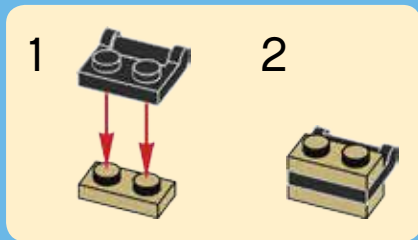

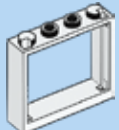

1x



2x

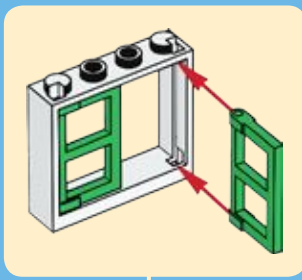

7

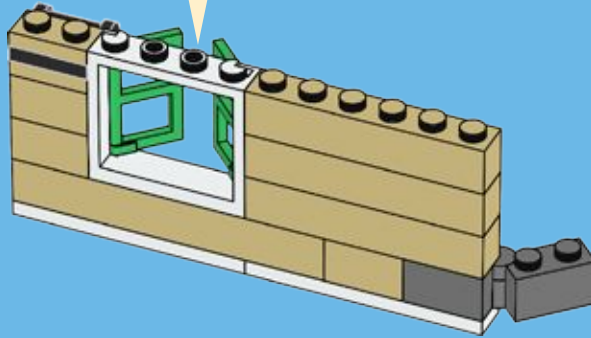

1x

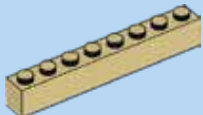

1x

8

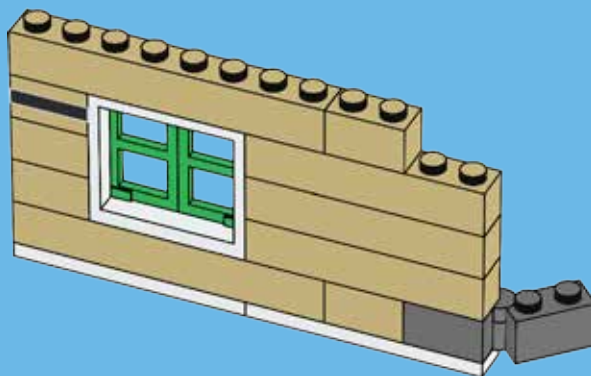



1x



1x

9

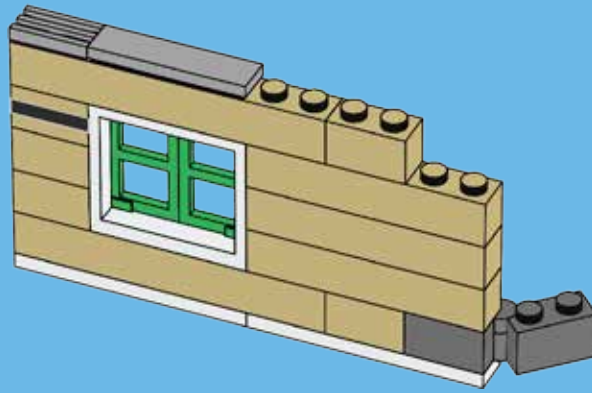

18





1x



2x



2x



1x



1x

19





1x



1x



2x

20





1x

1

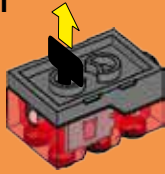

2



21





1x



2x



1x

22





23





2x



2x

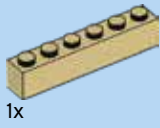

1x

24





25





1x



1x



2x



2x

26



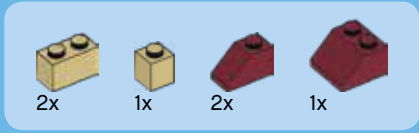

27



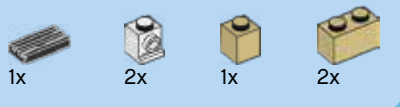

28

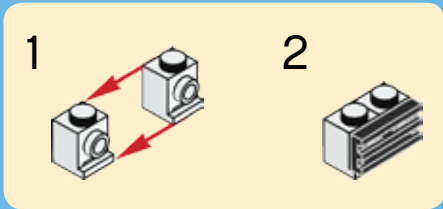



2x



4x



2x

29

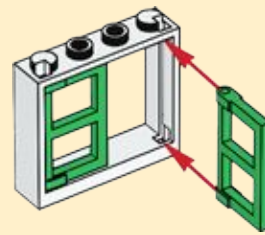

2x

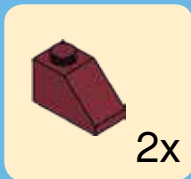

2x



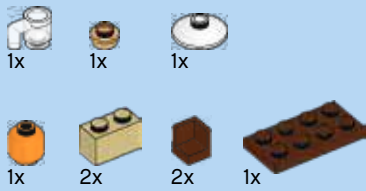

30

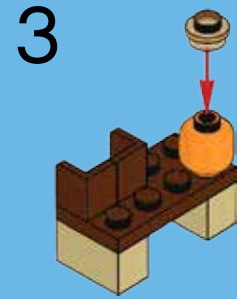
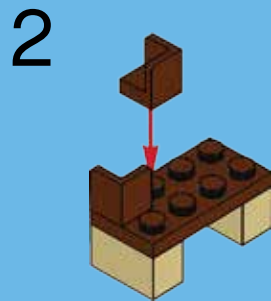
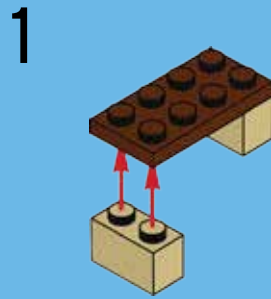



1x

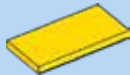

1x

31





32

1

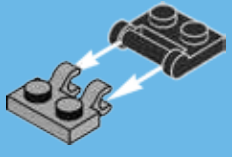

2



3



4



5



6



7





1x



1x



1x

33

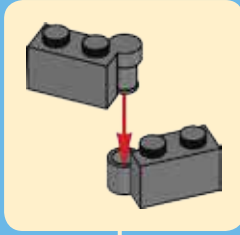

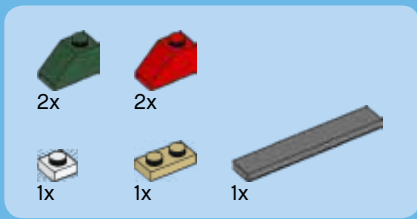

34



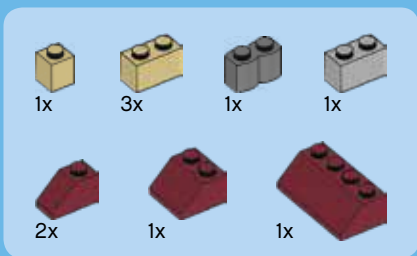

35



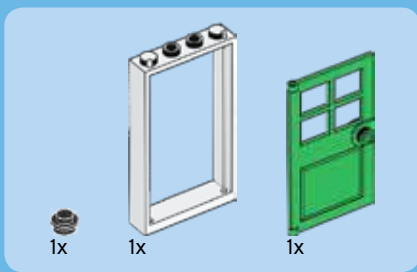

36

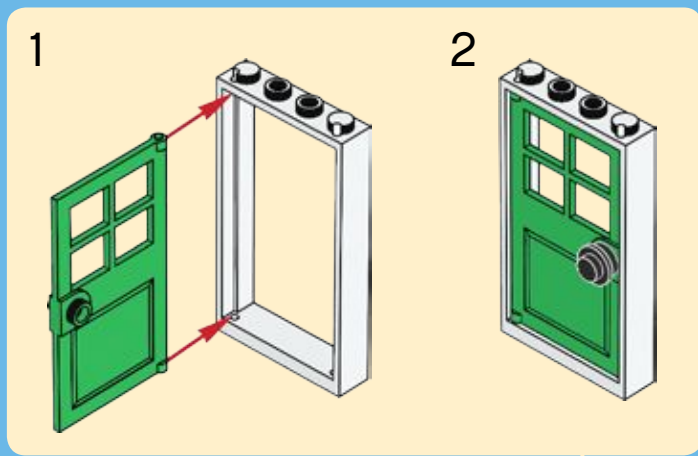

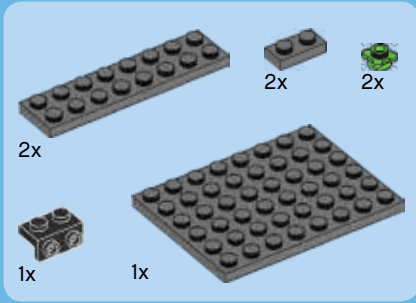

37

- 1 
- 2 



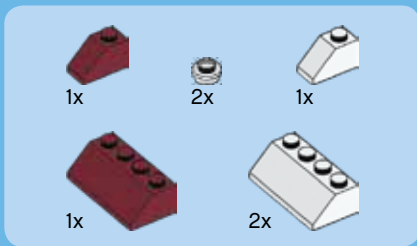

38

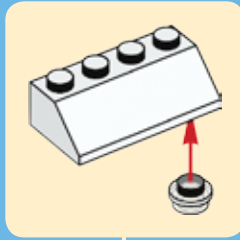
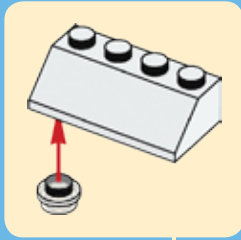



2x



2x



2x



1x

39

1

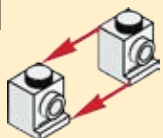

2

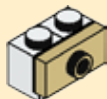



2x



1x



2x



1x

40





3x

41





2x



1x



2x



1x

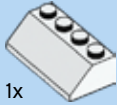

1x

42



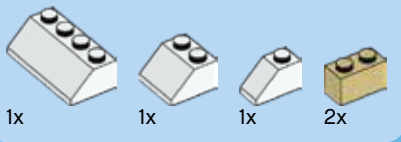

43



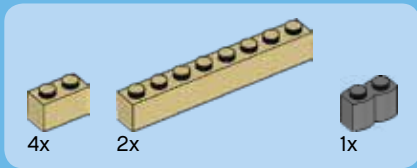

44



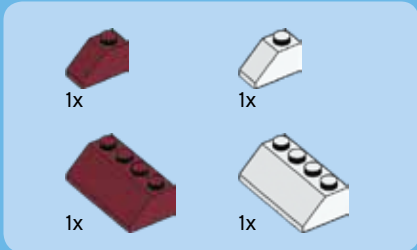

45





1x



1x



2x

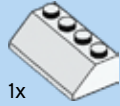

1x

46





47

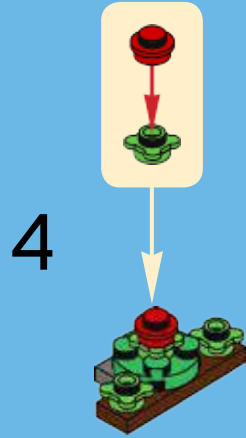
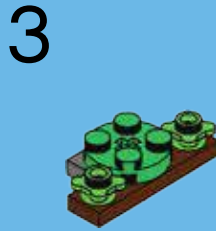
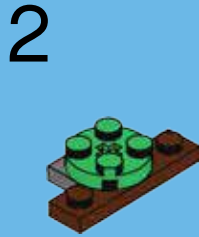
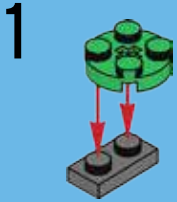



1x



1x



2x



1x

48



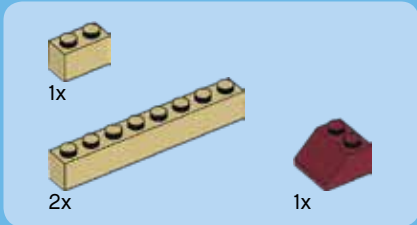

49





2x



2x



1x

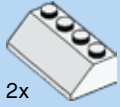

2x

50



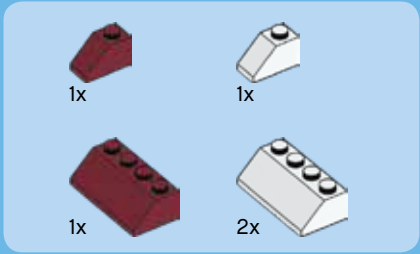

51



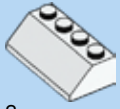

3x



3x

52



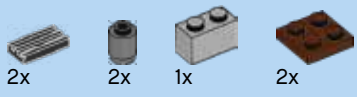

53

1



2



3



4



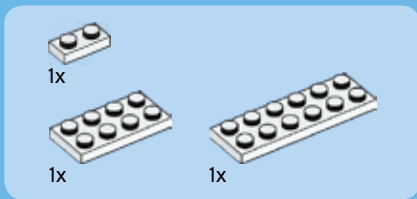

54





2x



4x



1x

55

1



2



3



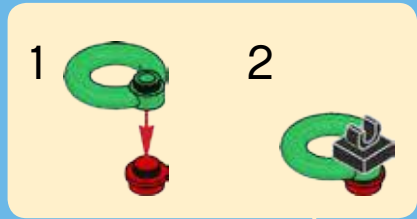
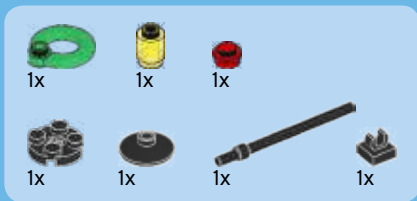

56

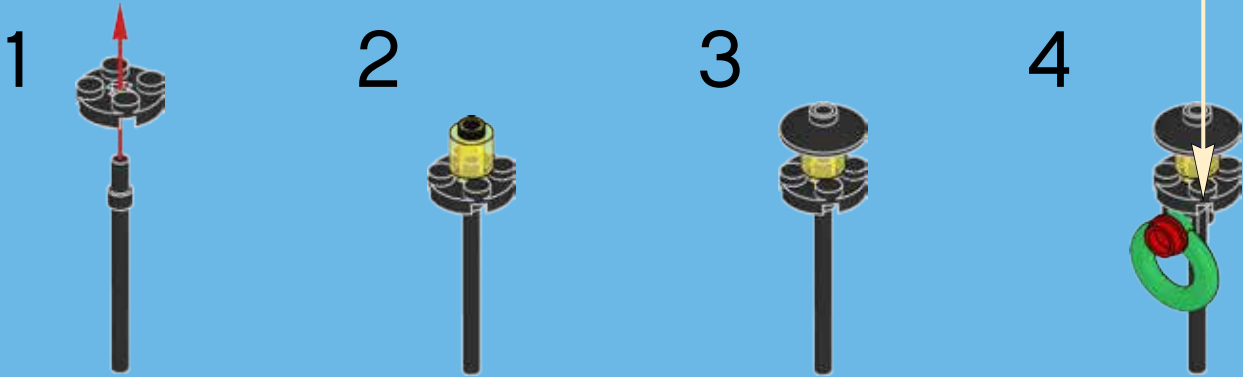



1x



1x

1



1x

2



1x



1x

3

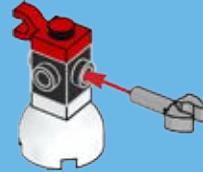

1x

4





1x



1x

5



1x



1x

6



57





1x

1

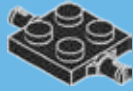

1x

2

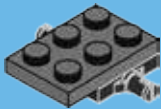

1x

3



1x

4



1x



1x

5



1x



1x



1x

6

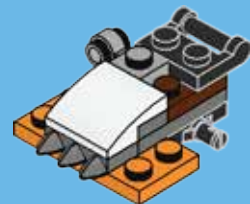



2x



1x

7

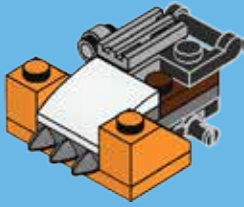

2x



1x

9

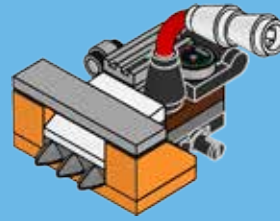

1



2

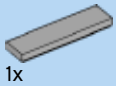

1x



1x



1x

8

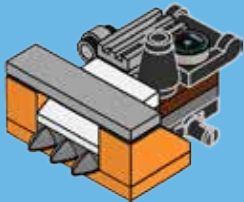

2x



2x

10



2x

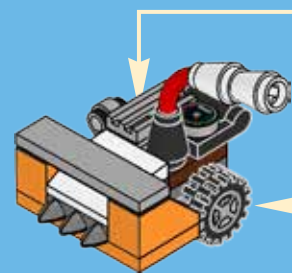

58



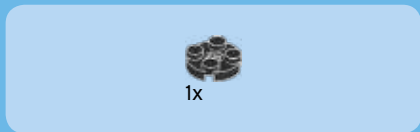
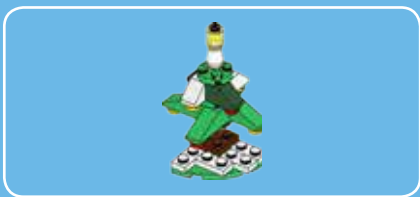

1

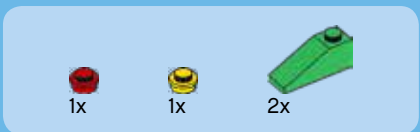

2

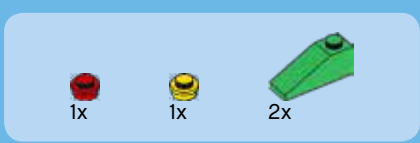
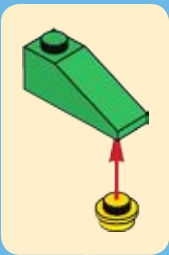
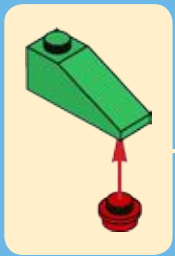

3

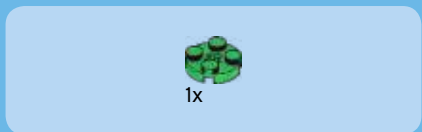
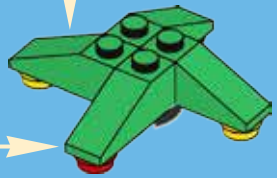
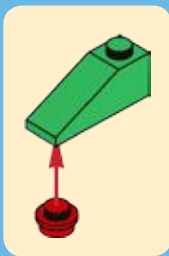
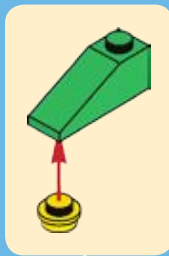

4

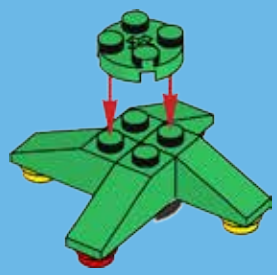



1x



1x



1x



1x

5

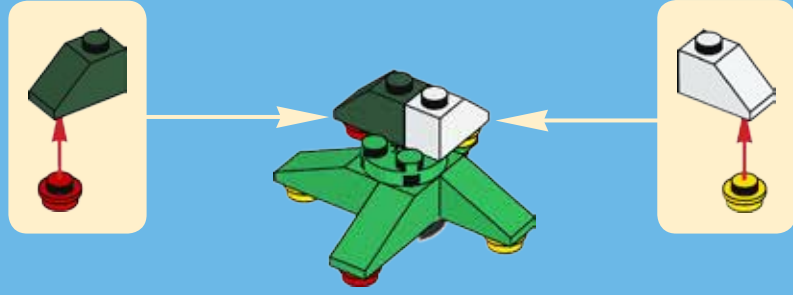

1x



1x



1x



1x

6





1x

7

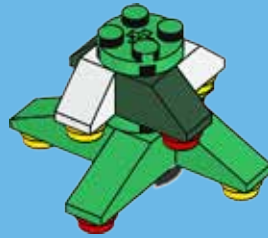

1x



1x



1x

8

1

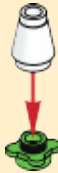

2



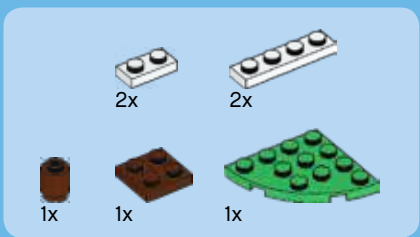

9

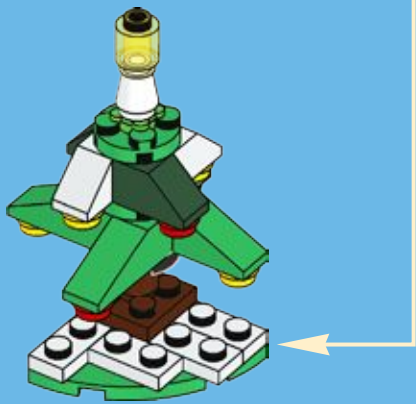
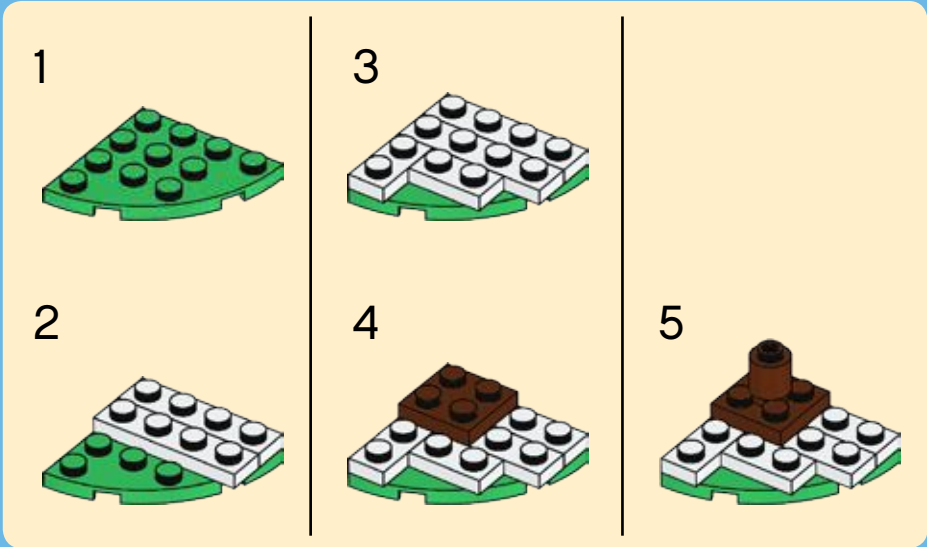

59



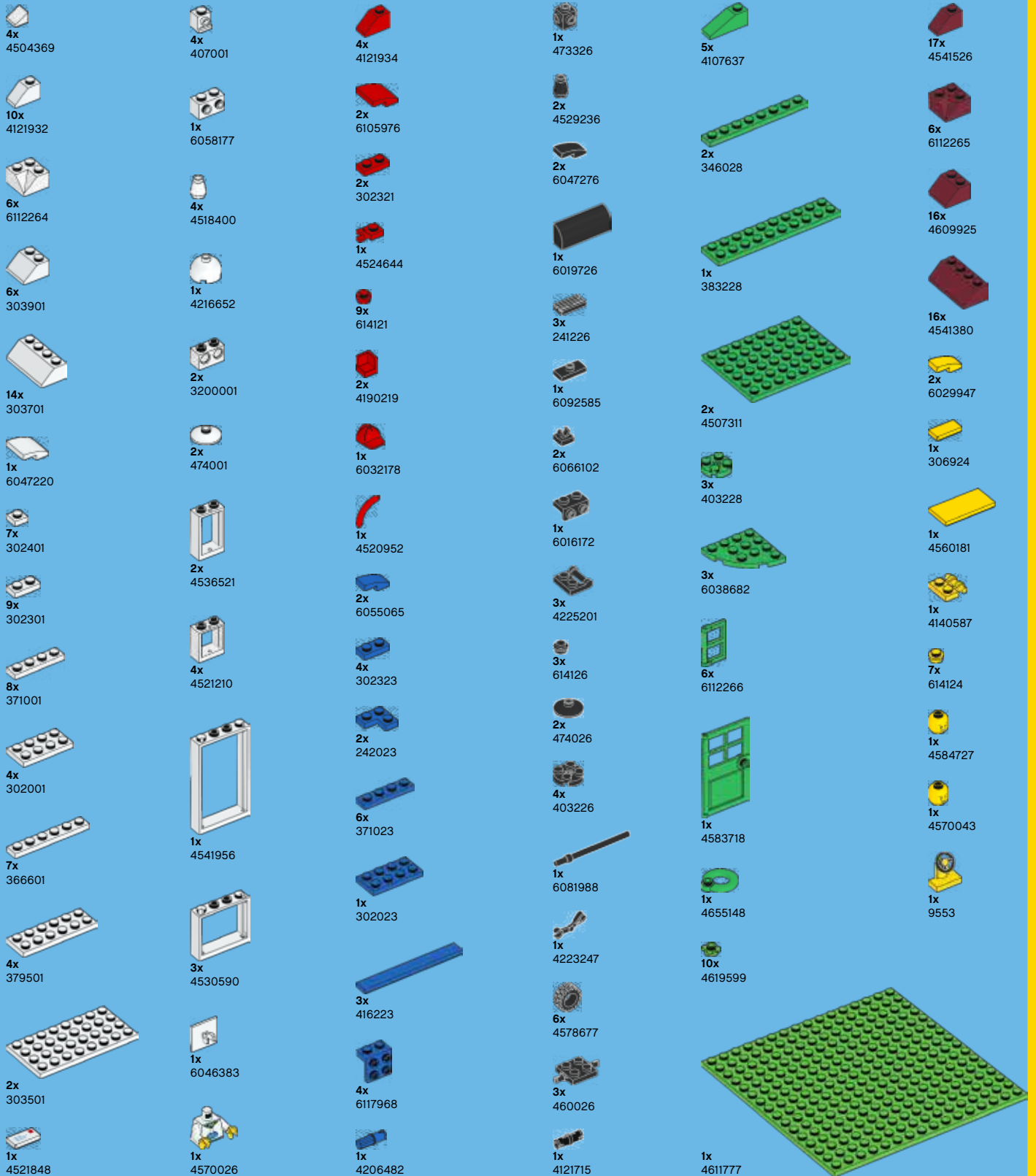

2x
3005740

4x
6024020

2x
4536998

1x
626440

2x
3000841

1x
6121786

2x
3006844

2x
4121967

1x
4158355

6x
4157103

1x
4511896

1x
4654448

1x
4124083

1x
4524098

1x
4275821

4x
4255624

26x
4113915

31x
4109995

5x
4114306

9x
4112982

8x
4159774

1x
6092587

4x
4113917

2x
4518557

1x
4581313

1x
6030333

1x
6031019

3x
6055086

8x
4216695

2x
4211190

3x
4211186

2x
4645400

1x
4211157

5x
4211200

5x
4211183

3x
6035291

7x
4211095

8x
4211090

7x
4211063

2x
4211043

3x
4210651

1x
4210998

2x
4210997

1x
4210794

3x
4587212

1x
6083980

2x
6011461

2x
4210795

12x
4211388

2x
4211393

5x
4211350

4x
4211356

4x
4632575

3x
4211357

1x
4556157

5x
4650260

1x
4211503

6x
4211506

1x
4258308

1x
4542590

3x
4222960

Customer Service
Kundenservice
Service Consommateurs
Servicio Al Consumidor

LEGO.com/service or dial

00800 5346 5555
1-800-422-5346



Friends

41101



41100



41098



EXPLORE. DISCOVER. CREATE. EXPLORE. DÉCOUVRIR. CRÉER.

EXPLORA. DESCUBRE. CREA.

LEGO.COM/worlds



LEGO WORLDS software © 2015 TT Games Ltd. Produced by TT Games under license from the LEGO Group. LEGO, the LEGO logo, the Brick and the Knob configurations and the Minifigure are trademarks of the LEGO Group. ©2015 The LEGO Group. All other trademarks and copyrights are the property of their respective owners.

Logiciel LEGO WORLDS © 2015 TT Games Publishing Ltd. Produit par TT Games sous licence du Groupe LEGO. LEGO, le logo LEGO, les configurations de briques et de tenons et la figurine sont des marques déposées du Groupe LEGO. ©2015 The LEGO Group. Les autres marques de commerce et copyrights appartiennent à leurs propriétaires respectifs.



Software LEGO WORLDS © 2015 TT Games Ltd. Editado por TT Games con licencia de The LEGO Group. LEGO, el logotipo de LEGO, el brick y la configuración de las espigas, así como la minifigura, son marcas comerciales de The LEGO Group. ©2015 The LEGO Group. El resto de marcas comerciales y derechos de autor pertenecen a sus respectivos propietarios.



WB GAMES LOGO, WB SHIELD:™ &
© Warner Bros. Entertainment Inc. (s15)



CREATOR



LEGO.com/creator

